

NAMMA TOILET

A High Quality Toilet Solution

Urbane Industries Limited
Chennai

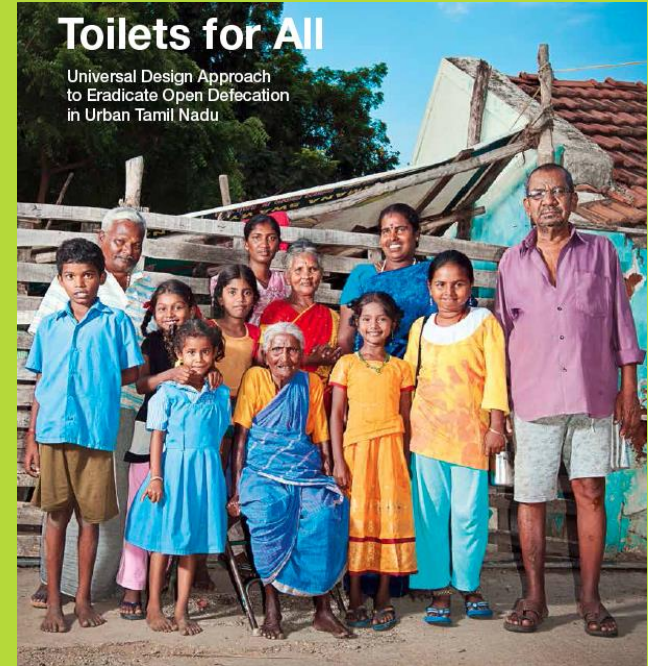

Introduction

- Namma Toilet is an initiative by the Commissionerate of Municipal Administration, Tamil Nadu along with participation of Urbane Industries Ltd to eradicate open defecation in the State
- The public and community toilets currently built by the government are rendered useless within a short period due to various reasons
- The mandate was to Design and Develop a User Friendly Universal Toilet which will be sustainable and should be successfully used by the people across all socio economic spectrum
- The product should be of very high quality and at the same time robust enough to withstand heavy footfall at public and tourist places

Approach to the Problem

- To arrive at a proper design a team of experts were formed from various fields
- People are the heart of the problem and require a collaborative, user- centered and practical approach to find the best ideas and solutions
- Teams to go to the source of the problem with focus on user needs and motivations
- It is with this objective the National Institute of Design (NID) Ahmadabad was engaged to understand problems of the actual user
- NID is an Internationally acclaimed and one of the foremost multi-disciplinary institution in the field of design education in India

Approach to the Problem

- A Cultural Appropriateness Study was conducted by NID to understand the problem from the user's point of view across the state
- The study highlighted cultural issues around open defecation practices and the use of community and public toilets
- A team of experts conducted the study over four weeks in Anakaputhur, Trichy and Kanchipuram in Tami Nadu
- The study included in-depth interviews, full scale simulation and trace study to understand the different cultural needs
- To understand the current issues in existing facilities in-depth interviews were done to identify core issues

NID Key Findings

Open defecation is not a choice it is unfortunately a compulsion

NID's Findings established a need for

- 1) “ Universal Design” : Toilets designed to suit the needs of Men, Women, Children, Elderly and the Physically Challenged
- 2) Modular stall design for various formats so that the toilet stalls can be combined or separated to offer many scalable options to suit the site size and shape
- 3) Toilets to be efficient with good technology, adequate space, proper ventilation, supply of water at all times and independent power

The Design

Design addresses the most basic needs with additional high quality facilities:

- Ease of access with the right amount of privacy and safety by use of front canopies which can also be used for advertisement and signage
- Excellent interior lighting with natural light in day by a polycarbonate translucent roof sheet with metal protection and with timer controlled Solar powered Led lights in the night
- Smell free toilets due to abundant louvers for easy passage of fresh air at all times from the door to the top most positioned louvers
- International quality surface finish for ease of maintenance, anti graffiti and also this surface prevents smell generating bacteria from surviving on the inner wall surfaces, this is one of the key behind smell free toilets

The Design

- Modular design to fit various site sizes, shapes and user requirement
- Modules made of composite materials for ease of installation at a very short period even in hilly terrain and remote places
- High quality vandal proof fittings to ensure the user has a very pleasant experience
- Concealed plumbing with independent water tank and a room under the water tank for the maintenance staff and the material used for maintenance
- Rounded edges to prevent accumulation of dirt and grime and also for easy cleaning

The Design

- Flushing system in all the stalls with a five litre capacity tank to ensure proper cleaning of the pan after the use
- Privacy for Ladies with separate entrance and a provision for hygienic disposal of sanitary napkins
- Provision of stand alone wash basin with soap dispenser to promote hand wash habit and ensure hygiene
- Provision for Solar powered street light to light up the full complex to ensure a secure feeling for all users and also to prevent illegal activities during night
- Universal and standard signage with logo for common identification and uniformity across the whole country

The Stages of Progress

- The design started in May 2012 and was finalised by November 2012
- The first prototype was made in January 2013
- The first prototype was inspected by Dr. Ray, Professor and Head of the Industrial Design, IIT Mumbai
- With a few suggestions the product was cleared for initial public use and study by Dr. Ray
- The first installation was in Tambaram a suburb of Chennai in a highly crowded bus terminus in February 2013
- Everyday about 1200 people use four toilets installed there and even now it is like a new installation after two years and five months

The Stages of Progress

- Seeing the success in Tambaram it was decided by the government to install in a religious place which is also a tourist spot and Srirangam in Trichy was selected
- The installation was made in May 2013 and here also it was a great success
- After this to further see the performance of the product in a popular tourist spot Ooty was chosen and installation was done at three popular places in September 2013
- Here also it was a success and finally it was decided in November 2013 that Namma Toilet will be installed all over Tamil Nadu
- Currently we have supplied to 200 locations and completed installation in over 150 places comprising of about 800 toilet modules
- This project has been received well by the media and the public

THE DESIGN

Views of single stall

Front View

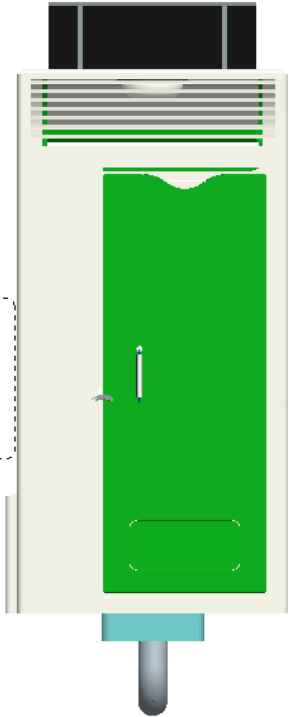

Side View

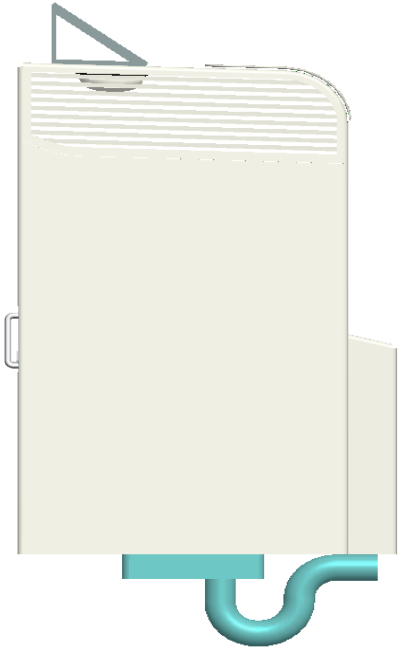

Top View

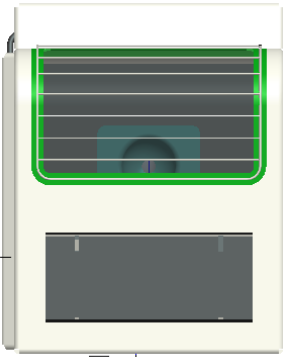

sustainable
toilet solutions

Isometric views of Single stall

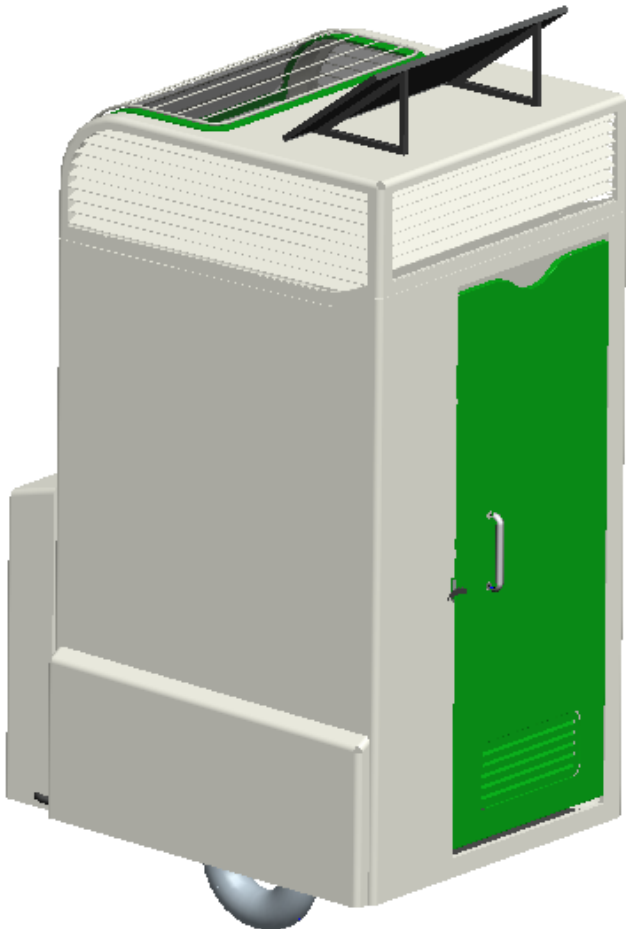

Water tap with bucket



Door handle and barrel bolt with throw over latch

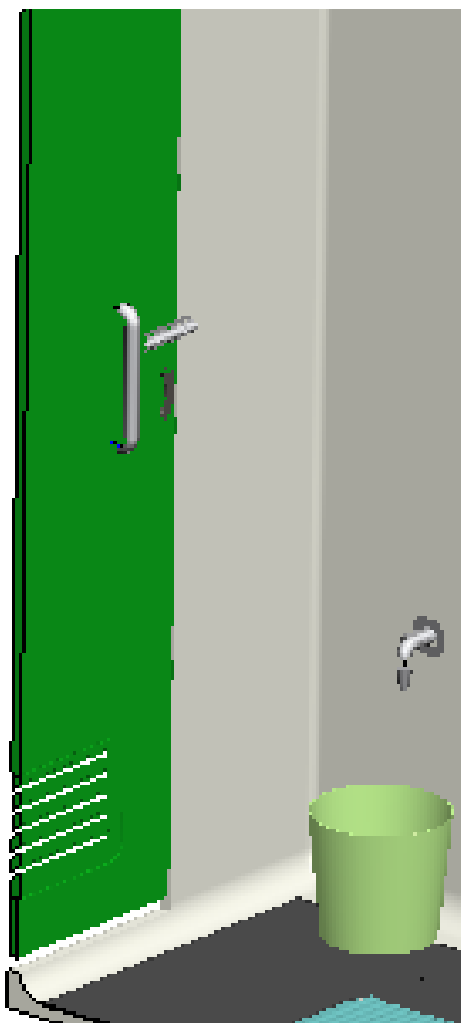
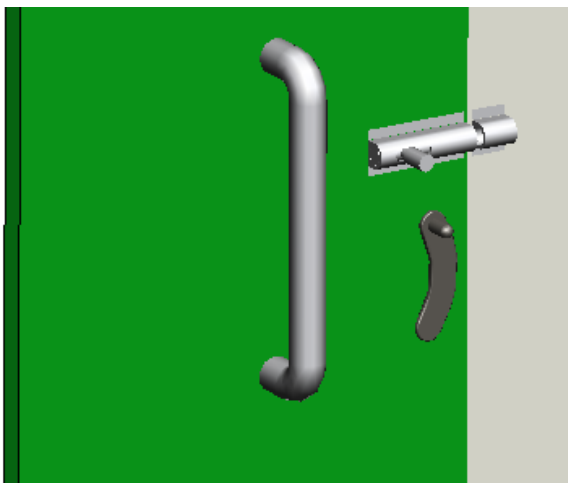
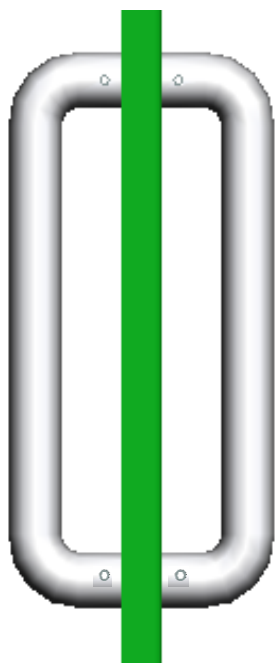

Flush tank arrangement at the back with piping and P trap view

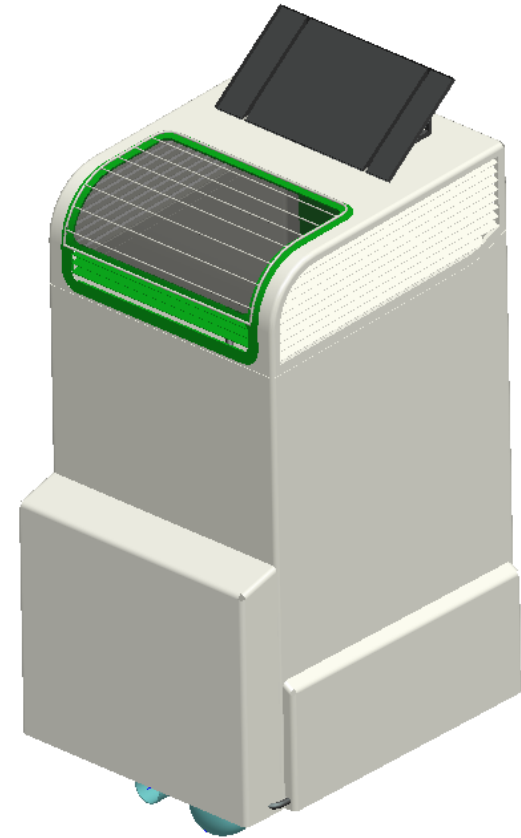
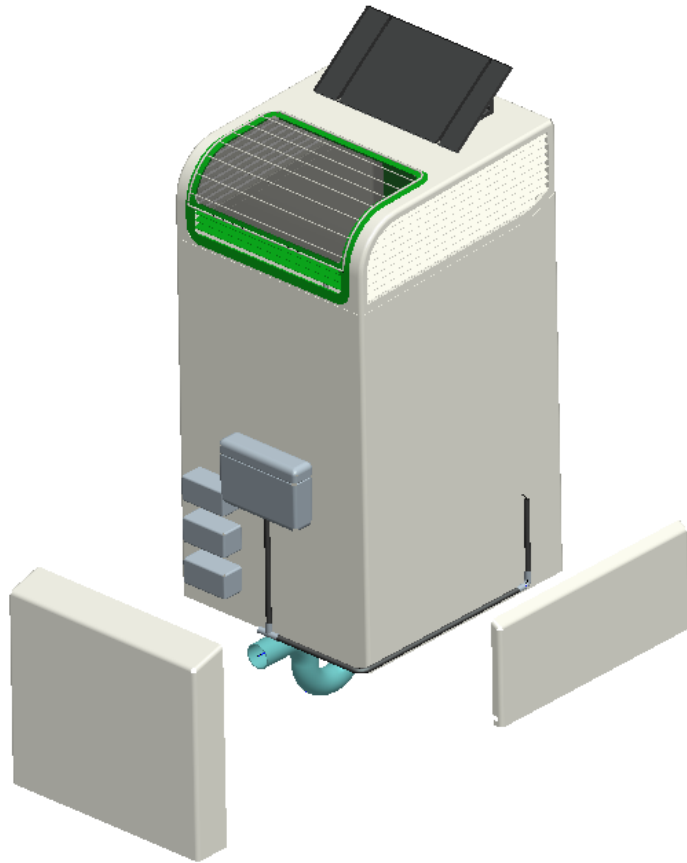

Concealed flush arrangement with flush knob

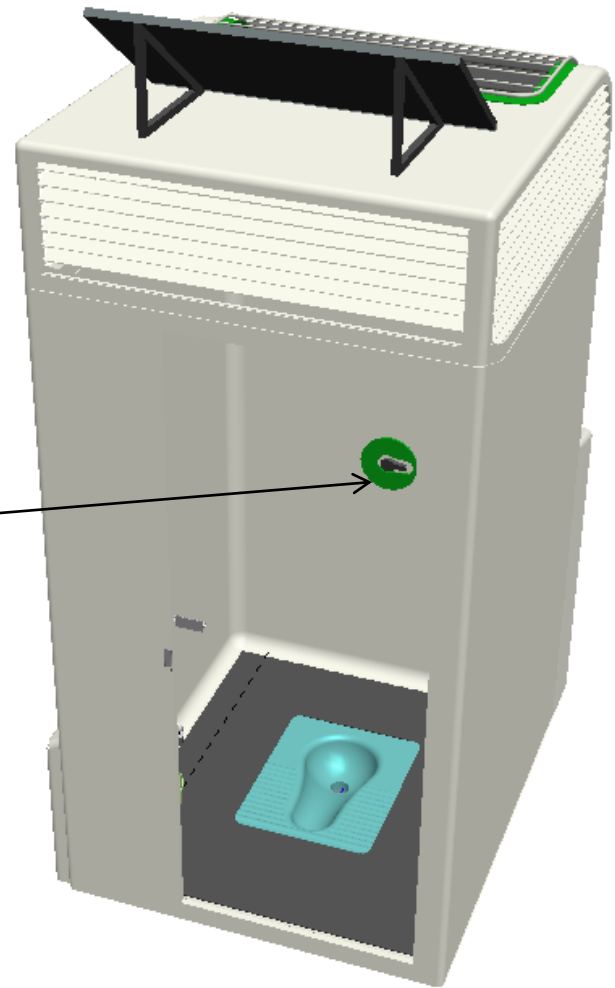
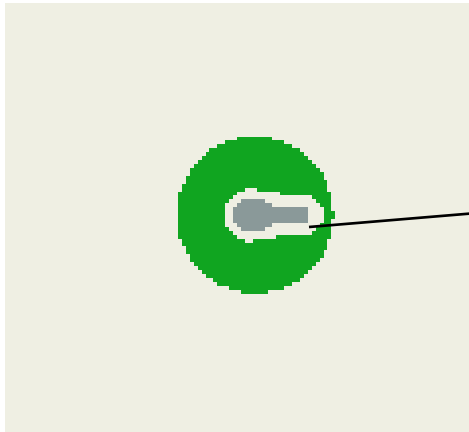
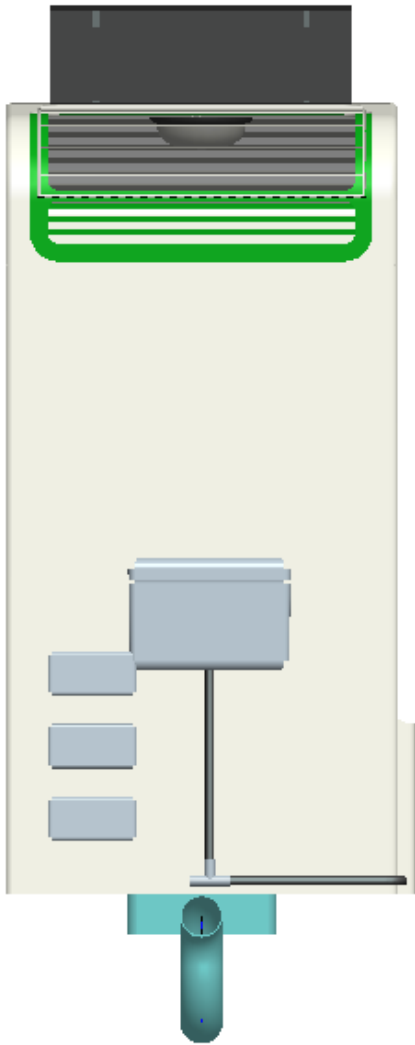

Hatched view of interior

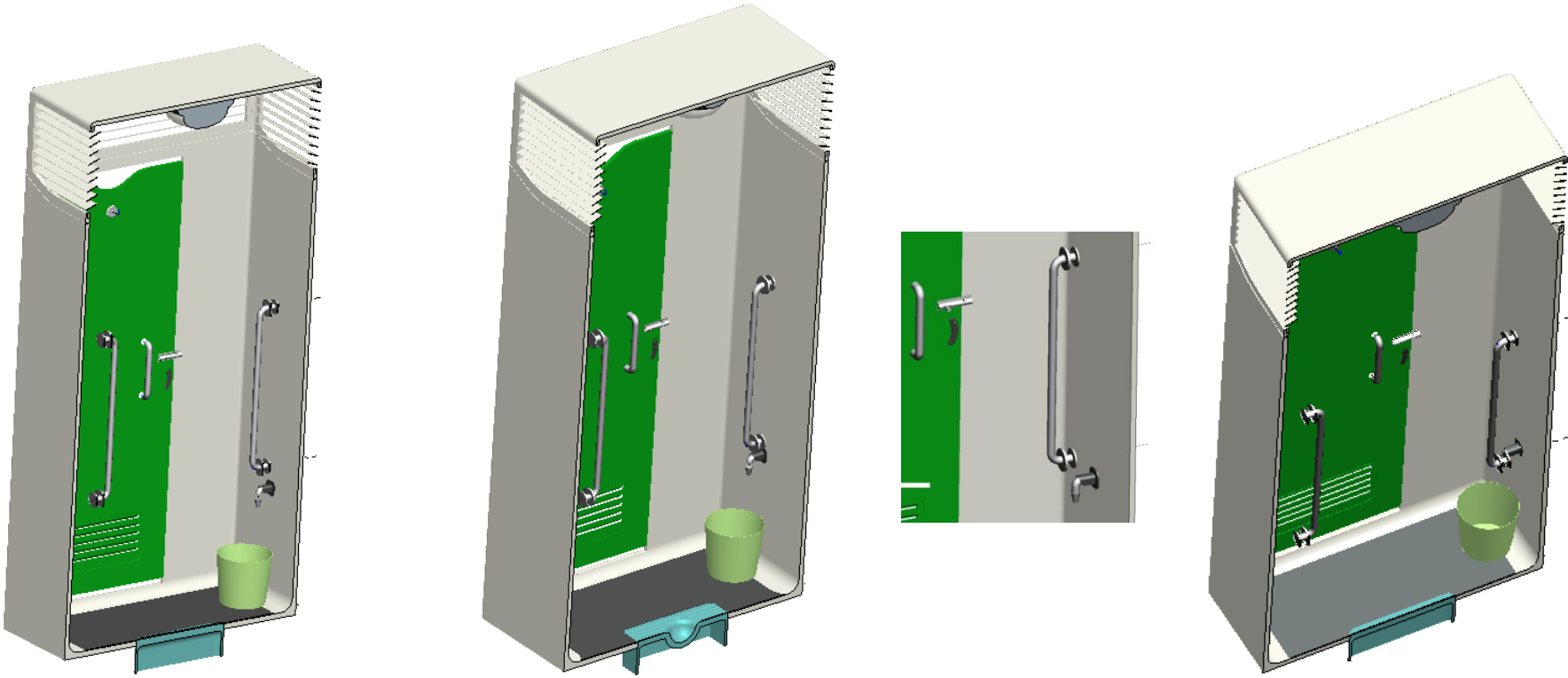

Solar panel for lighting exploded views

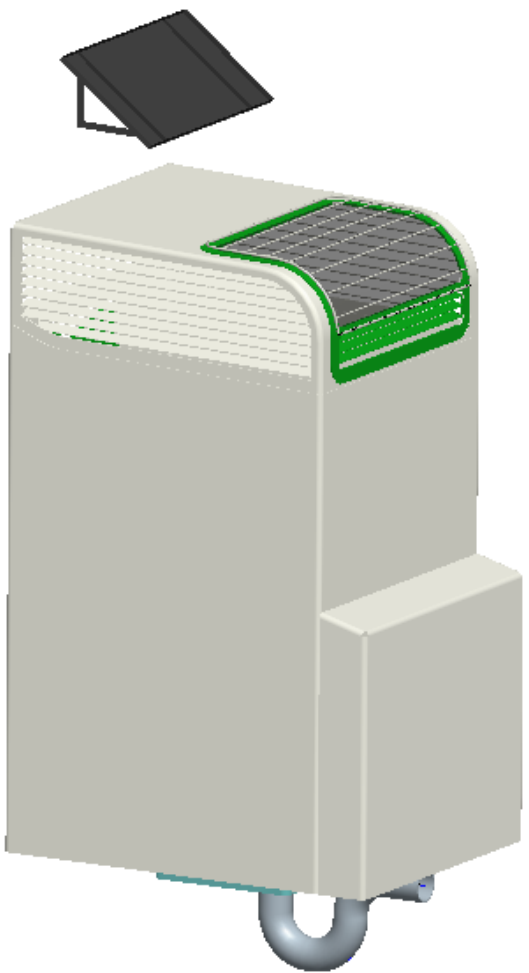

Overall toilet exploded views

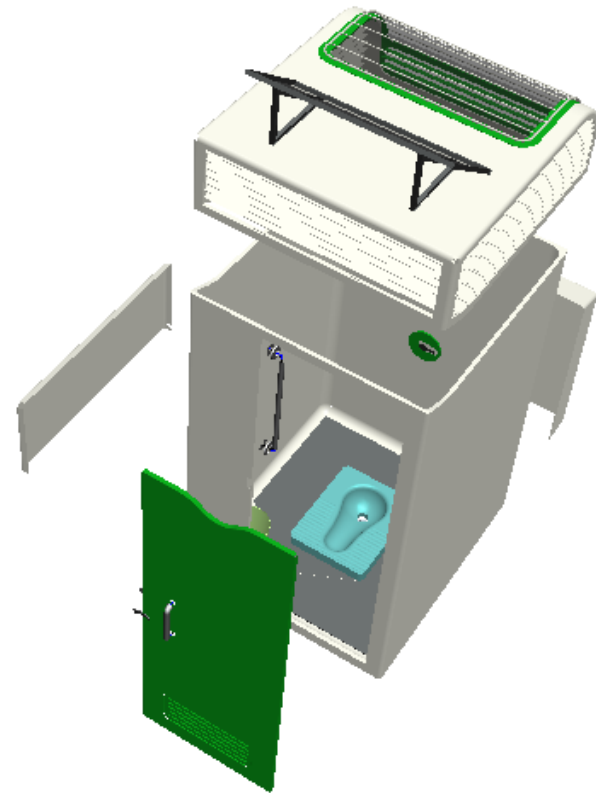
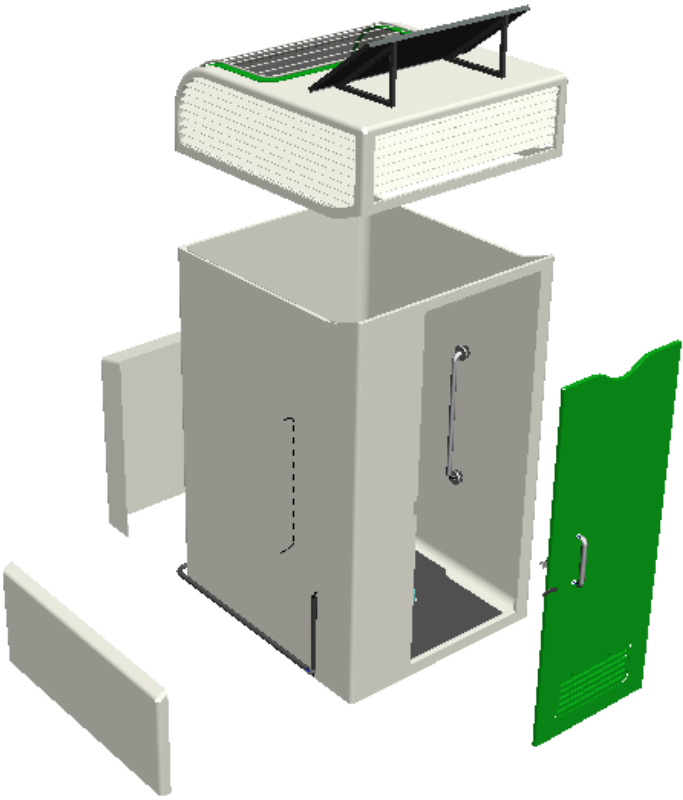

The Product

Namma Toilet: 1 Physically Challenged Plus two Regular Toilets Complex at SRIRANGAM Trichy



Namma Toilet: Physically Challenged Toilet View

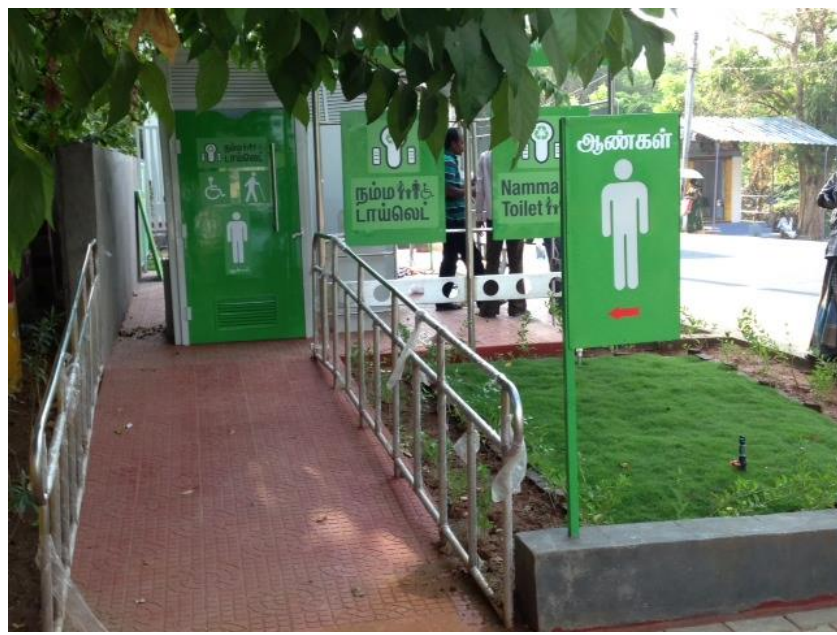

Tank with cabin for maintenance

Ooty outside Botanical Gardens View



Chennai Corporation: Men + Women with Urinal

Urinal



Chennai Corporation: 1PC + 2Men + 1 PC + 2Women with extended Ramp



Interior View – Concealed piping with Pilfer proof tap



Natural Light ventilation through Poly carbonate roof



Natural air ventilation with provision of abundant Louvre arrangement

Interior View – LED Light with Motion control



Robust door with coat hook



Interior View – Grab Bar



Curved corners to ensure very clean surface and easy to clean

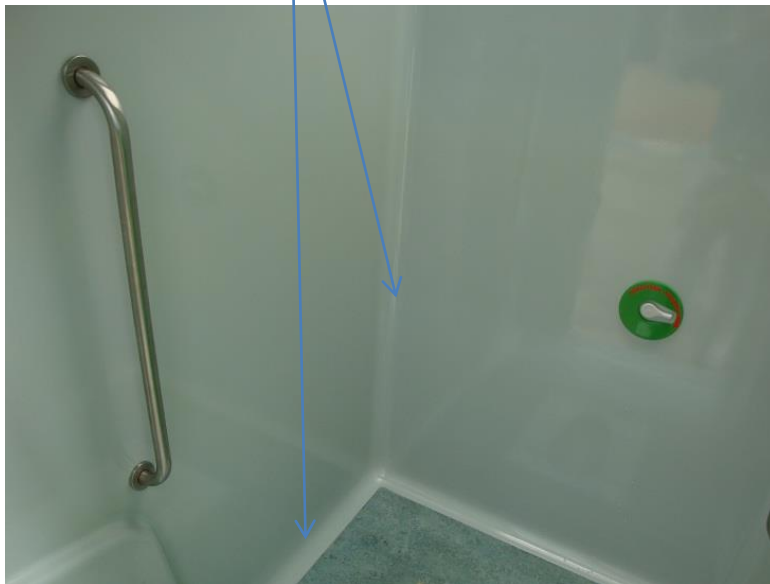

Ladies Toilet – Sanitary Disposal arrangement with instructions

Concealed flushing arrangement to ensure the toilet pan is always clean



sustainable
toilet solutions

Namma Toilet Men Urinal

picture



Urinal inside view



sustainable
toilet solutions

Namma Toilet various configurations

Configuration – 1Req Men + 1 Req Women

	1	2	3	4	5	6	7	8	
DRAWING NUMBER NT-UI-001		REGULAR MODEL WOMEN 1 MEN 1				ALT. NO.		ALTERATION	DATE
ALT									
A									A
B									B
C									C
D									D
E									E
F									F
1	2	3	4	5	6	7	8	A3	

SOLAR LIGHTING SYSTEM AS REQUIRED

SLNO	DETAIL	QTY	REF.DWG	MAT.&SPEC.	WEIGHT/UNIT
16	TRUSS	-		ASPER-COMPOSITE	
15	OUT-STRUCTURES	1		M.S.COMPOSITE	
14	WATER TANK 2000 LITRES	1		IBPP	
13	DOOR SID	2		M.S.PEEL	
12	DIJECTION BOARD	2		M.S.COMPOSITE	
11	S.S. RAILINGS FOR PC	-		ASPER	
10	M.S. PARTITION WITH COMPOSITE PANEL	1		M.S.PEEL	
9	M.S. CHAMBER PARTITION	2		M.S.PEEL	
8	PARTITION FRAME FOR PC (CANOPY)	-		ASPER-COMPOSITE	
7	PARTITION FRAME FRONT (CANOPY)	1		ASPER-COMPOSITE	
6	WASH BASIN WITH SOAP DISPENSOR	2		COMPOSITE-BASIN	
5	SOLAR POWERED STREET LIGHT	2		-	
4	SOLAR PANEL WITH LED LIGHT	2		-	
3	MISG MODULAR ROW TOILET STALL	1		COMPOSITE	
2	WOMEN MODULAR ROW TOILET STALL	1		COMPOSITE	
1	P.C. MODULAR TOILET STALL	-		COMPOSITE	

SUPERSEDED BY:		DRN	R. MAHENDRAN
SUPERSEDED BY:		CHC	N. MAHESH
DRAWING NAME		APC	R. K. M.
NAMMA TOILET		DRAWING NUMBER	
1 REG MEN + 1 REG WOMEN		NT-UI-001	
COMMISSIONERATE OF MUNICIPAL ADMINISTRATION, CHEPAAU CHENNAI - 600005		SCALE	0.025
		SHEET	A3
		OF	
		ALT	

sustainable

toilet solutions



Configuration – 1Req Men + 1 Req Women + 1 Urinal

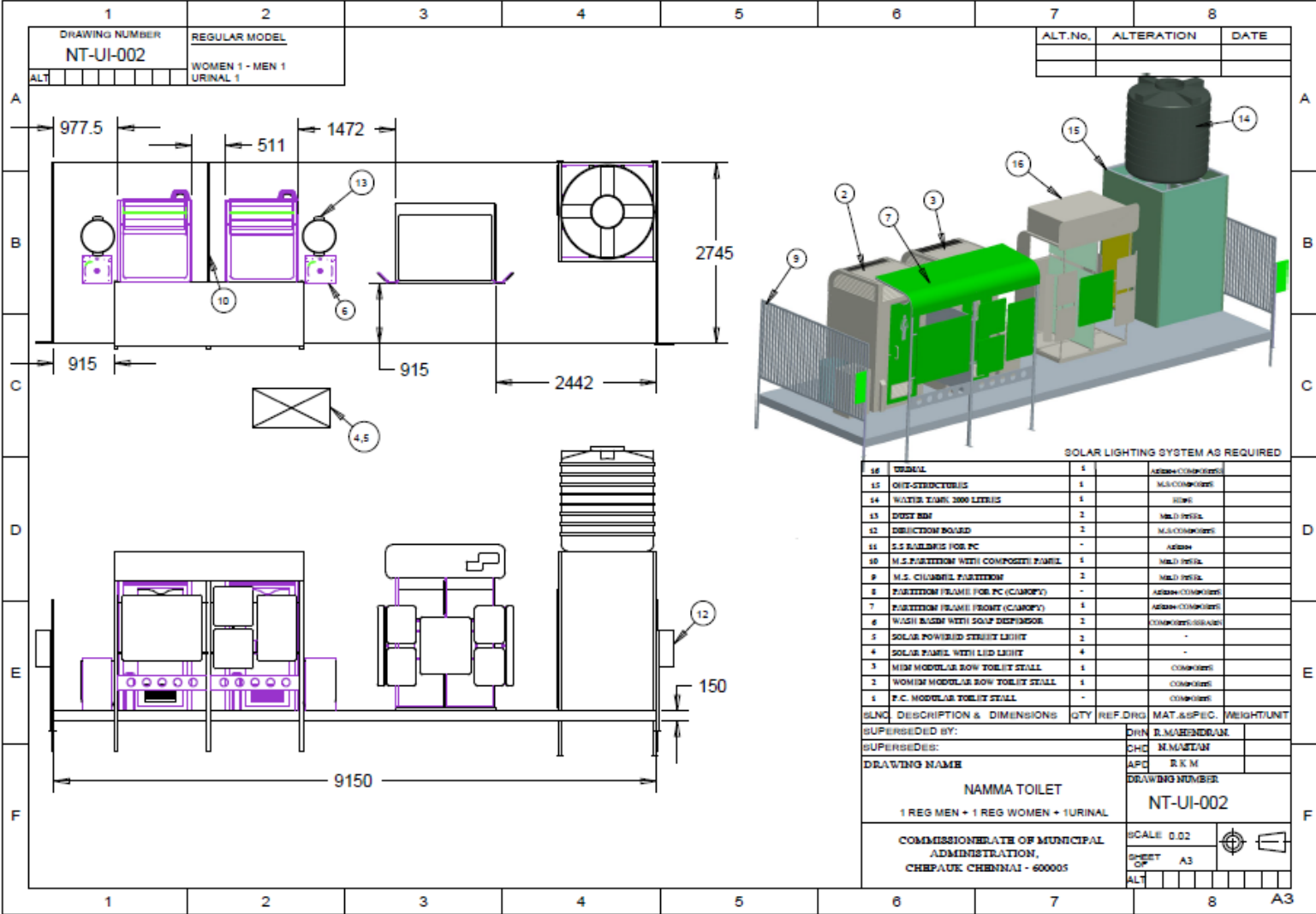

sustainable

toilet solutions



Configuration – 1Req Men + 1 Req Women + 2 Urinals

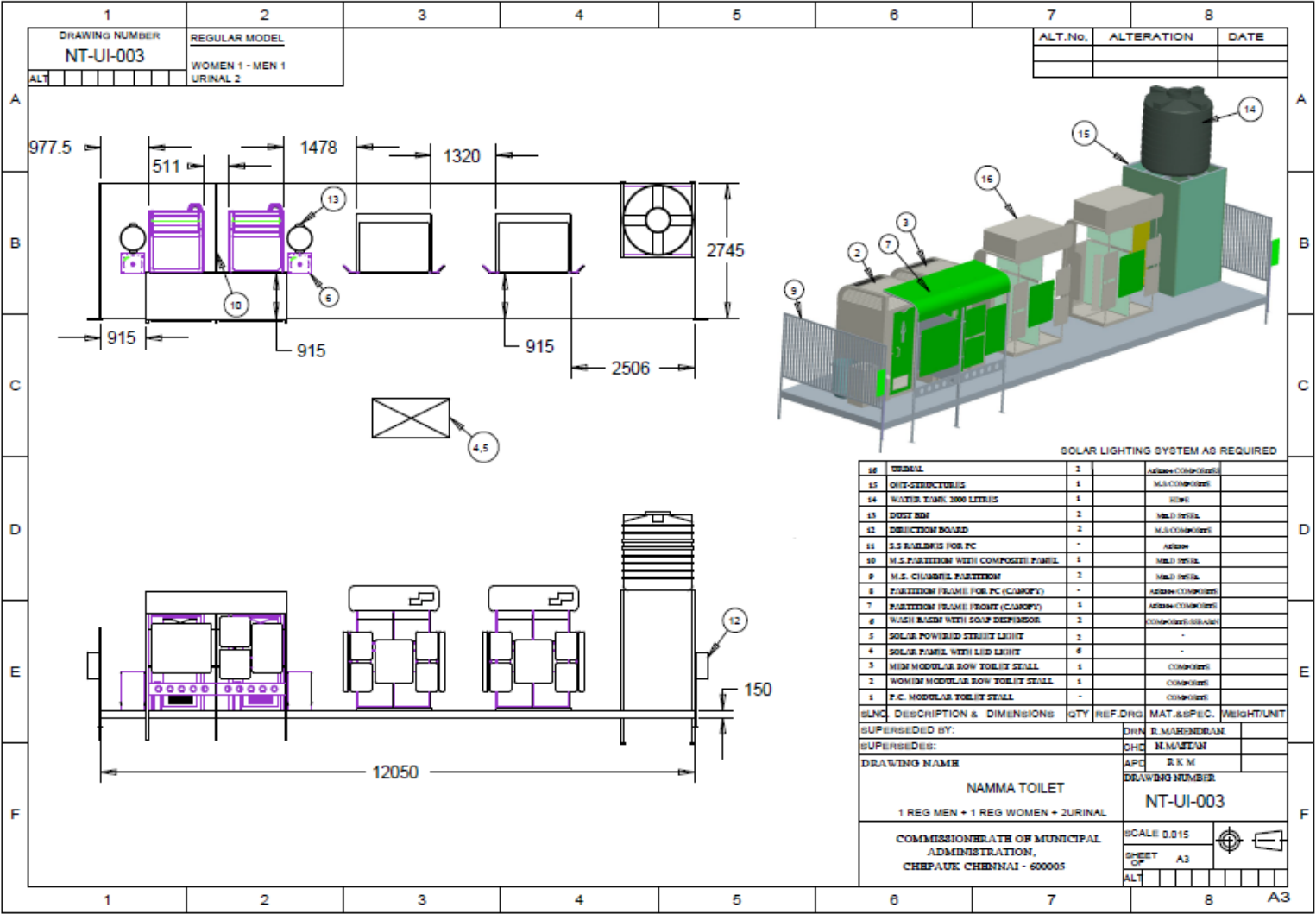

sustainable
toilet solutions



Configuration – 1PC + 2 Req M

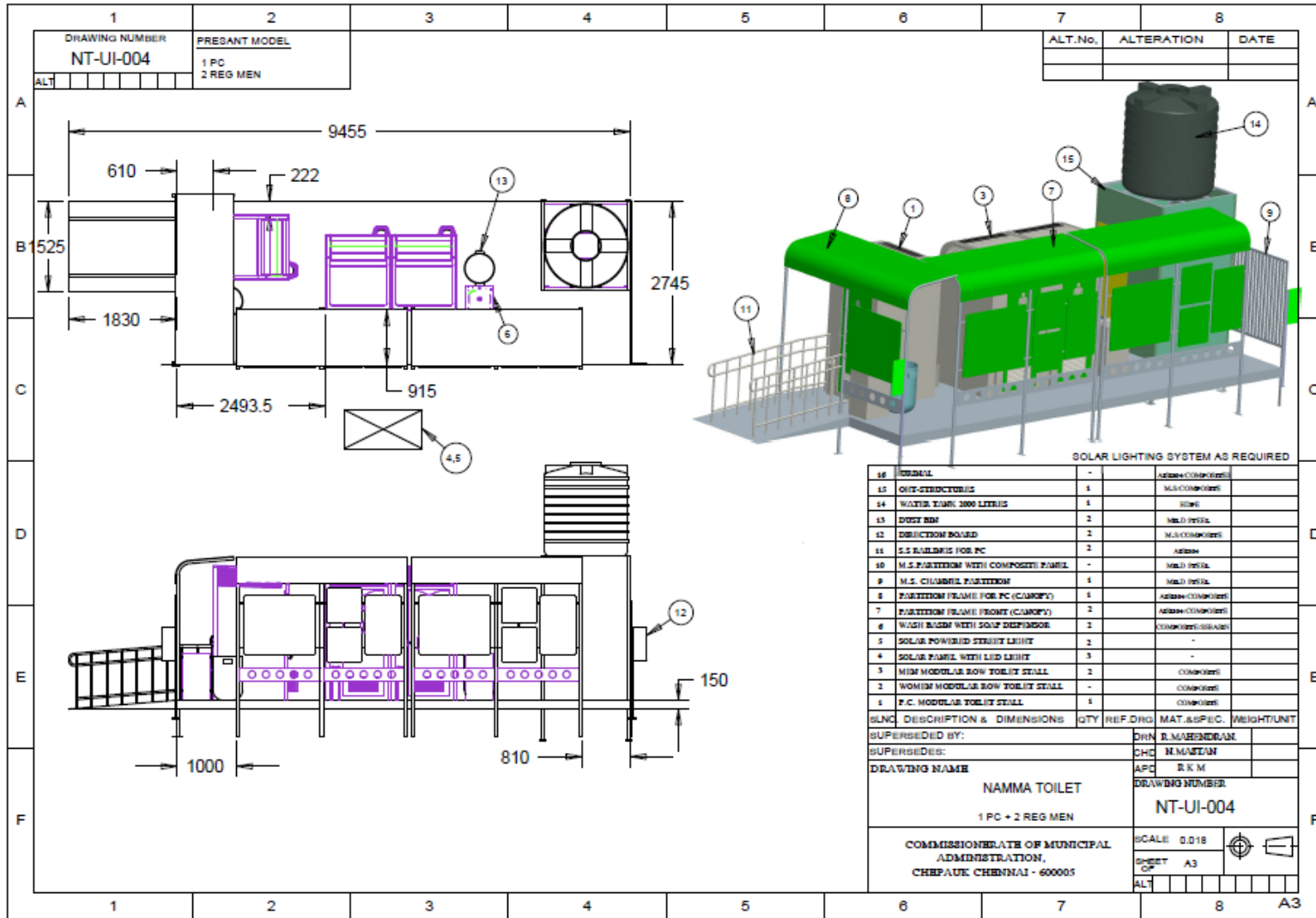

sustainable

toilet solutions

Configuration – 1PC + 2 Reg W

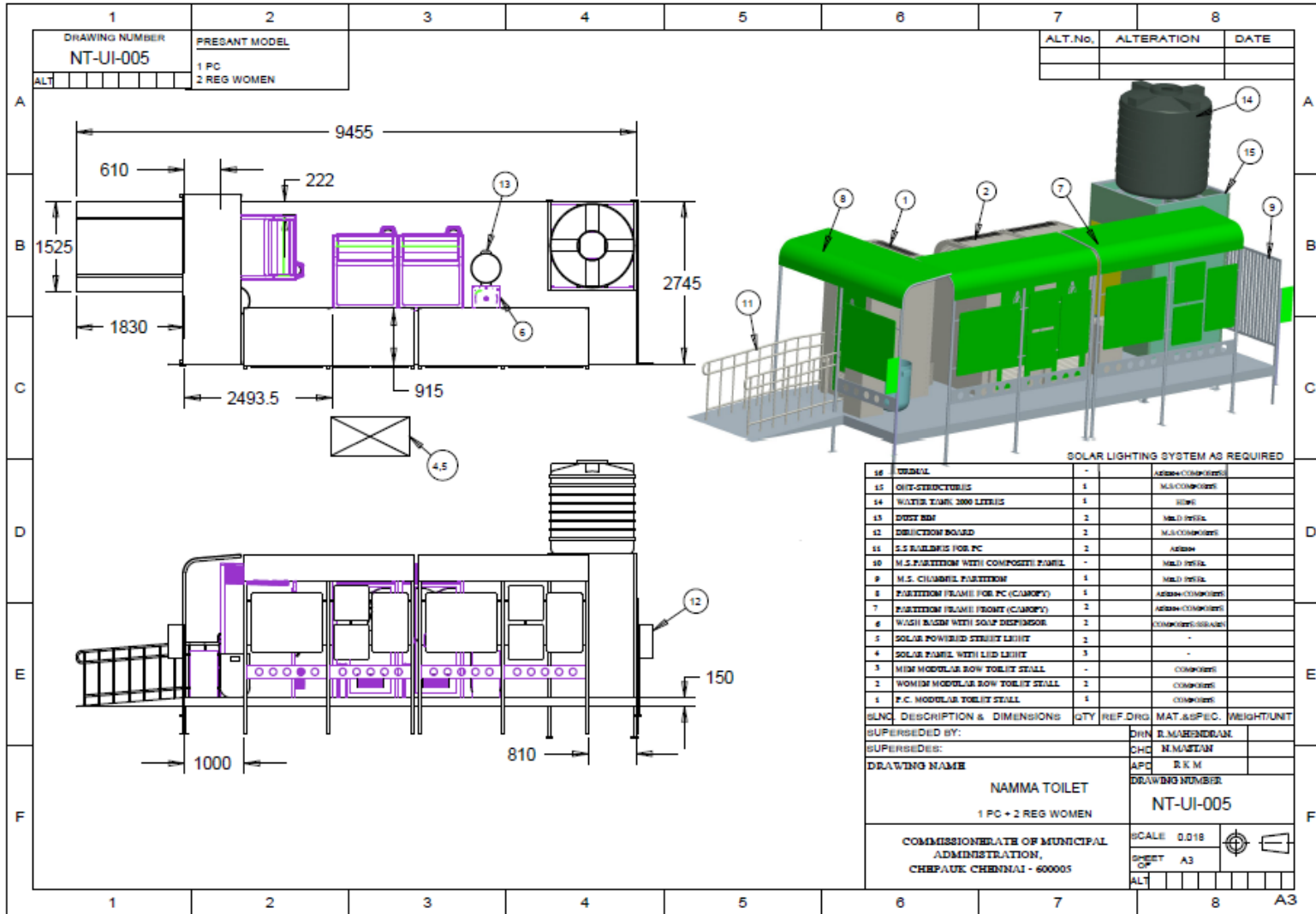

sustainable

toilet solutions

Configuration – 1PC + 3 Req M

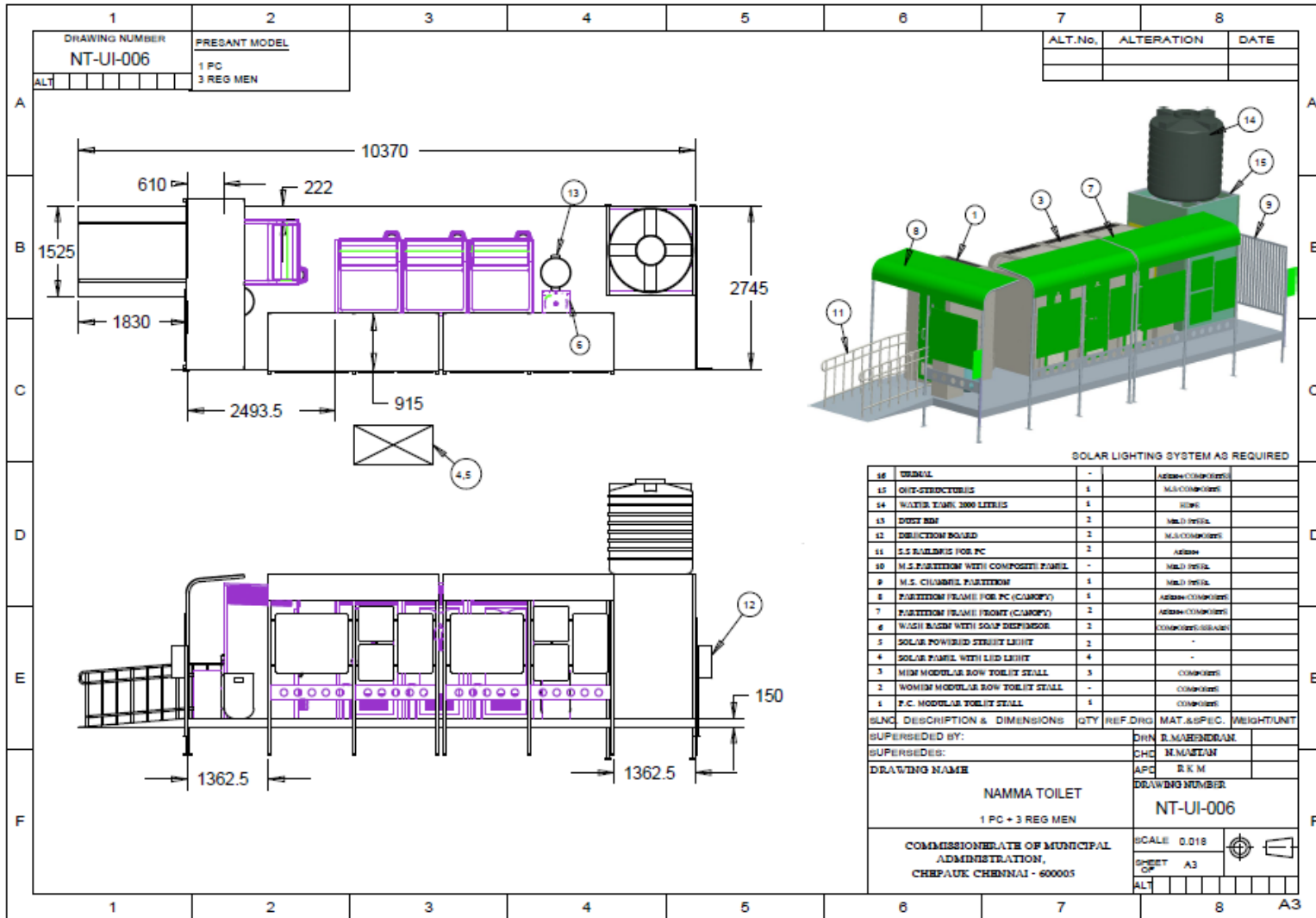

sustainable

toilet solutions

Configuration – 1PC + 3 Req W

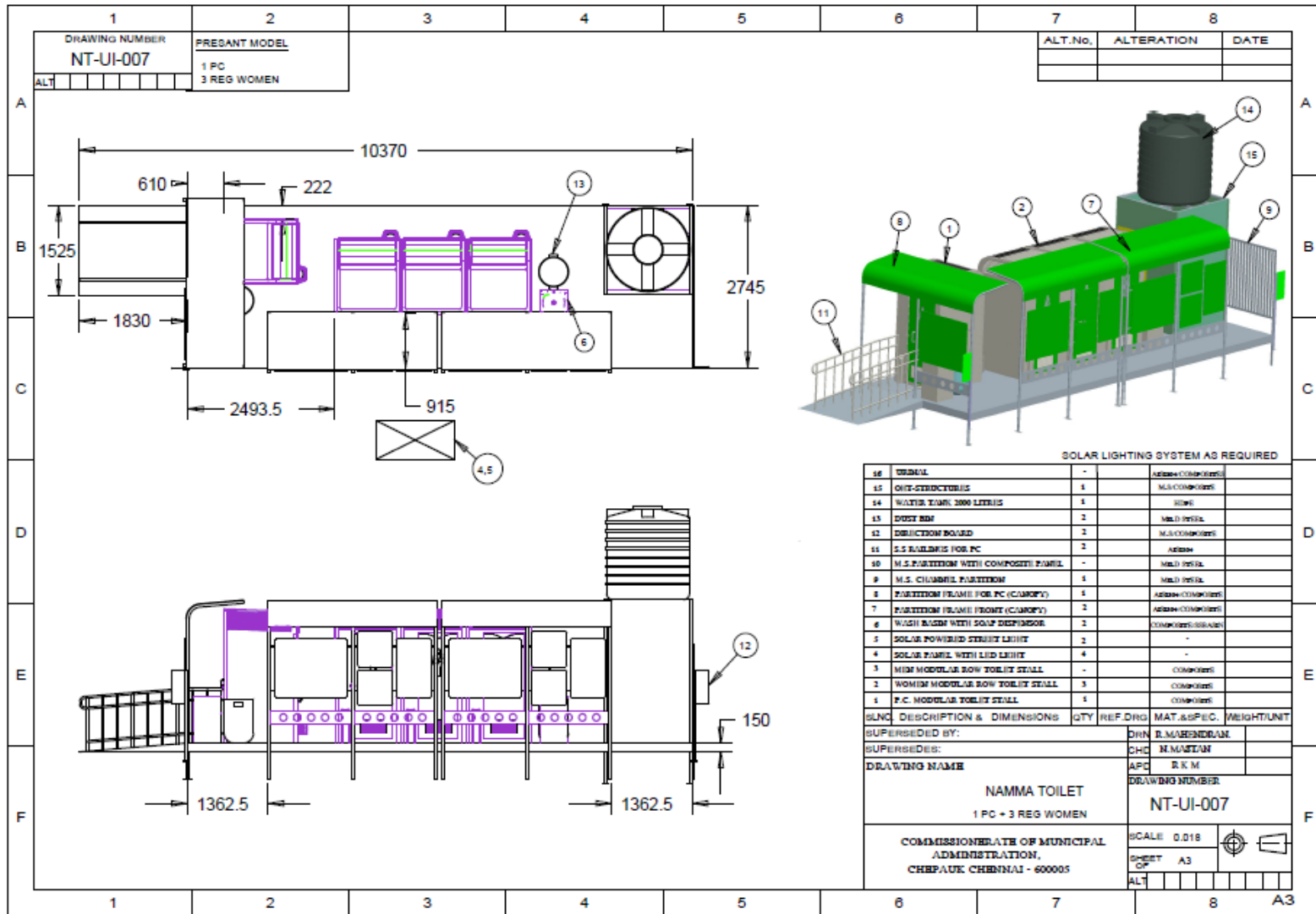

Configuration – 1PC + 4 Req M

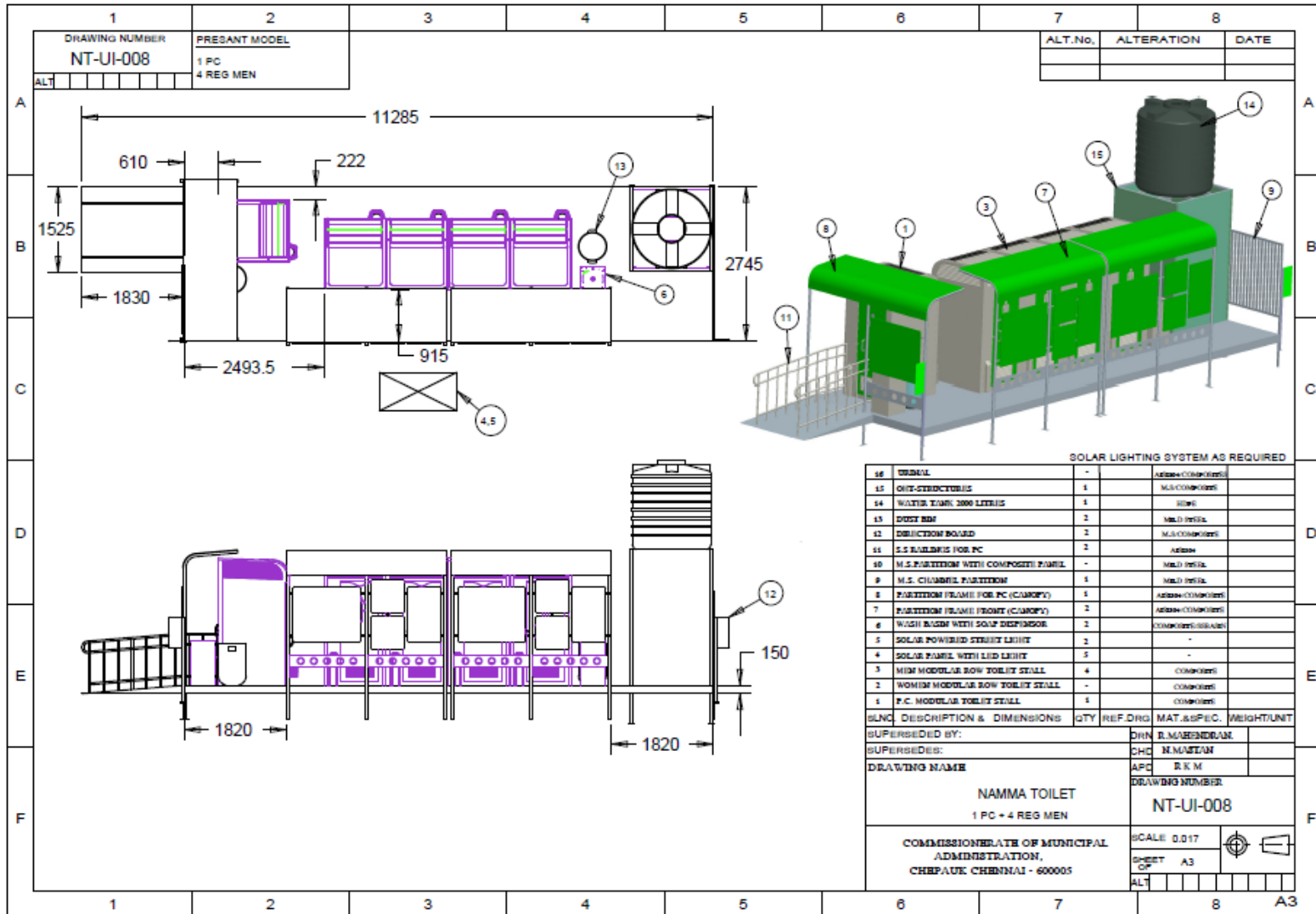

sustainable

toilet solutions

Configuration – 1PC + 4 Req W

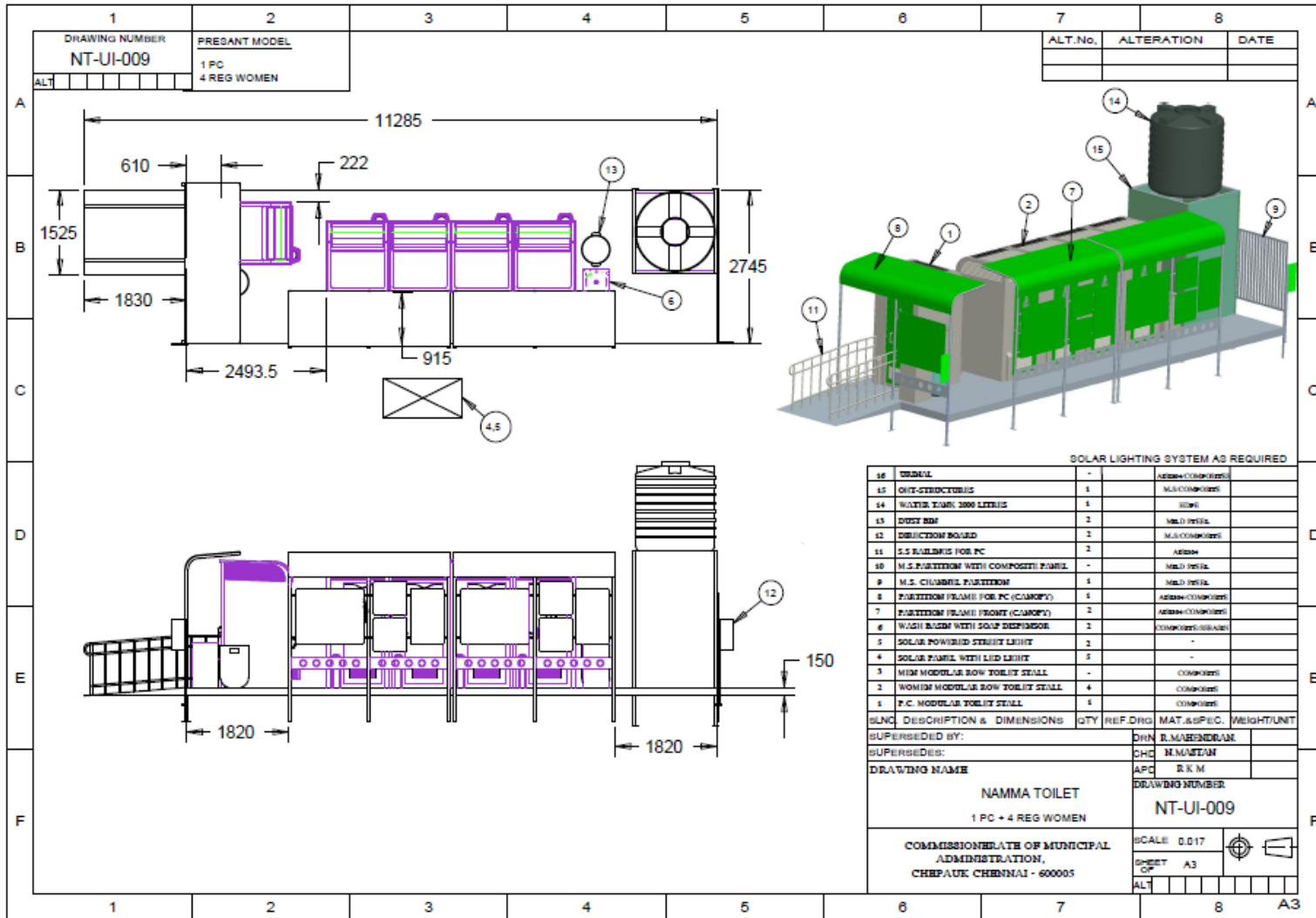

sustainable

toilet solutions

Configuration – 1PC + 5 Req M

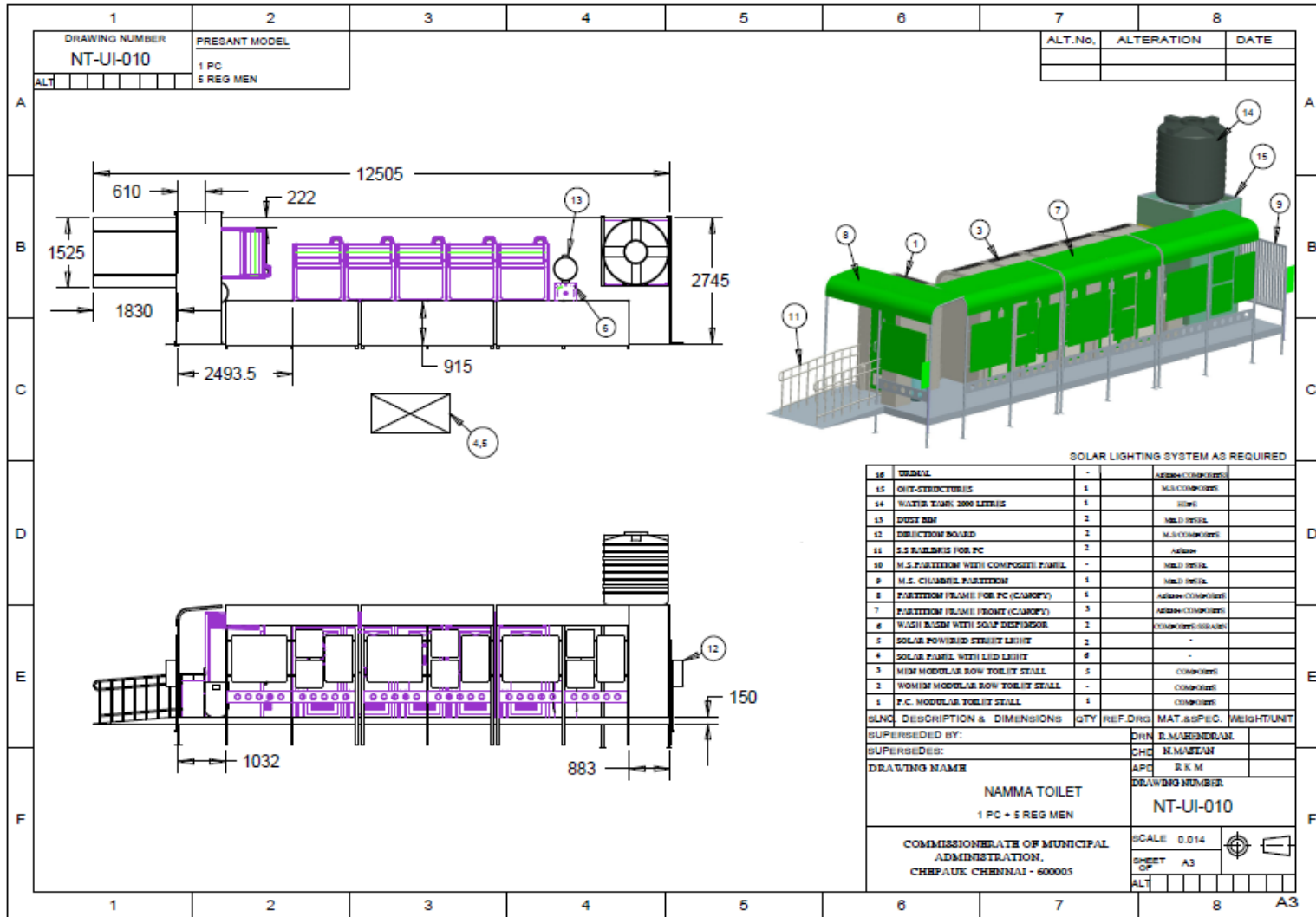

sustainable

toilet solutions



Configuration – 1PC + 5 Req W

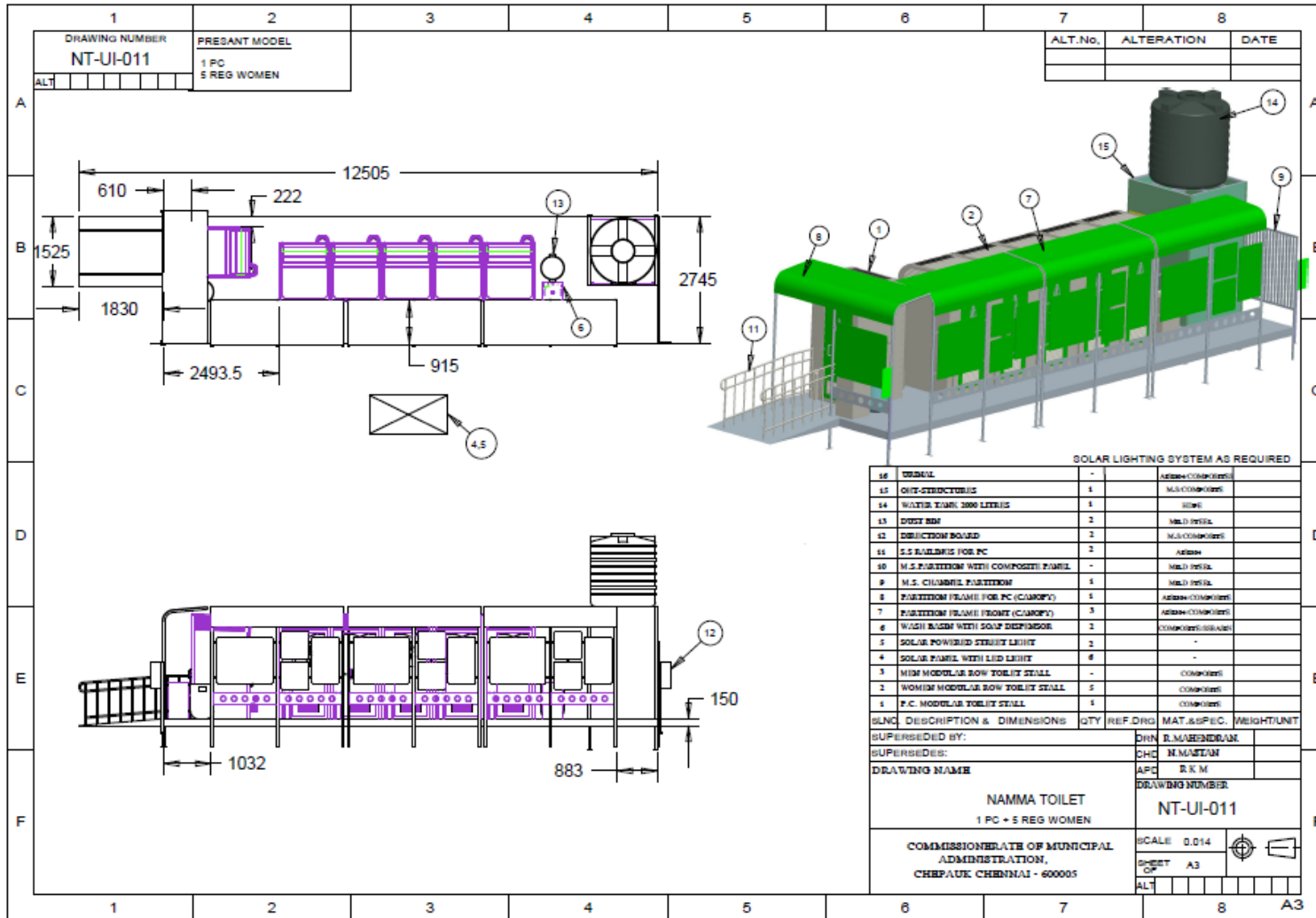

sustainable

toilet solutions

Configuration – 1PC + 2Req M + 2 Req W

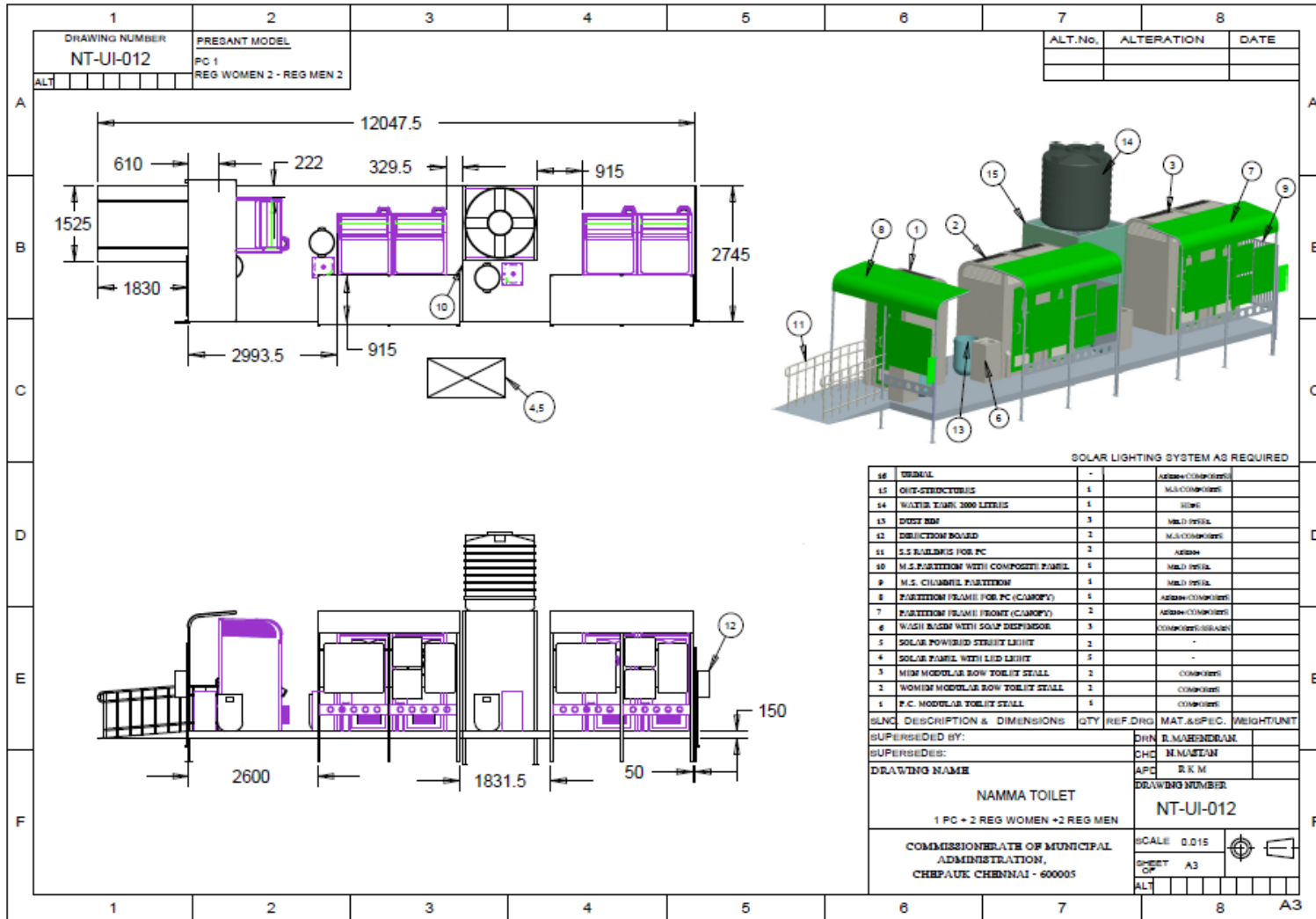

sustainable
toilet solutions

Configuration – 1PC + 3 Req W + 2 Req M

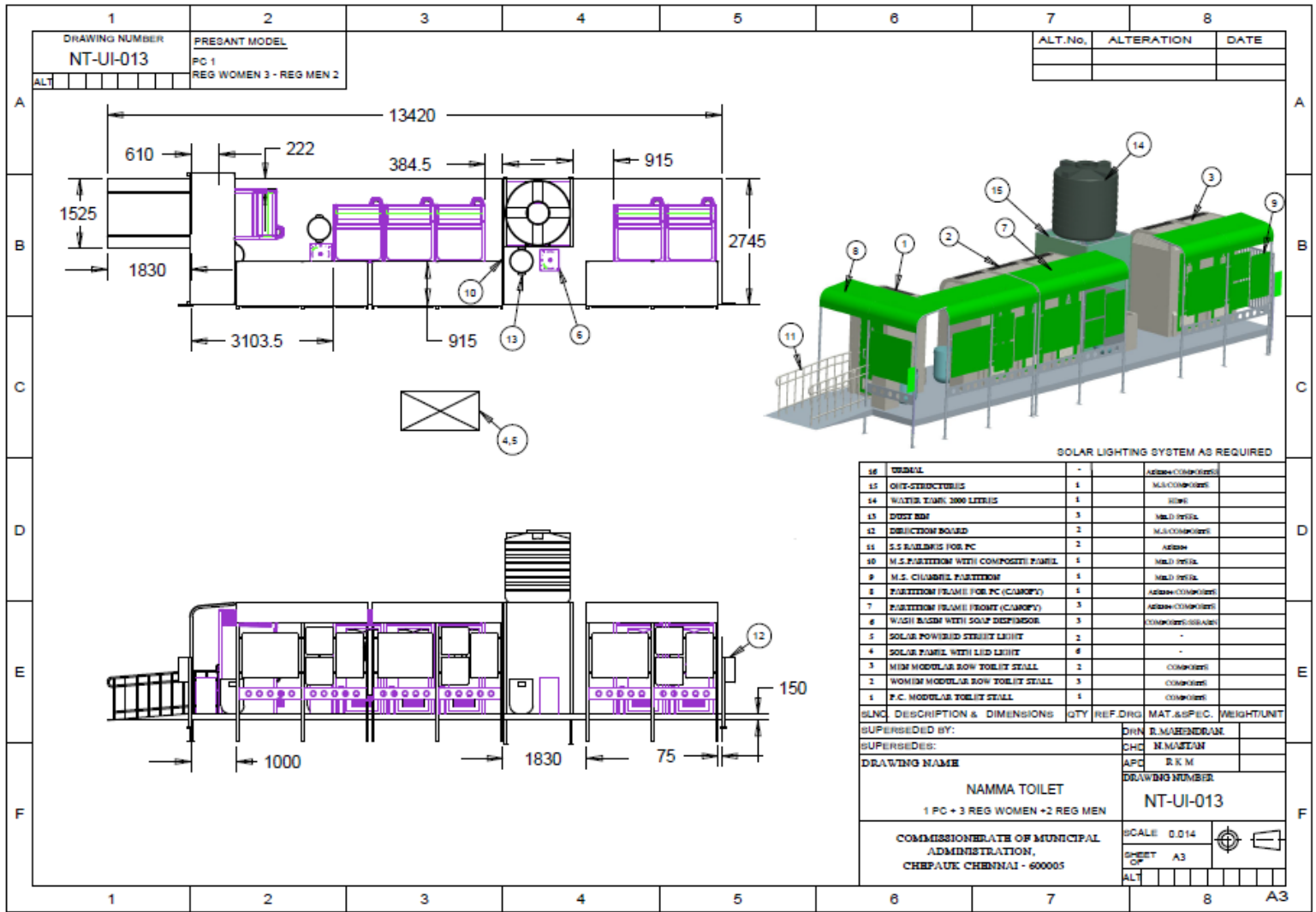

sustainable

toilet solutions



Configuration – 1PC + 4 Reg M + 2 Bath

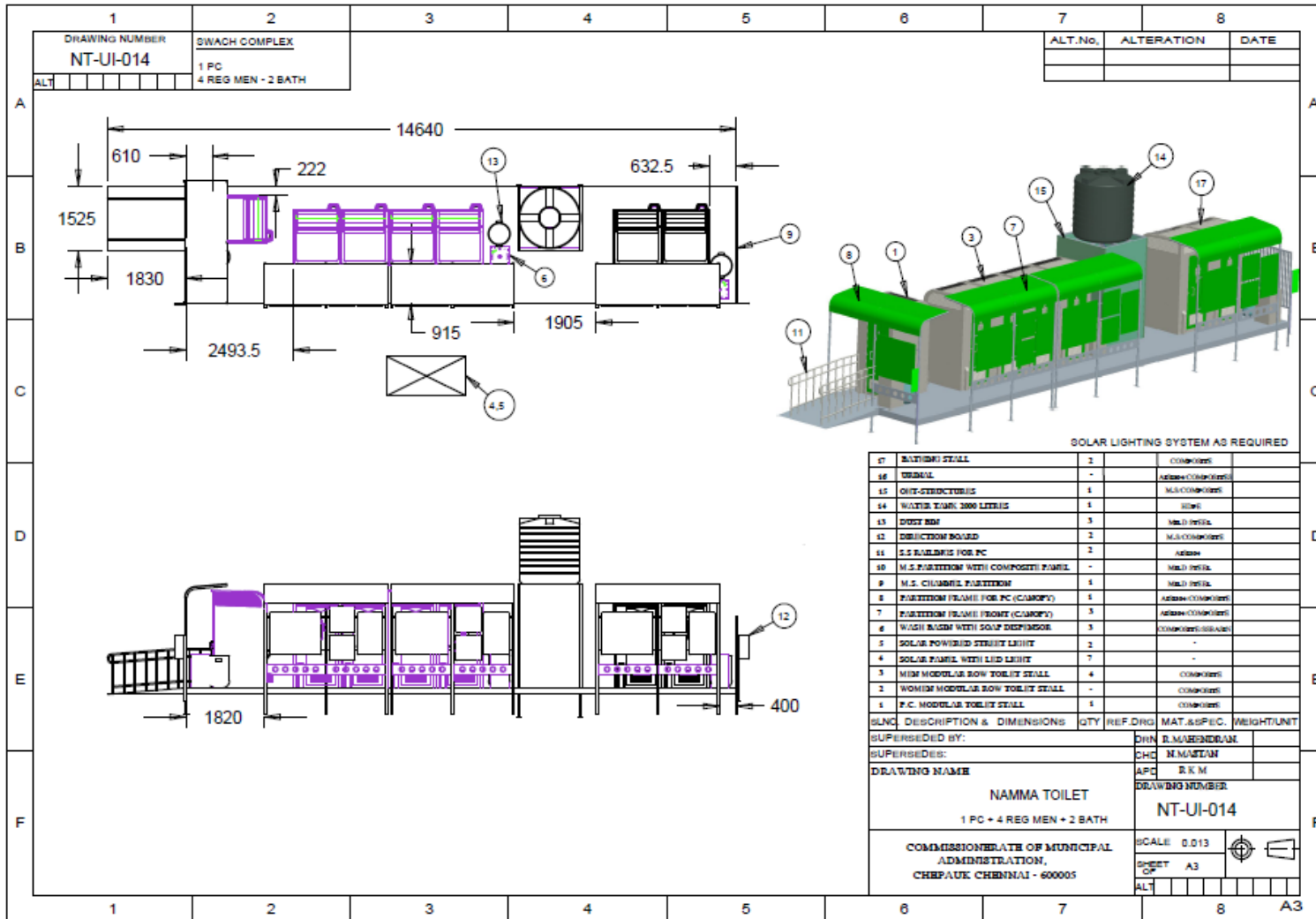

sustainable
toilet solutions

Configuration – 1PC + 4 Req W + 2 Bath

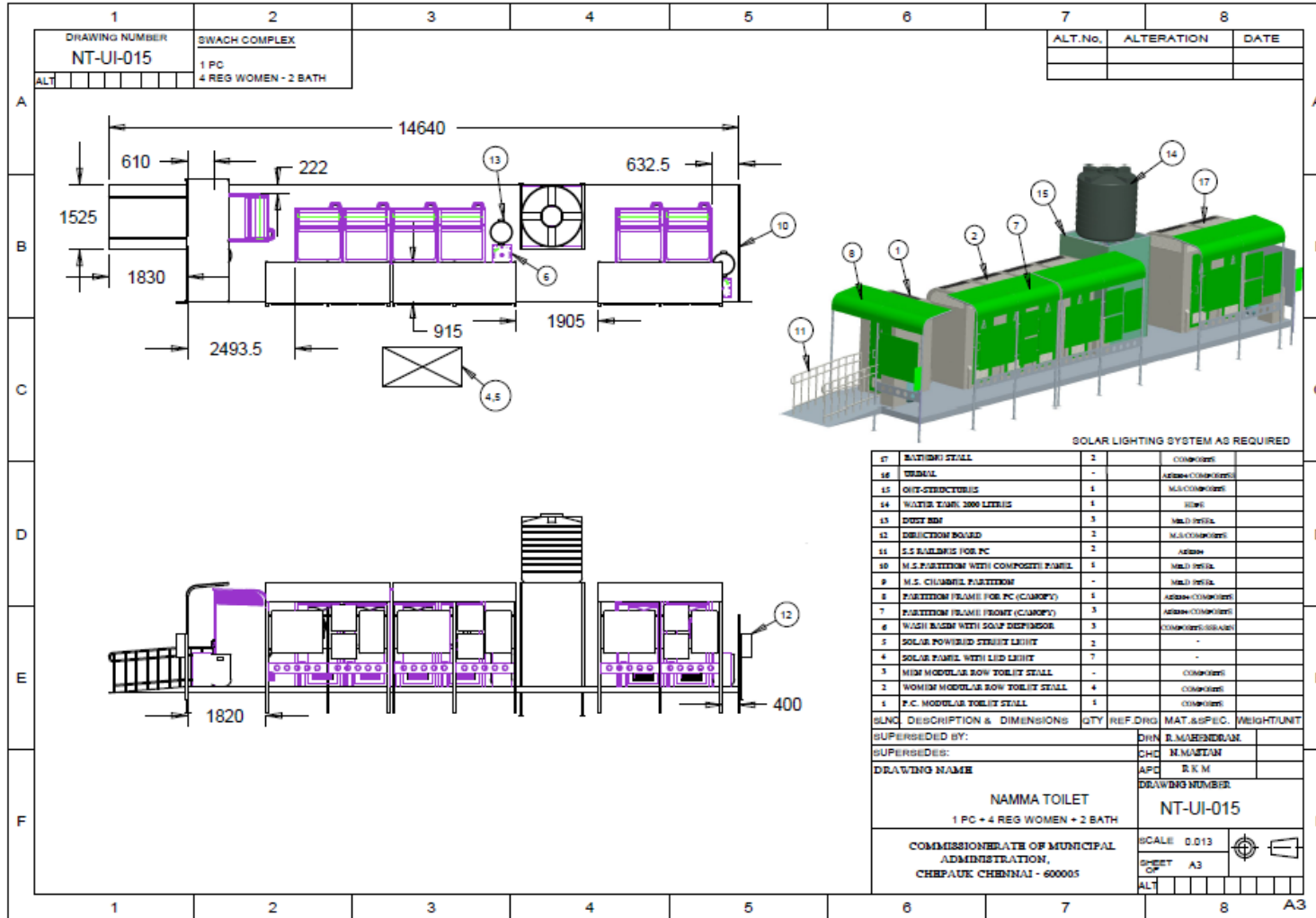

Configuration – 1PC + 8 Req M + 4 Bath

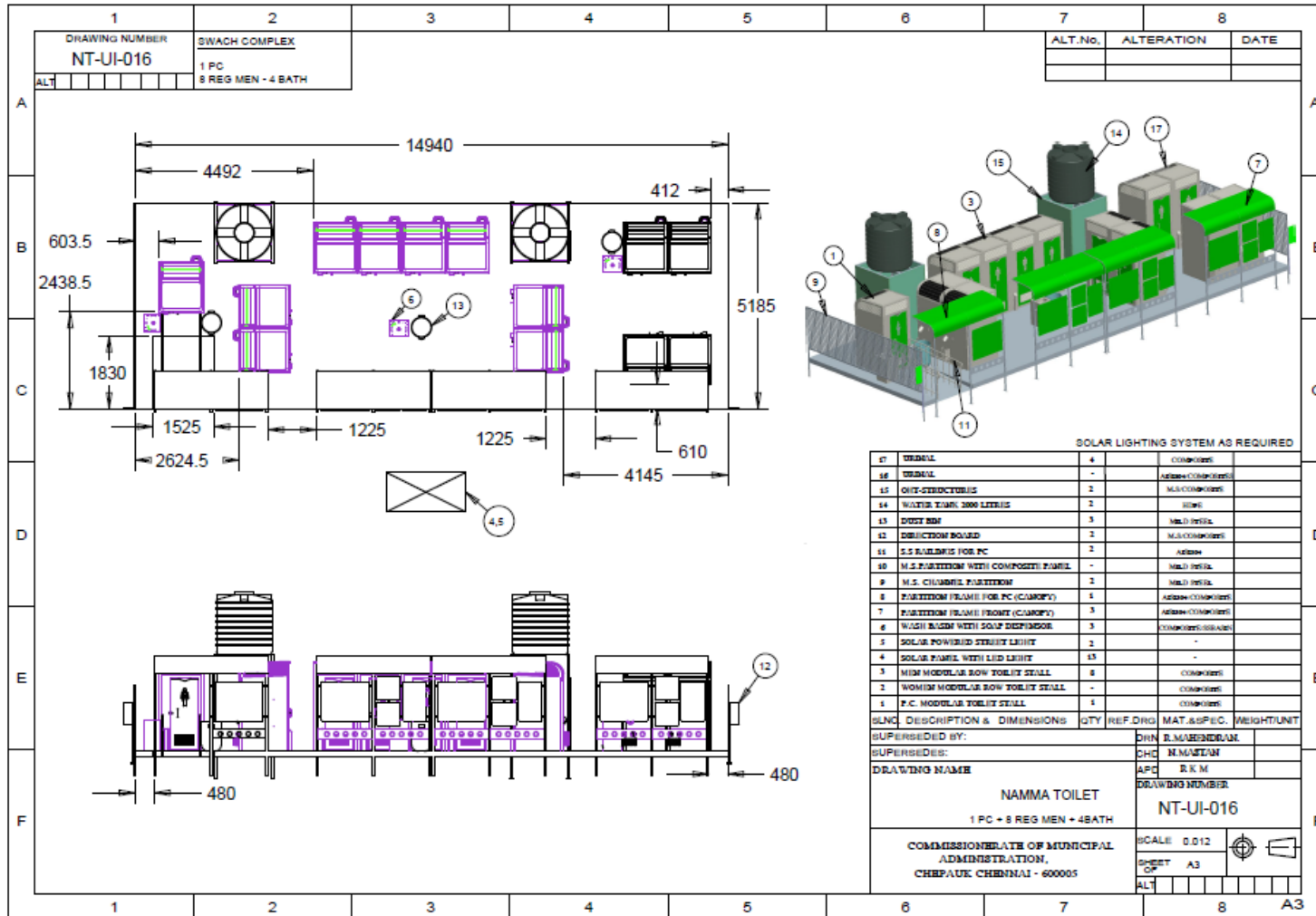

sustainable
toilet solutions

Configuration – 1PC + 8 Req W + 4 Bath

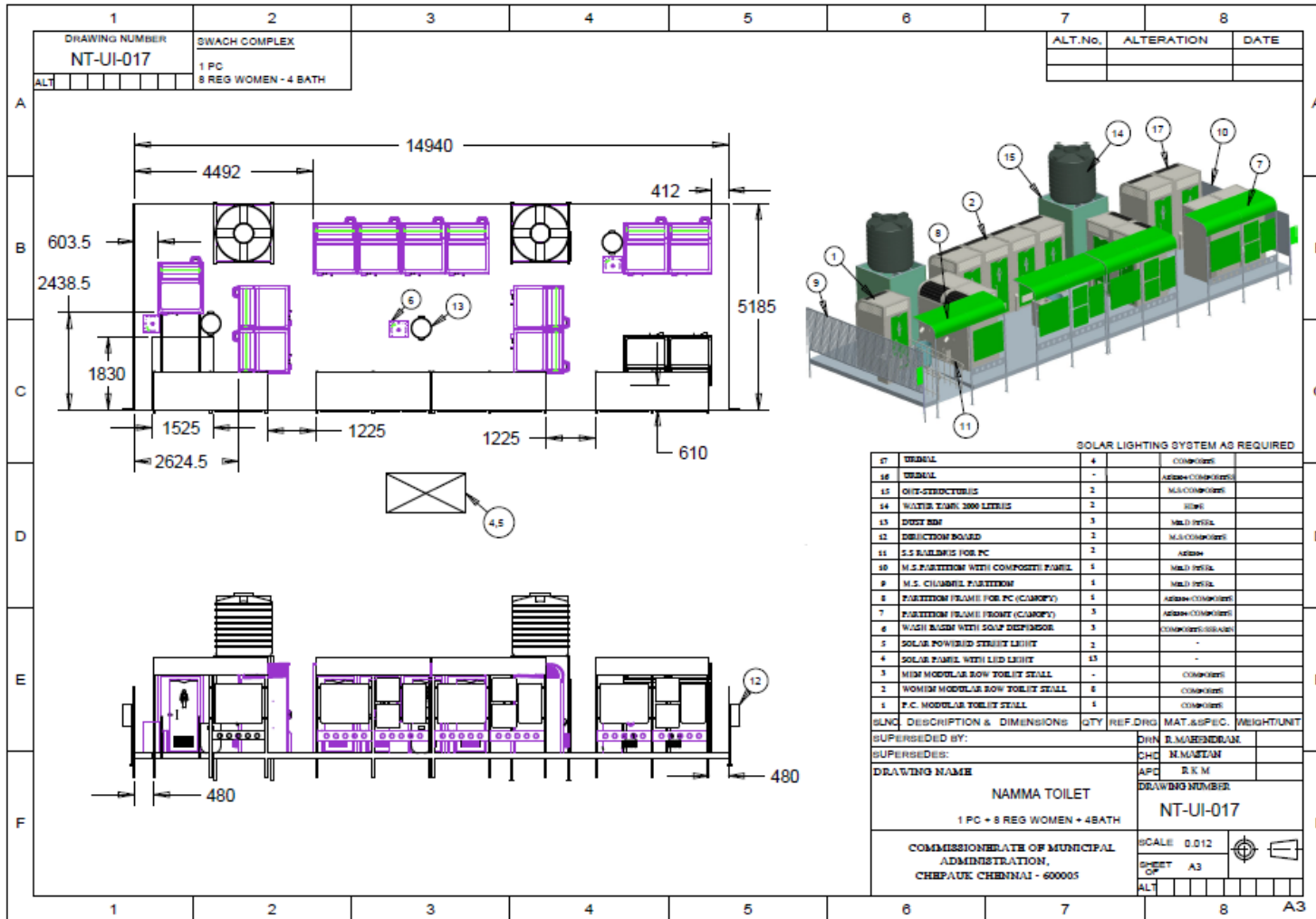

sustainable
toilet solutions

Contacts

Manufactured by

**Urbane Industries Limited,
48 SIDCO Industrial Estate,
Ambattur,
Chennai 600098**

For further information contact:

krish@urbaneindustries.com

Or

Krishnamohan +91 90030 96871 or 98400 91146



sustainable
toilet solutions

Happy Designing...

Thank you.....
