



BUS TERMINAL DESIGN GUIDELINES

This is a technical document produced by SGArchitects, New Delhi. This document is to be read in conjunction with Interim Report drafted by same in March, 2015. The author(s) of the book has taken all reasonable care to ensure that the contents of the document do not violate any existing copyright or other intellectual property rights of any person in any manner whatsoever. In the event the authors have been unable to track any source and if any copyright has been inadvertently infringed, please notify us in writing for corrective action. You may also contact us for any further technical clarifications and discrepancies, at the address below.

SGArchitects
6151/8, Sector D, Pocket 6
Vasant Kunj
New Delhi-110 070
www.sgarchitect.in

Key Contributors:

Sandeep Gandhi
Principal Architect

Satyajit Ganguly
Senior Transport Planner

Ruchi Varma
Architect and Urban Designer

Shruti Khandelwal
Architect and Urban Designer

Rajat Kalsi
Senior Architect

Nilesh Bansal
Architect

Acknowledgements

The authors would like to express our gratitude to Shakti Sustainable Energy Foundation.

Shakti Sustainable Energy Foundation works to strengthen the energy security of India by aiding the design and implementation of policies that support sustainable mobility, energy efficiency and renewable energy. The foundation not only funded the development of these guidelines but also provided feedback and continuous support in coordinating with various Government and Non-Government stakeholders.

We would also like to thank the different State Transport Undertakings (STU's) and Municipal Corporations, for their participation as case study examples, for their immense support and cooperation in making this document possible. We deeply acknowledge Coimbatore City Municipal Corporation(CCMC), Tamil Nadu State Transport Corporation(TNSTC), Delhi Transport Corporation (DTC), Kalyan - Dombivali Municipal corporation(KDMC) and Chandigarh transport Undertaking (CTU) for their guidance and valuable inputs.

Finally, we would like to thank the Association of State Road Transport Undertakings (ASTRU) for extending their support and guidance throughout the project. Their inputs have helped us immensely at various stages of development of this document.

Disclaimer:

The views/analysis expressed in this report/document do not necessarily reflect the views of Shakti Sustainable Energy Foundation. The Foundation also does not guarantee the accuracy of any data included in this publication nor does it accept any responsibility for the consequences of its use.

For Private Circulation

The information contained in this document is for guidance purpose and for reference only. The information is up to date, correct, and to best of our knowledge. You must not rely on the information in the report as an alternative to any legal and technical advice from an appropriately qualified professional. SGArchitects make no representations or warranties, undertake or guarantee that the use of guidance in the report will lead to any particular outcome or result. Any reliance you place on such information is therefore strictly at your own risk. SGArchitects will not be liable to you in respect of any business losses, including without limitation loss of or damage to profits, income, revenue, use, production, anticipated savings, business, contracts, commercial opportunities or goodwill, etc.

Contents

1	Introduction	1	5.3	Land Acquisition and Sourcing.....	84
1.1	Upgrading bus terminal infrastructure	2	5.4	Financial Requirement.....	85
1.2	Current state	2	6	Case Studies	95
1.3	Need for a Guideline	3	6.1.	City Bus Terminal	96
1.4	Target Audience	3	6.2.	Inter State & Local Bus Terminal	98
1.5	Terminal as public space: New approach....	4	6.3.	City Bus Terminal	102
2	Getting Started: Pre Planning	5	6.4.	Inter State Bus Terminal	104
2.1	Principles of Terminal Planning & Design	6		Annexure 1 - Planning Information and Considerations	108
2.2	Essential Requirements.....	7		Annexure 2 - Glossary of Terms.....	111
2.2.1	Primary Infrastructural Requirements .7			Annexure 3 - Specific Design Considerations for Bus Terminals	114
2.2.2	Supporting Infrastructure	8		Annexure 4 - Spatial Requirement Charts for Bus Terminals	116
2.3	Project Development	10	7	References	212
2.3.1	Project Initiation	10			
2.3.2	Site Identification & Project Planning. ..	10			
2.3.3	Institutional frame work.....	11			
2.4	Design Brief Development	12			
2.4.1	Terminal Characteristics.....	12			
2.4.2	Functional Attributes	13			
3	Planning.....	17			
3.1	Planning Assumptions	19			
3.2	Planning Information and Considerations .	22			
3.3	Functional Arrangement	25			
3.4	Functional Requirements.....	29			
3.5	Spatial Requirements.....	42			
3.5.1	How to use spatial requirements charts? .	44			
4	Designing.....	47			
4.1	Geometric Design Standards.....	49			
4.2	Intelligent Transport Systems (ITS)	57			
4.3	Services	60			
4.3.1	Lighting.....	60			
4.3.2	Drainage	61			
4.3.3	Fire Fighting.....	62			
4.4	Typical Details	64			
5	Financing	77			
5.1	Funding and Financing Models	78			
5.2	Cost and Revenue Generation	83			

List of Figures

Figure 1: Overcrowded bus in Delhi (www.tribuneindia.com).....	2	Figure 27: Proposed bus bays and Pedestrian infrastructure.....	96
Figure 2: Dilapidated Bus Terminal, Gurgaon (hotgurgoan.com)	3	Figure 28: Terminal Building Ground floor	96
Figure 3: Maribor Bus terminal (smartcitymaribor.si) 4		Figure 29: Terminal building First floor	96
Figure 4: Port Authority Bus Terminal New Jersey (inhabitat.com)	4	Figure 30: Bus circulation (for option 1).....	97
Figure 5: Design for differently-abled at a Bus terminal (skyscrapercity.com).....	7	Figure 31: Bus circulation (for option 2).....	97
Figure 6: Feeder bays The Vytilla bus terminal-cum-mobility hub Kerela. Photo: Vipin Chandran	8	Figure 32: Private vehicle and Feeder circulation	97
Figure 7: Denver Bus Terminal (longmontian.blogspot.com)	8	Figure 33: Pedestrian circulation in bus terminal.....	97
Figure 8: Sunderland Bus Terminal (scofield.com)	9	Figure 34: Proposed site for Bus terminal	98
Figure 9: Port Authority Bus Terminal. (Flickr/Harald) 9		Figure 35: Area allocation for ISBT and Local terminal (Proposal 1).....	98
Figure 10: The entrance to Union Station's newly redesigned-bus terminal, including an information booth (front right), a convenience store (back right) and a sheltered waiting area (center, behind the escalator). (Courtesy USRC, ©Anice Hoachlander)	9	Figure 36: Terminal Building Ground floor (Proposal 1)	98
Figure 11: Slough Bus Station (Photos: Hufton and Crow).....	10	Figure 37: Terminal Building First floor (Proposal 1) .	98
Figure 12: Project development stages	10	Figure 38: ISBT Bus circulation (Proposal 1)	99
Figure 13: A schematic representation of the functional attributes in bus terminal.	15	Figure 39: Local Bus circulation (Proposal 1).....	99
Figure 14: Design brief form	16	Figure 40: Private vehicle and Freight service vehicle circulation (Proposal 1).....	99
Figure 15: Decision making flow chart.....	18	Figure 41: Feeder circulation (Proposal 1).....	99
Figure 16: Methodology for using functional arrangement diagrams.....	25	Figure 42: Pedestrian circulation (Proposal 1).....	100
Figure 17: Methodology for using functional requirement sheets.....	29	Figure 43: Area allocation for ISBT and Local terminal (Proposal 2).....	100
Figure 18: Methodology for using spatial requirement graphs (example graph – site area against bus flow per hour).....	42	Figure 44: Terminal Building Ground floor (Proposal 2)	100
Figure 19: Scenario Description	43	Figure 45: Terminal Building First floor (Proposal 2)	100
Figure 20: ITS architecture for Bus Terminals.....	58	Figure 46: Pedestrian infrastructure to access the terminal	100
Figure 21: Budgetary Allocations flowchart for Bus terminals	78	Figure 47: ISBT Bus circulation (Proposal 2)	101
Figure 22: Various Revenue model contracts with their responsibilities, risk, and ownership and time durations (Source: Presentation by V. Srinivas Chary on Public Private Partnership in Urban structure and service delivery)	81	Figure 48: Local Bus circulation (Proposal 2).....	101
Figure 23: Diagram shows the typical structure of a SPV (Source: Investopedia)	81	Figure 49: Private vehicle circulation (Proposal 2) ..	101
Figure 24: Private sector participation spectrum (Source: ppp.worldbank.org)	82	Figure 50: Feeder circulation (Proposal 2).....	101
Figure 25: Typical BOT structure (Source: Wikipedia)83		Figure 51: Pedestrian circulation (Proposal 2).....	101
Figure 26: Proposed site for Bus terminal	96	Figure 52: Proposed site for Bus terminal	102
		Figure 53: Existing terminal circulation	102
		Figure 54: Area allocation & Bus circulation in terminal (Proposal 1).....	102
		Figure 55: Proposed commercial area (Proposal 1) 102	
		Figure 56: Dedicated Loading Bays for Buses (Proposal 1).....	103
		Figure 57: Area allocation & Bus circulation in terminal (Proposal 2).....	103
		Figure 58: Proposed commercial area (Proposal 2) 103	
		Figure 59: Aerial view of Proposal 2: Dynamic Operations in Terminal.....	103
		Figure 60: Fixed bus bays (Proposal 2)	103
		Figure 61: Bus terminal Site context.....	104
		Figure 62: Components of existing terminal	104
		Figure 63: Circulation in existing terminal.....	104
		Figure 64: Existing floor plan	104

Figure 65: Proposed depot, Local terminal area and Private parking area (same for both proposals)105

Figure 66: ISBT bus circulation for proposal 1105

Figure 67: ISBT bus circulation with Fixed bus bays (Proposal 1)105

Figure 68: ISBT bus circulation for proposal 2105

Figure 69: ISBT bus circulation with Dynamic bus bays (Proposal 2)106

Figure 70: Proposed Local bus terminal.....106

Figure 71: Proposed floor plans of Terminal building (for both proposals)106

Figure 72: Loading bus bays for ISBT buses106

List of Tables

Table 1: Critical terminal characteristics.....12

Table 2: Application of lighting in a bus terminal60

Table 3: Required lux levels according to the functions in a bus terminal (Source: Labour and Welfare Bureau of the Government of the Hong Kong Special Administrative Region).....61

Foreword

India's economic development and prosperity calls for increasing mobility of people to access various activities and goods. A major share of the mobility surge is being catered to by road based transport, of which a substantial component is met by buses. It is estimated that there are close to seven lakh buses operating in the country. Of these, approximately 150000 are operated by the public sector through more than sixty State Transport Undertakings (STU) and Transport Corporations. It is estimated that these buses carry more than 70 million passenger trips every day, which is nearly three times the passengers carried by Indian railways. Public sector buses alone are estimated to undertake 12.1 billion kilometers every year.

While buses form the structural core of the road transport, in the past few years, there has not been visible growth in their modal share in the total trips made, owing to the lack of adequate bus fleets and their supporting infrastructure like terminals and depots. Bus terminals, are the hub of activities, of passenger and operators, and are spaces where bus operators, STU and passenger requirements converge. Buses in India operate from nearly 3,000 terminals. There is a strong need to upgrade the infrastructure and facilities of these spaces into hubs which meet the requirements of both customers and bus operators.

Bus passenger terminals handle large volumes of passenger transfers on a daily basis. It can be said that passenger level of service at these locations goes a long way in ensuring attractiveness and increased patronage of bus transport. However, most bus terminals currently offer sub-optimal services to both bus passengers and bus operators. Most STUs struggle with constrained finances and therefore were unable to invest in the up gradation and regular upkeep of these facilities.

Though up gradation and development of bus terminals is high on the agenda of the STUs, there is a general capacity void which needs to be addressed. There exists no specific planning or design guideline on this subject, while there is an evident lack of knowledge and experience on successful PPP strategies. In this context this comprehensive planning and design guideline for bus terminal development is a first of its kind. It provides recommendations for various typologies and sizes towards the improvement the quality of public bus terminal infrastructure in Indian cities.

The guideline has been supported by Shakti Sustainable Energy Foundation with technical support provided by SGArchitects. I trust that this guideline will serve as an important resource in filling up the capacity gap for developing stakeholder requirement responsive bus terminals in India. It will contribute in making bus transport more attractive and will help in achieving our long term vision for a more sustainable mobility in the country.

Executive Director

Association of State Road Transport Undertakings (ASRTU)



P.S. Ananda Rao

Preface

The transportation sector, covering both passenger and freight services, is the second largest consumer of primary energy in India after the industrial sector. It currently contributes to 18-20% of the national primary energy demand. Population and economic growth are leading to an increase in the mobility needs for goods and passengers that are rising at an annual rate of 9%. The passenger transport sector is becoming highly energy intensive because of a shift in consumer preference from public transport to private transport. This has severe implications for climate change and air quality in the country. There is an urgent need to arrest this shift and undertake necessary measures that can increase the use of public transport for urban mobility and inter-city travel.

Reliable, safe and comfortable public transport systems are a precondition for developing sustainable transport systems. Bus systems, in particular, are extremely relevant since they form the majority of public transport trips. Improved bus services and developing state-of-the-art supporting infrastructure like bus terminals, depots and bus stops can attract users and increase ridership.

I am pleased to announce that Shakti Sustainable Energy Foundation has signed a Memorandum of Understanding with the Association of State Road Transport Undertakings (ASRTU) towards a consultative and engagement framework for the planning, design and implementation of improved bus systems. The current document is an important component of the initiatives under the MoU. It aims to provide technical support to State Road Transport Undertakings (STUs) to develop better bus terminals in the country.

The 'Bus Terminal Design Guidelines' developed by S G Architects with support from Shakti, provides guidelines for design and planning of bus terminals of different capacity and functions. These guidelines have been developed after a detailed review of national and international best practices. The readiness of the guidelines was verified by developing the designs of four bus terminals. I trust that these guidelines will be of interest to the State Road Transport Undertakings, architects, planners and designers and its recommendations will be translated into action.



Krishan Dhawan
Chief Executive Officer
Shakti Sustainable Energy Foundation



1 Introduction

Public transport holds center stage in the urban transport agenda. A well-functioning and sustainable city cannot be achieved without strengthening its public transport system. Infrastructure plays a vital role in the operation of an efficient, convenient and safe transit system (Trans Link Transit Authority 2011). When transit infrastructure is designed to enhance passenger experience, its attractiveness is ensured, making it a viable alternative to private motorized transport. The National Urban Transport Policy (NUTP) (MoUD 2006) recognizes that city dwellers are of utmost importance and that all plans must be centered on their common benefit. With reference to a focus on public transportation, the NUTP document emphasizes the following means:

1. Encouraging greater use of public transport and non-motorized modes by offering Central financial assistance for this purpose
2. Enabling the establishment of quality focused multi-modal public transport systems that are well integrated, and provide seamless travel across modes
3. Establishing effective regulatory and enforcement mechanisms that allow a level playing field for all operators of transport services, and enhanced safety for the transport system users
4. Building capacity (institutional and manpower) to plan for sustainable urban transport, and establishing knowledge management system that would service the needs of all urban transport professionals, such as planners, researchers, teachers, students etc.

The NUTP envisages a scenario wherein all city residents have access to jobs, education, recreation, and other such needs within urban limits, in a safe, affordable, quick, comfortable, reliable and sustainable environment. At present, lack of robust public transport infrastructure renders Indian cities struggling to cope with increasing mobility requirements. Numerous research and studies have documented the ill-effects of a poor or dysfunctional public transport system and associated infrastructure. Characteristic among these ill-effects are - higher dependence on private motorized modes, and higher congestion, pollution and accidents. These effects—which ultimately reduce quality of life—are attributed to the lack of mobility options.

1.1 Upgrading bus terminal infrastructure

Buses are the predominant mode of motorized public transport in India. All Bus systems combined carry much more passengers than any other mass transit systems. A functional bus system is an essential element of both intercity and Intracity public transport system. Bus stops, bus terminals and depots are the critical infrastructure components of a bus-based transit system. Bus terminals are the nodal points at the beginning and end of journey.



Figure 1: Overcrowded bus in Delhi (www.tribuneindia.com)

A bus terminal is the point at the start/end of a bus route, where the vehicles stop, reverse and wait, before departing on the return journey. It also serves as a station for passengers to board and alight. Evidently, at a bus terminal, parameters addressing passenger and operator requirements overlap. It is the site for interchange between large volume of bus and passenger traffic. This demands that the facilities at a bus terminal be planned systematically and that user requirements be addressed in such planning, or else the lack of an efficient and functional environment will lead to friction, ultimately compromising the attractiveness of the bus system.

1.2 Current state

A review of bus terminal projects from around the world suggests that the best practices in terminal planning and design are people centric. Such designing—of bus terminal infrastructure, its operation and maintenance plan—is guided by the vision of securing a high level of quality and comfort both for passengers as well as terminal and bus staff. If Indian cities are to follow such a passenger service quality focused approach towards bus terminal planning—in terms of infrastructure, operations, and financial planning—certain enablers must be put in place.



Figure 2: Dilapidated Bus Terminal, Gurgaon (hotgurgoan.com)

1.3 Need for a Guideline

A review of the current situation suggests that the lack of capacity and resource material (such as guidelines and tools specific to Indian context) may be one of the reasons for unsatisfactory bus terminal infrastructure in Indian cities. A detailed planning and design guideline for bus terminals can not only propel capacity building, but further drive the development of more responsive passenger-specific bus infrastructure. The need to bridge the resource gap is the main motive behind this guideline.

This guideline is developed to meet the need for resource material specific to Indian context; it will provide planning and design recommendations for different typologies and sizes of bus terminal complex. The following points further explain the objectives of the guideline, and its intended role towards improving the quality of public bus terminal infrastructure in Indian cities:

1. Ensuring synchronized and functional interaction between passengers, buses/operators as well as feeder modes such as intermediate public transport (IPT)
2. Providing efficient access and egress to and from the terminal, for both passengers and buses
3. Ensuring planned and streamlined traffic circulation, and provision of amenities for passengers, rest areas, and other facilities for bus drivers, as well as workshop and workshop space for operators.

1.4 Target Audience

This guideline has been developed for three types of target audience:

1. Planners and designers
2. Project proponents
3. Project developers

It is aimed at assisting planners and designers in understanding the requirements of different terminal typologies and scales. This will help guide the planning and design process of future projects towards the aim of ensuring that such projects are responsive to the requirements of different users of the facility. This guideline will equip planners and designers with tools to finalize functional and spatial requirements. It will provide design standards, among other suggestions.

Project proponents can use this guideline to vet the development proposals (by planners, designers or developers). It includes easy-to-use tables and charts, which allow a clear picture of different facilities and their space requirements to be included in a proposal.

This guideline includes space and site area requirements for projects of varying sizes and typologies, based on inclusion or exclusion of different real estate development linked infrastructure requirements. These are tied to expected project cost, and the real estate floor area required to be developed in order to offset the same.

1.5 Terminal as public space: New approach



Figure 3: Maribor Bus terminal (smartcitymaribor.si)



Figure 4: Port Authority Bus Terminal New Jersey (inhabitat.com)

The main characteristic of bus terminals is their convergence function, because they serve as important nodes of transfer between different modes. These nodes are the focus of passenger activity, which is a potential ingredient for a vibrant city space. Needless to say, high level of passenger activity attracts business and retail functions, which generates secondary footfall and propels a mere terminal site into an attractive urban destination.

Thus, Indian cities require a new approach of planning and designing terminals, one that views them as integrated in the urban realm and contributing to the quality of the city space. Within this framework, not only shall designers and planners secure the prerequisites of a transport infrastructure facility, but also explore its integration in the urban fabric as a tool to catalyse its surroundings. Terminal branding can also prove to be a crucial element, one that contributes towards image building of the overall public bus system besides, adding to the passenger experience.

Embracing a modern approach to bus terminal infrastructure development, this guideline is aimed to equip users with practical knowledge, the know-how critical

for developing a user friendly facility which meets the requirements of all stakeholders, and contributes to the overall quality of a city. This information is divided into three sections. The section 'Getting Started – Pre-planning' addresses pre-planning issues such as planning principles, planning requirements, design brief development etc. 'Planning and Design' presents planning and design information, including functional requirements, spatial requirements, and design requirements. 'Financing' deals with different financing options, as well as contractual requirements for the project.



2 Getting Started: Pre Planning

The pre-planning stage for bus terminal development includes steps necessary for undertaking detailed infrastructure planning. These steps include understanding the principles of bus terminal planning, developing an understanding of key project ingredients, initiating project development requirements (such as site identification), and developing a detailed project brief.

2.1 Principles of Terminal Planning & Design

Principles governing how to approach the planning of bus terminals are focused towards ensuring enhanced passenger experience and level of service. These have been listed below, and may be applied during the design development process.

Access and approach: Traditional bus terminal facilities fail to provide convenient access to public buses; their closed confines make access extremely difficult for passengers. Current attempts to improve bus-based public transport access are only concerned with improvement of street infrastructure, and focused mainly on pedestrian facilities and bus stops.

Access to the terminal should be convenient, barrier free and facilitate streamlined internal circulation. Additionally, the ingress and egress points should be so located that they are not in conflict with traffic circulation at the peripheral road network (Planning Department Hong Kong 2014). One way of achieving this is by creating alternative access/egress points by integrating multi modal facilities with the bus terminal; this can further convenience commuters by providing access/egress choices.

Location: Locational characteristics make for the key factor attracting passengers using the bus terminal (Trans Link Transit Authority 2011). Centrally located (core city areas) bus terminals are desirable for operational efficiency and passenger convenience, as they provide ample interchange opportunities. Additionally, they are potential candidates for using terminals as a vibrant city space. Peripheral terminals, when integrated with depot functions, work best in minimizing dead mileage.

Operational parameters: Planning and designing of bus terminals is significantly influenced by the termi-

nal's operational attributes. Several operational parameters bear upon a bus terminal's requirements. These include the number of routes served and their peak frequency, volume of waiting passengers, spaces for bus stacking (idle parking), the mix of terminating and passing services, and passenger circulation (Trans Link Transit Authority 2011). Thus, it is essential to the terminal planning and development process that the operational parameters are fully understood and accounted for.

Existing capacity and future demand estimation: In addition to operational requirements, terminal planning and designing should also factor in the estimates for existing capacity and future (horizon year) demand. The considerations for redressal of potential short-term and long-term capacity constraints, and future expansion on the basis of estimated horizon year demand should be incorporated early in the planning stage (Trans Link Transit Authority 2011).

Enhanced level of service: The basic premise of the Level of Service (LOS) framework is that passengers are sensitive to the amount of space surrounding them. When this space is compromised by crowding, they perceive it as a deterioration of service (Transportation Research Board 2011). LOS is an indicator of how good the present situation in a given facility is, and helps determine the environmental quality of a given space based on the function it is serving. To plan for critical LOS requirements for a terminal (as listed in different standards), one must first understand the entire journey of a passenger through the facility. Each activity planned for the passenger/commuter needs to offer a baseline level of service as per space standards and area allocation.

Integrating multi-modal accessibility and feeder infrastructure: Integrating provisions for feeder modes—like cycle rickshaws, auto rickshaws, buses, private vehicles etc.—in the facility design, ensures improved accessibility and conflict free circulation. Planned allocation of space for such modes helps reduce delays, and improves level of service for passengers. The aim is to facilitate seamless transfers, in order to create the impression that the journey is continuous (and without breaks).

Crime prevention through environmental design (CPTED): Passenger safety is fundamental to the attractiveness and increased use of public transport. A commuter should feel safe using public transport at any time (of day and night) and at any location (Trans Link Transit Authority 2011). CPTED promotes the notion that it is possible to apply creative urban design principles to reduce incidence and perception of crime. This includes better urban planning, including effective lighting, barrier-free circulation, enhanced visibility, signage and way finding, integrated commercial activities (formal or informal) to avoid dark or inactive corners etc. Integrating CPTED shall ensure better connectivity as well as enhanced and attractive usage.

Integrating universal design: India's Disability Act of 1995 suggests that public infrastructure be barrier-free for all. This implies that bus terminal facilities should be inclusive and accessible for all, including differently-abled people, people carrying luggage, pregnant women, children, people travelling with infants (in hand or stroller) etc. All passengers should be able to cover their journey in a seamless manner with minimum effort.



Figure 5: Design for differently-abled at a Bus terminal (skyscrapercity.com)

Integrating sustainable development practices: Infrastructure plans and development practices should consider green building technologies to reduce the overall carbon footprint and adverse impact on the environment, both during the development and operational phase. Construction practices may employ material (and techniques) with low embodied energy, while energy requirements for the terminal's operations may be met through sustainable means and use of efficient technologies. This may include use of solar

energy, efficient LED lighting, passive cooling/heating measures, higher reliance on natural lighting etc. Additionally, techniques for noise control, solid waste management, waste water re-cycling, use/re-use of waste water, and rain water harvesting should be integrated in the proposal during the planning stage.

2.2 Essential Requirements

The guideline intends to provide standards and recommendations for planning and designing bus terminals, per the Indian context. For this, a list of broad infrastructural requirements has been drawn up, through literature review. These requirements are the essential ingredients for planning and designing bus terminals, and have been classified as primary infrastructure requirements and supporting infrastructure requirements.

2.2.1 Primary Infrastructural Requirements

The infrastructural requirements for bus terminals respond to the bus and passenger demand within a given site. Identified infrastructural elements consume space based on planned capacity, which when aggregated defines the site area requirement for a proposed terminal facility. These infrastructural elements include bus transfer, park-and-ride, drop-off, vehicular parking, and meet-and-greet areas, as well as the various inside-terminal elements such as walkways, stairways, escalators, elevators, turnstiles, ticket machines, and platforms. They vary with the requirements of passengers, staff and drivers.

Ancillary facilities that act as feeder to bus terminal, also need attention. The building area that houses these facilities needs to respond to a defined level of service in order to accommodate the required footfall. Space and architectural standards define the relationship between spatial requirements and level of service. Suggestions and recommendations for use of material (and finishes) appropriate and conducive for a public zone are also included in the guideline.

Primary elements to be considered with regard a bus terminal's infrastructure development can be classified for three different user types. These include passengers, terminal staff and bus staff.

1. Passenger areas

- a. Ticketing and queuing
- b. Passenger waiting areas

- c. Passenger conveniences (drinking water facilities and toilets)
- d. Passenger circulation
- e. Boarding/Departing areas
- f. Facility entry
- g. Tourist information
- h. Security, including CCTV cameras
- i. Retail, concessions and lease space
- j. Dormitories and lodging (if required)
- k. Cloak room
- l. Railway reservation

2.Areas for terminal staff

- a. Revenue office
- b. Security and information
- c. Ticketing booth
- d. Resting room
- e. Staff conveniences (drinking water facilities and toilets)
- f. Canteen
- g. Maintenance staff (chairs and lockers)
- h. Control room (CCTV surveillance)

3. Areas for bus staff

- a. Canteen
- b. Resting areas
- c. Lodging areas (if required)
- d. Bus staff conveniences (drinking water facilities and toilets)

2.2.2 Supporting Infrastructure

Bus terminal infrastructure planning is not just about provision of requisite facilities, but also about how these facilities serve the terminal users. It has been observed that even large and newly constructed terminals fail to meet commuter requirements and expectations. This can be attributed to poor functionality and upkeep of provided facilities, such as shabby waiting areas, lack of connectivity, dilapidated rest sheds, stinking environs, poor ambience etc.

Supporting infrastructure refer to the additional facilities which aid in enhancing user experience, efficiency, and attractiveness of bus terminal. These include provision for feeder infrastructure, seating, landscaping, lighting, way finding (Passenger Information Systems (PIS), signage and marking), public art, and breakdown services.

Feeder infrastructure: The infrastructure which connects the bus terminal with the city is referred to as

supporting access (or feeder) infrastructure. It includes provision for various modes that provide access—and act as feeder—to the bus terminal. These include parking for private vehicles; drop-off and pick-up bays for private vehicles, taxis, auto rickshaws cycle rickshaw, shared vehicles such as vans/jeeps etc.; and bays and/or stops for local bus services. Integration of all these modes makes for higher passenger convenience and increased intermodal accessibility.



Figure 6: Feeder bays The Vytila bus terminal-cum-mobility hub Kerala. Photo: Vipin Chandran

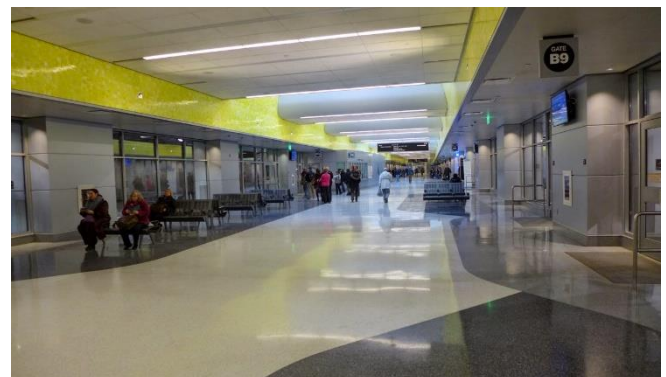

Figure 7: Denver Bus Terminal (longmontian.blogspot.com)

Seating: Seating—in and around the bus terminal complex—shall be planned to cater to a minimum of 30% of all passengers in the facility. Seating is required so as to avoid obstruction to the flow of passenger traffic through the complex; it should be designed to combine comfort, ease of maintenance and resistance to vandalism.

Hardscape and landscaping: It is important to ensure that landscaping complements the spatial design and enhances the visual appeal of the terminal. Outdoor and indoor passenger areas should be smoothly hardscaped, to facilitate easy connection between site’s periphery and the terminal. The paving’s surface quality should ensure durability as well as resistance against wear, walking comfort and usability by wheel-chairs, prams and baggage trolleys.

Lighting: Lighting should be designed to meet minimum illumination levels and quality standards for both indoor and outdoor application. Natural lighting elements such as sky lights shall be used to enhance lighting level without increasing the energy load of the terminal facility. Lighting fixtures should be energy efficient, require low maintenance, and minimize light pollution and glare.



Figure 8: Sunderland Bus Terminal (scofield.com)

Signage: PIS—including both dynamic and fixed signage—constitute an integral part of the terminal’s way finding infrastructure, and play an important role in regulating vehicular and pedestrian movement. They provide relevant information, warnings and directions, thus facilitating ease of access, convenience and safety. They should be strategically placed, consistent and easy to interpret. Public address system should be integrated into the design, at all terminal facilities. The aim is to provide a robust, functional, and visually discrete system that can provide communicative information and also be linked to the security system for warning (in case of emergency).



Figure 9: Port Authority Bus Terminal. (Flickr/Harald)



Figure 10: The entrance to Union Station's newly redesigned-bus terminal, including an information booth (front right), a convenience store (back right) and a sheltered waiting area (center, behind the escalator). (Courtesy USRC, ©Anice Hoachlander)

Public art: Visual space perception (mental copying of objects and events of the outer world) helps people recognize spaces within a particular environment, such as a bus terminal complex. It increases the imageability, cultural identity, and social attractiveness of enclosed spaces. As such, public art installations and other aesthetic elements in the complex are likely to contribute to its visual appeal and overall attractiveness, and must be integrated into the terminal building’s development. Contemporarily, ‘public art’ has also come to include various other elements like urban furniture, lighting, multimedia, graffiti and commercial art. Public art is by the people, and for the people, and as such should also be sourced from them. Therefore, it is important to allocate planned spaces for such installations, and make appropriate funding available for integration of the same.



Figure 11: Slough Bus Station (Photos: Hufton and Crow)

In-terminal breakdown services: Buses plying on long inter-state or intra-city routes often require minor maintenance, involving fan, engine belt, tires, outer body etc. As terminals are not equipped to handle minor breakdown requirements, buses remain parked there, till engineers from the concerned depot can visit to attend to them, or they can be towed back. This affects the service schedule, in turn inconveniencing the passengers. Therefore, including provisions for in-terminal breakdown service in infrastructure, is crucial for an efficient service planning.

2.3 Project Development

The bus terminal development process—culminating at an operational terminal—includes three broad stages, i.e. project initiation, site identification cum project planning, and institutional framework setup. These stages are introduced in Figure 12, and elaborated in the following sections.

2.3.1 Project Initiation

Project initiation ensures an action oriented approach to implementing bus terminal infrastructure. This stage includes gathering information required to begin the project, followed by organization and documentation of the data collated for developing it. Further, the project initiation stage involves all necessary analysis undertaken for planning the project, such as conceptualizing availability of sites (for the project), with de-

tailed information on operators, principal stakeholders, and authorities. Additional information required at this stage includes city demographics, existing transportation scenario, existing facility conditions etc.

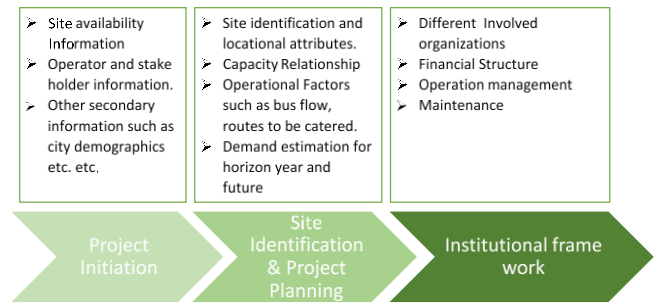

Figure 12: Project development stages

2.3.2 Site Identification & Project Planning.

This is the second stage of project development and comprises two phases; the first involves identifying a suitable site and the second, initiating the planning process specific to its context.

In the first phase, government officials and other stakeholders (such as the land owning agency, state transport undertaking (STU) etc.) identify a suitable site. Identifying an appropriate site is a critical component of project development. It must address two major considerations:

- **Location Attributes:** Currently, the selection of a site for a bus terminal is governed primarily by the availability of land. However, other location attributes—passenger demand and the bus route network—should also be considered. If the site is not near trip generators, it may make access harder for commuters. Additionally, if it is off the serving route network, dead mileage will up the vehicle operating costs (Rodrique, Comtois & Slack 2013). The terminal’s location also influences its revenue generation potential; easy accessibility will affect attractiveness for private investment, such as for commercial/real estate development.
- **Capacity relationship:** Land being finite puts a cap on the capacity of each site. Understanding the site’s capacity yields an insight into maximum volumes that it can cater to: peak passenger flow that can be handled, maximum number of buses that can be accommodated at idle/loading/unloading bays, and maximum number of cars that can be parked. There is a dynamic relationship between

the site area and the space to be reserved for commercial development: a larger facility requires higher investment (achieved through an integrated commercial/real estate development), which demands higher commercial/real estate development footprint (including space for private vehicle parking), to offset the increased funding requirement, which in turn leads to higher site area requirement. Understanding the area-capacity relationship helps the decision maker appreciate the relationship between available site size and achievable capacity. In an urban setting, bus terminals have a nominal capacity, which is related to the amount of land they occupy and the level of applied technological, labour and managerial capability. According to, *The Function of Transport Terminals* (Rodrique, Comtois & Slack 2013), a utilization rate of 75 to 80% is considered optimal (i.e. 75 to 80% of theoretical capacity can be used to cater to demand), because above this level, congestion starts to arise, undermining the reliability of the terminal facility. This information should be applied in bus terminal site selection.

Once the site is identified, project development enters the planning phase. Planning is guided by the selected site's features, which include its existing conditions (potential and constraints), operational factors (such as layover time) and most importantly, capacity requirements of the terminal (depending on the peak flow of buses and routes originating and terminating there). For a green field terminal site, capacity requirement for the terminal needs to be established based on horizon year demand estimates.

2.3.3 Institutional frame work

The third (and concluding) stage in project development consists in building a stable institutional framework for the project, the objective being establishing a set of formal organizational structure, rules and norms towards provision of the terminal facility. These relate to - how and who will operate the terminal, how the facility will be maintained, how revenue (for the facility's development and maintenance) will be generated/sought, and what (if any) the business model will be. The framework proposes multiple agencies and or-

ganizations (mentioned below) that may come together (in different formats) to develop, maintain and/or operate the facility.

1. Bus service providers: These include government departments and municipalities, public corporations, and private sector companies.
2. Regulatory and enforcement bodies (if separate from local authorities): These help regulate terminal operations as well as services, and establish necessary controls for terminal facility management.
3. The private sector: Its participation plays an important role in financing and maintaining the terminal facility. Both public and private sector participation can be financed by commercial banks and other financial institutions.
4. Local authorities: These act as regulators and service providers, help raise finance, and supervise the activities related to the development, maintenance, and/or operation of the terminals (covering the area within the terminals' boundary as well as those surrounding it).

In an ideal institutional framework, these agencies (and organizations) operate as per clearly defined roles and responsibilities, and a well-defined co-operative relationship, which is usually put down in a legally binding contract. In case of infrastructure projects especially for bus terminals, various management models are devised to ensure the provision of services and facilities, such that the provision is sustained beyond the implementation of the project. These management models involve the financial structure, operations management, and maintenance of the terminal.

Financial Structure: This is the framework adopted to acquire and support funding, which is a necessary step to enable the terminal's development, maintenance and operations. The financial structure helps formulate how to finance the project, including detailing debt and equity ratios etc. Embracing recent trends based on different and evolving revenue models, the financial frameworks for development of bus terminal projects have kept pace, changing from time to time. Chapter 5 – Financing discusses financial structuring of bus terminals in detail.

Operations management: This is an area of management concerned with planning, designing, and controlling the functions of a terminal, and if required, re-designing operations as per the desired level of services. Essentially, operations management optimizes the process of converting terminal inputs (current operations, size, and typology) into outputs (improved efficiency and better functionality). It entails ensuring that operations are resource-efficient, and effectively meet terminal requirements.

Maintenance: Bus terminal maintenance, though costly and time-consuming, is a critical indicator of a terminal’s attractiveness. Proper maintenance of bus facilities goes a long way in preserving the terminal system’s positive image. Ways to execute this include - creating a database of maintenance schedules (to track elements like condition of pavement surfaces; age of the facilities; history of damage; and condition of shelter, benches and other transit amenities), and forging working agreements with local businesses or commercial centers, to help share the terminal agency’s financial responsibilities.

2.4 Design Brief Development

Brief development is a critical starting point for the planning and design exercise of a bus terminal project. The brief provides an outline of the project’s objectives and their corresponding design strategies, thus yielding the design solutions. The brief development stage assists the planners/designers to list all functional and operational requirements, and any associated spatial and material ones.

First stage of the brief development exercise is to identify and classify the terminal’s critical functional and operational characteristics. These are terminal typology, terminal size, and classification by terminal operations. Table 1 presents these characteristics and their respective features.

Table 1: Critical terminal characteristics

S. No.	Characteristics	Description
1	Terminal Typology	Inter state or Local
2	Terminal size	Small, Medium or Large
3	Terminal Operations	Fix route Bay Allocation or Dynamic Bay Allocation

These terminal characteristics and their related functions form the structure of this guideline. Terminal characteristics and functional attributes are explained in sections 2.4.1 and 2.4.2.

2.4.1 Terminal Characteristics

Terminal Typology: The hierarchy of routes served is one of the primary determinants of a terminal’s design and planning. In India, there are mainly two different types of terminals:

- **Local Bus Terminal** – Bus services at a local bus terminal cater to routes whose starting and terminating points connect two different places in the same city. On these routes, buses stop to board and offload passengers at short intervals, usually about 0.5 km.
- **Interstate Bus Terminal (ISBT)** – Starting and terminating points connect two different states, regions/districts, or cities; long intervals between stops, usually greater than 10 kms

Terminal Size: This characteristic denotes the scale of a bus terminal, irrespective of its hierarchy (interstate or local). Terminals are categorized under three scales based on the bus flow per hour - Large (more than 300 buses per hour), Medium (more than 60 up to 300) and Small (less than or equal to 60).

Terminal Operations: This characteristic determines the operations type of a bus terminal, in terms of allocating boarding bays to different routes. The categorization is based on the current preference and norms followed by the terminal operator (usually state or city transport undertakings). In India, two operations types are observed:

- **Fixed Route Bay Allocation¹**- This operations type is usually observed in medium and large

¹ For details of bay arrangements Refer to the Interim Report – Section 2.4.2.1

bus terminals, and entails fixed (specific to a route) bay allocations i.e. a particular route will be allotted its specific bay or a boarding spot, and every bus plying on that route will always commence from there. More than one route may be assigned to the same bay.

- **Dynamic Bay Allocation**²- In this type of operations, buses dock at a vacant bay or one assigned by the terminal supervisor at entry. These are not fixed to a particular route. Such terminal operations are observed mainly at small terminals; they can work with large bus flows only in the presence of a good passenger information system (PIS).

2.4.2 Functional Attributes

Terminal operations involve a complex juggling of functions to support bus and passenger handling. These functions (discussed below) influence terminal infrastructure planning, maintenance and design.

1. **Bus bay allocation:** This relates to types of bay allocation for buses, depending on terminal operational characteristics such as layover time and bus flow. Buses use terminal space for offloading passengers, idle parking (based on the assigned layover time), and loading passengers. These three activities influence how bus bay planning is undertaken:
 - **Common bays** – As per this allocation type, buses park at a common bay, and load, unload and rest in idle state all at the same location. Common bays allow only for fixed route bay allocation for buses, and are planned mostly for local bus terminals with short layover time.
 - **Segregated Bays** – As per this allocation type, bays are segregated by activity, i.e. as loading bays, idle bays, and unloading bays. Buses move between these three locations/bay types sequentially. Such bay planning helps save space and works best with longer layover time; it is thus observed mainly at interstate bus terminals. Segregated bays can be planned for both fixed route and dynamic bay allocation.
2. **Bus boarding bay arrangement**³: This relates to types of boarding bay arrangements, and is

influenced by the bus demand, circulation pattern, curb length limitations, and space availability in the terminal. There are five types:

- **Saw tooth bays:** This arrangement works well with one-way driveway (along the bays), and allows easy pulling in and pulling out of buses, without the need to reverse. Additionally, it ensures reduced gap between bus and platform while docking.
 - **Angular bays (60, 45, 30 degrees):** These work well with one-way driveway and allow easy pulling in, but require reversing while pulling out. A reduced angle of bay minimizes driveway width requirement, but increases curb length requirement.
 - **Perpendicular bays:** This arrangement requires minimum combined area per bus (bay + driveway), but maximum driveway width, and higher effort (and time) for pulling in (and out). Perpendicular bays are thus most suitable for idle parking or for boarding bays in small terminals with a long layover time.
 - **Linear/parallel bays:** A long linear platform serves multiple buses. Linear bays usually include an overtaking lane which acts as a driveway. They work with one-way driveway, occupy long curb length per bus, but require minimal driveway width. Linear bays find it difficult to allow drivers to reduce gaps between bus and platform while docking.
 - **Drive through bays:** Drive through bays allow for parallel bays, each with a single drive-in lane. These bays may be arranged at 30, 45, 60 or 90 degrees to the curb. To get to drive through boarding bays, passengers need to cross multiple bus driveways. This is usually solved by providing raised cross-walks. Thus, drive through bays work well for low passenger volume terminals or those which require minimal baggage transfer; they suit local bus terminals more than inter-state ones.
3. **Average Layover Time:** This is the most important determinant of capacity requirement for a terminal's bus specific infrastructure (boarding, offloading and idle parking bays).

² For details of bay arrangements Refer to the Interim Report – Section 2.4.2.1

³ For details of bay arrangements Refer to the Interim Report – Section 2.5.1.1

Layover time is the time a bus spends inside the terminal, from entry to exit. Higher the layover time, higher the accumulation of buses inside the terminal, and higher the capacity requirement to accommodate them. Layover time is usually pre-defined by bus operators based on their operational and service requirements. However, planned and actual layover time have been observed to vary significantly. Therefore, it is important to capture both planned and observed layover time, before initiating the planning process. The latter is usually estimated at off peak time when the layover time is expected to be longer.

4. **Private Vehicle Parking⁴:** This relates to the type of parking arrangement for private vehicles at the bus terminal. It is influenced by the parking demand and space availability in the terminal, and is classified into four categories:
 - **Structured parking:** Parking on multiple floors (multilevel parking), usually above ground
 - **At grade parking:** Parking arranged only at ground level
 - **Shared parking:** Parking not exclusive to bus terminal private vehicles, such as public parking in a district catering to visitors to the area, including those accessing the bus terminal
 - **On street parking:** Parking arranged along the street, not planned on a land parcel set off the street, usually outside the terminal complex.
5. **Feeder service Integration:** This relates to the type of infrastructure provided for feeder service integration at the terminal, and is classified into three types:
 - **Intermodal:** Includes infrastructure integration with transit systems such as metro or public bus systems
 - **Feeder lanes:** These provide feeder services without parking provisions. They are used for pick and drop only, not waiting (by feeder modes such as auto rickshaw, taxi and cycle rickshaw). To enable waiting, separate holding space must be integrated for such feeder modes. This holding space feeds vehicles to the feeder lanes when required.
6. **Finance:** This relates to the broad financing strategy adopted for the terminal, and is classified into two types:
 - **Public ownership** - On failing to attract private participation (in terms of part or complete equity) due to locational attributes of site, political, bureaucratic limitations etc., the terminal development project is entirely publically financed.
 - **Public private Partnership (PPP)** – When public funds fail to meet the urban sector's investment requirements, a terminal development project must rely on the public private partnership method to raise additional finance as well as to improve delivery methods. Private equity can be raised through various methods, most common being exchange of land rights related to the terminal site. This exchange entails transferring a component of the site—or floor area ratio (FAR) at the site—to the private partner, for real estate development and allied functions such as parking.
7. **Bus maintenance Facilities:** This relates to the bus maintenance infrastructure at the terminal, and can be classified into two broad categories:
 - **On site** - Maintenance/breakdown facilities are provided inside the terminal boundary. Provisions include reserved parking bays for breakdown vehicles, space for a mini workshop, room for tools etc.

⁴ For details of bay arrangements Refer to the Interim Report – Section 2.5.1.1

- **Off Site** – Maintenance/breakdown facilities are not provided inside the terminal boundary but sourced off site, usually to local, privately operated repair workshops in the terminal’s vicinity.
8. **Passenger amenities:** This relates to the facilities provided in the terminal, for passengers’ convenience, including:
- Drinking Water
 - Toilets (Odorless & Waterless)
 - Concourse
 - Free Wi-Fi facility in waiting area
 - Eateries
 - Tourist Information
 - Cloak room
 - Ticketing
 - Dormitory
 - Baggage trolleys
9. **Terminal staff amenities:** This relates to the facilities dedicated for staff. They include:
- Drinking Water
 - Toilets (Odorless & Waterless)
 - Resting rooms
 - Canteen
 - Revenue Office
10. **Bus staff amenities:** This relates to the facilities dedicated for bus drivers and conductors (collectively known as bus staff or crew). These include:
- Drinking Water
 - Toilets (Odorless & Waterless)
 - Resting room
 - Canteen
 - Dormitory

Figure 13 presents a schematic representation of the functional attributes discussed above.

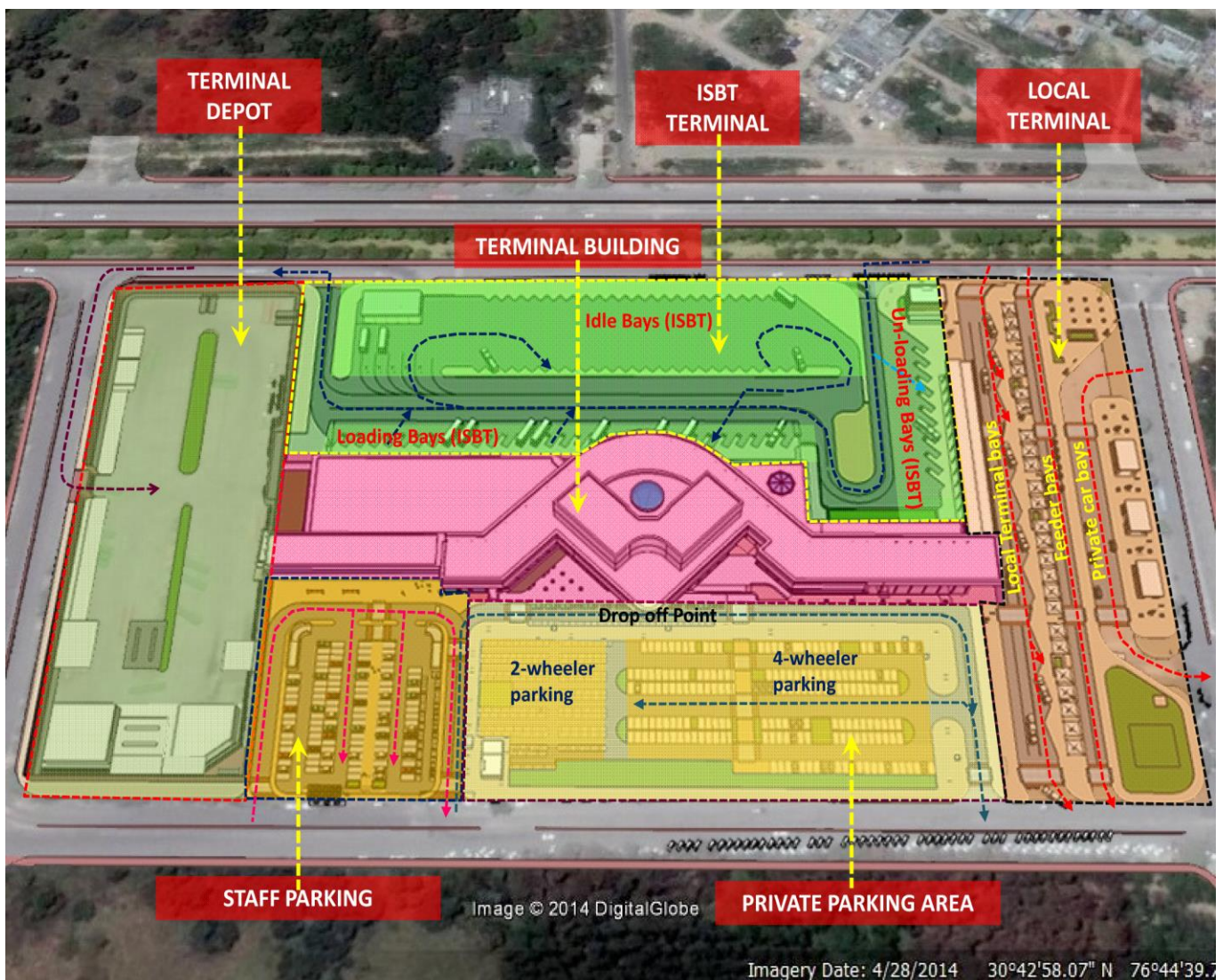

Figure 13: A schematic representation of the functional attributes in bus terminal.

A combination of the functional and operational requirements presented above, outlines the brief for planning and developing a bus terminal. Based on these requirements, a form for recording and collating the design brief has been provided below. This form is divided into two parts – A & B. Form A includes information which is gathered from observations, secondary data, and stakeholder inputs. This information includes site details, capacity requirements (or expected

demand), operational details etc. Form A also allows classification of terminals in terms of their typology and size, which guides the information gathering process in Form B. Form B records information generated by rationalizing stakeholder requirements against the planning and design recommendations included in this guideline.

FORM A - Fill up based on site observations, secondary data and stakeholder requirement					
Terminal Name			Site Area (Ha)		
Terminal (site) Location			Is site combined (Local + ISBT)? (Y/N)		
Site Status (tick one)	Existing & operational	Green field	Earmarked (not acquired)		
Observed peak hour bus flow			Planned peak hour bus flow		
Terminal Typology (tick one)	Local Bus Terminal (A)		Interstate Bus Terminal (B)		
Terminal Operation (tick one)	Fixed route-bay allocation (a)		Dynamic route-bay allocation (b)		
Terminal Typology - based on planned or horizon year flow Terminal Size (tick one)	Small (1)	Medium (2)	Large (3)		
	<= 60 buses per hour	60 to 300 buses per hour	> 300 buses per hour		
Observed average layover time (min)			Planned average layover time (min)		
Capital source for development (tick one)	100% public funding		Private equity through PPP format		
FORM B - Fill up based on guideline recommendations (section 3 and 4) and stakeholder requirements					
Site area required as per required flow (Ha)			Bus flow possible as per available site area (numbers)		
Proposed bus bay requirement (numbers)	Offloading -	Angular	Loading -	Linear	Idle -
Bus boarding bay arrangement (tick one)	Saw tooth	Angular	Perpendicular	Linear	Drive Through
Bus offloading bay arrangement (tick one)	Saw tooth	Angular	Perpendicular	Linear	Drive Through
Bus idle parking bay arrangement (tick one)	Saw tooth	Angular	Perpendicular	Linear	Drive Through
Bus maintenance infrastructure (tick one)	On Site		Off Site		
	For terminal (staff+visitors)		For real estate dev.		Total
Private vehicle parking numbers (ECS)					
Private vehicle parking type (tick one)	Structured	At Grade	At Grade+building basement	Shared	On Street
Private veh. parking arrangement (tick one)	Angled (30,45 or 60 degree)		Perpendicular	Parallel	
Feeder service infrastructure (tick one)	Intermodal		Feeder Lanes		Feeder Bays
Provision for parking and/or bays for feeder vehicles (numbers)	Auto Rick.	Cycle Rick.	Shared van/jeep	Taxi	Bus
Funding methodology - infra. dev. (tick one)	100% public funding		Private equity through PPP format		
Commercial/Real estate development (Y/N)					
Broad functionwise area requirement (sqm)	Bus Area	Private vehicle parking	Feeder-pick/drop	Circulation	Building footprint
Passenger and staff amenities					
Passenger amenities	Included (Y/N)	Area (sqm)	Terminal staff requirements	Included (Y/N)	Area (sqm)
Ticketing			Administrative office		
Arrival Concourse			Revenue Office		
Departure concourse			Drinking water		
Drinking water			Toilets		
Toilet			Resting room		
Eateries			Canteen		
Tourist information			Bus staff amenities	Included (Y/N)	Area (sqm)
Cloack room			Toilet cum bathroom		
Dormitory			Drinking water		
			Resting room		
			Canteen		
			Dormitory		
Ancillary functions - provisions and area			Additional Stakeholder Requirements		
Function	Included (Y/N)	Area (sqm)	S.No.	Requirements	
Bank/ATM			1		
Post office			2		
Railway booking office			3		
Freight services			4		

Figure 14: Design brief form



3 Planning

Under the broad bus terminal planning approach, the functional (and associated spatial) requirements for different activities in the facility, are finalized. This section assists in selecting the functions and provisions suited to various bus terminal sizes and typologies. It provides interactive graphs and tables for guidance on estimating the size and volume requirement for all activities (in the facility).

Following sub sections state how to use the information in this section. A step by step approach will allow planners and designers to put together the design brief, and all necessary information to guide the terminal design process.

Terminal design and planning starts with decisions on the terminal’s typology and proposed operations type. As already discussed (in section 2.4.1), terminals in the Indian context fall under two broad categories:

- Interstate Bus terminals (ISBT)
- Local /City Bus terminal

Terminal operations under each category are classified as:

- Fixed route bay operations
- Dynamic route operations

Each operation type can be further classified on the basis of bus flow (buses per hour) and planned layover time in the bus terminal.

This guideline places these typologies and operation types at the base for initiating terminal planning and design. Figure 15 presents the decision making process.

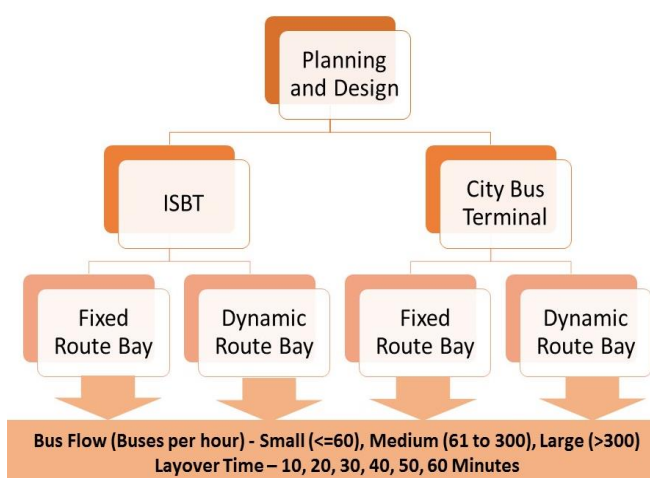

Figure 15: Decision making flow chart

In this section, a list of planning information introduces the functions and terms discussed in the guideline. Further in the section, a diagram—representing how different terminal activities and functions are related—helps visualize the necessary spatial and functional connections, and their arrangement on the site. A list of recommended functional requirements for different terminal typologies and sizes follows. Spatial requirements of each of these functions, and of the overall site, appear in the subsequent section.

3.1 Planning Assumptions

Terminology	Typology	Assumption	Area/unit
Function	ISBT	Buses connecting interstate and/or inter-district	
	Local	Buses connecting points within state boundary	
Operation	Fixed Bay Allocation	Operation already decided - Loading, Idle and Unloading at same bay.	
	Dynamic Bay Allocation	Operation already decided – loading, Idle and Unloading at different bay.	
Terminal Size	Small Type	Peak Bus flow per hour is less than 60	
	Medium Type	Peak Bus Flow per hour is between 60 and 300	
	Large Type	Peak Bus Flow per hour is greater than 300	
Bay type	Common bays	Operations taking place at same bay when layover time is less than 10 min; common in case of fixed bay allocation	
	Segregated bays	Operations taking place at different bays common in case of dynamic bay allocation	
Bus boarding Bay Type	Saw tooth bays	This arrangement allows easy docking of buses but requires long curb lengths. To avoid long continuous lengths, saw tooth bays maybe provided in parallel arrangement with passing lanes and connecting raised crossing for passenger access	217sqm/bay (preferred for offloading bays)
	Angular bays		
	60	This arrangement allows easy docking of buses with shorter curb length. This may be combined with parallel arrangement in terminals with lower bus flow	145 sqm/bay
	45		150 sqm/bay
	30		163 sqm/bay
	Perpendicular bays	Bays aligned perpendicular to concourse. Ideal arrangement for idle parking	150sqm/bay (Loading bays); 75 sqm/bay (Idle Parking)
	Drive through	The bays are parallel arrangement without passing lanes. Thus parallel boarding lanes are segregated from each other by their respective boarding bays	258 sqm/bay
Linear/parallel bays	This arrangement requires longer curb length as buses are stacked one behind the other with adequate head space. There is an overtaking lane parallel to the bus bay. One may combine it with another adjacent parallel bay with overtaking lane in between.	262 sqm/bay	
Private Vehicle Parking		2ECS/100sqm for Terminal Building and 3ECS/100sqm of commercial built-up	
	Structured	Multilevel Parking with or without mechanical lifts It is suggested to provide multilevel car parking facility for peak hour parking capacity of private vehicles more than 130	30sqm/bay (without lift); 16sqm/bay (with lift)
	At Grade	On hard surface or ground	23sqm/bay

	Shared	Multilevel or at grade parking provision is combined with miscellaneous activities in close vicinity to the site	
	On-Street	Side or shoulder parking either charged or free	
Feeder Service Integration		Car Parking (23sqm/bay); Cycle Rickshaw (19 sqm/bay); Auto Rickshaw (22 sqm/bay); Bus Drop-off bay (saw-tooth arrangement)	
		ISBT Feeder Bus service is not considered within site in case of existing bus shelter adjacent to the site	50%Bus, 20% car/Taxi, 5%Cycle Rickshaw, 10%Auto Rickshaw, 15% Cycle/Ped
		Local	2% Car, 8% Cycle, 80% Cycle/Ped, 10% Auto Rickshaw
	Intermodal	Provision for feeder bays within or adjacent to the site as per requirement	
	Lanes	Provision for feeder service along demarcated lanes	
	Bays	Feeder service allocated as per segregated bays	
Finance	PPP	Public-Private Partnership	
	Private Ownership	Private ownership	
Bus Maintenance Facility	On-site	Breakdown, repair operations provided within the site	140 sqm/bay
	Off-Site	Breakdown, repair operations available outside the site	
Passenger Amenities		Concourse (For the purpose of this manual, all amenities have been provided with standard LOS C established by ACRP for Airports)	
		Eateries It is not required in small and medium Local Terminal typologies	1.5sqm/person for 15% terminal occupancy
		Vendor/Hawker zone It is included in Local Terminal Typologies only	4sqm/vendor
		Cloak Room Not required for ISBT small and all Local Terminal Typologies	2sqm/100pax
		Dormitory (for night operations) This is not required in ISBT small Terminal typology and all Local Terminal Typologies	1bed/50pax; 6.31 sqm/bunk (Neufert, 2000)
		Ticketing It is not required in small Local Terminal Typology	22sqm/100pax
		Tourist Information It is not required in Local Terminal Typologies	0.75sqm/100pax
		Drinking Water 1/100pax (NBC 2010)	1.1 sqm/fixture



Toilets
 Male- 4 WC for first 1000 persons and 1 for every subsequent 1000 persons; 6 urinals for first 1000 persons and 1 for every subsequent 1000 persons
 Female- 5 WC for first 1000 persons and 1 for every subsequent 2000 persons
 One Indian-styled WC shall be provided in each toilet; Assume 60 male to 40 female ratios in any area
 It may include differently-abled toilet, diaper changing stations, nursing station, and family toilet (NBC 2010)







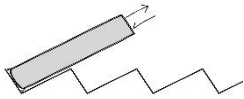
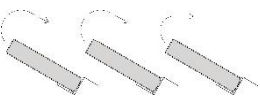
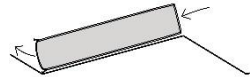

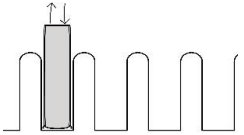
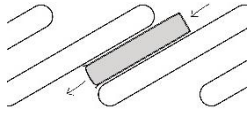
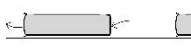
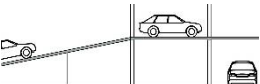

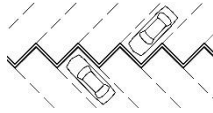



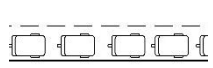
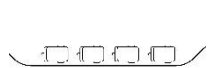

4 sqm/fixture;
 min distance between two blocks-300m

Terminal Staff Amenities	Revenue Office	10sqm/person
	Terminal Office	10sqm/person
	Railway Reservation Office	60sqm
	Standard area included in ISBT terminal only	
	Resting room	2sqm/person
	It is not required for small and medium Local Terminal and small ISBT Terminal typology	
	Canteen	2sqm/person included in office area
	It is not required for small Local Terminal Typology. This may be combined with Passenger Canteen in case of other terminal typologies	
Drinking Water (Same as above)	1.1 sqm/fixture	
Toilets (Same as above)	4 sqm/fixture; min distance between two blocks-300m (Neufert, 2000)	

Bus Staff Amenities	Dormitories (for night operations)	1bed/10 bus personnel;
	It is not required for Local Terminal Typologies	
	Resting Room	2sqm/ bus personnel for 80% bus staff
	This is not required for small and medium Local Terminal Typologies	
	Canteen	2sqm/person; 80% occupancy for bus personnel
	This may be combined with Terminal Staff Canteen incase of ISBT terminal typologies and is not required in Local Terminal typologies	
Drinking Water (Same as above)	1.1 sqm/fixture	
Toilets	4 sqm/fixture; min distance between two blocks-300m	
1 fixture per 150 bus personnel with minimum 1 fixture for male and female		

3.2 Planning Information and Considerations

Terminology	Typology	Description/Consideration	Symbol/Explanation
Function	ISBT	Inter State Bus Terminal	A
	Local	Local City Bus Terminal	B
Operation	Fixed Bay Allocation	Loading, Idle and Unloading operations taking place at same bay	a
	Dynamic Bay Allocation	Loading, Idle and Unloading operations taking place at different bays	b
Terminal Size	Small Type	Peak Bus flow per hour is less than 60	1
	Medium Type	Peak Bus Flow per hour is between 60 and 300	2
	Large Type	Peak Bus Flow per hour is greater than 300	3
Bay type	Common bays	Loading, Idle and Unloading operations taking place at same bay	
	Segregated bays	Loading, Idle and Unloading operations taking place at different bays	
Bus boarding Bay Type	Saw tooth bays	Bays arranged in saw-tooth fashion	
	Angular bays	Bays aligned parallel, at 60, 45 or 30 degrees	
	Perpendicular bays	Bays aligned parallel, at 90 degrees	
	Drive through	Bays arranged parallel at either 90, 60, 45, 30 degrees without an overtaking lane with opening for bus lanes on both sides.	
	Linear/parallel bays	Bays arranged linearly along the departure platform	
Private Vehicle Parking	Structured	Multilevel Parking with or without mechanical lifts	

Terminology	Typology	Description/Consideration	Symbol/Explanation
	At Grade	On hard surface at ground level	
	Shared	Multilevel or at grade parking provision is combined with local miscellaneous activities.	
	On-Street	Side or shoulder parking either charged or free	
Feeder Service	Intermodal	Bus, Taxi, Cycle or Auto Rickshaw Provision for feeder bays within or adjacent to the site as per requirement	
	Lanes	Provision for feeder service along demarcated lanes	
	Bays	Feeder service allocated as per segregated bays	
Finance	PPP	Public-Private Partnership. Development includes component of private equity.	
	Public Ownership	Development funded and supported by public funds with no private equity.	
Bus Maintenance Facility	On-site	Breakdown, repair operations provided within the site	
	Off-Site	Breakdown, repair services sourced outside the site	
Passenger Amenities		Concourse	
		Eateries	
		Cloak Room	
		Dormitory (for night operations)	
		Ticketing	
		Information	
		Drinking Water	
	Toilets		

Terminology	Typology	Description/Consideration	Symbol/Explanation
Terminal Staff Amenities		Revenue Office	
		Terminal Office	
		Resting room	
		Canteen	
		Drinking Water	
		Toilets	
Bus Staff Amenities		Dormitories (for night operations)	
		Resting Room	
		Canteen	
		Drinking Water	
		Toilets	

3.3 Functional Arrangement

How different terminal functions are arranged (as per their operational relationship) defines terminal planning in terms of circulation design and site layout. This section includes a graphical representation of how different terminal functions are arranged, at both interstate and local bus terminals. This helps understand

the relationship between these functions, which aids conflict-free planning of circulation (vehicular and pedestrian) associated with different activities in the bus terminal complex. Figure 16 shows how to read and use the functional arrangement plates.

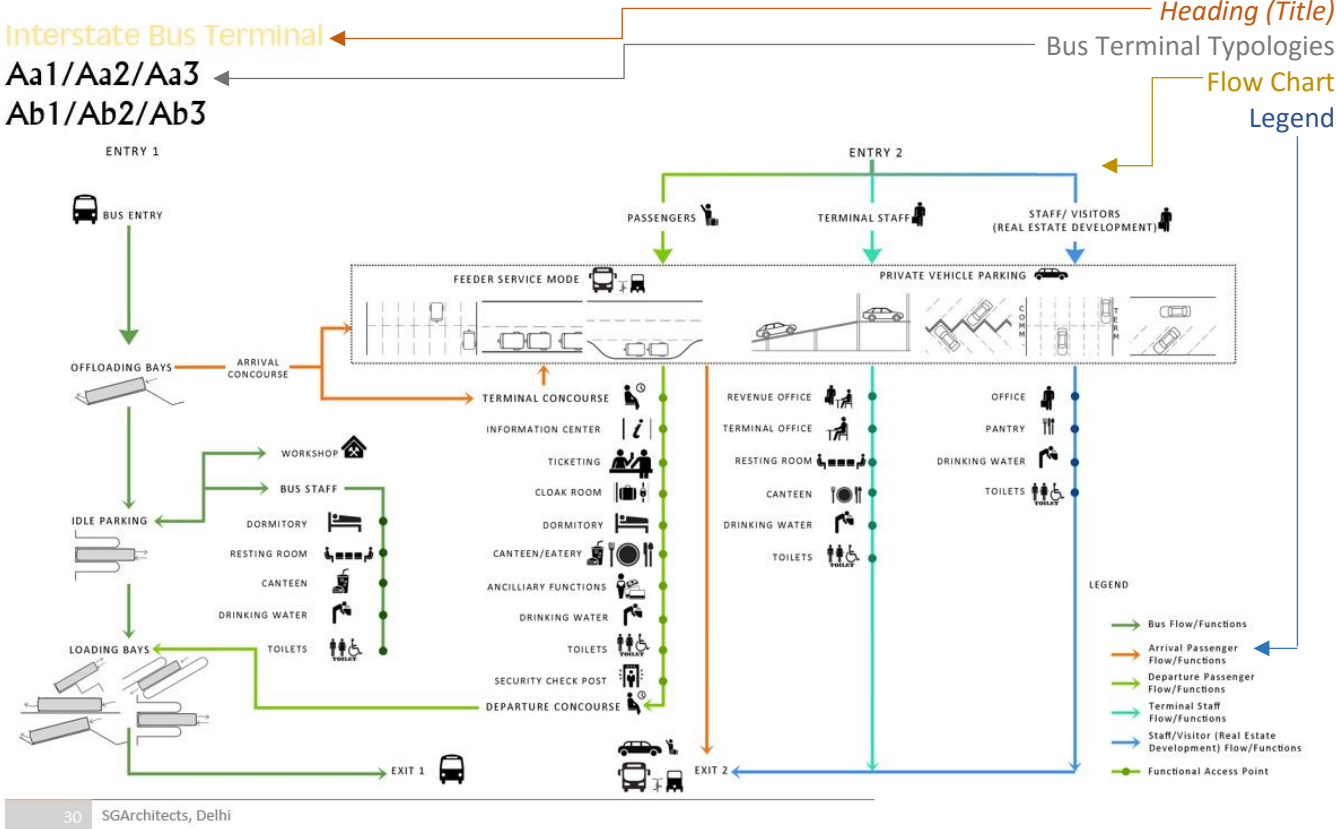

Figure 16: Methodology for using functional arrangement diagrams.

3.4 Functional Requirements

This section includes information on types (and options) of infrastructural elements related to different bus terminal functions (represented in the previous section) at an identified site. It also recommends a suitable infrastructure option for each function, based on the terminal typology, size, and operation type. Each page provides information on a single combination of bus terminal typology (interstate or local), size (small,

medium or large), and operation type (fixed route or dynamic bay). Color coding is used for recommendations - dark green represents the desirable option, standard green indicates an option to be selected under given conditions (listed for each function), and light green represents options which are not suggested for use for the given bus terminal type. Figure 17 shows how to use this section.

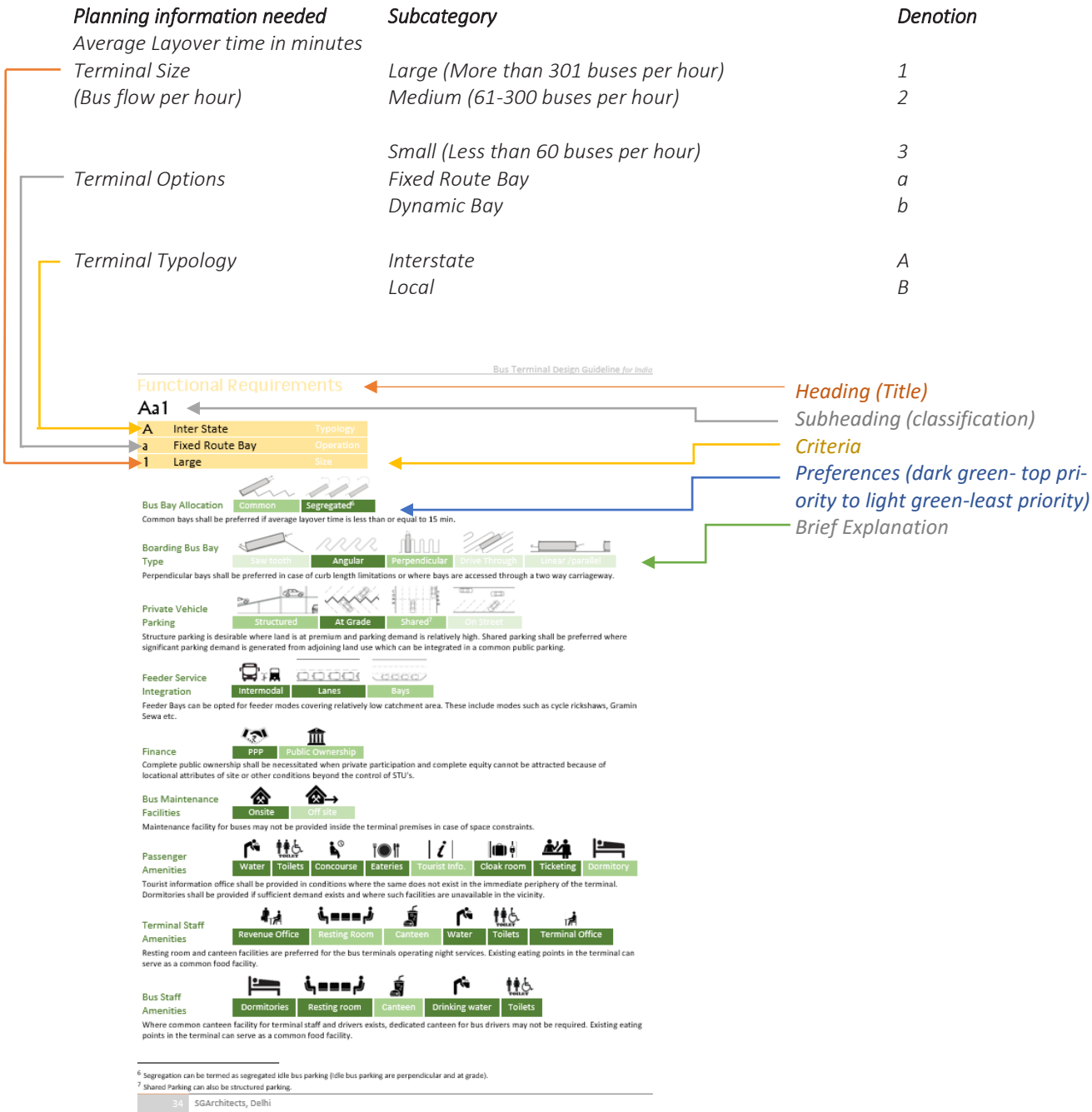

Figure 17: Methodology for using functional requirement sheets

Functional Requirements

Aa1

A	Inter State	Typology
a	Fixed Route Bay	Operation
1	Large	Size

Bus Bay Allocation

Common Segregated⁵

Common bays shall be preferred if average layover time is less than or equal to 15 min.

Boarding Bus Bay Type

Saw tooth Angular Perpendicular Drive Through Linear /parallel

Perpendicular bays shall be preferred in case of curb length limitations or where bays are accessed through a two way carriageway.

Private Vehicle Parking

Structured At Grade Shared⁶ On Street

Structure parking is desirable where land is at premium and parking demand is relatively high. Shared parking shall be preferred where significant parking demand is generated from adjoining land use which can be integrated in a common public parking.

Feeder Service Integration

Intermodal Lanes Bays

Feeder Bays can be opted for feeder modes covering relatively low catchment area. These include modes such as cycle rickshaws, Gramin Sewa etc.

Finance

PPP Public Ownership

Complete public ownership shall be necessitated when private participation and complete equity cannot be attracted because of locational attributes of site or other conditions beyond the control of STU's.

Bus Maintenance Facilities

Onsite Off site

Maintenance facility for buses may not be provided inside the terminal premises in case of space constraints.

Passenger Amenities

Water Toilets Concourse Eateries Tourist Info. Cloak room Ticketing Dormitory

Tourist information office shall be provided in conditions where the same does not exist in the immediate periphery of the terminal. Dormitories shall be provided if sufficient demand exists and where such facilities are unavailable in the vicinity.

Terminal Staff Amenities

Revenue Office Resting Room Canteen Water Toilets Terminal Office

Resting room and canteen facilities are preferred for the bus terminals operating night services. Existing eating points in the terminal can serve as a common food facility.

Bus Staff Amenities

Dormitories Resting room Canteen Drinking water Toilets

Where common canteen facility for terminal staff and drivers exists, dedicated canteen for bus drivers may not be required. Existing eating points in the terminal can serve as a common food facility.

⁵ Segregation can be termed as segregated idle bus parking (Idle bus parking are perpendicular and at grade).

⁶ Shared Parking can also be structured parking.

Functional Requirements

Ab1

Typology	Inter State	A
Operation	Dynamic Bay	b
Size	Large	1

Bus Bay Allocation

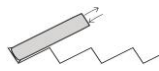

Common

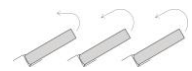

Segregated

Dynamic bay operations require segregated bays for boarding, alighting (unloading⁷) and lay-over functions (Idle Parking⁸) as the layover time is significantly high.

Boarding Bus Bay Type



Saw tooth



Angular



Perpendicular



Drive Through



Linear /parallel

Perpendicular bays shall be preferred in case of curb length limitations or where bays are accessed through a two way carriageway.

Private Vehicle Parking



Structured



At Grade



Shared⁹



On Street

Structure parking is desirable where land is at premium and parking demand is relatively high. Shared parking shall be preferred where significant parking demand is generated from adjoining land use which can be integrated in a common public parking.

Feeder Service Integration



Intermodal

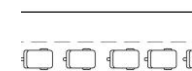

Lanes

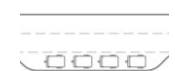

Bays

Feeder Bays can be opted for feeder modes covering relatively low catchment area. These include modes such as cycle rickshaws, Gramin Sewa etc.

Finance



PPP



Public Ownership

Complete public ownership shall be necessitated when private participation and complete equity cannot be attracted because of locational attributes of site or other conditions beyond the control of STU's.

Bus Maintenance Facilities



Onsite



Off site

Maintenance facility for buses may not be provided inside the terminal premises in case of space constraints.

Passenger Amenities



Water



Toilets



Concourse



Eateries



Tourist Info.



Cloak room



Ticketing



Dormitory

Tourist information office shall be provided in conditions where the same does not exist in the immediate periphery of the terminal. Dormitories shall be provided if sufficient demand exists and where such facilities are unavailable in the vicinity.

Terminal Staff Amenities



Revenue Office



Resting Room



Canteen



Water



Toilets



Terminal Office

Resting room and canteen facilities are preferred for the bus terminals operating night services.

Bus Staff Amenities



Dormitories



Resting room



Canteen



Drinking water



Toilets

Where common canteen facility for terminal staff and drivers exists, dedicated canteen for bus drivers may not be required.

⁷ The bays provided for unloading functions are Saw tooth and at grade.

⁸ The bays provided for Idle parking functions are perpendicular and At grade

⁹ Shared parking can also be a structured Parking.

Functional Requirements

Aa2

A	Inter State	Typology
a	Fixed Route Bay	Operation
2	Medium	Size

Bus Bay Allocation

Common Segregated¹⁰

Common bays shall be preferred if average layover time is less than or equal to 15 min. If expected layover time is long (> 15 minutes) and bus traffic is higher than 120 buses per hour; in such case segregated bays are preferred.

Boarding Bus Bay Type

Saw tooth Angular Perpendicular Drive Through Linear /parallel

Perpendicular bays shall be preferred in case of curb length limitations or where bays are accessed through a two way carriageway.

Private Vehicle Parking

Structured At Grade Shared¹¹ On Street

Structure parking is desirable where land is at premium and parking demand is relatively high. Shared parking shall be preferred where significant parking demand is generated from adjoining land use which can be integrated in a common public parking.

Feeder Service Integration

Intermodal Lanes Bays

If feeder modes frequency is high and segregated space for feeder parking is available; in such cases feeder lanes can be provided.

Finance

PPP Public Ownership

Complete public ownership shall be necessitated when private participation and complete equity cannot be attracted because of locational attributes of site or other conditions beyond the control of STU's.

Bus Maintenance Facilities

Onsite Off site

Maintenance facility for buses may not be provided inside the terminal premises in case of space constraints.

Passenger Amenities

Water Toilets Concourse Eateries Tourist Info. Cloak room Ticketing Dormitory

Tourist information office shall be provided in conditions where the same does not exist in the immediate periphery of the terminal. Dormitories shall be provided if sufficient demand exists and where such facilities are unavailable in the vicinity.

Terminal Staff Amenities

Revenue Office Resting Room Canteen Water Toilets Terminal Office

Resting room and canteen facilities are preferred for the bus terminals operating night services. Revenue office may be required based on the functional and locational attributes of the bus terminal.

Bus Staff Amenities

Dormitories Resting room Canteen Drinking water Toilets

Where common canteen facility for terminal staff and drivers exists, dedicated canteen for bus drivers may not be required.

¹⁰ Segregation can be termed as segregated idle bus parking (Idle bus parking are perpendicular and at grade).

¹¹ Shared Parking can also be structured parking.

Functional Requirements

Ab2

Typology	Inter State	A
Operation	Dynamic Bay	b
Size	Medium	2

Bus Bay Allocation

Common Segregated

Dynamic bay operations require long layover time i.e. (> 15 minutes) hence segregated bays for boarding, alighting (Unloading¹²) and lay-over functions (Idle Parking¹³) are required.

Boarding Bus Bay Type

Saw tooth Angular Perpendicular Drive Through Linear /parallel

Perpendicular bays shall be preferred in case of curb length limitations or where bays are accessed through a two way carriageway.

Private Vehicle Parking

Structured At Grade Shared¹⁴ On Street

Structure parking is desirable where land is at premium and parking demand is relatively high. Shared parking shall be preferred where significant parking demand is generated from adjoining land use which can be integrated in a common public parking.

Feeder Service Integration

Intermodal Lanes Bays

If feeder modes frequency is high and segregated space for feeder parking is available; in such cases feeder lanes can be provided.

Finance

PPP Public Ownership

Complete public ownership shall be necessitated when private participation and complete equity cannot be attracted because of locational attributes of site or other conditions beyond the control of STU's.

Bus Maintenance Facilities

Onsite Off site

Maintenance facility for buses may not be provided inside the terminal premises in case of space constraints.

Passenger Amenities

Water Toilets Concourse Eateries Tourist Info. Cloak room Ticketing Dormitory

Tourist information office shall be provided in conditions where the same does not exist in the immediate periphery of the terminal. Dormitories shall be provided if sufficient demand exists and where such facilities are unavailable in the vicinity.

Terminal Staff Amenities

Revenue Office Resting Room Canteen Water Toilets Terminal Office

Resting room and canteen facilities are preferred for the bus terminals operating night services.

Bus Staff Amenities

Dormitories Resting room Canteen Drinking water Toilets

Where common canteen facility for terminal staff and drivers exists, dedicated canteen for bus drivers may not be required. Dormitories for bus staff is preferred if the terminal is operational in night hours.

¹² The bays provided for unloading functions are Sawtooth and at grade.

¹³ The bays provided for Idle parking functions are perpendicular and At grade

¹⁴ Shared parking can also be a structured Parking.

Functional Requirements

Aa3

A	Inter State	Typology
a	Fixed Route Bay	Operation
3	Small	Size



Bus Bay Allocation Common Segregated¹⁵

If expected layover time is significantly long (> 15 minutes) and bus traffic is higher than 30 buses per hour; then segregated functions are preferred.



Boarding Bus Bay Type

Drive through bay arrangement can be opted, if the pedestrian flow in the terminal is very low. Linear/ parallel bay arrangement shall be preferred, if bus frequency in the terminal is very low i.e. (< 30 buses per hour).



Private Vehicle Parking

Structure parking is desirable where land is at premium and parking demand is relatively high. Shared parking shall be preferred where significant parking demand is generated from adjoining land use which can be integrated in a common public parking.

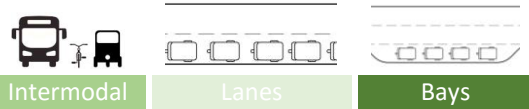

Feeder Service Integration

If Intermodal feeder service exists in near vicinity to the terminal, then shall be integrated together.



Finance

Private equity may be attracted if excess land is available and public funds are scarce.



Bus Maintenance Facilities

Maintenance facility for buses may not be provided inside the terminal premises in case of space constraints.



Passenger Amenities

Cloak room may be required if terminal is observing a higher number of long stay transit commuters. Existing eating points near terminal vicinity can serve as a common food facility for the terminal users¹⁸. Tourist information can be combined with ticketing.



Terminal Staff Amenities

Resting room shall be required for the terminals operating night services. Revenue office may not be required unless terminal has combined depot function or is has specific functional and locational requirement.



Bus Staff Amenities

Dedicated resting rooms for bus drivers may not be required where common facility for terminal staff and drivers exists.

¹⁵ Segregation can be termed as segregated idle bus parking (Idle bus parking are perpendicular and at grade).

¹⁶ Shared Parking can also be structured parking.

¹⁷ Built concourse shall be required for bus volumes higher than 30 buses per hour

¹⁸ Terminal users includes Passengers, terminal staff and bus staff

Functional Requirements

Ab3

Typology	Inter State	A
Operation	Dynamic Bay	b
Size	Small	3

Bus Bay Allocation

Common Segregated

Dynamic bay operations requires long layover time i.e. (> 15 minutes) hence segregated bays for boarding, alighting (Unloading¹⁹) and lay-over functions (Idle parking²⁰) are required.

Boarding Bus Bay Type

Saw tooth Angular Perpendicular Drive Through Linear /parallel

Linear/ parallel bay arrangement shall be preferred, if bus flow in the terminal is very low i.e. (< 30 buses per hour).

Private Vehicle Parking

Structured At Grade Shared²¹ On Street

Structure parking is desirable where land is at premium and parking demand is relatively high. Shared parking shall be preferred where significant parking demand is generated from adjoining land use which can be integrated in a common public parking.

Feeder Service Integration

Intermodal Lanes Bays

If Intermodal feeder service exists in near vicinity to the terminal, then shall be integrated together.

Finance

PPP Public Ownership

Private equity may be attracted if excess land is available and public funds are scarce.

Bus Maintenance Facilities

Onsite Off site

Maintenance facility for buses may not be provided inside the terminal premises in case of space constraints.

Passenger Amenities

Water Toilets Concourse²² Eateries Tourist Info. Cloak room Ticketing Dormitory

Cloak room may be required if terminal is observing a higher number of long stay transit commuters. Existing eating points near terminal vicinity can serve as a common food facility for the terminal users²³. Tourist information can be combined with ticketing.

Terminal Staff Amenities

Revenue Office Resting Room Canteen Water Toilets Terminal Office

Resting room shall be required for the terminals operating night services. Revenue office may not be required unless terminal has some significant functional and locational attributes.

Bus Staff Amenities

Dormitories Resting room Canteen Drinking water Toilets

Dedicated resting rooms for bus drivers may not be required where common facility for terminal staff and drivers exists.

¹⁹ The bays provided for unloading functions are Saw tooth and at grade.

²⁰ The bays provided for Idle parking functions are perpendicular and At grade

²¹ Shared parking can also be a structured Parking.

²² Built concourse shall be required for bus volumes higher than 30 buses per hour

²³ Terminal users includes Passengers, terminal staff and bus staff

Functional Requirements

Ba1

B	Local	Typology
a	Fixed Route Bay	Operation
1	Large	Size

Bus Bay Allocation

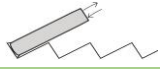
 Common

 Segregated²⁴

Common bays shall be preferred if average layover time is less than or equal to 10 min.

Boarding Bus Bay Type

 Saw tooth

 Angular

 Perpendicular

 Drive Through²⁵

 Linear /parallel

Drive through may be preferred for layover time less than 20 min and bus flow is less than 400 buses per hour. Angular bays can be provided if the terminal layover time is greater than 20 min or more and bus flow is in excess of 400 buses per hour.

Private Vehicle Parking²⁶

 Structured

 At Grade

 Shared

 On Street

Shared parking shall be preferred where significant parking demand is generated from adjoining land use which can be integrated in a common public parking which may be at grade or structured.

Feeder Service Integration

 Intermodal

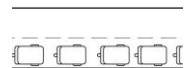
 Lanes

 Bays

Feeder Bays provide simultaneous short term parking and pickup facility.

Finance

 PPP

 Public Ownership

Complete public ownership shall be necessitated when private participation and complete equity cannot be attracted because of locational attributes of site or other conditions beyond the control of STU's.

Bus Maintenance Facilities

 Onsite

 Off site

Maintenance facility for buses may not be provided inside the terminal premises in case of space constraints.

Passenger Amenities

 Water

 Toilets

 Concourse

 Eateries

 Tourist Info.

 Cloak room

 Ticketing

 Dormitory

Existing eating points near terminal vicinity can serve as a common food facility for the passengers. For monthly pass facility dedicated (Ticket) counter can be provided or can be clubbed with the terminal office.

Terminal Staff Amenities

 Revenue Office

 Resting Room

 Canteen

 Water

 Toilets

 Terminal Office

Resting room and canteen are preferred for bus terminals operating night services. Revenue office may be required if terminal has combined depot function or if there exists other specific functional and locational requirements.

Bus Staff Amenities

 Dormitories

 Resting room

 Canteen

 Water

 Toilets

Facilities like water and toilets can be combined with terminal staff facilities. Dedicated facilities for bus drivers may not be required.

²⁴ Segregation can be termed as segregated idle bus parking (Idle bus parking are perpendicular and at grade).

²⁵ It is also possible to provide Drive through bays, in stack of 10 to 15 bays each.

²⁶ Parking in Local Terminals is for usage of staff and to cater real estate development parking demand.

Functional Requirements

Bb1

Typology	Local	B
Operation	Dynamic Bay	b
Size	Large	1

Bus Bay Allocation

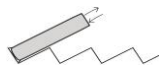
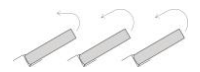
Common
Segregated

Dynamic bay operations require segregated bays for boarding, alighting (Unloading- Provided with At grade Sawtooth bays) and lay-over functions (Idle-Parking – Provided with at grade perpendicular bays) as the layover time is significantly high(>10Min).

Boarding Bus Bay Type









Saw tooth
Angular
Perpendicular
Drive Through²⁷
Linear /parallel

Linear/Parallel bay can be opted if bus frequency is lower than 60 bus/hour with more circulation space available else in case of site/area constraints Sawtooth bays can opted.

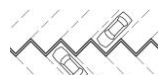

Private Vehicle Parking²⁸

Structured
At Grade
Shared
On Street

Shared parking shall be preferred where significant parking demand is generated from adjoining land use which can be integrated in a common public parking which may be at grade or structured.

Feeder Service Integration

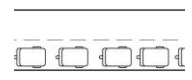
Intermodal
Lanes
Bays

Feeder Bays provide simultaneous short term parking and pickup facility.

Finance



PPP
Public Ownership

Complete public ownership shall be necessitated when private participation and complete equity cannot be attracted because of locational attributes of site or other conditions beyond the control of STU's.

Bus Maintenance Facilities



Onsite
Off site

Maintenance facility for buses may not be provided inside the terminal premises in case of space constraints.

Passenger Amenities









Water
Toilets
Concourse
Eateries
Tourist Info.
Cloak room
Ticketing
Dormitory

Existing eating points near terminal vicinity can serve as a common food facility for passengers. For monthly pass facility separate (Ticket) counter can be provided or can be clubbed with the terminal office.

Terminal Staff Amenities







Revenue Office
Resting Room
Canteen
Water
Toilets
Terminal Office

Resting room and canteen are preferred for bus terminals operating night services. Revenue office may be required if terminal has combined depot function or if there exists other specific functional and locational requirements.

Bus Staff Amenities







Dormitories
Resting room
Canteen
Drinking water
Toilets

Facilities like water and toilets can be combined with facility for terminal staff. Dedicated facilities for bus drivers may not be required.

²⁷ In case of dynamic bay operations, Drive through bus boarding bays should be integrated with strong PIS System for proper functioning.

²⁸ Parking in Local Terminals is for usage of staff and to cater real estate development parking demand

Functional Requirements

Ba2

B	Local	Typology
a	Fixed Route bay	Operation
2	Medium	Size



Bus Bay Allocation

- Common
- Segregated²⁹

Common bays shall be preferred if average layover time is less than or equal to 10 min. If expected layover time is long (> 15 minutes) and bus traffic is higher than 120 buses per hour; in such case segregated bays are preferred.

Boarding Bus Bay Type



Sawtooth may be used where bus flow is more than 120 buses per hour and layover time is less than 20 min with parallel curbs available. Angular bays may be used when layover time is more than 20 min.

Private Vehicle Parking³¹



Shared parking shall be preferred where significant parking demand is generated from adjoining land use which can be integrated in a common public parking, at grade or structured.

Feeder Service Integration

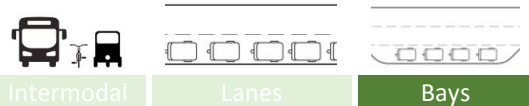

Feeder Bays provide simultaneous short term parking and pickup facility.

Finance



Complete public ownership shall be necessitated when private participation and complete equity cannot be attracted because of locational attributes of site or other conditions beyond the control of STU's.

Bus Maintenance Facilities



Maintenance facility for buses may not be provided inside the terminal premises in case of space constraints.

Passenger Amenities



Ticket counters may not be required as on-board ticketing is available for such terminals but in case of issuing monthly travel pass a facility can be provided separately or can be clubbed with the terminal office.

Terminal Staff Amenities



Resting room and canteen are preferred for bus terminals operating night services.

Bus Staff Amenities



Where common rest room facility for terminal staff and drivers exists, dedicated rest room for bus drivers may not be required. Other Facilities like water and toilets can be combined with facility for terminal staff

²⁹ Segregation can be termed as segregated idle bus parking

³⁰ Drive through bus boarding bays should be integrated with strong PIS System for proper functioning.

³¹ Parking in Local Terminals is for usage of staff and to cater real estate development parking demand.

Functional Requirements

Bb2

Typology	Local	B
Operation	Dynamic Bay	b
Size	Medium	2

Bus Bay Allocation

Common Segregated

Dynamic bay operations requires long layover time i.e. (> 10 minutes) hence segregated bays for boarding, alighting (Unloading- Provided with Sawtooth at grade) and lay-over functions (Idle parking- Provided with at grade perpendicular bays) are required.

Boarding Bus Bay Type

Saw tooth Angular Perpendicular Drive Through³² Linear /parallel

Linear/Parallel bay will be preferred if bus flow per hour is smaller than 200 bus/hour and in case bus flow is greater than 200 bus per hour than Drive through bays can be preferred.

Private Vehicle Parking³³

Structured At Grade Shared³⁴ On Street

Shared parking shall be preferred where significant parking demand is generated from adjoining land use which can be integrated in a common public parking.

Feeder Service Integration

Intermodal Lanes Bays

Feeder Bays provide simultaneous short term parking and pickup facility.

Finance

PPP Public Ownership

Complete public ownership shall be necessitated when private participation and complete equity cannot be attracted because of locational attributes of site or other conditions beyond the control of STU's.

Bus Maintenance Facilities

Onsite Off site

Maintenance facility for buses may not be provided inside the terminal premises in case of space constraints.

Passenger Amenities

Water Toilets Concourse Eateries Tourist Info. Cloak room Ticketing Dormitory

Ticket counters may not be required as on-board ticketing is available for such terminals but in case of issuing monthly travel pass a facility can be provided separately or can be clubbed with the terminal office.

Terminal Staff Amenities

Revenue Office Resting Room Canteen Water Toilets Terminal Office

Resting room and canteen facilities are preferred for the bus terminals operating night services.

Bus Staff Amenities

Dormitories Resting room Canteen Drinking water Toilets

Where common rest room facility for terminal staff and drivers exists, dedicated rest room for bus drivers may not be required. Other Facilities like water and toilets can be combined with facility for terminal staff.

³² Strong PIS system is required if bus flow per hour is higher than 200 buses and drive through bays are provided.

³³ Parking in Local Terminals is for usage of staff and to cater real estate development parking demand

³⁴ Shared Parking can also be structured parking.

Functional Requirements

Ba3

B	Local	Typology
a	Fixed Route Bay	Operation
3	Small	Size



Bus Bay Allocation Common Segregated³⁵

If expected layover time is significantly long (> 10 minutes) and bus traffic is higher than 30 buses per hour; segregated bays for boarding, alighting and lay-over functions are preferred.



Boarding Bus Bay Type

Saw tooth Angular Perpendicular Drive Through³⁶ Linear /parallel

Saw tooth may be provided where the shape of site does not permit drive through bay provisions. Linear/ parallel bays can be preferred, in case site is linear along the carriage way with bus flow <= 30 buses per hour and layover time is less than 20 minutes.

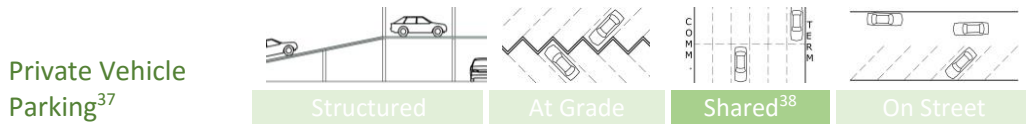

Private Vehicle Parking³⁷

Structured At Grade Shared³⁸ On Street

Shared parking shall be preferred where significant parking demand is generated from adjoining land use which can be integrated in a common public parking.

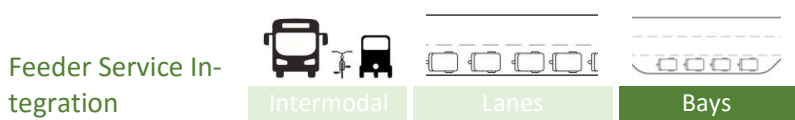

Feeder Service Integration

Intermodal Lanes Bays

Feeder Bays provide simultaneous short term parking and pickup facility.



Finance

PPP Public Ownership

Private equity may be attracted if excess land is available and public funds are scarce.



Bus Maintenance Facilities

Onsite Off site

Maintenance facility for buses may not be provided inside the terminal premises in case of space constraints.

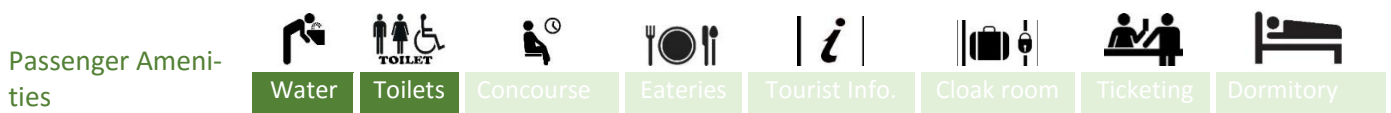

Passenger Amenities

Water Toilets Concourse Eateries Tourist Info. Cloak room Ticketing Dormitory

Facilities like drinking water and toilets can be amalgamated with the nearby provisions.

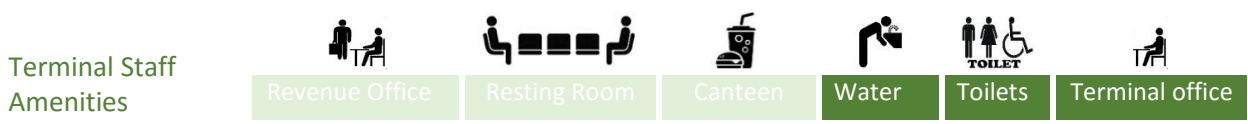

Terminal Staff Amenities

Revenue Office Resting Room Canteen Water Toilets Terminal office

Facilities like drinking water and toilets can be amalgamated with the nearby provisions



Bus Staff Amenities

Dormitories Resting room Canteen Drinking water Toilets

Segregated facilities for bus staff may not be required in small local terminals. All the required facilities can be combined with the terminal staff amenities provided.

³⁵ Segregation can be termed as segregated idle bus parking. (Idle bus parking are perpendicular and At grade)

³⁶ Drive through bus boarding bays should be integrated with strong PIS System for proper functioning.

³⁷ Parking in Local Terminals is primarily for usage of staff and to cater real estate development parking demand.

³⁸ Shared Parking can also be structured parking.

Functional Requirements

Bb3

Typology	Local	B
Operation	Dynamic Bay	b
Size	Small	3

Bus Bay Allocation



Common

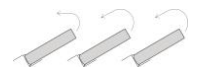

Segregated

Dynamic bay operations require long layover time i.e. (> 10 min) hence segregated bays for boarding, alighting (Unloading - Provided with at grade Saw tooth bays) and lay-over functions (Idle parking – provided with perpendicular bays) are required.

Boarding Bus Bay Type



Saw tooth



Angular



Perpendicular



Drive Through



Linear /parallel

In case of restricted curb length Saw tooth bus bays can be implemented in the design.

Private Vehicle Parking³⁹



Structured



At Grade

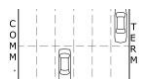

Shared



On Street

Shared parking shall be preferred where significant parking demand is generated from adjoining land use which can be integrated in a common public parking.

Feeder Service Integration



Intermodal

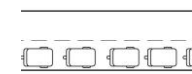

Lanes



Bays

Feeder Bays provide simultaneous short term parking and pickup facility

Finance



PPP



Public Ownership

Private equity may be attracted if excess land is available and public funds are scarce.

Bus Maintenance Facilities



Onsite



Off site

Maintenance facility for buses may not be provided inside the terminal premises in case of space constraints.

Passenger Amenities



Water



Toilets



Concourse⁴⁰



Eateries



Tourist Info.



Cloak room



Ticketing



Dormitory

Facilities like drinking water and toilets can be amalgamated with the nearby provisions.

Terminal Staff Amenities



Revenue Office



Resting Room



Canteen



Water



Toilets



Terminal Office

Facilities like drinking water and toilets can be amalgamated with the nearby provisions.

Bus Staff Amenities



Dormitories



Resting room



Canteen



Drinking water



Toilets

Segregated facilities for bus staff may not be required in small local terminals. All the required facilities can be combined with nearby amenities provided.

³⁹ Parking in Local Terminals is for usage of staff and to cater any real estate development parking demand

3.5 Spatial Requirements

Each terminal function consumes finite space on the site. Knowledge of the space requirement associated with different functions is necessary for planning the terminal. Information on the area required to develop infrastructure for these functions, makes it possible to spatially arrange the functions, towards efficient functioning of the terminal. This section lists (using graphs presented in Annexure 4 - Spatial Requirement Charts for Bus Terminals) spatial requirements for the overall site of a terminal and the disaggregated functions, in relation to average layover time and expected (or planned for) bus flow per hour.

Figure 18 shows how to use these graphs in the design and planning process. As an example, site area required (in hectares) for different bus flow per hour requirements has been presented below.

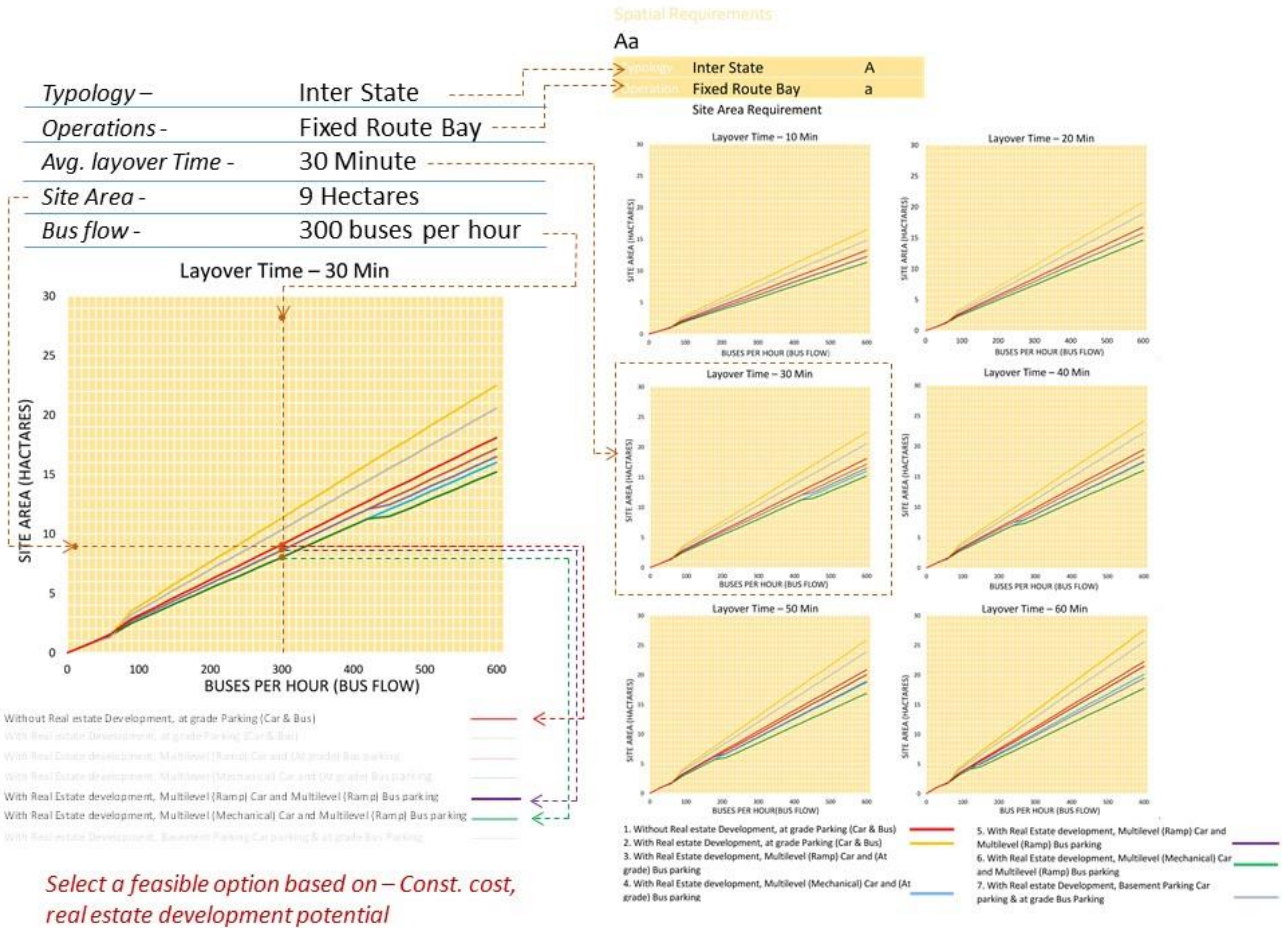

Figure 18: Methodology for using spatial requirement graphs (example graph – site area against bus flow per hour)

Feasible development options can be assessed based on the available site area, stakeholder requirements, and demand in terms of bus flow per hour. The planner selects a development option after evaluating each on the criteria of associated developmental requirement, market, and financial viability. For the purpose, the following type of graphs are worked out:

- Bus flow against site area
- Bus flow against car parking demand
- Bus flow against bus bay requirements
- Bus flow against passenger flow and accumulation
- Bus flow against F.A.R.
- Bus flow against built up area
- Bus flow against parking built up area
- Percentage wise breakup of site area allocation to functions
- Percentage wise breakup of open space
- Percentage wise breakup of built up space
- Percentage wise breakup of at grade bus parking area
- Percentage wise breakup of multilevel bus parking area

**All the above mentioned graphs are presented in Annexure 4 - Spatial Requirement Charts for Bus Terminals.*

The bus flow versus area graph presents seven development scenarios. These include one scenario with no real estate development (without PPP) and six with different PPP development options, including:

- at grade bus parking
- at grade car parking
- Multilevel car parking (with ramps)
- Multi-level mechanized car parking
- Multi-level bus parking (with ramps)
- Basement (of terminal building) car parking

**All the above mentioned graphs are presented in Annexure 4 - Spatial Requirement Charts for Bus Terminals.*

Rest of the graphs present percentage wise breakup relationships for all seven development scenarios, with respect to the terminal type (interstate or local) and terminal size (small, medium and large). Figure 19 describes the seven scenarios. The graphs in the Annexure 4 - Spatial Requirement Charts for Bus Terminals are in same chronology as in Figure 19.

- Scenario 1: Without Real estate Development (No commercial) and at grade car & Bus Parking.
- Scenario 2: With Real estate Development, at-grade Parking (Car & Bus).
- Scenario 3: With Real Estate development, Multilevel (Ramp) Car and (At grade) Bus parking.
- Scenario 4: With Real Estate development, Multilevel (Mechanical) Car parking and (At grade) Bus parking.
- Scenario 5: With Real Estate development, Multilevel (Ramp) Car parking and Multilevel (Ramp) Bus Parking.
- Scenario 6: With Real Estate development, Multilevel (Mechanical) Car parking and Multilevel (Ramp) Bus parking.
- Scenario 7: With Real estate Development, Basement Car parking & at grade Bus Parking.

Figure 19: Scenario Description

3.5.1 How to use spatial requirements charts?

Annexure 4 - Spatial Requirement Charts for Bus Terminals includes spatial requirement charts for seven scenarios of bus terminal planning. All charts relate to bus flow per hour and average layover time. The guide provided below directs (by page number) to relevant charts for selected option.

SCENARIO - 1	Without Real Estate Development (No commercial) and at grade car & Bus Parking	Chart Name	Interstate Fixed	Interstate Dynamic	Local Fixed	Local Dynamic
		Bus flow against site area	Pg No. 116	Pg No. 117	Pg No. 164	Pg No. 165
		Bus flow against car parking demand	Pg No. 118	Pg No. 119	Pg No. 166	Pg No. 167
		Bus flow against bus bay requirements	Pg No. 120	Pg No. 121	Pg No. 168	Pg No. 169
		Bus flow against passenger flow and accumulation.	Pg No. 122	Pg No. 123	Pg No. 170	Pg No. 171
		Bus flow against floor area ratio (F.A.R)	Pg No. 124	Pg No. 125	Pg No. 172	Pg No. 173
		Bus flow against built up area	Pg No. 126	Pg No. 127	Pg No. 174	Pg No. 175
		Bus flow against parking built up area	Pg No. 128	Pg No. 129	Pg No. 176	Pg No. 177
		Percentage wise breakup of site area allocation to functions	Pg No. 130	Pg No. 144	Pg No. 178	Pg No. 192
		Percentage wise breakup of open space	Pg No. 131	Pg No. 145	Pg No. 179	Pg No. 193
		Percentage wise breakup of built up space	Pg No. 158	Pg No. 159	Pg No. 206	Pg No. 207
		Percentage wise breakup of at grade bus parking area	Pg No. 160	Pg No. 161	Pg No. 208	Pg No. 209
		Percentage wise breakup of multilevel bus parking area	Pg No. 162	Pg No. 163	Pg No. 210	Pg No. 211

SCENARIO - 2	With Real Estate Development and at-grade Parking (Car & Bus)	Chart Name	Interstate Fixed	Interstate Dynamic	Local Fixed	Local Dynamic
		Bus flow against site area	Pg No. 116	Pg No. 117	Pg No. 164	Pg No. 165
		Bus flow against car parking demand	Pg No. 118	Pg No. 119	Pg No. 166	Pg No. 167
		Bus flow against bus bay requirements	Pg No. 120	Pg No. 121	Pg No. 168	Pg No. 169
		Bus flow against passenger flow and accumulation.	Pg No. 122	Pg No. 123	Pg No. 170	Pg No. 171
		Bus flow against floor area ratio (F.A.R)	Pg No. 124	Pg No. 125	Pg No. 172	Pg No. 173
		Bus flow against built up area	Pg No. 126	Pg No. 127	Pg No. 174	Pg No. 175
		Bus flow against parking built up area	Pg No. 128	Pg No. 129	Pg No. 176	Pg No. 177
		Percentage wise breakup of site area allocation to functions	Pg No. 132	Pg No. 146	Pg No. 180	Pg No. 194
		Percentage wise breakup of open space	Pg No. 133	Pg No. 147	Pg No. 181	Pg No. 195
		Percentage wise breakup of built up space	Pg No. 158	Pg No. 159	Pg No. 206	Pg No. 207
		Percentage wise breakup of at grade bus parking area	Pg No. 160	Pg No. 161	Pg No. 208	Pg No. 209
		Percentage wise breakup of multilevel bus parking area	Pg No. 162	Pg No. 163	Pg No. 210	Pg No. 211

SCENARIO - 3	With Real Estate development, Multi-level (Ramp) Car and (At grade) Bus parking	Chart name	Interstate Fixed	Interstate Dynamic	Local Fixed	Local Dynamic
		Bus flow against site area	Pg No. 116	Pg No. 117	Pg No. 164	Pg No. 165
		Bus flow against car parking demand	Pg No. 118	Pg No. 119	Pg No. 166	Pg No. 167
		Bus flow against bus bay requirements	Pg No. 120	Pg No. 121	Pg No. 168	Pg No. 169
		Bus flow against passenger flow and accumulation.	Pg No. 122	Pg No. 123	Pg No. 170	Pg No. 171
		Bus flow against floor area ratio (F.A.R)	Pg No. 124	Pg No. 125	Pg No. 172	Pg No. 173
		Bus flow against built up area	Pg No. 126	Pg No. 127	Pg No. 174	Pg No. 175
		Bus flow against parking built up area	Pg No. 128	Pg No. 129	Pg No. 176	Pg No. 177
		Percentage wise breakup of site area allocation to functions	Pg No. 134	Pg No. 148	Pg No. 182	Pg No. 196
		Percentage wise breakup of open space	Pg No. 135	Pg No. 149	Pg No. 183	Pg No. 197
		Percentage wise breakup of built up space	Pg No. 158	Pg No. 159	Pg No. 206	Pg No. 207
		Percentage wise breakup of at grade bus parking area	Pg No. 160	Pg No. 161	Pg No. 208	Pg No. 209
		Percentage wise breakup of multilevel bus parking area	Pg No. 162	Pg No. 163	Pg No. 210	Pg No. 211

SCENARIO - 4	With Real Estate development, Multi-level (Mechanical) Car parking and (At grade) Bus parking	Chart name	Interstate Fixed	Interstate Dynamic	Local Fixed	Local Dynamic
		Bus flow against site area	Pg No. 116	Pg No. 117	Pg No. 164	Pg No. 165
		Bus flow against car parking demand	Pg No. 118	Pg No. 119	Pg No. 166	Pg No. 167
		Bus flow against bus bay requirements	Pg No. 120	Pg No. 121	Pg No. 168	Pg No. 169
		Bus flow against passenger flow and accumulation.	Pg No. 122	Pg No. 123	Pg No. 170	Pg No. 171
		Bus flow against floor area ratio (F.A.R)	Pg No. 124	Pg No. 125	Pg No. 172	Pg No. 173
		Bus flow against built up area	Pg No. 126	Pg No. 127	Pg No. 174	Pg No. 175
		Bus flow against parking built up area	Pg No. 128	Pg No. 129	Pg No. 176	Pg No. 177
		Percentage wise breakup of site area allocation to functions	Pg No. 136	Pg No. 150	Pg No. 184	Pg No. 198
		Percentage wise breakup of open space	Pg No. 137	Pg No. 151	Pg No. 185	Pg No. 199
Percentage wise breakup of built up space	Pg No. 158	Pg No. 159	Pg No. 206	Pg No. 207		
Percentage wise breakup of at grade bus parking area	Pg No. 160	Pg No. 161	Pg No. 208	Pg No. 209		
Percentage wise breakup of multilevel bus parking area	Pg No. 162	Pg No. 163	Pg No. 210	Pg No. 211		

SCENARIO - 5	With Real Estate development, Multi-level (Ramp) Car parking and Multilevel (Ramp) Bus parking	Chart name	Interstate Fixed	Interstate Dynamic	Local Fixed	Local Dynamic
		Bus flow against site area	Pg No. 116	Pg No. 117	Pg No. 164	Pg No. 165
		Bus flow against car parking demand	Pg No. 118	Pg No. 119	Pg No. 166	Pg No. 167
		Bus flow against bus bay requirements	Pg No. 120	Pg No. 121	Pg No. 168	Pg No. 169
		Bus flow against passenger flow and accumulation.	Pg No. 122	Pg No. 123	Pg No. 170	Pg No. 171
		Bus flow against floor area ratio (F.A.R)	Pg No. 124	Pg No. 125	Pg No. 172	Pg No. 173
		Bus flow against built up area	Pg No. 126	Pg No. 127	Pg No. 174	Pg No. 175
		Bus flow against parking built up area	Pg No. 128	Pg No. 129	Pg No. 176	Pg No. 177
		Percentage wise breakup of site area allocation to functions	Pg No. 138	Pg No. 152	Pg No. 186	Pg No. 200
		Percentage wise breakup of open space	Pg No. 139	Pg No. 153	Pg No. 187	Pg No. 201
Percentage wise breakup of built up space	Pg No. 158	Pg No. 159	Pg No. 206	Pg No. 207		
Percentage wise breakup of at grade bus parking area	Pg No. 160	Pg No. 161	Pg No. 208	Pg No. 209		
Percentage wise breakup of multilevel bus parking area	Pg No. 162	Pg No. 163	Pg No. 210	Pg No. 211		

SCENARIO - 6	With Real Estate development, Multi-level (Mechanical) Car parking and Multi-level (Ramp) Bus parking	Chart name	Interstate Fixed	Interstate Dynamic	Local Fixed	Local Dynamic
		Bus flow against site area	Pg No. 116	Pg No. 117	Pg No. 164	Pg No. 165
		Bus flow against car parking demand	Pg No. 118	Pg No. 119	Pg No. 166	Pg No. 167
		Bus flow against bus bay requirements	Pg No. 120	Pg No. 121	Pg No. 168	Pg No. 169
		Bus flow against passenger flow and accumulation.	Pg No. 122	Pg No. 123	Pg No. 170	Pg No. 171
		Bus flow against floor area ratio (F.A.R)	Pg No. 124	Pg No. 125	Pg No. 172	Pg No. 173
		Bus flow against built up area	Pg No. 126	Pg No. 127	Pg No. 174	Pg No. 175
		Bus flow against parking built up area	Pg No. 128	Pg No. 129	Pg No. 176	Pg No. 177
		Percentage wise breakup of site area allocation to functions	Pg No. 140	Pg No. 154	Pg No. 188	Pg No. 202
		Percentage wise breakup of open space	Pg No. 141	Pg No. 155	Pg No. 189	Pg No. 203
Percentage wise breakup of built up space	Pg No. 158	Pg No. 159	Pg No. 206	Pg No. 207		
Percentage wise breakup of at grade bus parking area	Pg No. 160	Pg No. 161	Pg No. 208	Pg No. 209		
Percentage wise breakup of multilevel bus parking area	Pg No. 162	Pg No. 163	Pg No. 210	Pg No. 211		

SCENARIO - 7	With Real Estate Development, Base-ment Car parking & at grade Bus Parking	Chart name	Interstate Fixed	Interstate Dynamic	Local Fixed	Local Dynamic
		Bus flow against site area	Pg No. 116	Pg No. 117	Pg No. 164	Pg No. 165
		Bus flow against car parking demand	Pg No. 118	Pg No. 119	Pg No. 166	Pg No. 167
		Bus flow against bus bay requirements	Pg No. 120	Pg No. 121	Pg No. 168	Pg No. 169
		Bus flow against passenger flow and accumulation.	Pg No. 122	Pg No. 123	Pg No. 170	Pg No. 171
		Bus flow against floor area ratio (F.A.R)	Pg No. 124	Pg No. 125	Pg No. 172	Pg No. 173
		Bus flow against built up area	Pg No. 126	Pg No. 127	Pg No. 174	Pg No. 175
		Bus flow against parking built up area	Pg No. 128	Pg No. 129	Pg No. 176	Pg No. 177
		Percentage wise breakup of site area allocation to functions	Pg No. 140	Pg No. 156	Pg No. 190	Pg No. 204
		Percentage wise breakup of open space	Pg No. 141	Pg No. 157	Pg No. 191	Pg No. 205
Percentage wise breakup of built up space	Pg No. 158	Pg No. 159	Pg No. 206	Pg No. 207		
Percentage wise breakup of at grade bus parking area	Pg No. 160	Pg No. 161	Pg No. 208	Pg No. 209		
Percentage wise breakup of multilevel bus parking area	Pg No. 162	Pg No. 163	Pg No. 210	Pg No. 211		



4 Designing

Bus terminal designing involves consideration of all factors necessary for execution of the project at site. This includes the following:

- Arranging all infrastructure and planning elements with a detailed dimensional understanding, to ensure functional effectiveness of the facility.
- Aesthetic and visual considerations for improved spatial experience and comfort for users
- Installing modern techniques like Intelligent Transport Systems (ITS), and planning services that ensure not only user comfort and smooth functioning of the terminal but also user safety and security
- Applying an understanding of construction processes, finishes and specifications, to ensure that the plans are implementable
- Applying standards and norms to ensure that the built infrastructure not only functions efficiently but complies with all statutory requirements

This sections provides information on the following different design aspects:

- Geometric design standards
- ITS
- Services
- Typical details

4.1 Geometric Design Standards

A bus terminal site requires planning for significant bus—and other vehicular (cars and motorized two wheelers)—circulation within the terminal. This requires development of vehicular infrastructure in the form of carriageways, driveways, parking, and bays (for different purposes) within the terminal complex. The design for these (vehicular infrastructure) is based on the dimensions of vehicles and related standards. This section includes few of the critical geometric design standards for vehicular circulation within the terminal. Based on recommendations from ASVV Record 15 (CROW 1998) published in the Netherlands, these standards include:

- Geometric design standards for bus and car
- Car parking standards
- Bus parking standards
- Bus bay standards

02

- 90 degree Bus Boarding Bay a
- 60 Degree Bus Boarding Bay b
- 45 Degree Bus Boarding Bay c

BUS BOARDING BAY WITH 100M LENGTH

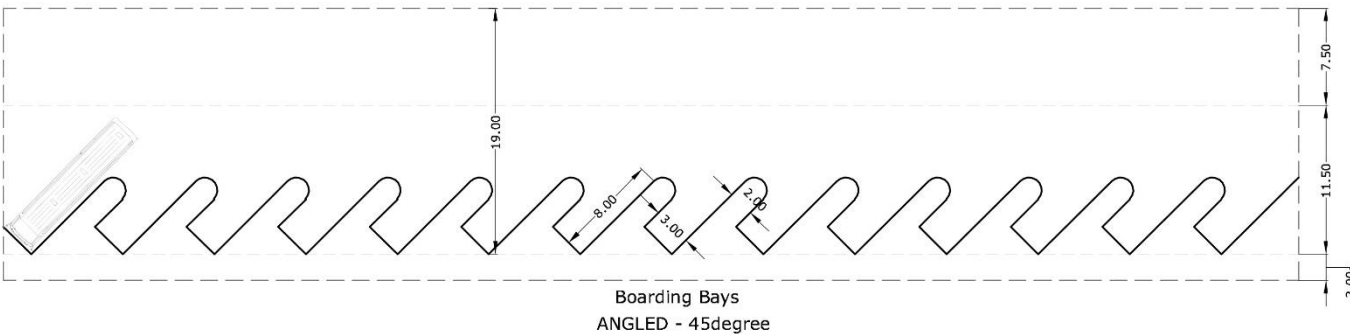
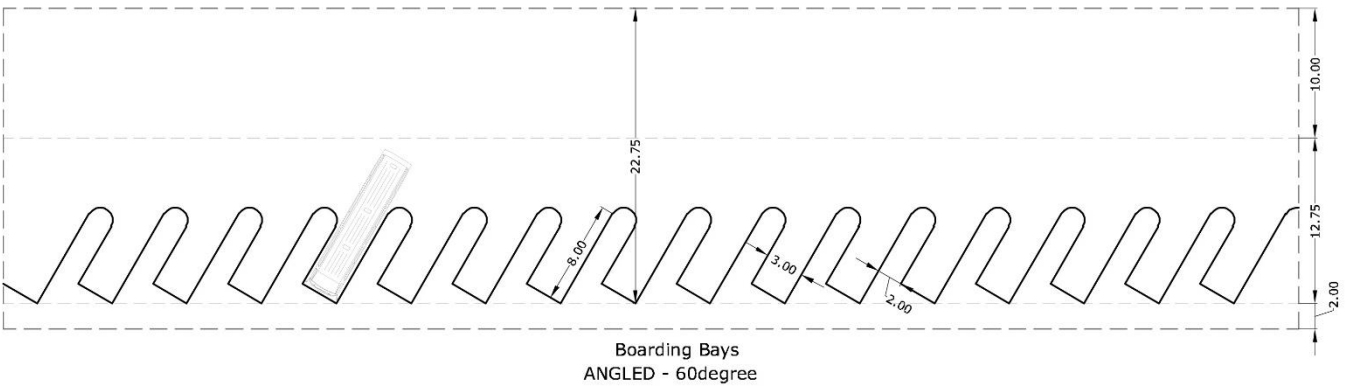
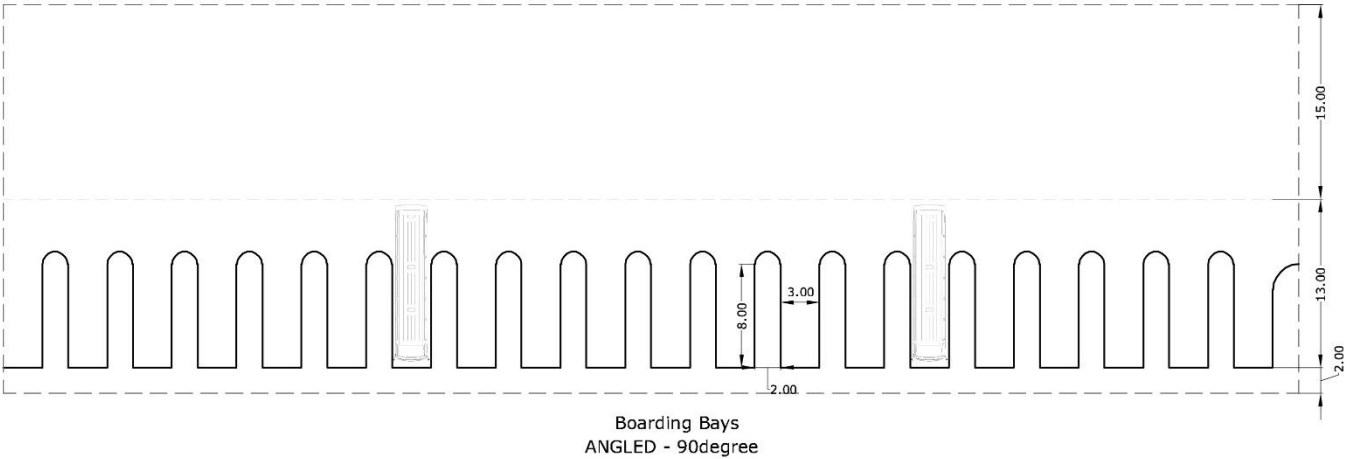

All Dimension are in Meters

03

- 30 degree Angular Bus Boarding Bay a
- Sawtooth Bus Boarding Bay b
- Parallel Bus Boarding Bay c

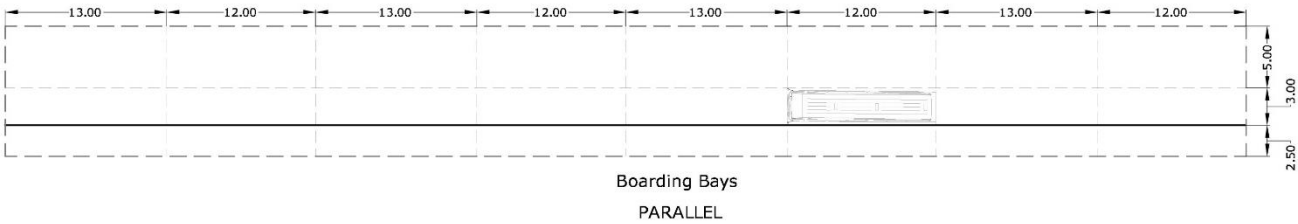
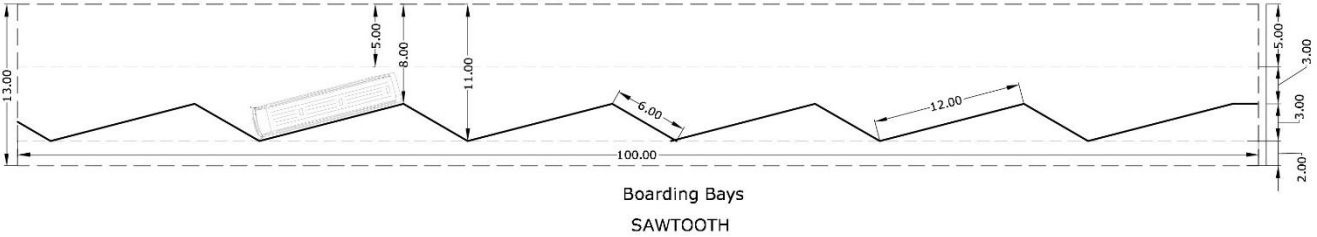
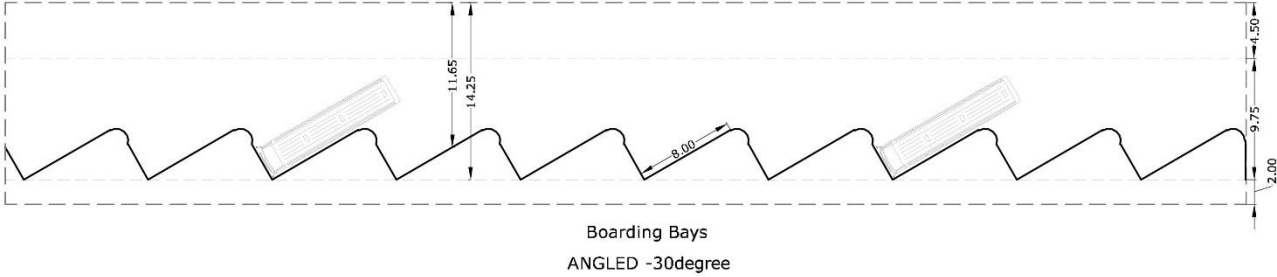

All Dimension are in Meters

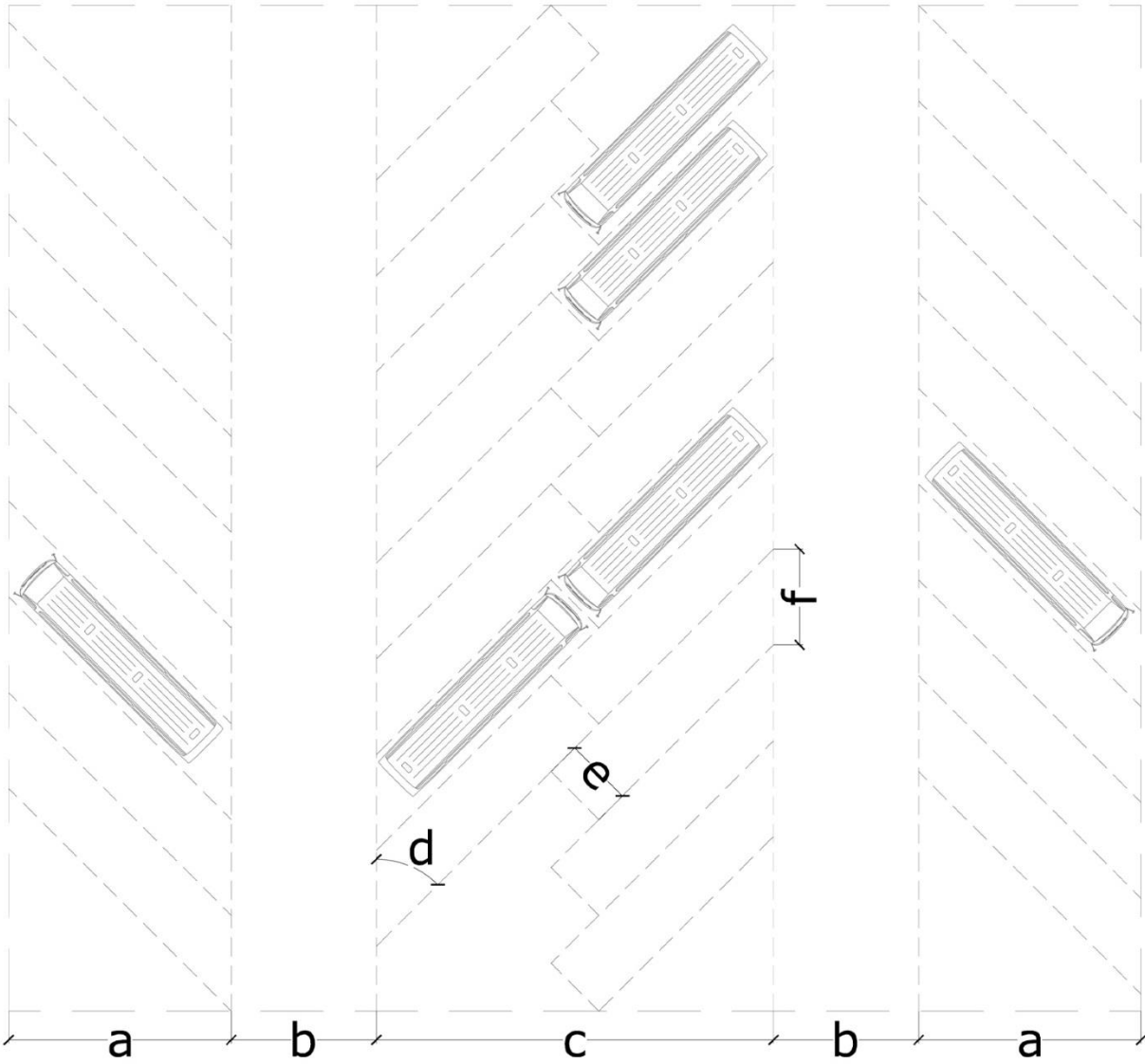

BUS PARKING STANDARDS - long term parking

	90	60	45	30
a	13	12.75	11.5	9.75
b	≥ 12	≥ 10	≥ 7.5	≥ 4.5
c	26	23.75	20.53	16.47
e	3.5	3.5	3.5	3.5
f	3.5	4.04	4.95	7

all dimensions in meters

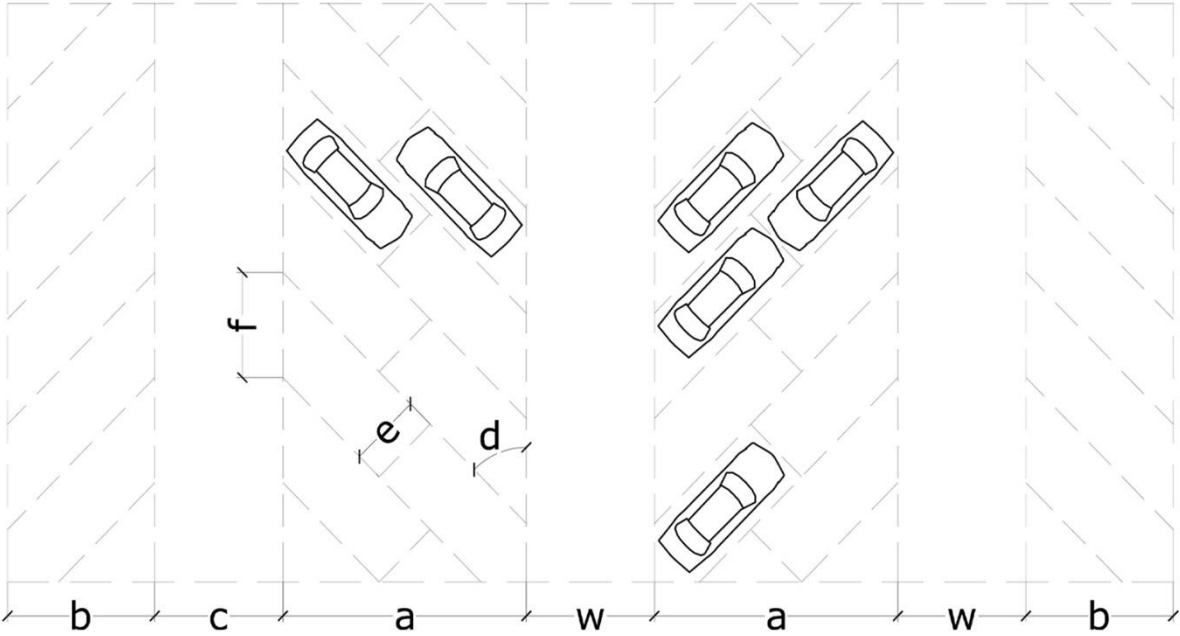

CAR PARKING STANDARDS - long term parking

	90	60	45	30
b	5	4.8	4.5	4
c	≥ 5	≥ 4.5	≥ 4	≥ 3.5
a	10	8.7	7.6	6.9
e	2.25	2.25	2.25	2.25
f	2.25	2.6	3.18	4.5

all dimensions in meters

Geometric Design Standards

A/B

Typology	Intercity/Local	A/B
----------	-----------------	-----

Idle Bus Parking Requirements

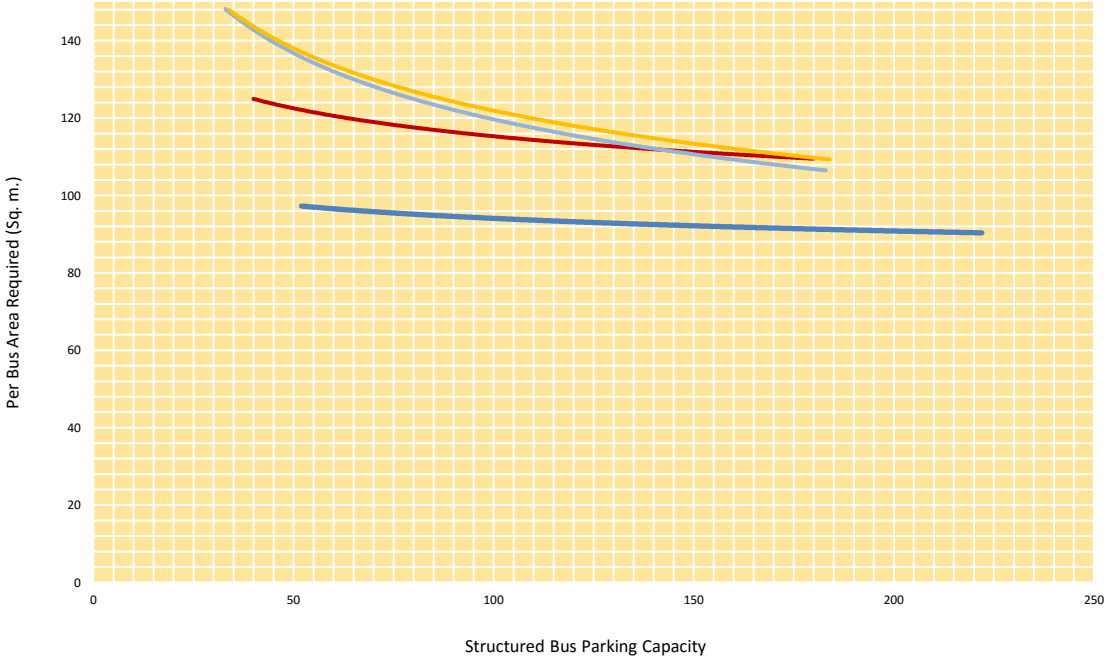

Per bus parking size represents floor area occupied per bus. For a three floor structured bus parking, to estimate ground coverage per bus, the floor area value may be divided by three.

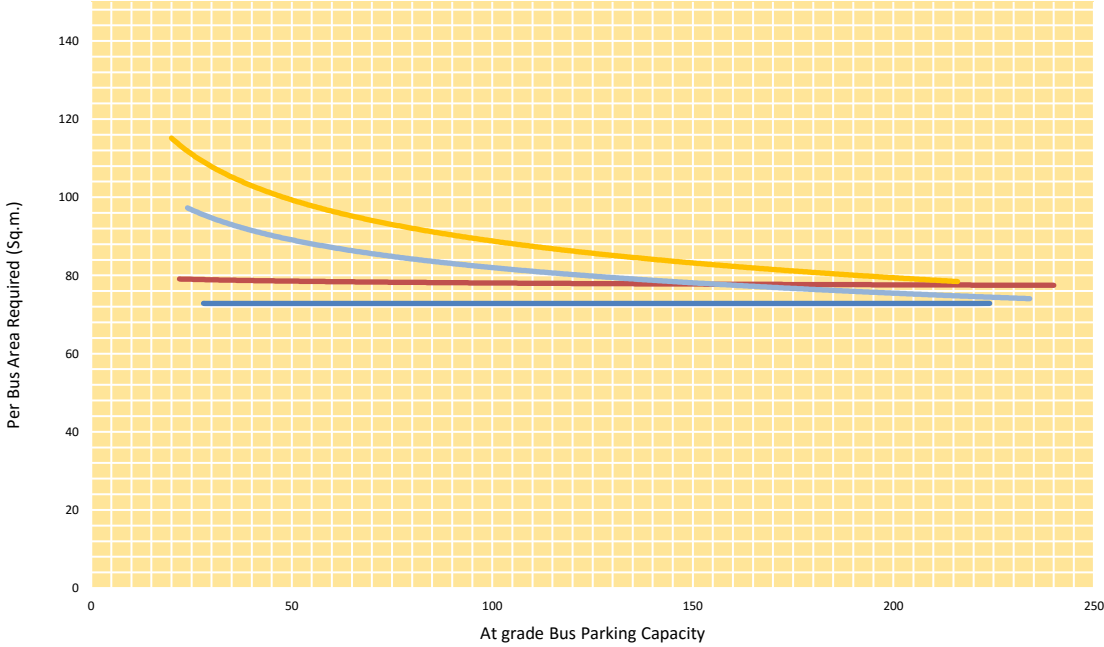

90 degree bus parking consumes least area per bus for any parking angle or size. For angled bus parking, 60 degree parking consumes the least space up to 400 bus parking size, beyond which 45 degree angle parking consumes lower per unit space per bus.

Idle bus parking (90degree) Idle Bus Parking (60 degree) Idle Bus Parking (45 degree) Idle bus parking (30 degree) Idle bus parking (15 degree)

Typology	Intercity/Local	A/B
----------	-----------------	-----

Car Parking Requirements

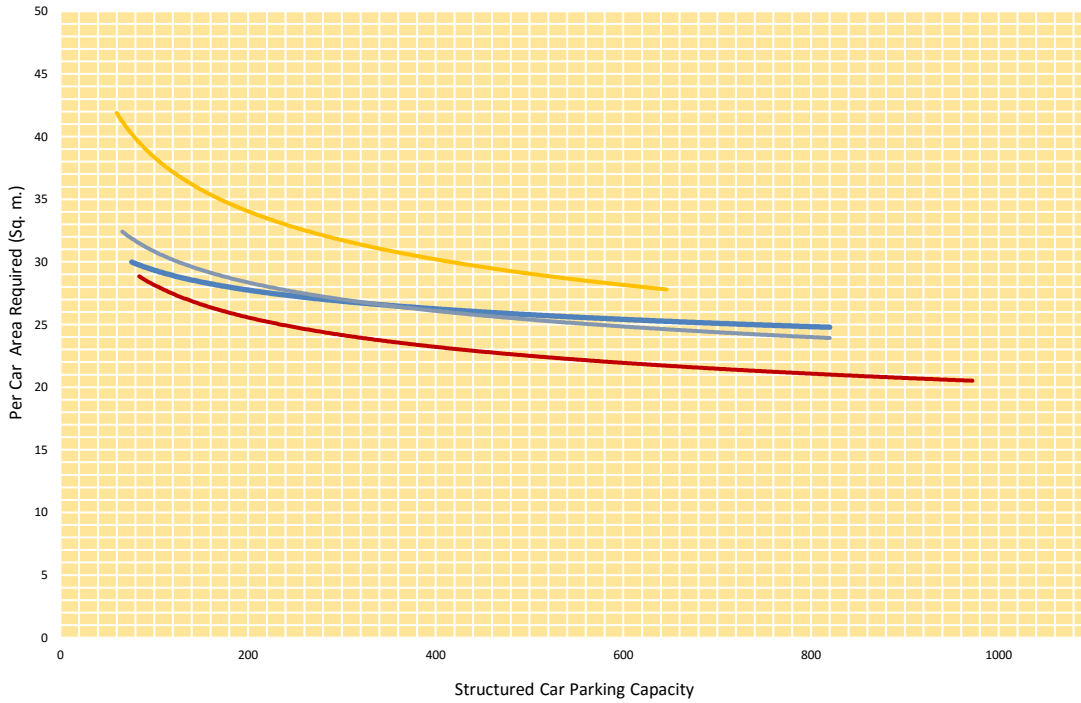

Per car parking size represents floor area occupied per car for a five floor multi level (with ramps and not mechanised) car parking. To estimate ground coverage per car, the floor area value may be divided by five.

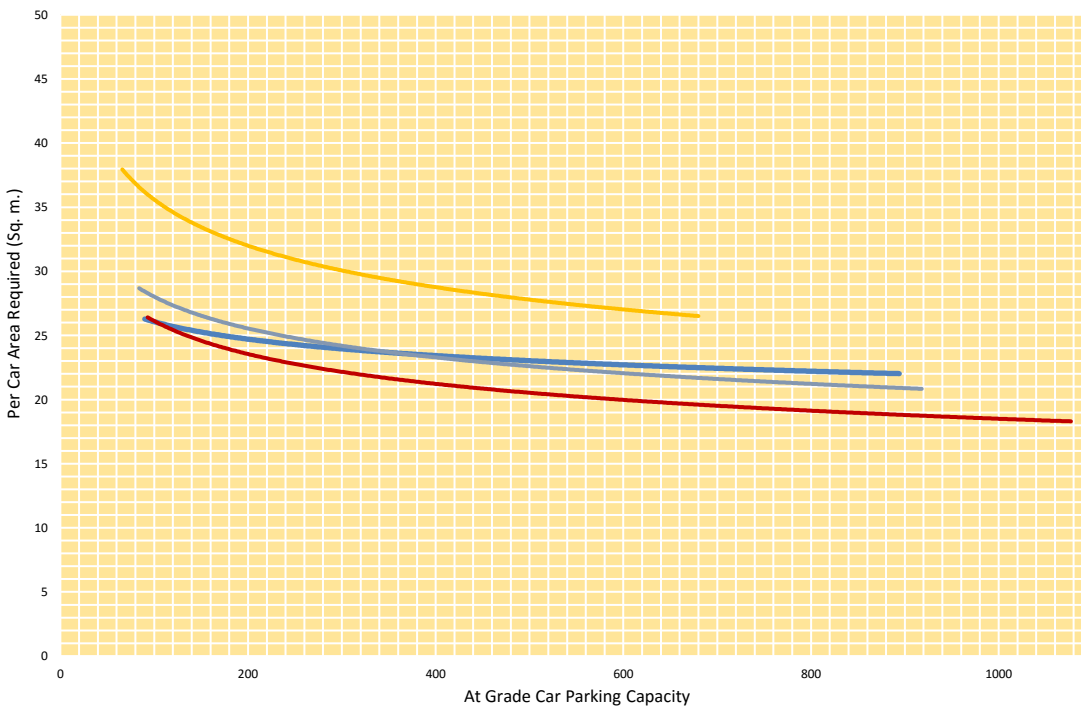

60 degree car parking consumes least area per car for car parking capacity higher than 40 in case of structured parking and higher than 80 in case of at grade parking.

Car parking (90 degree) █ Car Parking (60 degree) █ Car Parking (45 degree) █ Car parking (30 degree) █

4.2 Intelligent Transport Systems (ITS)

A bus terminal's function is to manage commuters and buses in a synchronized and organized manner, ensuring comfort, safety, and security of the terminal users (commuters, staff and operators). Terminals often fail at this, owing to lack of controlled information sharing, which causes anxiety and inconvenience among users. In India, terminals are plagued with problems like increased waiting time, uncertainty in bus arrival, and stacking of buses in the terminals. Bus schedule is often disturbed due to unpredictable factors like traffic conditions, weather situation, traffic jams, breakdowns etc. (Bangare et al. 2013). This leads to unreasonably long waiting time at the terminal, which compromises level of service to passengers, ultimately reducing the attractiveness of the facility.

Commuters at bus terminals need precise information regarding bus arrival and departure time. Terminals usually have fixed (official) bus timetables on websites or in print. But such timetables are usually static, offer limited information (operating hours, time intervals etc.), and are not updated regularly based on recent planned changes in schedule or day-to-day real-time traffic conditions. Apart from official timetables, public services like Google Maps provide bus related information to travelers (Bangare et al. 2013). Such services, though useful, fail to bridge the information gap. Additionally, commercial bus information providers offer real-time bus arrival information but charge substantially. Total capital cost for deployment of link infrastructure to deliver transit services is very high. If transferred to end users, it would lead to an increase in mobility expenditure for passengers.

ITS is a tested way to mitigate the above problems. Communication networks, digital mapping, video monitoring, sensors, real-time passenger information, and variable message signs are forging new trends in the public transport infrastructure field (Vanajakshi, Ramadurai & Anand 2010). Together they form ITS, which is increasingly being recognized the world over. Its main objective is to evaluate, analyses, and integrate new technologies (and concepts) to achieve efficiency, improve environmental quality, save energy, conserve time, and enhance safety and comfort (for commuters,

drivers and operators). ITS synergizes data acquisition, evaluation, analysis, and information dissemination, which helps develop an all-encompassing organization system for information sharing among operators and commuters. Thus, ITS can be understood as the use of modern technologies for improving transportation systems. Bus terminals are an essential part of the public transportation system and ITS plays a key role in delivering a 'quality' bus terminal facility. ITS implementation, specifically with real-time information system, ensures synchronized information distribution between commuters and operators. Recent modern bus terminals are embedded with ITS and real-time information system.

An interface between commuters and buses, the ITS architecture of bus terminals comprises two components - passenger information system (PIS) and bus information system (BIS). The architecture for these is presented in Figure 20 and the components briefly described in subsequent sub sections.

Passenger Information system/display (PIS/PIDS): It is an electronic information system which provides real-time passenger information. It may include both predictions about bus arrival and departure time, as well as information about the nature and causes of disruptions. PIS serves as a communication link between terminal operators and commuters (Trapeze 2015). With the help of passenger information technology, terminal authorities can communicate with passengers to provide them real-time bus location and status updates, schedule data, and timely announcements.

Bus Information system (BIS): It provides information required by bus staff i.e. drivers and conductors. It includes bus parking information, schedule of bus entry and exit in the terminal, route information, and trip information. BIS enables a bus driver to precisely allocate dispatching time (for the next trip) from the terminal, and get information on the bus bay allocated to her/him for boarding passengers (especially important in dynamic bay allocation type of bus terminal operations).

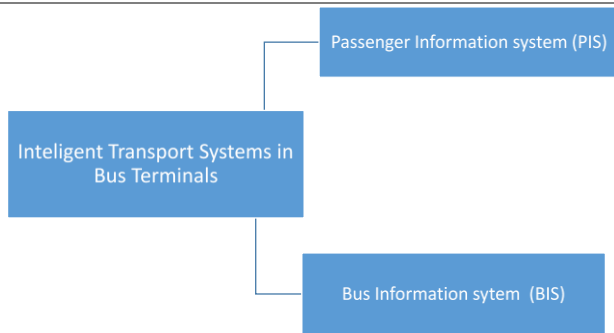

Figure 20: ITS architecture for Bus Terminals

Both PIS and BIS are largely based on the type of bus operations at a terminal complex (dynamic or fixed route bay). They help in solving operating problems, and in adopting appropriate new technologies to introduce innovations into terminal infrastructure. They ensure real-time arrival information for users, saving their time and improving the terminal's performance, along with helping improve overall system efficiency and increase service frequency.

Apart from the real-time information system, information can also be dispersed as static or planned information. Static or planned information changes slowly and is typically used for journey planning prior to departure. This type of information includes stations and stops, routes, service numbers, timings, trip durations, fares etc.

Static information is made available traditionally in printed form through route network maps, timetable booklets, name signs and/or pictograms at stations and stops etc. This information is also available through dedicated national and local telephone services. In many areas, static information is now being made available electronically through websites or over mobile phone services (typically via SMS). Information is also being increasingly provided in audio format, both on bus and within terminals. Public address systems, usually but not always automated, will typically give next service announcements at terminals and next stop announcement on-board buses (Passenger Information System 2015).

Benefits of ITS implementation in Bus Terminals

The goal of bus terminals is to provide efficient, reliable service to their users. For this, information about every

facility provided in terminals must be effectively distributed to the public. Implementation of ITS in the terminals has the following benefits:

- **Reduced perceived wait time:** The negative impact of terminal delays is minimized, leading to increased ridership numbers and the perception of better customer service. ITS is a boon for commuters who often suffer boredom/ anxiety not knowing when the bus will arrive.

- **Increased terminal efficiency:** Increased waiting time and uncertainty in bus arrival render the public transport system unattractive for passengers. Use of a variety of ITS technologies can track locations of buses in real time and predict when they will reach terminals along the route. This information when shared with passengers through PIS, will allow them to use their time efficiently and reach the terminal just before the bus arrives, or take alternate means of transport if the bus is delayed. Needless to say, use of ITS allows more efficient use of terminal space, with lesser crowding (of both passengers and vehicles).

- **Increased attractiveness:** Accurate and real-time travel information at bus terminals (and interchanges) make public transport an attractive and high-quality alternative to travelling by other modes. The accurate arrival time of the next bus will allow commuters to take alternative transport choices, and thus mitigate their anxiety and improve their experience.

- **Alerts and alarms:** Passengers and other terminal users can be alerted if the expected traffic is interrupted for a defined or undefined period of time, and also in case of any problems in terminal operations. ITS helps in warning commuters about emergencies such as strikes, terror threat, fire etc. This is an efficient way of aligning commuters' expectations with the service that the terminal system provides.

Information type

As terminal facilities continue to evolve, ITS is rapidly becoming a mainstay in today's public transport domain (Trapeze 2015). Integrated systems that keep passengers informed at the ends of, and along their journey, are increasingly in demand. Terminals must find a way to address this need as it vastly improves the

transit experience for commuters and streamlines operations for terminal employees. The information provided to terminal users by ITS integration depends on the location (Passenger Information System 2015) where the information is needed to be disseminated. The information distribution framework can be broadly divided into two contexts - off board information and on board information.

Off board information: Off board information is provided to passengers at the terminal. Usual up to date predictions provided include (Passenger Information System 2015):

- Which route is operated by the next bus to arrive, including its expected departure time and destination.
- When the bus will arrive.
- How closely is it running to its schedule.
- Similar information for the subsequent few services
- General advice (on current travel disruptions) that may be useful to the passenger in understanding the implications for their travel plans

On board Information: On board information is provided to passengers after boarding the bus. This includes (Passenger Information System 2015):

- What is the next station or stop.
- When is the expected time of arrival at the next station or stop.
- How closely is the bus running to its schedule.
- Advice on connecting services.

ITS information medium implemented in bus terminals

ITS applications require both power and communication infrastructure. It can significantly improve the usability of terminal as well as the overall feeling of safety and security. Potential ITS applications that may be applied in bus terminals are as follows (Pace Suburban Bus 2015):

1. Real-time arrival information.
2. Electronic schedules and route information.
3. Interactive information displays.
4. Payment and smart card payment kiosks.
5. Audible signage.

6. Wireless connectivity for arrival and scheduling information.
7. Cameras and emergency call stations.
8. Electronic driver-to-waiting passenger communication.

In recent years, new electronic technology has been developed to provide improved traveler information. Information may be delivered via any electronic media, including:

- Telephone (either a manned bureau service or an automated answering system).
- Touch screen kiosks for self-service (e.g. in customer offices).
- Internet through a website.
- PDA or mobile phone (typically using SMS or WAP).
- LED displays and screens inside terminals

ITS implementation considerations in bus terminals

ITS functionality should be considered as an integral component in developing modern terminal facilities. It is essential for convenient public information distribution, operational efficiency, and security. Following are some ITS concerns to be considered in terminal design and planning:

1. As bus terminals are a part of public infrastructure, ITS facilities should be implemented considering usability by physically challenged travelers (visual or hearing impaired). Thus, information distribution should comprise visual, voice, or touchable media (Passenger Information System 2015).
2. Considering language diversity in India, the ITS installed in the terminal should provide information in multiple languages (Passenger Information System 2015).
3. Video cameras should be used at strategic terminal locations to allow the terminal staff to monitor conditions and events in the station, and to record them for law enforcement purposes. The presence of video cameras and call boxes also acts as deterrent for crimes.
4. ITS hardware and connection points are typically located in a control room within the terminal facility. The control room should be located in 'discreet access area' to the terminal, and signed as 'staff only'.

5. Management needs for including the ITS facility should feature in the operational planning process of the terminal.

4.3 Services

The design and provision of services—such as lighting, drainage, firefighting, and information systems—is an essential component of bus terminal design. Without these services well integrated into the design, a terminal is unlikely to meet its requirement, and the target level of service. Some essential services to be integrated into bus terminal planning and design have been discussed below.

4.3.1 Lighting

Bus terminals are among those public infrastructural facilities that usually operate almost 24 hours a day. Bus terminal operations continue beyond sunset (particularly in India), necessitating lighting provisions. But lighting is also required during the day, because of solid roofing in the terminal buildings, owing to which the environment inside becomes dark and discomforting (Campbell & Smith 2008). Lighting plays a key role in enhancing terminal facilities - through ambient illumination in order to allow a safe, comfortable, and functional environment, and to highlight key architectural aspects to create an iconic and attractive bus terminal (Trans Link Transit Authority 2011).

Bus terminal lighting is designed to meet the specific needs of commuters using the terminal facility and other transit areas (parking, walkways, internal or underground areas, bus stops, and shelters). The main objective is to provide passengers a sense of personal security (APTA 2009). Appropriate lighting provisions help passengers to see (and approach) the designated transit areas (and other passenger amenities) within the terminal. According to the Trans Link Transit Authority (2011), lighting features are integral components of Crime Prevention through Environmental Design (CPTED) methods. CPTED suggests that proper illumination discourages loitering (or unintended uses) of terminal facilities by non-bus riders (Transportation Research Board 1996). Adequate lighting in the terminal aids operators in proper management of bus operations. Further, it helps bus drivers identify waiting passengers and possible obstructions in the bus areas (boarding bays, unloading bays, and idle bus parking areas), especially during night hours.

The following section presents the types of bus terminal lighting, with details on their usability areas, specific to the different functions performed in the terminal.

Types of lighting

Three types of lighting are used in terminals (APTA 2009a): These are:

a) Continuous lighting:

This is the most common type of security lighting system installed in bus terminals. It consists of a series of fixed lights arranged continuously, to light interior or exterior areas during hours of darkness. They can be used around a building perimeter, pedestrian pathways, vehicle approaches, or property boundaries (APTA 2009a).

b) Standby lighting:

This lighting type is similar to continuous lighting, in layout and design, except that the luminaries are not continuously lit. Instead, they are turned on either automatically (when activity is detected in the area) or manually. Standby lighting should use instant ‘on’ lighting lamps (e.g. incandescent, halogen, fluorescent, inductively coupled, or LED) (APTA 2009).

c) Mobile lighting:

This lighting type is manually operated and moveable. Mobile lighting may supplement continuous or standby lighting. It can be used at special events and in emergencies, during hours of darkness (APTA 2009).

Table 2 classifies terminal lighting types according to their usability areas.

Table 2: Application of lighting in a bus terminal

Location Of Use	Types of Lighting		
	Continuous	Standby	Mobile
Critical infrastructure access point		X	
Fare gate	X		
Kiosk	X		
Parking lot open area	X		X
Waiting area	X		
Parking structure roof	X		
Platform (outside canopy)	X		
Platform (inside canopy)	X		
Pedestrian pathway	X		X

Restricted area entry / Exit		X	
Station entry/exit	X		X
Ticket vending machine	X		
Vehicle kiss and ride approach	X		
Vehicle staging area	X		X

Bus terminal lighting performs functions related to night time safety, security, orientation, and the illumination of features. To fulfil this responsibility, lighting systems must provide a level (and type) of lighting that is consistent with the requirement of individual functions (and activities). Higher lighting levels should be considered for critical functions and areas. Table 3 presents the desired lux-levels⁴¹ for different terminal functions.

Table 3: Required lux levels according to the functions in a bus terminal (Source: Labour and Welfare Bureau of the Government of the Hong Kong Special Administrative Region)

S. No.	Function	Lux Level
1.	Waiting Rooms	150
2.	Ticket counters	1000 (min 500)
3.	Accounting Office	1000 (min 500)
4.	Office in general	500 (min 250)
5.	Canteen	150
6.	Platforms/Concourse	150
7.	Ground floor Entrance Lobby and Lift	120
8.	Lift Lobby of Upper Floors	85
9.	Small Items Storage	300
10.	Food Preparation and Cooking	500
11.	Bars, Dining Rooms	50-200
12.	Toilets/corridors/Stairs	150
13.	Sign Surface	120
14.	Canopied Areas	150
15.	Parking Bays and Driving Lanes	75
16.	Site Entrance and Exits	250-300
17.	Garage (General lighting)	500 (min 200)
18.	Washing Area	500 (min 250)
19.	Parking lot	150

⁴¹ Lux-levels: Lighting requirement in any infrastructure is measured in lux levels. Lux is a quantitative measure of the ability of a light; it is the metric standard unit of measure for illuminance.

Lighting Recommendations

The placement and maintenance of lighting in the bus terminal is normally the responsibility of local jurisdiction or the terminal developer (such as the concerned STU). Lighting levels must meet the current regulation standards for public transport facilities and signage. Local municipalities establish lighting standards for their jurisdictions (Pace Suburban Bus 2015). Therefore, the lighting for terminal development must be planned in coordination with appropriate municipalities.

Since bus terminals are a subject of public interest, the decision to install lighting at a terminal site is influenced by cost, availability of power (electricity), and vandalism (Transportation Research Board 1996). It is important therefore that lighting elements are maintained regularly and are resistant to vandalism. Lighting can be expensive to install, but is indispensable to passenger safety. To counter prohibitive costs that make it uneconomical to provide lighting at terminal sites, transit agencies can include installation of lighting as a part of the agreement with advertising companies. This cost effective approach includes not just installation by the advertising company, but also maintenance. During daylight, the use of translucent materials—and structures—which emulate an open and spacious design, helps achieve a more naturally lit terminal environment, and economic lighting provisions (Trans Link Transit Authority 2011).

4.3.2 Drainage

Waterlogging and ponding is a major problem in most Indian bus terminals. Needless to say, it impacts terminal performance. It causes inconvenience to commuters, contributing to the terminal becoming unattractive and generates additional expenses in terms of higher maintenance cost. Its main cause is the terminal planner's apathy for drainage/sewage considerations. Therefore, the guideline advocates provision of adequate arrangements for drainage of all sewage and waste water in terminals. Terminal planning should incorporate the necessary profile design of large open spaces, in order to avoid accumulation of water and ensure rapid drainage, even during peak rainfall events.

The terminal should be planned in a way that major interface zones between commuters and buses are kept away from drainage facilities; e.g. the bus bay areas (especially unloading and boarding) should not be over (or near) catch basins, as this creates a potential tripping hazard.

Additionally, boarding and off-boarding areas should be adequately sloped, to drain water from the passenger-bus interfaces. This water should then be directed to drainage channels provided in the system, such as natural earth swales, concrete gutters, or ditches. These channels should be located (and shaped) to minimize the potential for traffic hazards, and to accommodate the anticipated storm-water flows. The drainage in bus terminals should be designed to cause no stagnation at the maximum discharge rate for which the different units are designed. According to the Washington Metropolitan Area Transit Authority 2009, passenger boarding areas should be designed with minimum slope gradient of 1:50 (2%) for drainage.

The guideline also suggests that proper drainage inlets should be positioned suitably to prevent ponding, and to limit the spread of water to critical areas (where commuters alight and board). The drainage inlets are often covered with slotted gratings. These should be aligned perpendicular to passenger path, to prevent their hindering commuter movement, especially for people with baggage trolleys, prams, and walking aids.

4.3.3 Fire Fighting

Every public space, institution or building should be constructed, equipped, maintained and operated in fulfilment of the need to avoid undue danger to the life and safety of occupants from fire, smoke, fumes, or panic, during the time period necessary for escape. Planning for fire protection in/around bus terminal facilities involves adopting an integrated systems approach which allows analysing all the terminal components as a comprehensive fire safety system package (WBDG Secure/Safe Committee 2014). Such analysis requires more than code compliance, or meeting the minimum legal responsibilities for protecting the terminal facility from fire disaster. Therefore, code requirements must be creatively (and efficiently) integrated with other fire safety measures and design strategies, so as to achieve a balanced design that will

provide desired levels of safety (evacuation, recovery and egress).

For terminal development in India, Part-IV (Fire and Life Safety) of National Building Code of India should be followed, unless otherwise specified. However, additional state and city level building codes and fire codes are available across the nation and may also be referred to. Thus, terminals should be planned, designed and constructed, in consultation with the appropriate government agencies. In case of non-government projects (such as those developed by concessionaires under PPP), the appropriate building code and fire code official should be consulted, for minimum and recommended fire safety measures (WBDG Secure/Safe Committee 2014). To ensure fire safety, the terminal building schemes shall also be cleared by the Chief Fire Officer. Additionally, fire protection engineers must be involved in all aspects of the design, to ensure a reasonable degree of protection of human life from fire (and combustion products), as well as to reduce the potential loss from fire (real and personal property, information, organizational operations).

Terminal projects need to be designed to incorporate efficient and cost-effective fire protection systems, both passive and automatic. These systems are effective in detecting, containing, and controlling and/or extinguishing a fire event at early stages. Some of these firefighting systems are listed below:

1. Wet riser
2. Hose reel
3. Automatic sprinkler system
4. Fire hydrant
5. under ground water tank with draw off connection
6. Terrace water tanks
7. Fire pump
8. Terrace pump
9. First aid firefighting appliances
10. Auto detection system
11. Manually operated electrical fire alarm system
12. Public assistance system with talk back facility
13. Emergency lights
14. Auto D.G. set
15. Illuminated exit sign
16. Means of escape, or fire exits

17. Miniature Circuit Breaker(MCB)/ Earth leakage circuit breaker(ELCB)
18. Fireman switch in lift
19. Hose boxes with delivery hoses and ranch
20. Pipes refuge area

As per National Building Organisation code (NBO-2011), the mentioned fire safety arrangements should be provided in bus terminals (Bhubaneswar Development Authority 2008).

4.4 Typical Details

To implement proposed designs at the terminal site, detailing them is important. Detailing yields a set of drawings referred to as construction drawings. These assist in implementing specific planning details on site. This section presents drawings for some of the critical details that should be part of a bus terminal's design drawings. These include -

- Feeder mode bay details
- Footpath details
- Tactile details
- Raised crossing details
- Bollard details
- No-entry signage details
- Drop-off lane signage details
- Feeder mode parking signage details
- Parking signage details

Feeder Mode Bay Detail a

300 x 300mm and 60mm thick steam cured PCC dotted tack tile, manufactured by using M-30 grade of concrete and with top surface in Yellow colour and manufactured by vibro compaction process and using jointless FRP moulds, so as to achieve shuttering finish, as per specifications.

150 x 300mm and 60mm thick machine moulded steam cured cement concrete slabs for paving made as per approved design and pattern complete using M-30 grade of concrete and suitably reinforced and manufactured by vibro compaction process as per specifications.

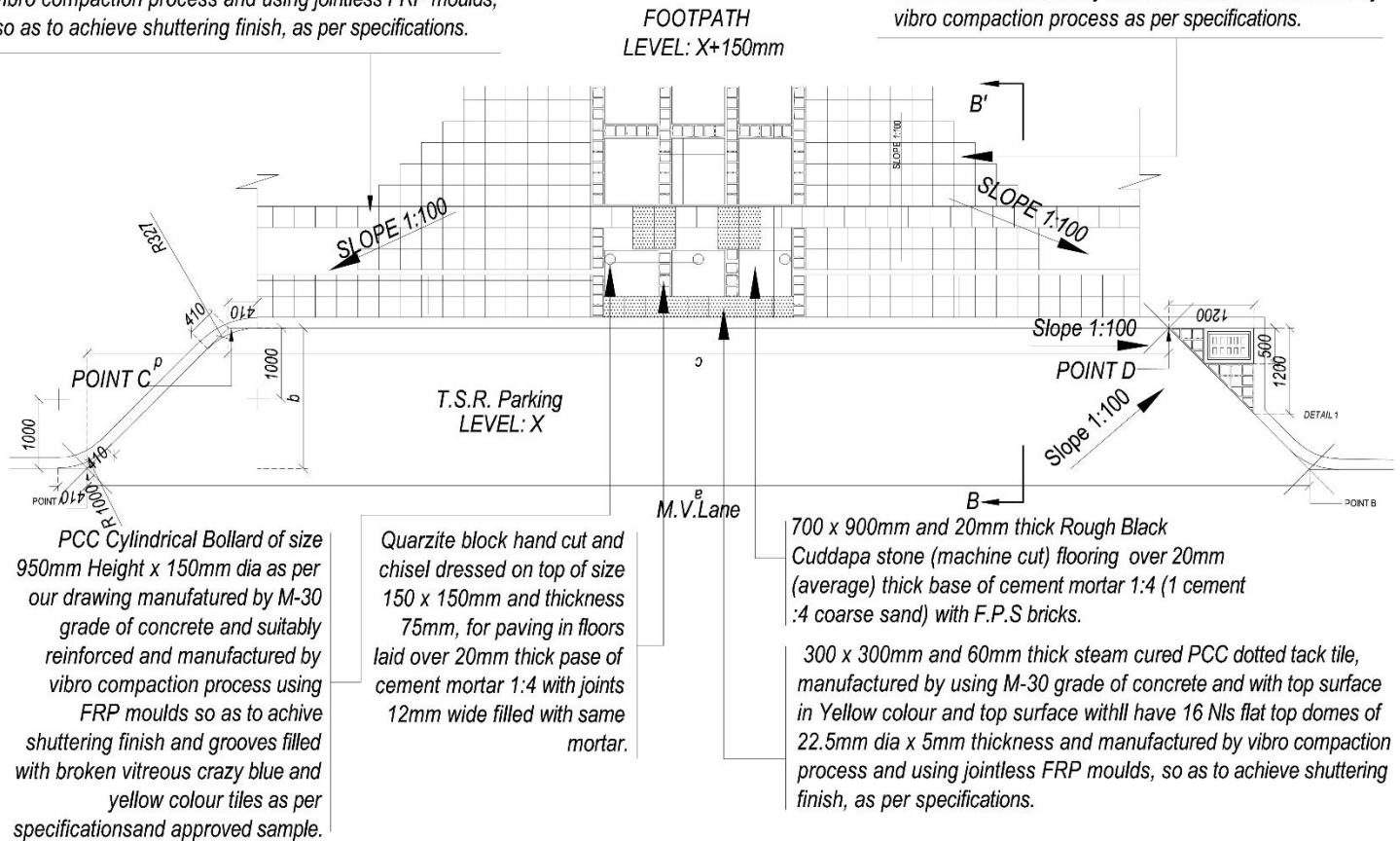

PCC Cylindrical Bollard of size 950mm Height x 150mm dia as per our drawing manufactured by M-30 grade of concrete and suitably reinforced and manufactured by vibro compaction process using FRP moulds so as to achieve shuttering finish and grooves filled with broken vitreous crazy blue and yellow colour tiles as per specifications and approved sample.

Quartzite block hand cut and chisel dressed on top of size 150 x 150mm and thickness 75mm, for paving in floors laid over 20mm thick base of cement mortar 1:4 with joints 12mm wide filled with same mortar.

700 x 900mm and 20mm thick Rough Black Cuddapa stone (machine cut) flooring over 20mm (average) thick base of cement mortar 1:4 (1 cement :4 coarse sand) with F.P.S bricks.

300 x 300mm and 60mm thick steam cured PCC dotted tack tile, manufactured by using M-30 grade of concrete and with top surface in Yellow colour and top surface with 16 NIs flat top domes of 22.5mm dia x 5mm thickness and manufactured by vibro compaction process and using jointless FRP moulds, so as to achieve shuttering finish, as per specifications.

ALL DIMENSIONS ARE TO BE READ & NOT MEASURED						
DIMENSIONS TO BE REFERRED FROM PLAN :						
a	b	Lx	POINT A	POINT B	POINT C	POINT D
NOTES :						
d=b			x = Level of M.V. Lane			
c=a-2d						
'c' is the distance between Point C and Point D						
'a' is the distance between Point A and Point B						
'b' is the vertical distance between Point A and Point C						
'd' is the horizontal distance between Point A and Point C						

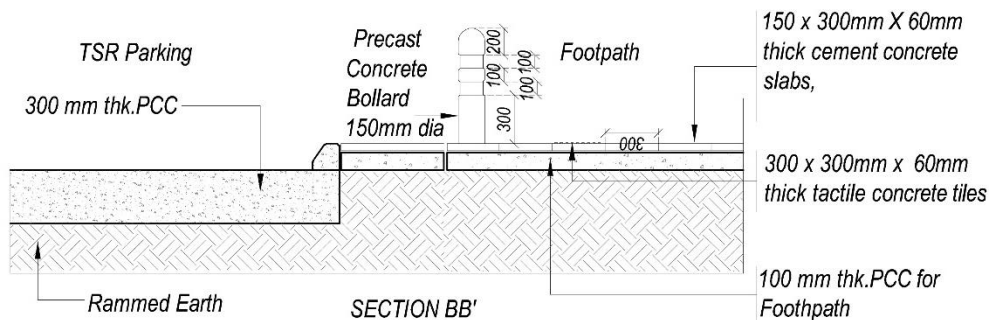

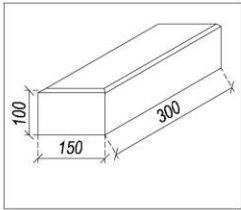
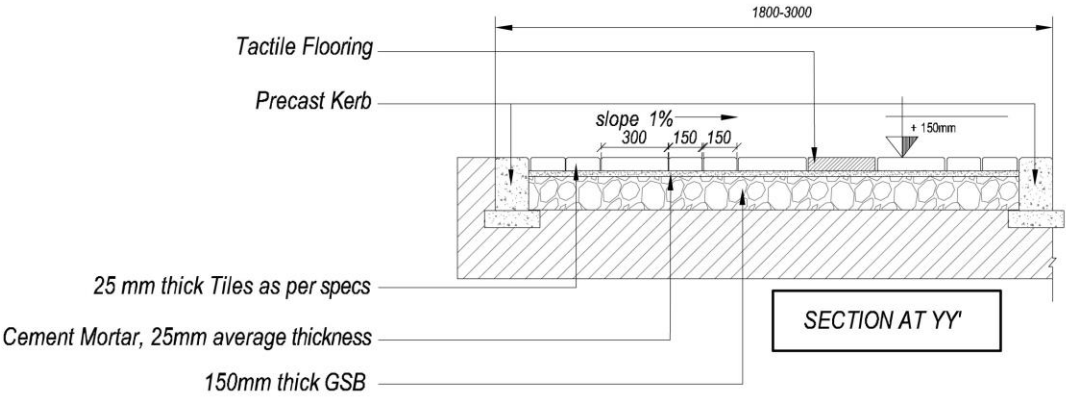
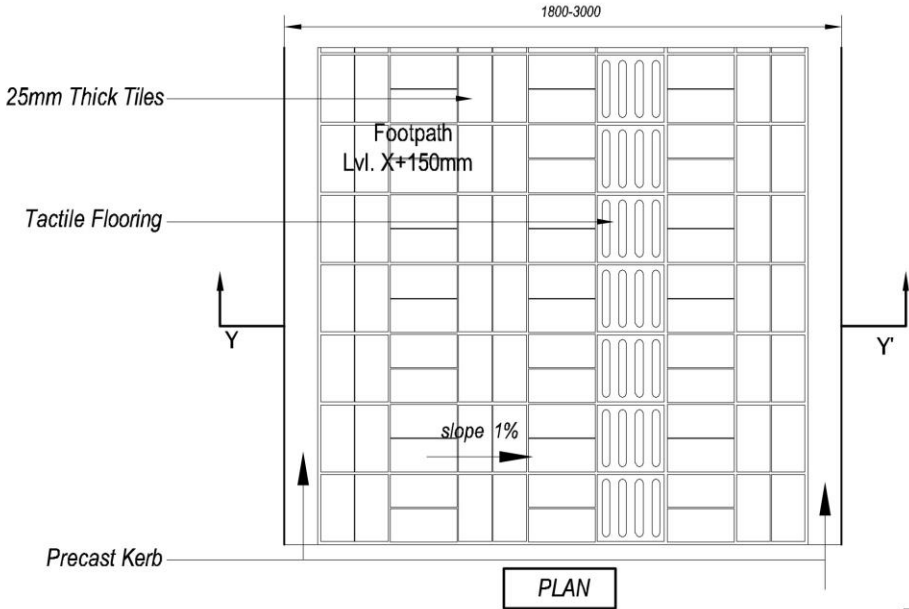

Paving Block (150 x 300 x 100) used on footpaths where there is also a movement of vehicles.

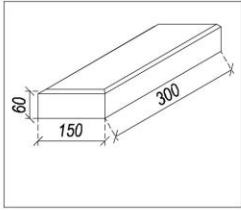
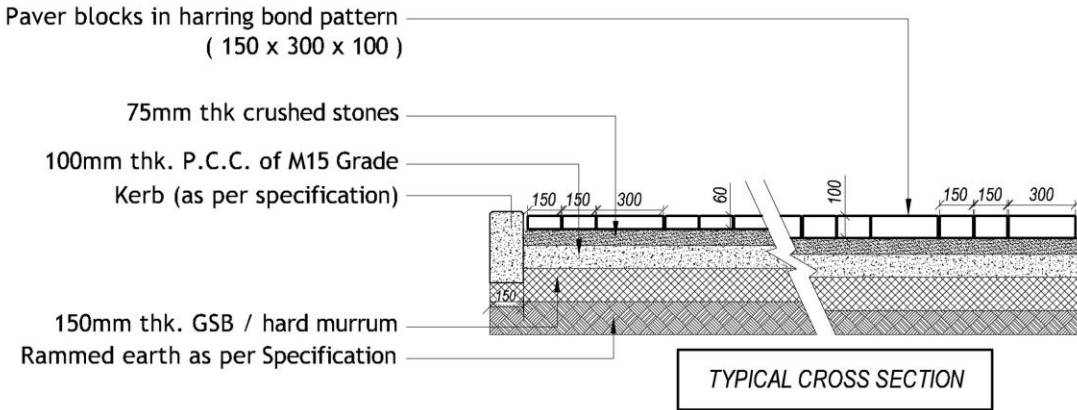

Paving Block (150 x 300 x 60) used on footpaths and other pedestrian path as specified by design.

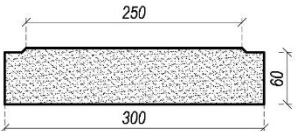
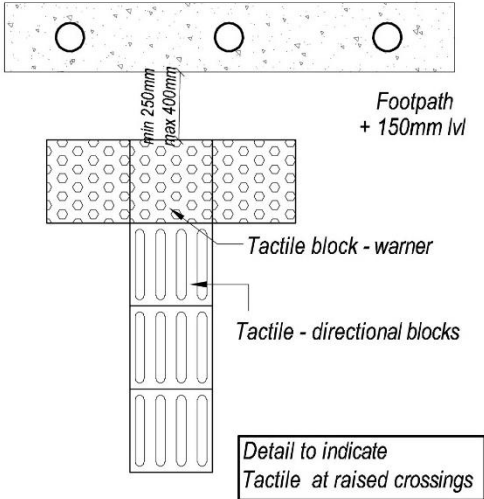
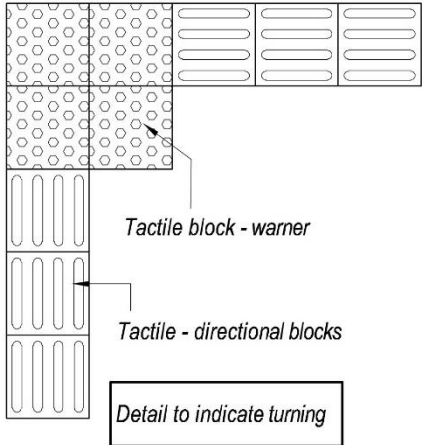

Section AA

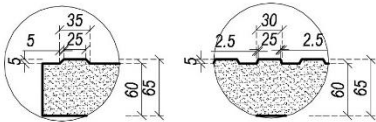

Detail X

Detail Y

Refer Detail X



Section BB

Refer Detail Y

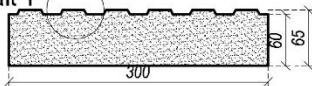

Section BB

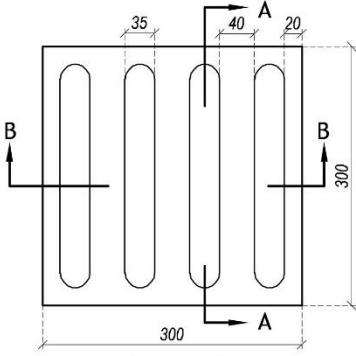

Plan

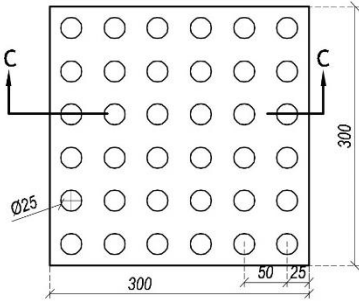

Plan

Detail of Precast 'Directional' Tactile Concrete Paver

Detail of Precast 'Warner' Tactile Concrete Paver

NOTE: Tiles to be made in yellow color as per specification and by design

Tactile Flooring – Tree Guard Detail
Tactile Flooring – Manhole Detail

a
b

150mm x 300mm and 60mm thick machine moulded steam cured cement concrete slabs for paving made as per approved design and pattern complete using M-30 grade of concrete and suitably reinforced and manufactured by vibro compaction process as per specifications.

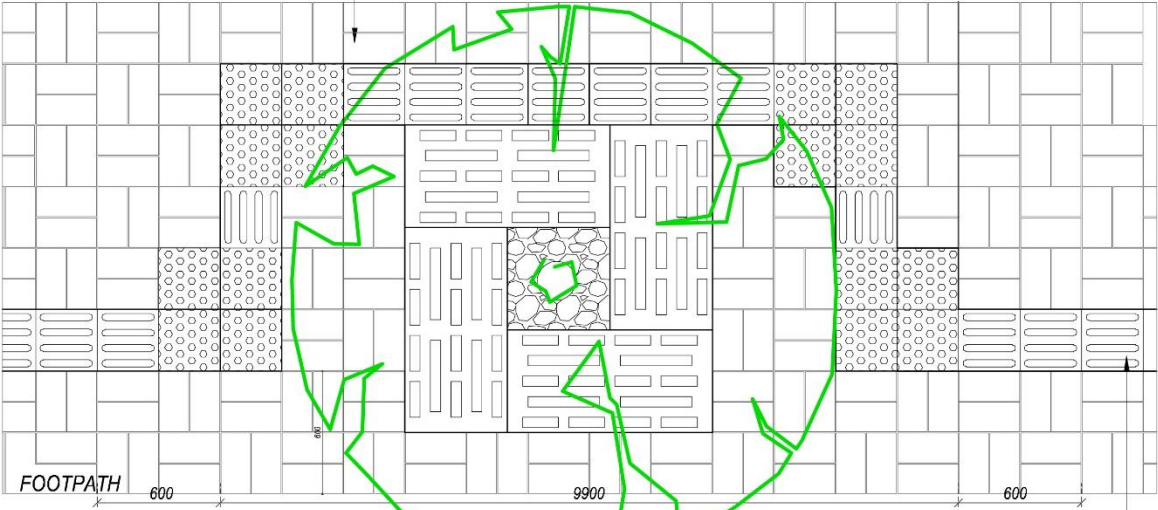

300 x 300mm and 60mm thick steam cured PCC directional blocks, manufactured by using M-30 grade of concrete and with top surface in Yellow colour and manufactured by vibro compaction process and using jointless FRP moulds, so as to achieve shuttering finish.

TACTILE WITH TREE GUARD

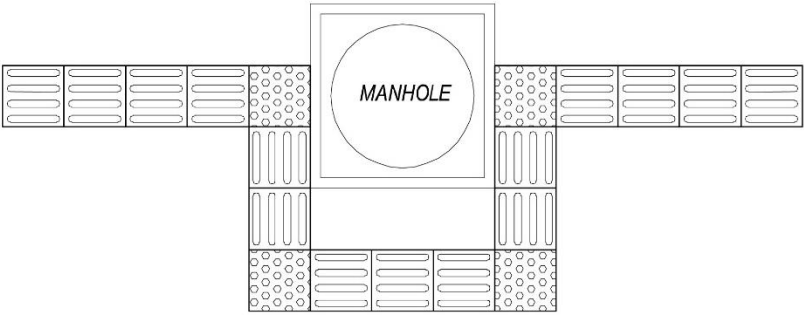

TACTILE AROUND MANHOLE

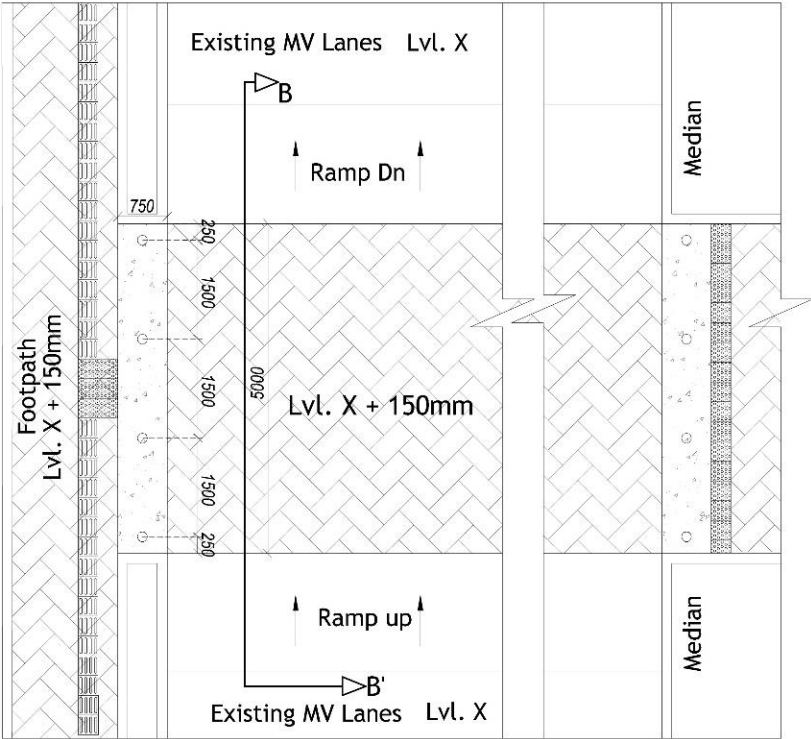

PLAN

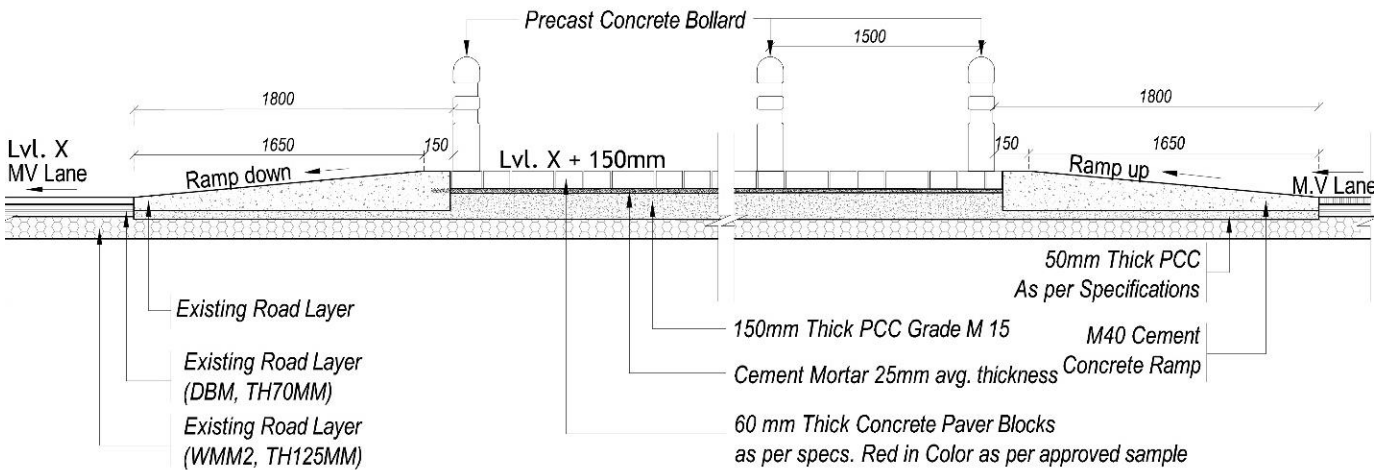

SECTION AT BB'

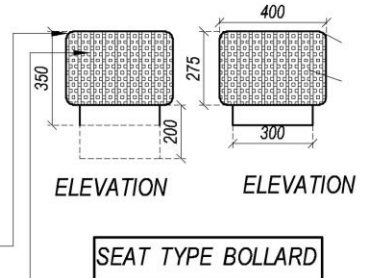
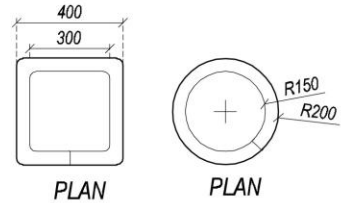
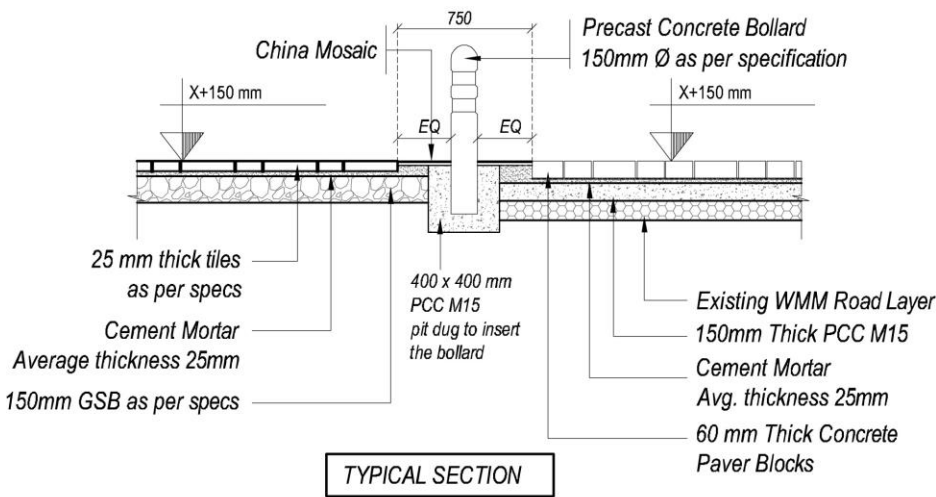
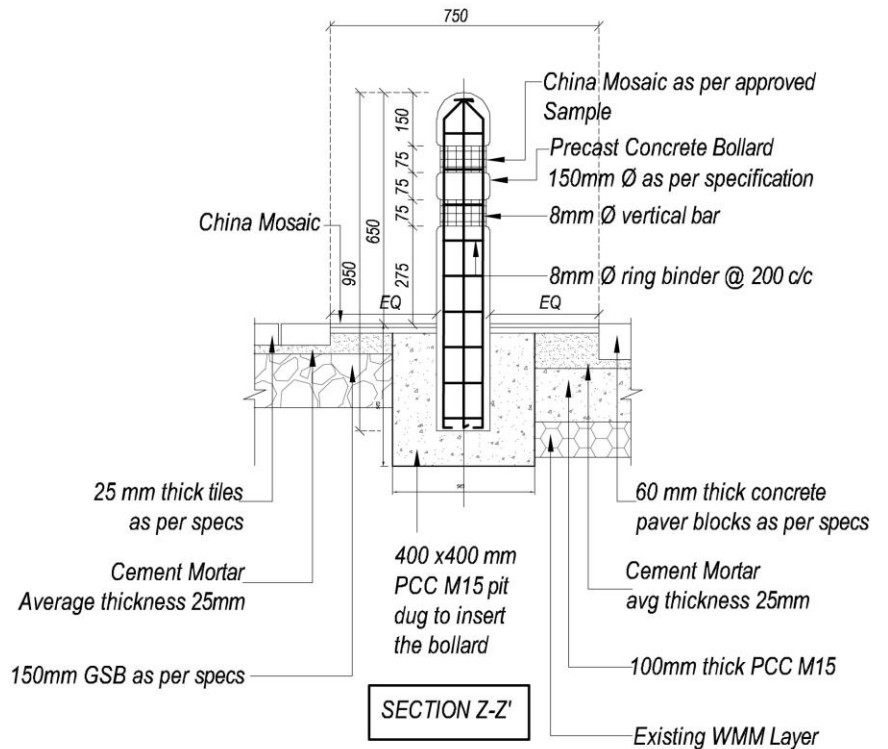

Edges rounded to prevent people hurting themselves and also to prevent chipping
Grit finish with grey and white colour dana with nominal danasize between 6mm and 8mm

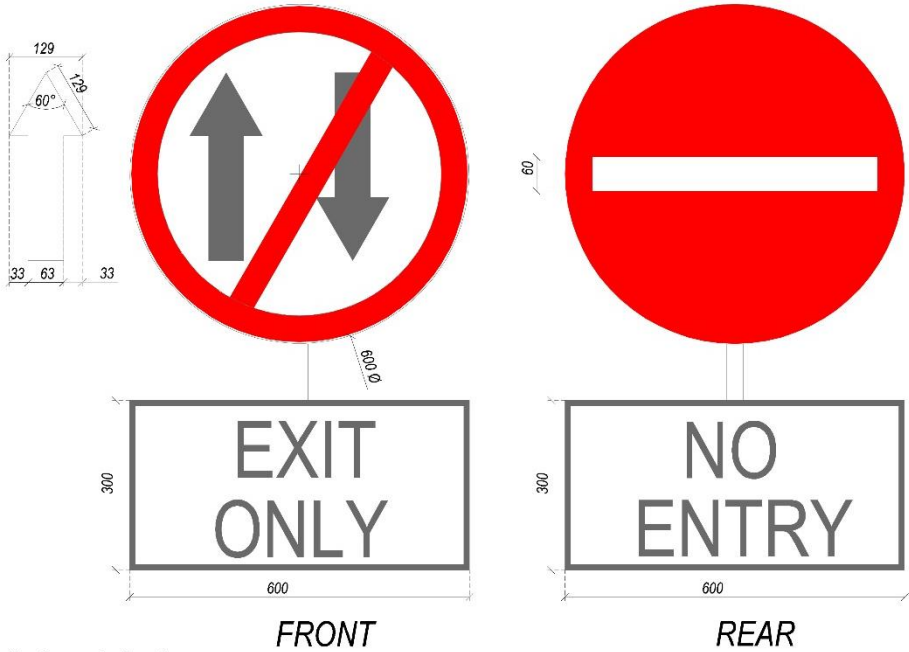

mounting type : single pole
 clear mounting height : 3500mm
 top :
 size : 600mm (diameter)
 border : red (retroreflective)
 text : black

bottom:
 size : 600mm x 300mm
 background - white (retroreflective)
 text - black
 text height - 100mm

REGULATORY SIGN :
 EXIT ONLY WITH NO ENTRY AT REAR

NOTE:
 ALL DIM. TO BE READ AND NOT MEASURED

ENTRY INTO DROP OFF LANES

MOUNTING TYPE : SINGLE POLE
CLEAR MOUNTING HEIGHT : 3000mm

from top :

no parking
size : 600mm (diameter)
border : red (retroreflective)
text : black

board size : 600mm x 300mm
text : black
text height : 60mm

informatory - board 1- left
size : 600mm x 900mm

top - 600mm x 750mm
background - blue (retroreflective)
symbol (bus) - white
text - white
text height - 100mm

bottom - 600mm x 150mm
background - white (retroreflective)
symbol (arrow) - black

informatory - board 2 - right
size : 600mm x 900mm

top - 600mm x 600mm
background - blue (retroreflective)
symbol (bus) - white
text - white
text height - 100mm

bottom - 600mm x 300mm
background - white (retroreflective)
symbol (arrow) - black

NOTE:
ALL DIM. TO BE READ AND NOT MEASURED



Drop –Off lane Signage Detail a



REGULATORY SIGN :
DROP OFF LANES

mounting type : single pole
clear mounting height : 2100mm

top :
size : 600mm (diameter)
border : red (retroreflective)
text : black

bottom:
size : 600mm x 300mm
background - white (retroreflective)
text - black
text height - 60mm

NOTE:
ALL DIM. TO BE READ AND NOT MEASURED

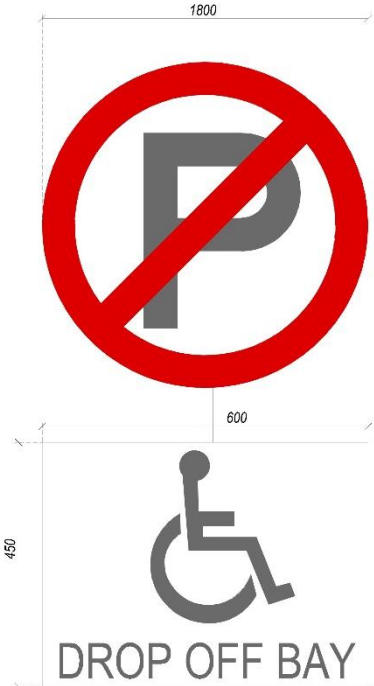

DESIGNATED DROP OFF BAY FOR ACCESSIBLE /
DIFFERENTLY ABLED

mounting type : single pole
clear mounting height : 2100mm

top :
size : 600mm (diameter)
border : red (retroreflective)
text : black

bottom:
size : 600mm x 450mm
background - white (retroreflective)
text - black
text height - 60mm
symbol - black

- Feeder Mode Parking Signage Detail a
- Vehicular Parking Signage Detail b
- Pedestrian Crossing Signage Detail c

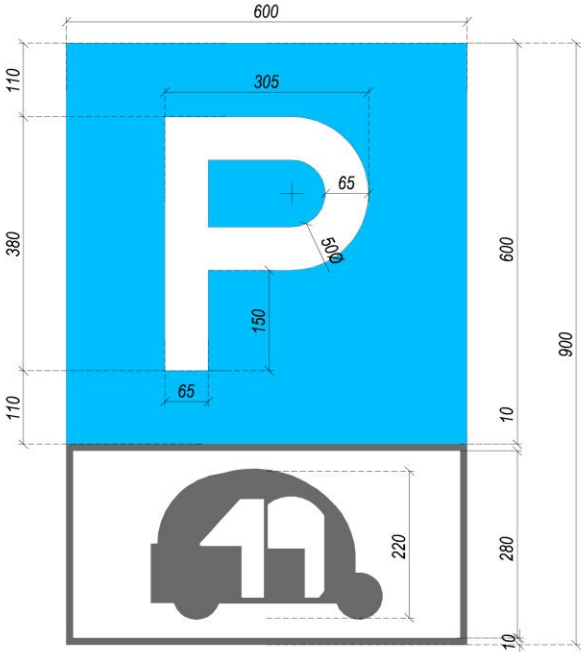

AUTO RICKSHAW PARKING

Nomenclature: (SB1)

Mounting type : centre of the post
clear mounting height : 2500mm

Top: background - blue (retroreflective) text - white (retroreflective)

Bottom: background - white (retroreflective) tsr legend - black

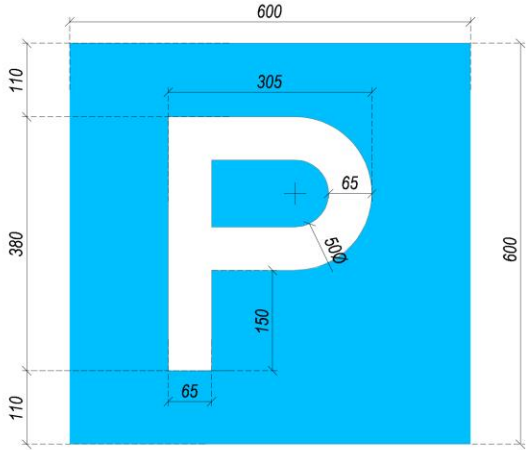

INFORMATORY SIGN FOR MOTORIZED VEHICLE PARKING

mounting type : Center of the post
clear mounting height : 2500mm
background : blue (retroreflective)
text : white (retroreflective)

WARNING SIGN AT PEDESTRIAN CROSSING

Nomenclature: (SB6)

mounting type : cantilevered from post
clear mounting height : 2500mm

border - red (retroreflective)
legend - black
background - white (retroreflective)

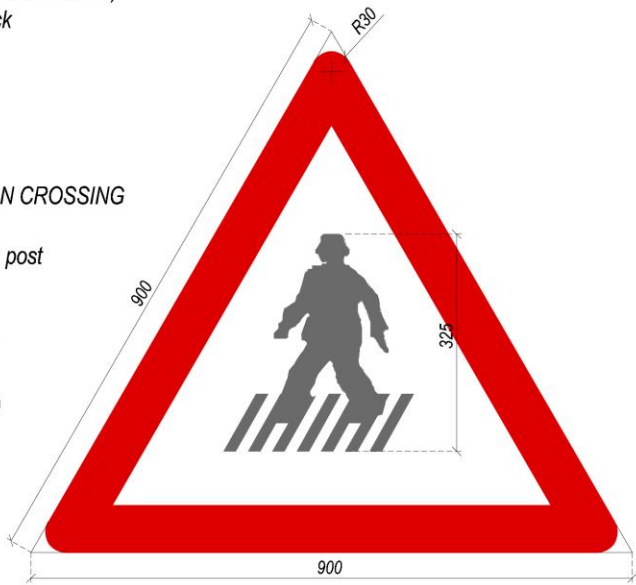

NOTE:
ALL DIM. TO BE READ AND NOT MEASURED

Parking Signage Detail a

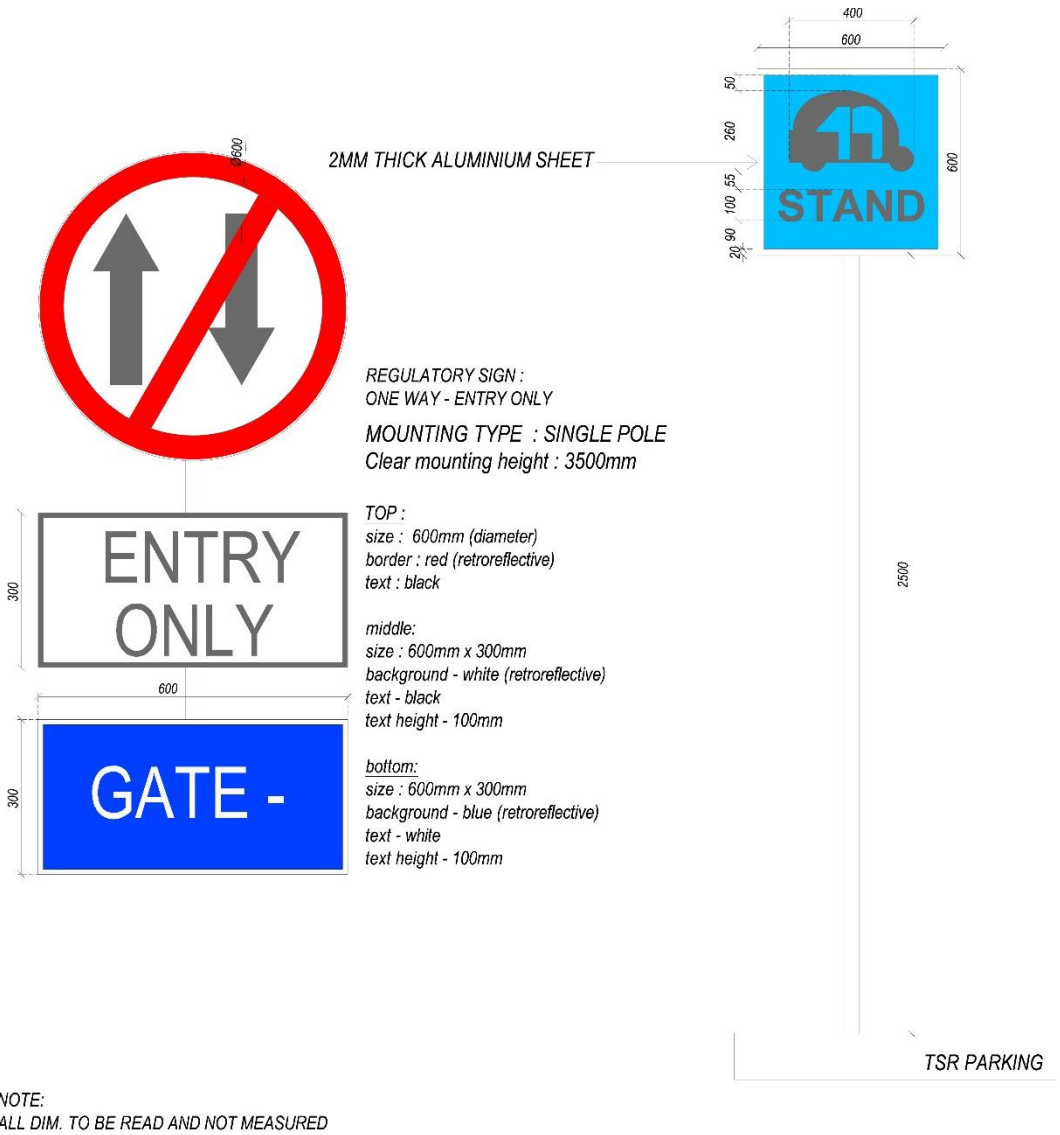



5 Financing

Bus terminals include a wide array of public facilities, primarily to meet public mobility requirements, but they also provide an opportunity for the delivery of other social services, as well as promotion of economic activity. Building a bus terminal is a capital intensive process, involving large initial cost, and relatively low operating cost and revenues (Anand & Lall 2009). Thus, financial structuring of a bus terminal project plays a pivotal role in its developmental outcome.

5.1 Funding and Financing Models

The bus terminal development process usually has two media of budgetary allocations –funding and financing (Figure 21). These are explained below (Committee for Melbourne 2015):

- Funding:** Funding mostly suggests providing money for a project, say by a sponsor or benefactor. It can also be sourced directly from users of the infrastructure facility, or indirectly through taxes and charges (or rates for local government). The willingness (of government and users) to commit funds is the ultimate factor determining the level and pace of the facility’s development. In the context of bus terminal development, funding relates to commitment of funds by the government, or a government authority such as an STU.
- Financing:** Financing refers to the capital invested in an infrastructure asset. This includes infrastructure ownership (equity), as well as lending to a project; the latter incurs interest expense and needs to be repaid (debt). Financing is crucial, in that, it bridges the gap between the large upfront costs (of an infrastructure investment) and the revenues (that can be expected later on) to recover the costs. Whether investing equity or debt, investors are essentially banking upon the chance that the infrastructure investment will yield a positive return, and refurnish their original investment stake. In addition to providing funds, the infrastructure investment also helps generate revenue (such as a bank loan), solicit contributions, seek sponsors etc. (The Business Council of Australia 2013). The financing process is further differentiated in two ways:

- a) Debt financing i.e. Commercial Bank Loans:** Debt financing does not secure any ownership control for

the lender, but does involve repayment of principal, with interest. Time period, interest rates, security, and other terms of the loan vary according to what the loan is being used for (Longwood Small Business Development Centre 2012).

- b) Equity financing-** In its most basic form, equity financing yields repayment (and/or return) of principal only if the venture yields sufficient funds/revenues for that purpose, hence the term risk capital (Longwood Small Business Development Centre 2012). Due to the risk(s), the possible capital sources could be by anyone, anywhere, anytime, depending on the amount, purpose, and stage of business at issue. In case of equity financing, considerations of ownership, profit, benefit sharing, operational control, valuation, and exit strategies, always merit careful evaluation. Equity financing covers a wide array of capital source types. In general, there are several types.

Bus terminal projects qualify as public interest projects. As such, they rely extensively on the revenue structure involved in provision of good public services and infrastructure facilities. Government funding thus is (and has been) an attractive and justified source of capital for such projects.

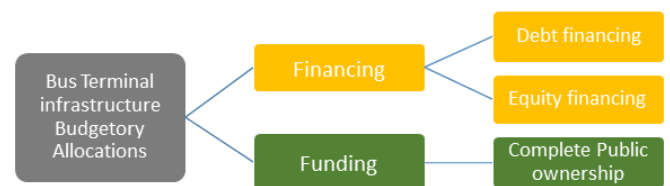

Figure 21: Budgetary Allocations flowchart for Bus terminals

**Note: The availability of capital or financial products does not obviate the need for funding. A funding source must be available, to supplement finance.*

In the past, bus terminals were developed solely under ‘public ownership’. The government agencies (a single agency such as STU/public transport operator) solely funded the projects, as well as solely developed and operated them. More recently, the inclusion of modern (or ‘smart’) terminal settings—such as multimodal integration, advanced architecture, attractive terminal facilities (comparable to those at airports), and commercial development in the terminal and its vicinity—have necessitated the development of a financial structure based on an interface of private investors and government regulators, aided with the regulators’ own internal revenue generation. In projects wholly reliant on public ownership, the available public funds are proving insufficient to achieve current minimum standards

of service. Therefore, urban local bodies (ULBs) have been seeking alternative private sources of financing (Khan. R 2013). Lately, the government solicits private participation in funding capacity building, through PPP's⁴², commercial bank lending, take out financing, infrastructure financing institutions, infrastructure debt funds, external commercial borrowing, foreign direct investments etc.

The financial structure of bus terminals is characterized by limited recourse funding i.e. investors can be repaid only from the revenue generated by the project (Department of Industrial Policy and Promotion 2011). In such an arrangement, repayment is threatened due to vulnerability arising from factors such as uncertainty of demand (bus/passenger) forecasts, tariff increase reversals due to public rejection, challenging of environmental clearances, and arbitrary reneging of contracts and non-payment by monopoly (financially weak) public utilities. To mitigate these complex risks, government agencies have structured robust revenue models—involving user charges, targeted subsidies, and viability gap funding—which generally provide better return prospects on risk capital. Common among such models are Build Operate Transfer (BOT) and Build Operate Own (BOO) arrangements, joint ventures, leasing contracting, management contracts etc. All these revenue models qualify as PPP projects. These different types of contracts are described below (Public Private Partnerships - The Haryana Experience 2015):

1. **Service Contract:** Under a service contract, the government (public authority) hires a private company/entity to carry out one or more specified tasks/services for a period (typically 1-3 years). The government or public authority remains the primary provider of the infrastructure service, contracting out only parts of operation to the private partner. This partner must perform the service at the agreed cost and up to performance standards set by the public sector. It receives (from the government or public authority) a predetermined fee, which may be a onetime fee on unit cost basis,

or some other. Typical service contracts at a bus terminal relate to provision of private guards, cleaning and maintenance staff etc.

2. **Management Contract:** A management contract broadens the scope of the services to be contracted out, to include partial/complete management and operation of the public service. This arrangement assigns daily management control and authority to the private partner/contractor, even as the ultimate obligation for service provision remains in the public sector. In most cases, the private partner provides working capital but no financing for investment. It receives compensation at a predetermined rate, for labour and other anticipated operating costs. Management contract variants include supply and service contract, maintenance management, and operational management.
3. **Lease contract:** Under a lease contract, the private partner is responsible for the service in its entirety, including obligations relating to quality and service standards. It provides the service at own expense and risk, excluding new and replacement investments, which remain the public authority's responsibility. A lease contract typically lasts 10 years, renewable up to 20. It transfers entire responsibility for service provision from the public to private sector, including the financial risks associated with operation and maintenance. In particular, the private operator is responsible for losses and unpaid consumers' debts. A lease does not involve sale of assets to the private sector.
4. **Concessions:** A concession makes the private sector operator (concessionaire) responsible for complete delivery of services in a specified area. Complete delivery comprises operation, maintenance, collection, management, construction, and rehabilitation of the system. This signifies that the private sector operator is now responsible for all capital investment. Alt-

⁴² *Public Private Partnership - It is defined as "the transfer to the private sector of investment projects that traditionally have been executed or financed by the public sector" (IMF 2004). According to Ministry of Finance, Government of India, 'PPP project' signifies a project based on a contract or concession agreement, between Government or statutory entity on the one side and a private sector company on the other side, for delivering infrastructure service*

on payment of user charges. The PPP model helps government implement its schemes in partnership with the private sector. Typically, these are set up in a form of a Special Purpose Vehicle and are engaged in financing, operating and maintaining of the assets and project.

though the private sector operator is responsible for providing the assets, such assets are publicly owned even during the concession period. Additionally, the public sector is in charge of establishing performance standards and ensuring adherence by the concessionaire. In essence, the public sector's role evolves from service provider to regulator, regulating the price and quality of service. The concessionaire collects the tariff directly from system users. The tariff is typically established by the concession contract, which also includes provisions on how it may be changed over time. In some cases, the government may choose to provide financing support to help the concessionaire fund its capital expenditures. The concessionaire is responsible for any capital investments required to build, upgrade, or expand the system, and must finance them from own resources as well as from the tariff generated by the system (or revenue generated from other sources within the system). A concession contract typically stands for 25-30 years, allowing the operator sufficient time to recover the capital invested, and earn return commensurate with the period of the concession. The government may contribute to the capital investment cost through subsidy (Viability Gap Funding or VGF⁴³), to enhance the concession's commercial viability. Concessions are effective contracts to provide investment for the creation of new facilities or rehabilitation of existing facilities. The main characteristics of concessions (and similar arrangements) are given below:

Build Operate Transfer (BOT): BOT (and similar arrangements) is a specialized concession in which a private firm (or consortium) finances and develops a new infrastructure project (or a major component) adhering to performance standards set by the government. Under BOT, the private partner provides capital required to Build (B) the new facility, Operate & Maintain (O&M) it for the contract period, and finally Transfer

(T) it to the government as per agreed terms. The private operator owns the assets for the contract period, sufficient to allow time for recovering investment costs through user charges.

BOT generally requires complicated financing packages, to meet the demand of large financing amounts and long repayment periods. Once the contract ends, the public sector assumes ownership of the facility, but operating responsibility can go three ways – back to public sector, contracted again to the developer, or contracted to a new partner.

Design Build (DB): Private sector designs and constructs at a fixed price and transfers the facility to the owning agency.

Build Transfer Operate (BTO): Private sector designs and builds the facility, and following construction, transfers it to the public owner. A concessionaire is awarded rights to operation, and return on investment.

Build Own Operate (BOO): Under a BOO contract between the public and private sector, a developer is authorized to finance, construct, own, operate and maintain an infrastructure (or development) facility, and is also allowed to recover its total investment through user levies. The developer owns the facility's assets and may assign its operation and maintenance to a facility operator. This arrangement excludes transfer of the facility to the government, government agency, or local authority. However, the government may terminate its contract after specified time period.

Design Build Operate (DBO): Ownership is in private hands, and a single contract transfers the responsibility of design, construction and operation of the infrastructure project.

Design Build Finance Operate (DBFO): Under this approach, the responsibilities of design, building, financing, operation and maintenance are bundled together and transferred to private sector partners. DBFO ar-

⁴³ *Viability Gap Funding - It signifies a grant (one-time or deferred) provided to support infrastructure projects that are economically justified but lack financial viability, owing to long gestation periods and inability to align user charges with commercial levels. Infrastructure projects also involve externalities that are not adequately captured in direct financial returns to the project sponsor. Through*

the provision of a catalytic grant assistance of the capital costs, several projects may become bankable and help mobilize private investment in infrastructure. Government of India has notified a scheme for Viability Gap Funding to infrastructure projects that are to be undertaken through PPPs.

rangements vary greatly in terms of the degree of financial responsibility transferred to the private partner.

BOT annuity/shadow user charge: In this BOT arrangement, the private sector partner receives returns (on total investment) not through user charges but annual payments (annuity) from the public authority. The annuity is determined either by a bid by the developer, or by the usage of the created facility.

The above PPP models include a range of arrangements with respect to the responsibilities of construction, upgrading, maintenance, and operation of infrastructure. These arrangements are embedded in the respective PPP model’s contract or concession agreement, i.e. the agreement between a government entity and a private sector company, binding the company to deliver an essential service on the payment of user charges. It defines the frameworks under which parties are legally bound to meet their respective project development and service delivery obligations. Figure 22 summarizes the PPP revenue model contracts with their responsibilities, risk and ownership, with respect to their time durations.

Option	Asset Ownership	O&M	Investment	Comm. Risk	Duration
Service Contract	Public	Both	Public	Public	1-2 yrs
Management Contract	Public	Private	Public	Public	3-5 yrs
Lease	Public	Private	Shared	Shared	8-15 yrs
BOT/BOO	Public/Private	Private	Private	Private	20-35 yrs
Annuity	Private	Private	Private	Public	10-15 yrs

Figure 22: Various Revenue model contracts with their responsibilities, risk, and ownership and time durations (Source: Investopedia)

All these revenue models (and respective contract agreements) entail equal involvement and responsibility sharing between the public and private players. This type is predominant among the financial arrangements involved in urban transport and public infrastructure projects. Apart from these, financial frameworks in the realm of full privatization, such as joint ventures, can also serve bus terminal development and operation.

Joint Venture: Joint ventures are alternatives to full privatization. Under a joint venture, the infrastructure is co-owned and operated by the public sector and private operators (Public Private Partnerships - The Haryana Experience 2015). The public and private sector partners can either form a new company, or special purpose vehicle (SPV) (Figure 23), or assume joint ownership of an existing company through a sale of shares to one or several private investors. The main reason for this is to better protect the parent company or its subsidiary in a holding company structure.

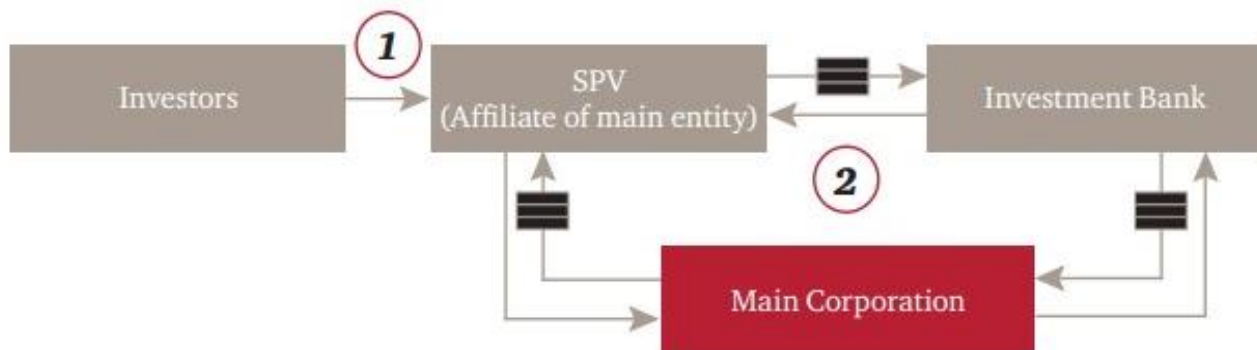

Figure 23: Diagram shows the typical structure of a SPV (Source: Investopedia)

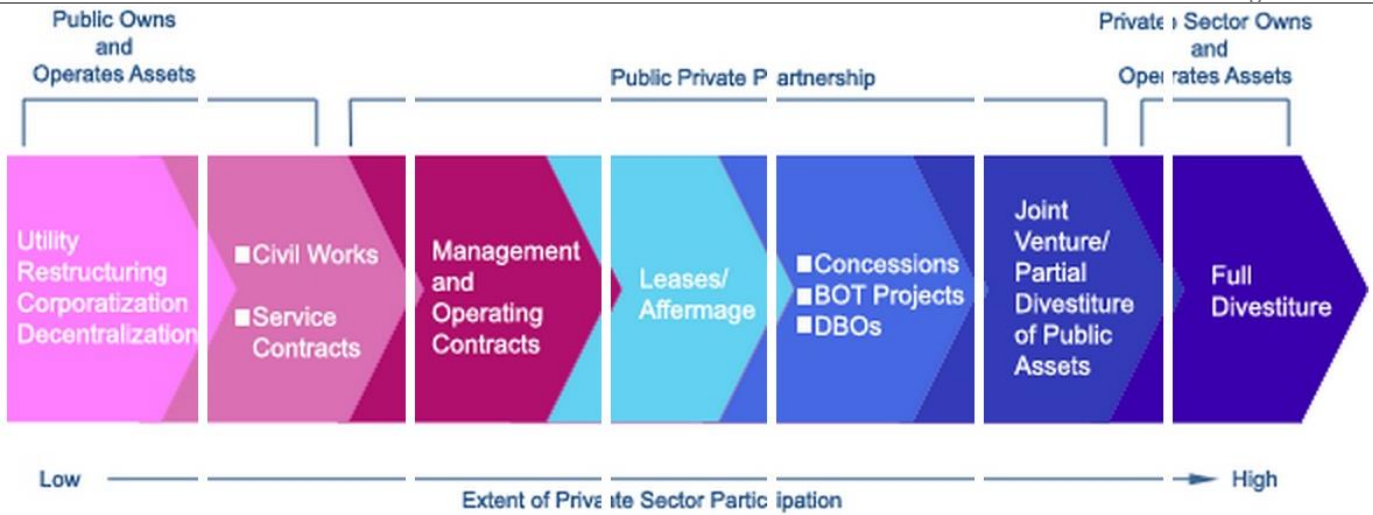

Figure 24: Private sector participation spectrum (Source: ppp.worldbank.org)

Creating an SPV is simple but maintaining it is a tedious job. It was observed in a few cases that SPVs shied away from their infrastructure provision function, resulting in a poor image of the system. It goes without saying that creating infrastructure before contracting out the services, goes a long way in attracting the private sector. A greater problem has to do with the SPVs shying away from the monitoring function, in which case, the private operator can deviate from the agreed level of service (Parashar & Dubey 2011). Therefore, an SPV should be considered only after extensive thought to other options, such as executing an exhaustive agreement which clearly defines rights and liabilities of both the parties without creating a separate entity.

A key requirement of joint ventures is good corporate governance, in particular the ability of the company to maintain independence from the government, because the government is both part owner and regulator. Being a shareholder however, the government has an interest in the profitability and sustainability of the company, and can work to smoothen political hurdles (Public Private Partnerships - The Haryana Experience 2015).

Each of the above discussed PPP models come in a wide range of forms, varying in extent of risk involvement for the private party. The terms of a PPP format are typically set out in a contract or agreement which outlines the responsibilities of each party, and clearly defines allocated risk. Figure 24 depicts the extent of private sector participation across a spectrum of agreements.

The Planning Commission of India (2011) recommends that land for bus terminal development be provided by the government, and development be undertaken preferably on PPP basis, with funding divided equally between the government and the private partner.

Each variant of PPP model has pros and cons, and varying degree of suitability for achieving the major objectives of public-private partnership. Some factors useful for deciding on a suitable PPP model, include special characteristics of a sector, its technological development, legal and regulatory regimes, and public and political perception about the services in that sector. No single PPP model can satisfy all conditions concerning a project’s locational setting, and its technical and financial features. Most suitable model should be selected, taking into account the local political, legal and socio-cultural circumstances; maturity of the state’s/city’s PPP market; and the financial and technical features of the projects and sectors concerned (United Nations Economic and Social Commission for Asia and the Pacific 2011).

Large public infrastructure projects (such as bus terminals) require investments with long gestation period (Department of Industrial Policy and Promotion 2011). In the BOT format of PPP, private participation is invited in terms of equity and expertise. Herein, private sector develops the infrastructure (bus terminal) and operates it as per the contract terms, for a given time period, before transferring it back to the public sector

owner. Figure 25 presents a typical BOT model structure.

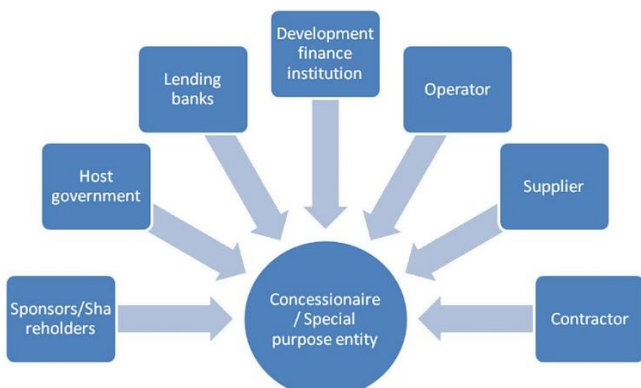

Figure 25: Typical BOT structure (Source: Wikipedia)

Due to BOT's long-term nature, complete revenue is usually raised during the concession period. The rate of increase (in revenue) is often tied to a combination of internal and external variables, allowing the proponent to reach a satisfactory internal rate of return for its investment, which works well in case of bus terminal projects. Another huge advantage of BOT is that in the case of limited public funds and inadequate resources to successfully undertake bus terminal development, the private sector may be able to initiate the project on its own.

5.2 Cost and Revenue Generation

Public ownership funding (for bus terminal infrastructure development) is provided independent of the promise of any returns, and is largely considered sunk cost. However, private participation, irrespective of the format, entails financial returns. Thus, it is imperative that the PPP model works as a business model, with planned revenue sources and an accurate assessment of the cost-revenue model.

The traditional revenue source for bus terminals is the usage charge paid by buses accessing the terminal, on the lines of a one-time fee (typically Rs. 100 per entry), and in case of overnight parking, additional fee in the form of parking charge (typically Rs. 100 per bus). Other traditional sources include dormitory charges for drivers and bus staff (typically Rs. 50 to Rs. 80 per person per night), rental from retail outlets (eateries, book shops etc.) within the terminal premise, and private vehicle parking charges. Non-traditional revenue sources include development of real estate to be leased for of-

fice/retail purpose, and/or development of infrastructure to be leased out as hotels, guesthouses or dormitories.

Traditional revenue sources at a bus terminal have proved sufficient to offset operational and maintenance expenditure. But this may not happen when STU-operated terminals levy usage charges only on external operators (private or other STUs), exempting their own buses. Thus, local terminals are rarely operated and maintained independently, and have no independent revenue source. Traditional revenue sources have proved insufficient to offset terminal development costs. Hence, non-traditional revenue sources need to be cultivated and tapped into, to attract private investments.

Bus terminals require adequate funds from alternate sources, to meet the objective of facilitating development (Nallathiga 2015). Lately, bus terminal projects have explored working business models that involve sufficient revenue generation for the STUs. Of all alternate sources, land plays an integral role as a revenue generator. Rich STUs, in their new terminal projects, are developing floor space over the terminal building, as space for offices, to attract revenue through long term lease or sale. However, planners and project proponents treat this as secondary interest (primary being terminal development), often leading to development which isn't aligned to meet the requirements of potential buyers or tenants of the space. For instance, these offices lack separate access, potential for corporate branding, and in most cases, are designed without considering parking or services requirement for on-site commercial activities.

An integrated approach to terminal development is required i.e. laying equal emphasis on developing and tapping land as a revenue source, as well as using the site for the primary purpose of serving bus commuters and operators. This requires an understanding of market demand, land valuation, real-estate development potential etc. For instance, as a thumb rule, it can be expected that after deducting the development cost component of real estate (as revenue source), and accounting for money's cost (interest rates etc.) and expected profit, no more than a third of the value of commercially generated land can be used for funding the terminal's development⁴⁴. This helps determine the

⁴⁴ At current estimated value of real estate and development cost

minimum land or floor area to be designated for revenue generation, to fund a particular terminal's development. The PPP approach to private participation is advantageous, for it merges (under expert advice) the public need of the terminal site, with the private need to (maximise revenue), yielding an optimum outcome which meets (and in some cases may exceed) all requirements. Section 5.4 presents the expected development cost of a bus terminal (including parking, excluding the cost of development of real estate), under different scenarios and for different typologies.

5.3 Land Acquisition and Sourcing

Though there are instances of using land as revenue source for bus terminal development projects, it is still often ignored or not exercised to existing potential, and is rarely accessed to finance the creation and development of infrastructure. This is because of concomitant problems like redevelopment, rehabilitation, resettlement etc. (Nallathiga 2015). Lately nevertheless, land-based financing is fast becoming an important element of infrastructure finance. The basic underlying principle is 'the benefits of infrastructure projects are capitalised into land values' (Nallathiga 2015), which works so long that the land markets are not subject to distortions, and are doing well on efficiency, equity and accountability. Land based revenues have greater implication for development, than other traditional means of limited recourse funding. Funds from land based revenue sources can be effectively deployed for improving public needs, and infrastructure development (Nallathiga 2015).

In the Indian context, the challenge of securing land is particularly acute, owing to an inherent scarcity of land, particularly land allotted for transport (including public transport) use. With STUs struggling to find land for serving the increasing demand of bus based transport, finding land for use as revenue source to develop bus infrastructure (such as terminals and depots), is a tall order. Issues relating to land governance and land-tools⁴⁵ further impinge on availability of land allotted for development of public infrastructure projects.

To get past the challenge in securing land, infrastructure development projects that use land as a revenue

source can opt for Transfer of Development Rights (TDR). This is a market based technique that encourages voluntary transfer of growth from places where a community prefers less development to those where a community prefers more development. The former are termed sending areas and include environmentally-sensitive properties, open spaces, agricultural land, wildlife habitat, historic landmarks, or any places important to a community. The latter are termed receiving areas and include places which the public, by consensus, considers appropriate for extra development due to proximity to essentials like jobs, shopping, schools, transportation and other urban services. (Higgins 2015).

Mostly, the land/sites allotted for bus terminal projects are worked out through zoning, in the master plan. As master plans go through continuous evolution and developmental phases, such land is often earmarked subject to acquisition from an earlier land use. TDR works well in such a system, and can be advantageously practised to acquire land for development purposes. Land acquisition in urban areas, for public purposes is a complicated, costly and time consuming process. To minimize the time involved, and facilitate the process, TDR strategizes provision of additional built up area in lieu of the area relinquished (or surrendered) by its owner, such that the additional built up area can either be used by the owner or further transferred/sold to a third party. Thus, local government bodies can use TDR to undertake development of bus terminals sites. Through the use of this tool, they can allow identified property owners to give up their rights to develop these spaces, in lieu of additional FAR over the remaining property/site or any other site. To facilitate this further (in some cases), such development rights can be traded by the property owner in the open market. TDR can also be used to raise finances for terminal development in conditions where the monetary value of the development rights offered, is higher than the relinquished land's value. The public stands to gain, as TDR allows avoiding large public expenditures, by using private sector funds to purchase the development rights⁴⁶. TDR

⁴⁵ A land tool is a practical way to solve a problem in land administration and management. It is a way to put principles, policies and legislation into effect.

⁴⁶ Development rights - Land ownership is commonly described as consisting of a bundle of different rights. Usually when someone purchases a parcel, they purchase the entire bundle of rights that

may also be offered to private sector participants under the PPP model of development.

need to modify their development norms, to support PPP in bus terminal development.

5.4 Financial Requirement

Bus terminal funding or financing requirement is based on the cost for development of the terminal facility. This cost depends on different development scenarios and the site area involved. Site area requirement in turn, depends on the demand the terminal is expected to cater. Different development scenarios also influence the overall site area requirement. For instance, in the real estate development scenario, site area requirement is high. This is because, as part of the PPP strategy, dedicated real estate space is developed as a resource to raise revenue. This necessitates provision of associated infrastructure, especially parking. Parking development consumes additional land and funds. Thus, this scenario requires higher land and funds for terminal development (considering parking development is part of terminal development). Graphs in this section present a relationship between bus flow requirement (demand to be catered), expected terminal development cost (in crores), and commercial built up space offered (in square meter) for different development scenarios. These scenarios include one with no real estate development (completely publically funded), and six different PPP scenarios where land is developed as a resource. Of the six PPP scenarios, one involves at grade car and bus parking; others include combinations of multi-level car parking with ramp, multi-level mechanized car parking, basement car parking (only under the terminal building), and multi-level bus parking with ramp. Each scenario's associated development cost has been worked out based on land and built up area requirements (presented in previous sections). Land and development cost requirement is based on the assumption that only that much real estate (area) is developed as is required to exactly fund the development cost of the terminal complex.

Apparently, for most PPP scenarios, the FAR consumed is between 3 and 6 (assuming multi-level bus and car parking are counted as built up area), but most cities allow an FAR of 1 for bus terminal sites. Clearly, cities

might be associated with the land. Owning a development right means that one can own the right to build a structure on the parcel. Such award will entitle the owner of the land to a Develop-

ment Rights Certificate (DRC), which s/he may use for self or transfer to any other person. These development rights may be voluntarily separated and sold off from the land.

Financial Requirements

Aa

Typology	Inter State	A
Operation	Fixed Route Bay	a

Terminal Development Cost (including Commercial)

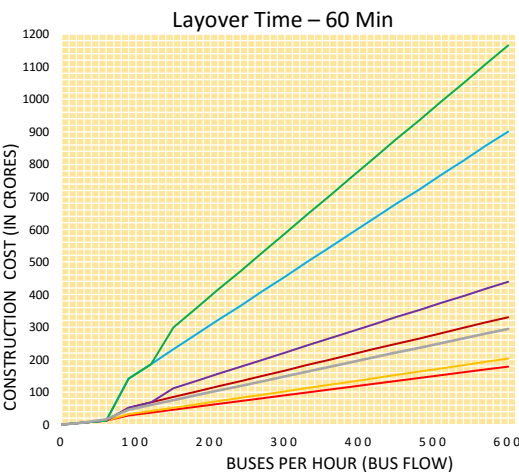
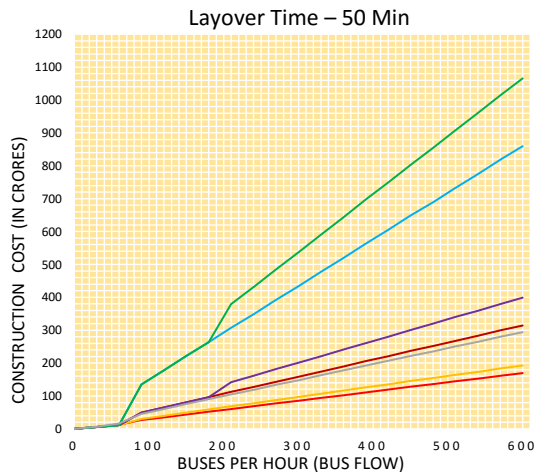
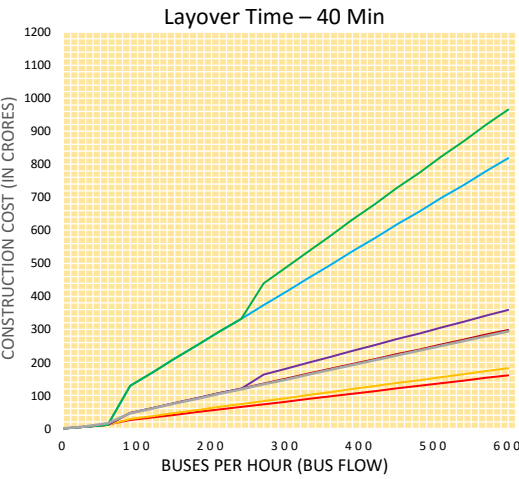
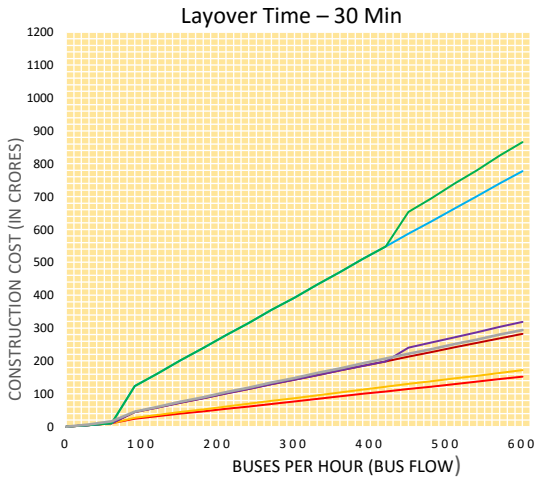
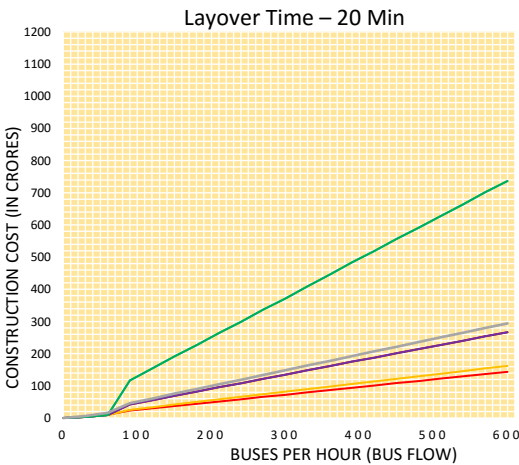
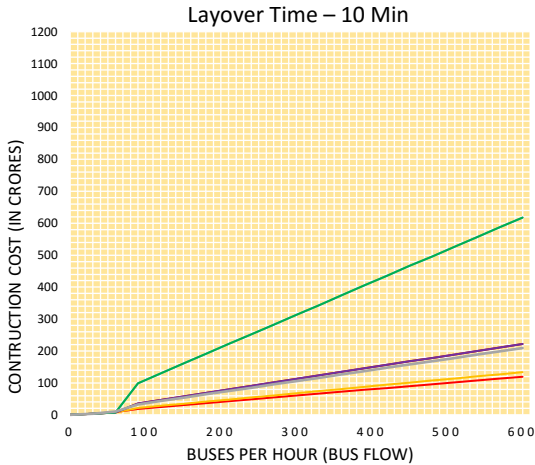

In all layover times, the hike in construction cost is due to feasibility of terminal functions like cloak room, eatery, terminal offices and dormitories for passengers, resting area for drivers in addition to service facilities like toilets and drinking water, ticket counter, railway reservation office, canteen for staff, tourist information, dormitories for bus staff, security personnel, canteen for bus and terminal staff, and administrative offices after the bus flow of 60 buses per hour.

The hike observed in 30 min, 40 min, 50 min and 60 min layover time, at 420 buses per hour, 240 buses per hour and 120 buses per hour respectively is attributed to increased real-estate/ commercial development to offset additional cost of development of multilevel car and bus parking (where applicable). The demand for multilevel car and bus parking becomes feasible when it exceeds the minimum threshold of 120 and 130 respectively.

1. Without Real estate Development, at grade Parking (Car & Bus).
2. With Real estate Development, at grade Parking (Car & Bus).
3. With Real Estate development, Multilevel (Ramp) Car and (At grade) Bus parking.
4. With Real Estate development, Multilevel (Mechanical) Car

5. With Real Estate development, Multilevel (Ramp) Car and Multilevel (Ramp) Bus parking
6. With Real Estate development, Multilevel (Mechanical) Car and Multilevel (Ramp) Bus parking
7. With Real Estate Development, Basement Parking Car parking & at grade Bus Parking.

Typology	Inter State	A
Operation	Fixed Route Bay	a

Commercial Built-up Area

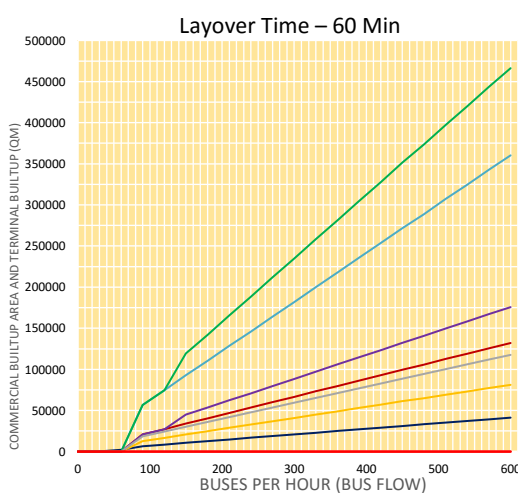
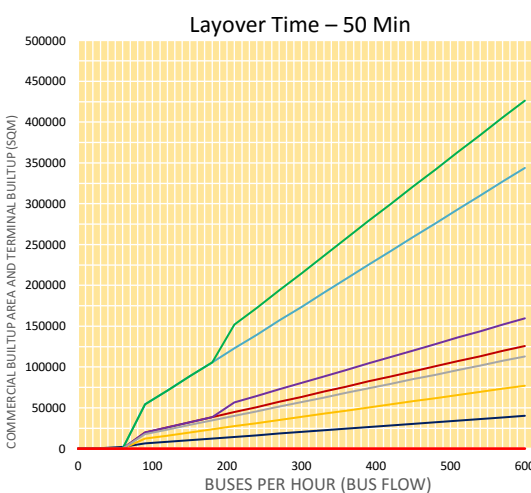
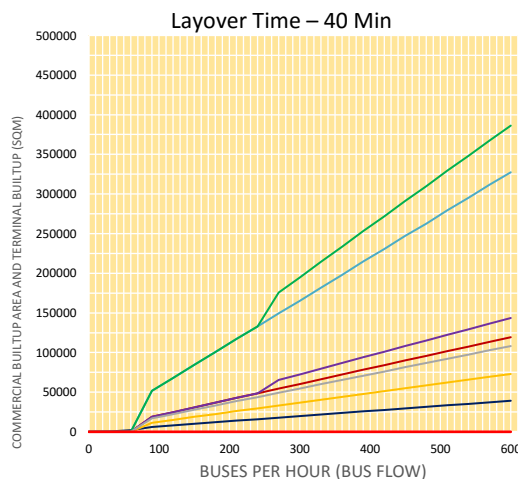
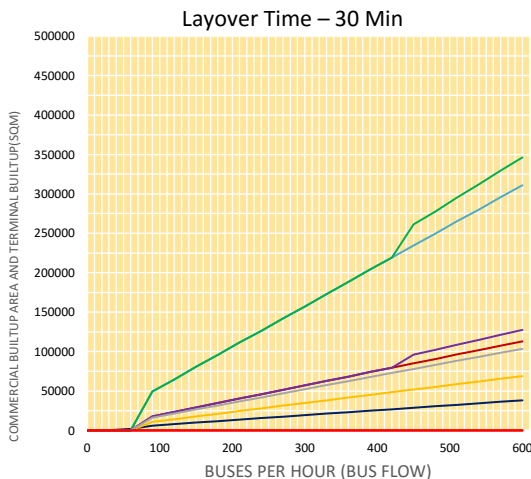
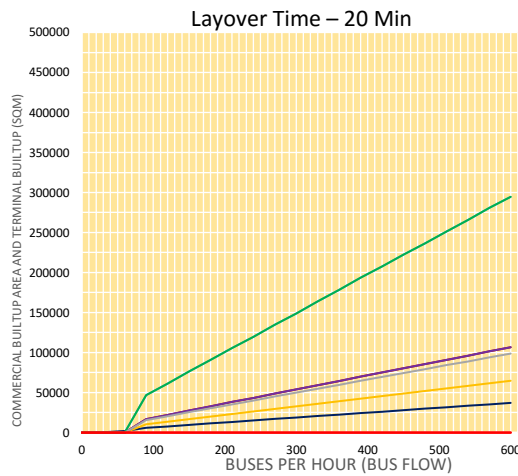
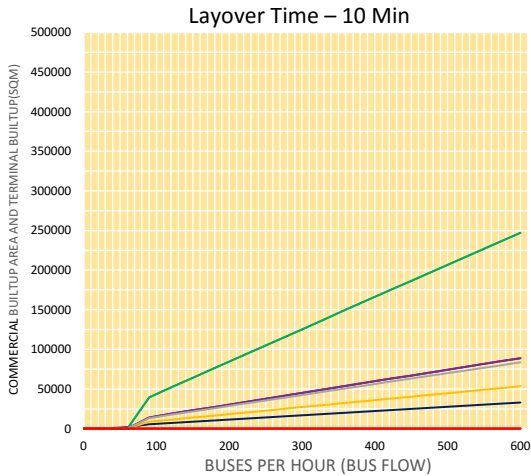

In all layover times, the jump observed in commercial area requirement at 90 buses per hour is due to increased real-estate/commercial development to offset additional cost of development of multilevel car parking. The demand for multilevel car parking becomes feasible when it exceeds the minimum threshold of 120.

At layover time 30 min, 40 min, 50 min, and 60 min, the jump at 420 buses per hour, 240 buses per hour, 180 buses per hour and 120 buses per hour respectively refers to the jump in car parking requirement attributed to increased real-estate/commercial development to offset additional cost of development of multilevel car and bus parking. The demand for multilevel car and bus parking becomes feasible when it exceeds the minimum threshold of 120 and 130 respectively

1. Without Real estate Development, at grade Parking (Car & Bus).
2. With Real estate Development, at grade Parking (Car & Bus).
3. With Real Estate development, Multilevel (Ramp) Car and (At grade) Bus parking.
4. With Real Estate development, Multilevel (Mechanical) Car

5. With Real Estate development, Multilevel (Ramp) Car and Multilevel (Ramp) Bus parking
6. With Real Estate development, Multilevel (Mechanical) Car and Multilevel (Ramp) Bus parking
7. With Real estate Development, Basement Parking Car parking & at grade Bus Parking.

Financial Requirements

Ab

Typology	Inter State	A
Operation	Dynamic Bay	b

Terminal development Cost (including commercial)

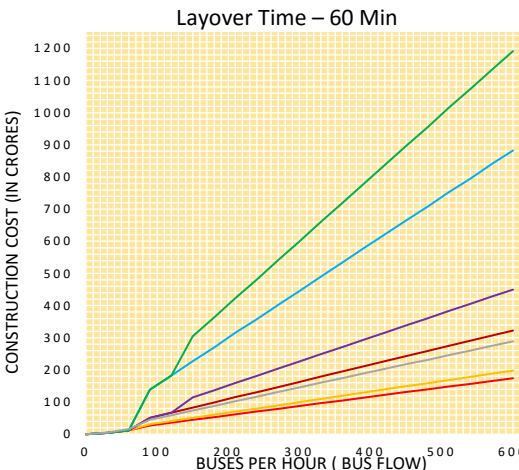
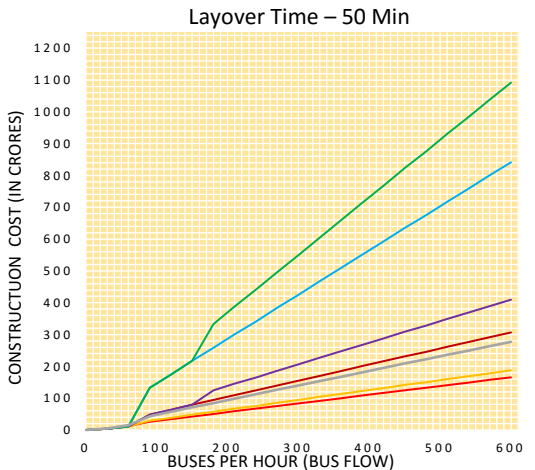
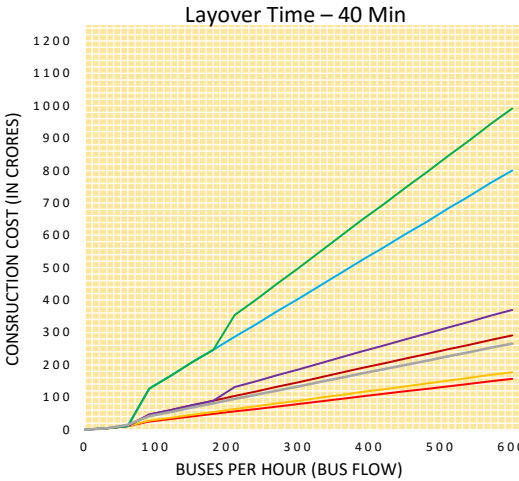
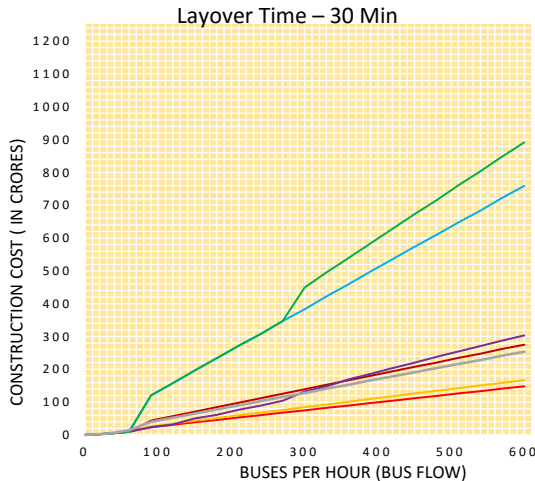
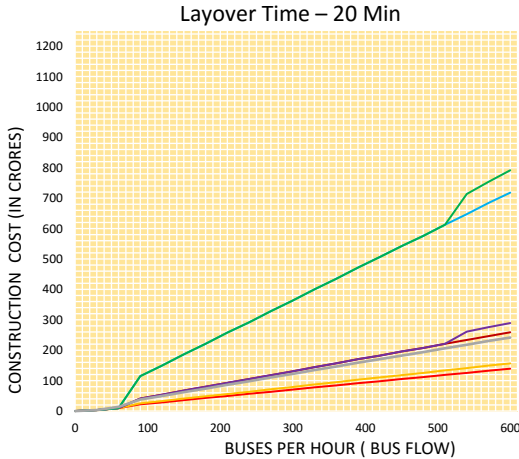
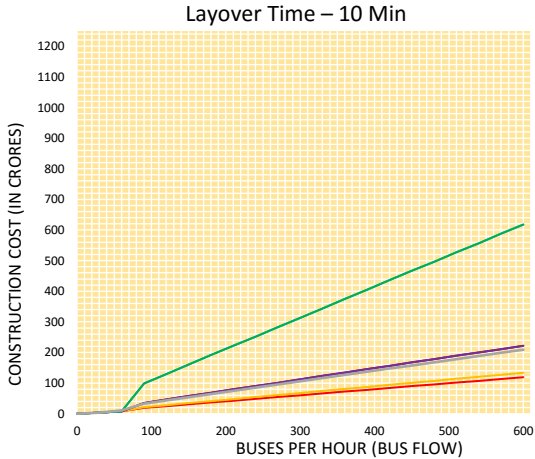

In all layover times, the hike in construction cost is due to feasibility of terminal functions like cloak room, eatery, terminal offices and dormitories for passengers, resting area for drivers in addition to service facilities like toilets and drinking water, ticket counter, railway reservation office, canteen for staff, tourist information, dormitories for bus staff, security personnel, canteen for bus and terminal staff, and administrative offices after the bus flow of 60 buses per hour.

The hike observed in 20 min, 30 min, 40 min, 50 min and 60 min at 510 buses per hour, 270 buses per hour, 150 buses per hour and 120 buses per hour respectively is attributed to increased real-estate/commercial development to offset additional cost of development of multilevel car and bus parking (where applicable). The demand for multilevel car and bus parking becomes feasible when it exceeds the minimum threshold of 120 and 130 respectively.

- | | | |
|--|--|--|
| 1. Without Real Estate Development, at grade Parking (Car & Bus). | 5. With Real Estate development, Multilevel (Ramp) Car and Multilevel (Ramp) Bus parking | 6. With Real Estate development, Multilevel (Mechanical) Car and Multilevel (Ramp) Bus parking |
| 2. With Real Estate Development, at grade Parking (Car & Bus). | 6. With Real Estate development, Multilevel (Mechanical) Car and Multilevel (Ramp) Bus parking | 7. With Real Estate Development, Basement Parking Car parking & at grade Bus Parking. |
| 3. With Real Estate development, Multilevel (Ramp) Car and (At grade) Bus parking. | 7. With Real Estate Development, Basement Parking Car parking & at grade Bus Parking. | |
| 4. With Real Estate development, Multilevel (Mechanical) Car | | |

Typology	Inter State	A
Operation	Dynamic Bay	b

Commercial Built-up Area

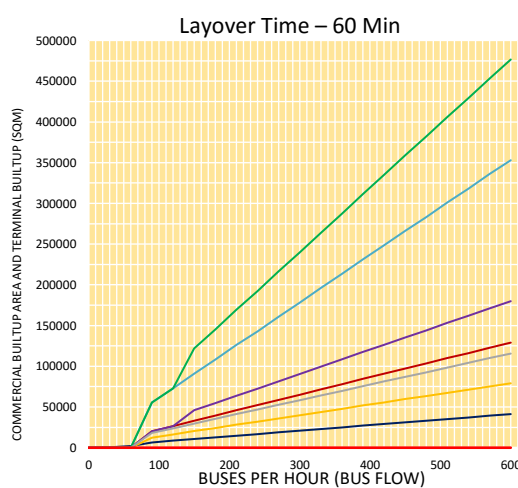
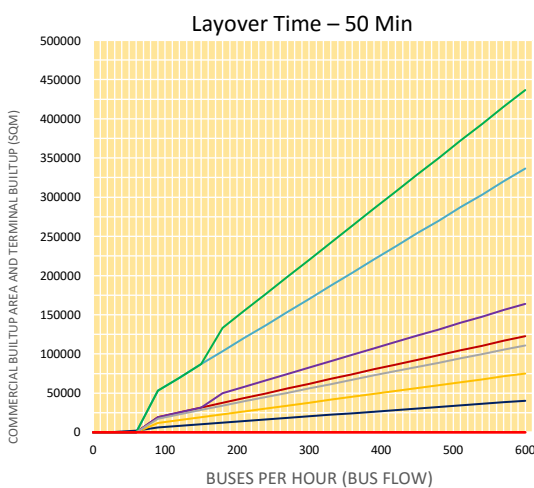
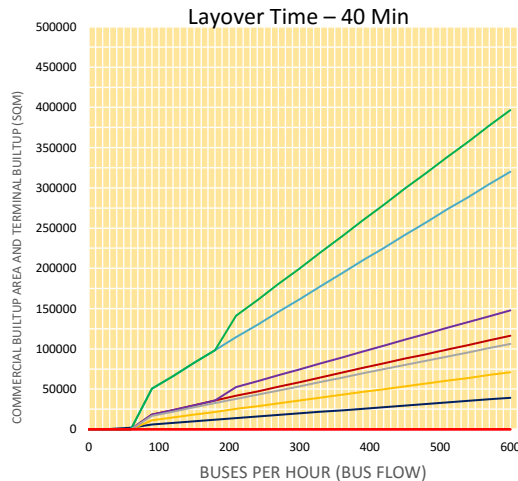
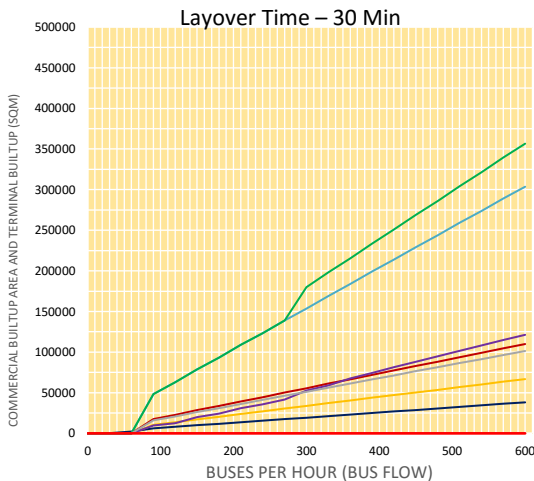
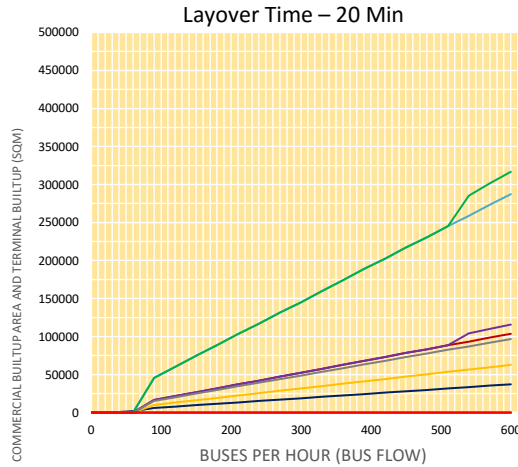
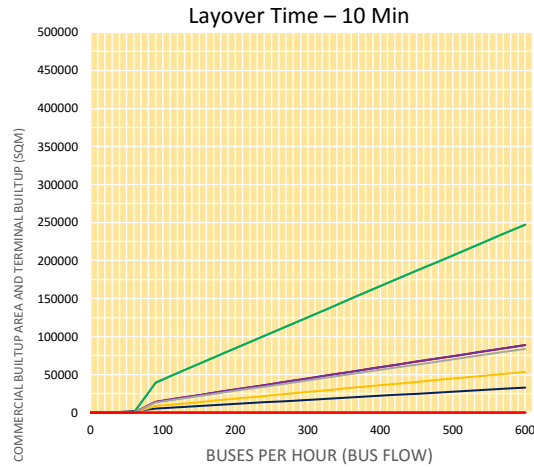

. In all layover times, the jump observed in commercial area requirement at 90 buses per hour is due to increased real-estate/ commercial development to offset additional cost of development of multilevel car parking. The demand for multilevel car parking becomes feasible when it exceeds the minimum threshold of 120.

At layover time 30 min, 40 min, 50 min, and 60 min, the jump at 420 buses per hour, 240 buses per hour, 180 buses per hour and 120 buses per hour respectively refers to the jump in car parking requirement attributed to increased real-estate/ commercial development to offset additional cost of development of multilevel car and bus parking. The demand for multilevel car and bus parking becomes feasible when it exceeds the minimum threshold of 120 and 130 respectively.

1. Without Real Estate Development, at grade Parking (Car & Bus).
2. With Real Estate Development, at grade Parking (Car & Bus).
3. With Real Estate development, Multilevel (Ramp) Car and (At grade) Bus parking.
4. With Real Estate development, Multilevel (Mechanical) Car

5. With Real Estate development, Multilevel (Ramp) Car and Multilevel (Ramp) Bus parking
6. With Real Estate development, Multilevel (Mechanical) Car and Multilevel (Ramp) Bus parking
7. With Real Estate Development, Basement Parking Car parking & at grade Bus Parking.

Financial Requirements

Ba

Typology	Local	B
Operation	Fixed Route Bay	a

Terminal development Cost (including commercial)

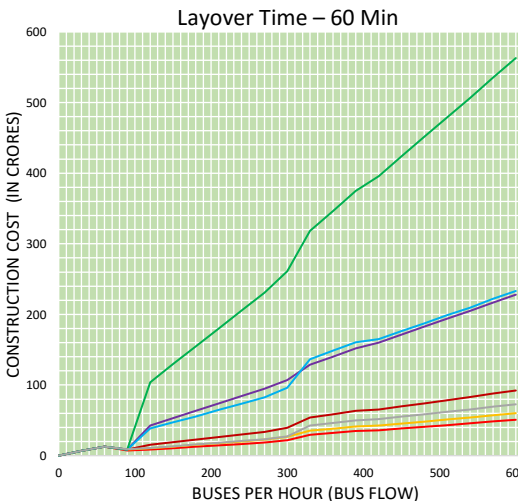
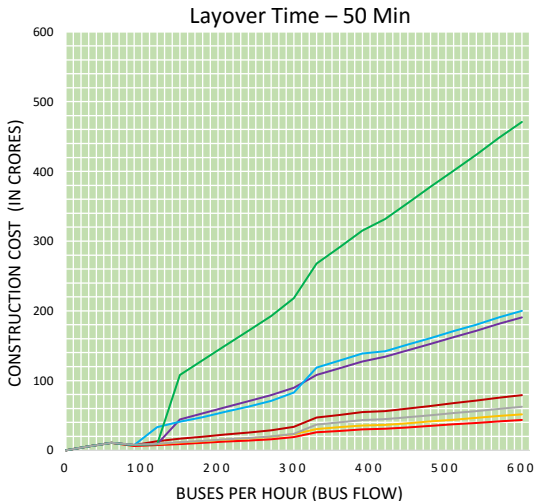
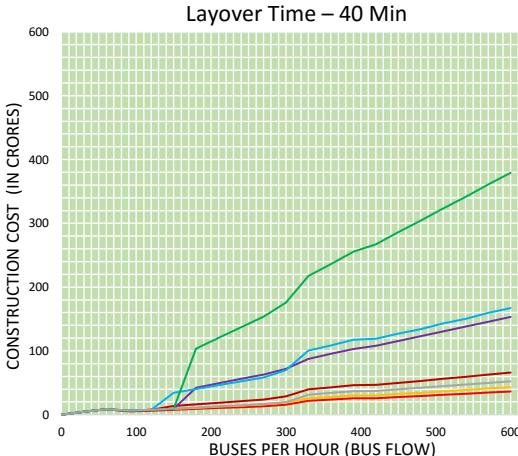
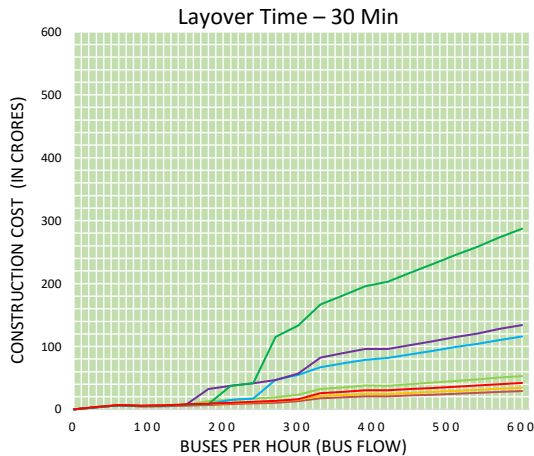
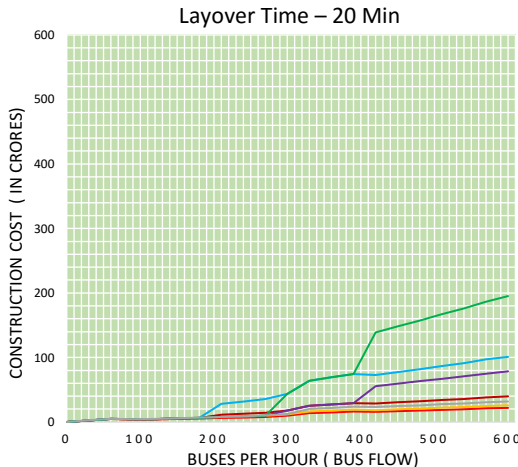
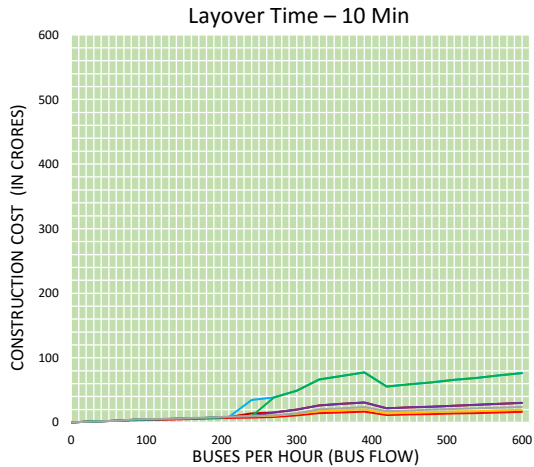

The jump observed in layover time 10 min after 240 buses per hour is due to increased real-estate/ commercial development to offset additional cost of development of multilevel car parking. The demand for multilevel car parking becomes feasible when it exceeds the minimum threshold of 120.

The hike observed at 180 buses per hour and 270 buses per hour; and 390 buses per hour for layover time 20 min and at 150 buses per hour and 180 buses per hour; and 240 buses per hour for layover time 30 min. Former two in both cases are attributed to increased real-estate/ commercial development to offset additional cost of development of multilevel car parking. The demand for multilevel car parking becomes feasible when it exceeds the minimum threshold of 120. The latter at 390 buses per hour for 20 min and 240 buses per hour for 30 min is attributed to increased real-estate/ commercial development to offset additional cost of development of multilevel car and bus parking. The demand for multilevel car and bus parking becomes feasible when it exceeds the minimum threshold of 120 and 130 respectively.

The jump observed in layover time 40 min, 50 min and 60 min at 150, 120 and 90 buses per hour is due to increased real-estate/ commercial development to offset additional cost of development of multilevel car and bus parking (where applicable). The demand for multilevel car and bus parking becomes feasible when it exceeds the minimum threshold of 120 and 130 respectively.

1. Without Real estate Development, at grade Parking (Car & Bus).
2. With Real estate Development, at grade Parking (Car & Bus).
3. With Real Estate development, Multilevel (Ramp) Car and (At grade) Bus parking.
4. With Real Estate development, Multilevel (Mechanical) Car

5. With Real Estate development, Multilevel (Ramp) Car and Multilevel (Ramp) Bus parking
6. With Real Estate development, Multilevel (Mechanical) Car and Multilevel (Ramp) Bus parking
7. With Real estate Development, Basement Parking Car parking & at grade Bus Parking.

Typology	Local	B
Operation	Fixed Route Bay	a

Commercial Built-up area

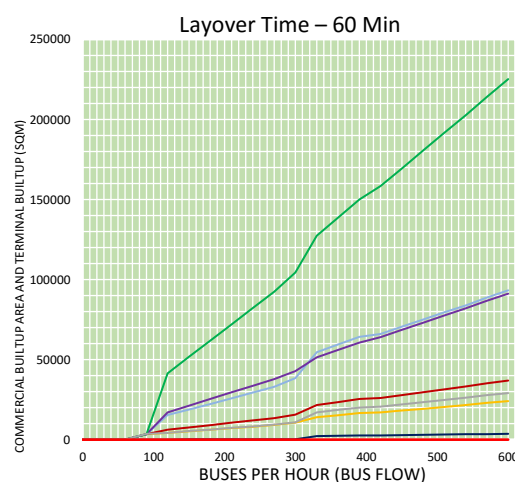
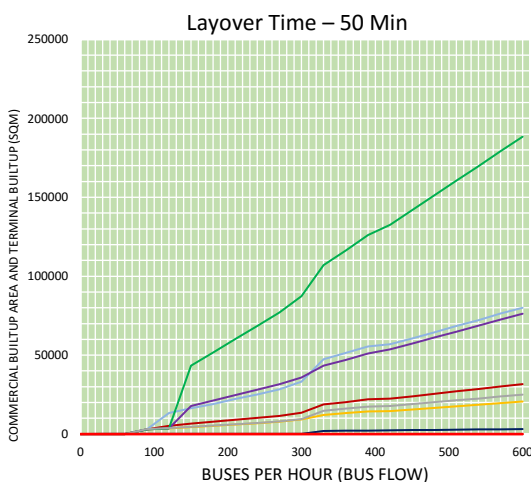
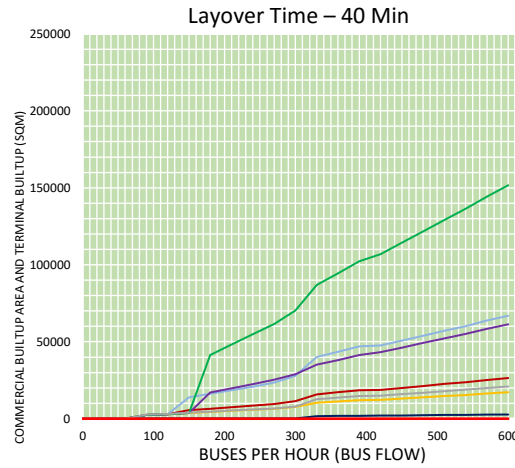
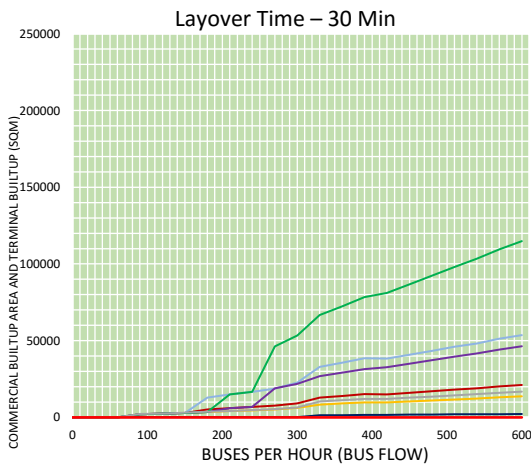
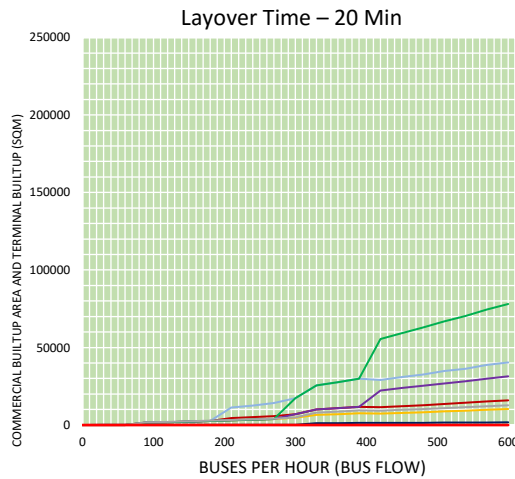
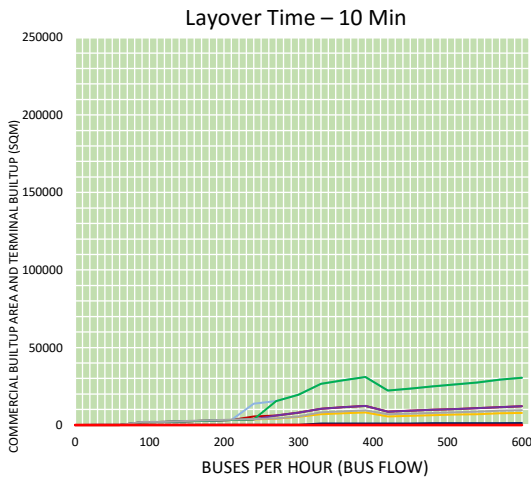

The jump observed in layover time 10 min after 180 buses per hour and 240 buses per hour is due to increased real-estate/ commercial development to offset additional cost of development of multilevel car parking. The demand for multilevel car parking becomes feasible when it exceeds the minimum threshold of 120.

The hike observed at 180 buses per hour and 270 buses per hour; and 390 buses per hour for layover time 20 min and at 150 buses per hour and 180 buses per hour; and 240 buses per hour for layover time 30 min. Former two in both cases are attributed to increased real-estate/ commercial development to offset additional cost of development of multilevel car parking. The demand for multilevel car parking becomes feasible when it exceeds the minimum threshold of 120. The latter at 390 buses per hour for 20 min and 240 buses per hour for 30 min is attributed to increased real-estate/ commercial development to offset additional cost of development of multilevel car and bus parking. The demand for multilevel car and bus parking becomes feasible when it exceeds the minimum threshold of 120 and 130 respectively. The jump observed in layover time 40 min, 50 min and 60 min at 150, 120 and 90 buses per hour is due to increased real-estate/ commercial development to offset additional cost of development of multilevel car and bus parking (where applicable). The demand for multilevel car and bus parking becomes feasible when it exceeds the minimum threshold of 120 and 130 respectively.

1. Without Real estate Development, at grade Parking (Car & Bus).
2. With Real estate Development, at grade Parking (Car & Bus).
3. With Real Estate development, Multilevel (Ramp) Car and (At grade) Bus parking.
4. With Real Estate development, Multilevel (Mechanical) Car

5. With Real Estate development, Multilevel (Ramp) Car and Multilevel (Ramp) Bus parking
6. With Real Estate development, Multilevel (Mechanical) Car and Multilevel (Ramp) Bus parking
7. With Real estate Development, Basement Parking Car parking & at grade Bus Parking.

Financial Requirements

Bb

Typology	Local	B
Operation	Dynamic Bay	b

Terminal development Cost (including commercial)

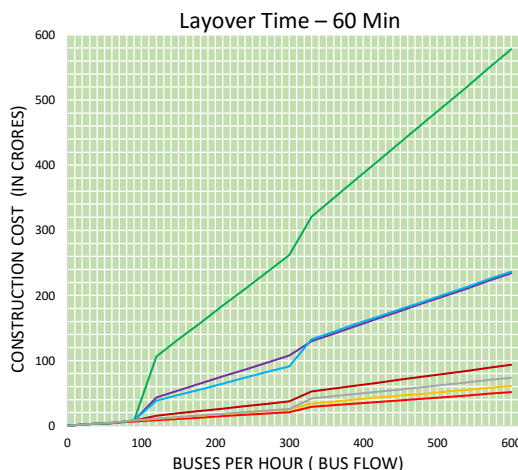
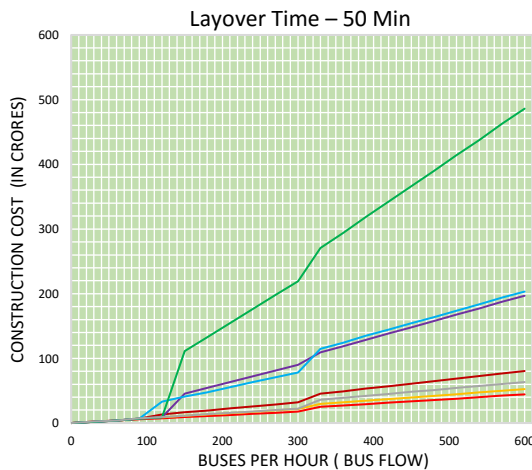
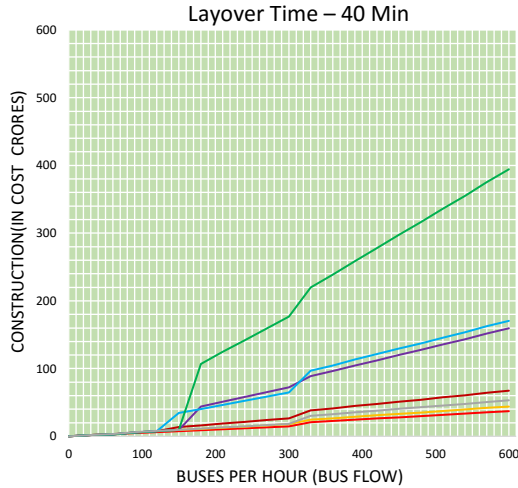
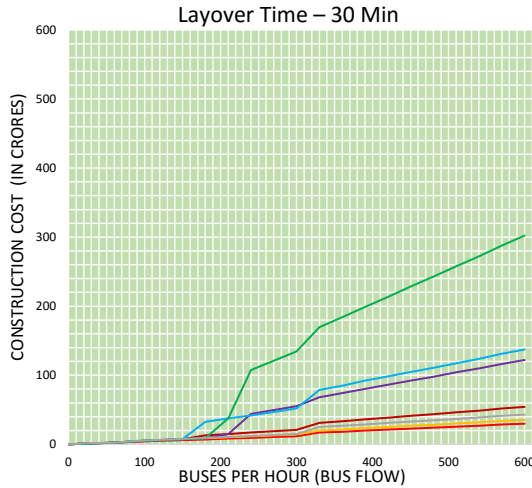
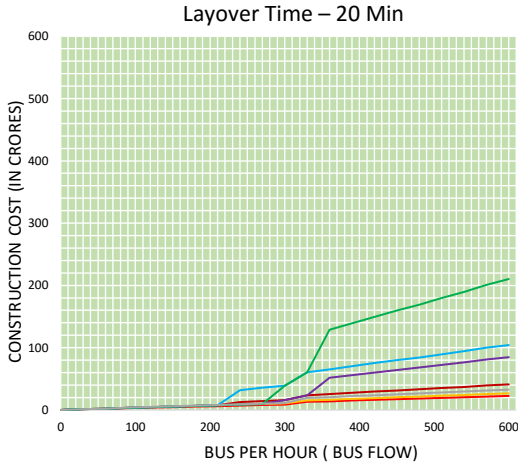
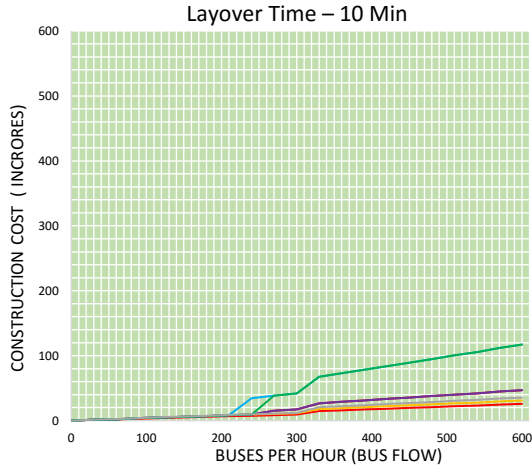

For layover time 10min, a jump is observed in construction cost at 210 buses per hour, and 240 buses per hour; and 300 buses per hour. For layover time 20 min, the jump is observed at 210 buses per hour and 270 buses per hour; and 330 buses per hour, for layover time 30 min, a jump is observed at 150 buses per hour and 180 buses per hour; and 210 buses per. Former two values in all cases attribute to increased real-estate/ commercial development to offset additional cost of development of multilevel car parking. The demand for multilevel car parking becomes feasible when it exceeds the minimum threshold of 120. The latter values at 300 buses per hour for 10 min, at 330 buses per hour for 20 min and 210 buses per hour for 30 min is attributed to increased real-estate/ commercial development to offset additional cost of development of multilevel bus parking. The demand for multilevel bus parking becomes feasible when it exceeds the minimum threshold of 130.

The jump observed in layover time 40 min, 50 min and 60 min at 150, 120 and 90 buses per hour is due to increased real-estate/ commercial development to offset additional cost of development of multilevel car and bus parking (where applicable). The demand for multilevel car and bus parking becomes feasible when it exceeds the minimum threshold of 120 and 130 respectively.

- 1. Without Real estate Development, at grade Parking (Car & Bus).
- 2. With Real estate Development, at grade Parking (Car & Bus).
- 3. With Real Estate development, Multilevel (Ramp) Car and (At grade) Bus parking.
- 4. With Real Estate development, Multilevel (Mechanical) Car

- 5. With Real Estate development, Multilevel (Ramp) Car and Multilevel (Ramp) Bus parking
- 6. With Real Estate development, Multilevel (Mechanical) Car and Multilevel (Ramp) Bus parking
- 7. With Real estate Development, Basement Parking Car parking & at grade Bus Parking.

Typology	Local	B
Operation	Dynamic Bay	b

Commercial Built-up area

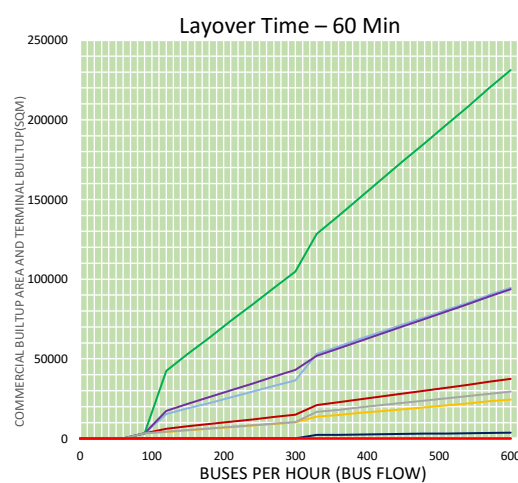
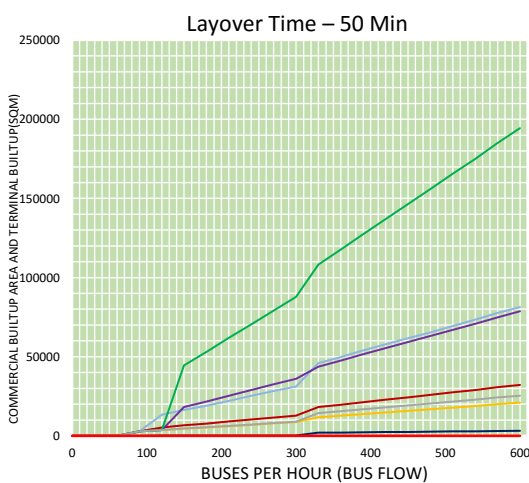
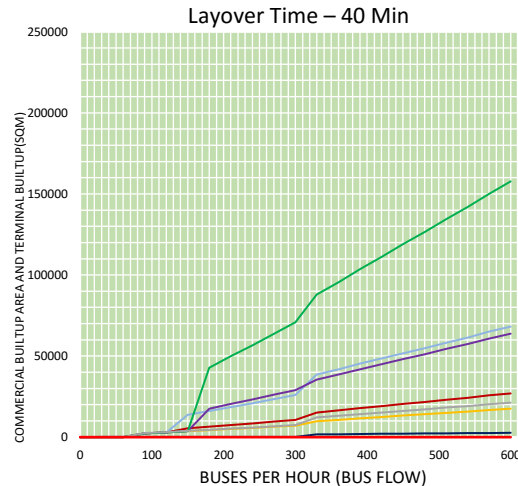
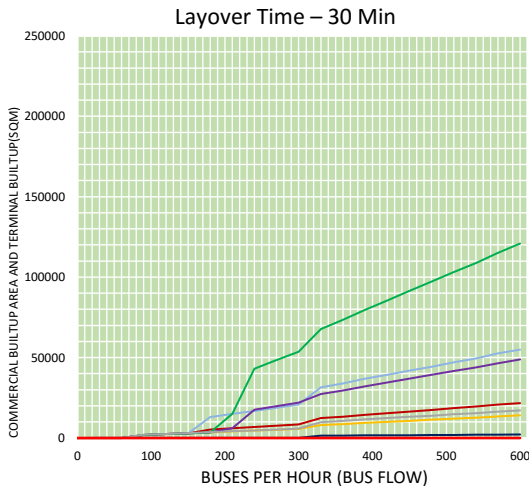
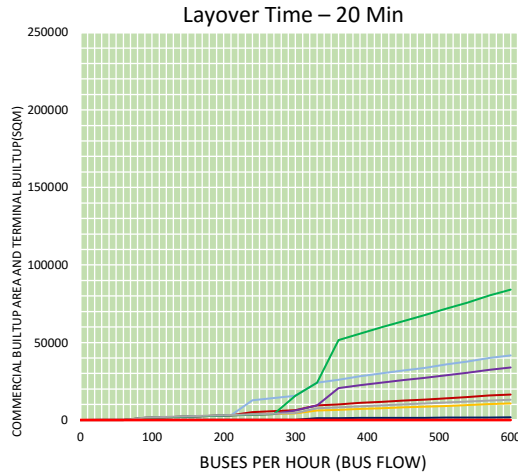
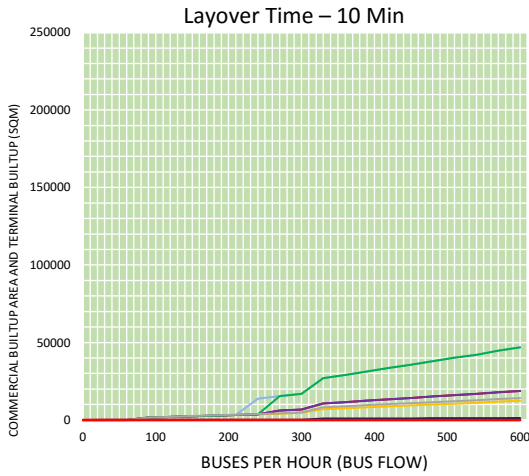

For layover time 10min, a jump is observed in construction cost at 210 buses per hour, and 240 buses per hour; and 300 buses per hour. For layover time 20 min, the jump is observed at 210 buses per hour and 270 buses per hour; and 330 buses per hour, for layover time 30 min, a jump is observed at 150 buses per hour and 180 buses per hour; and 210 buses per. Former two values in all cases attribute to increased real-estate/ commercial development to offset additional cost of development of multilevel car parking. The demand for multilevel car parking becomes feasible when it exceeds the minimum threshold of 120. The latter values at 300 buses per hour for 10 min, at 330 buses per hour for 20 min and 210 buses per hour for 30 min is attributed to increased real-estate/ commercial development to offset additional cost of development of multilevel bus parking. The demand for multilevel bus parking becomes feasible when it exceeds the minimum threshold of 130.

The jump observed in layover time 40 min, 50 min and 60 min at 150, 120 and 90 buses per hour is due to increased real-estate/ commercial development to offset additional cost of development of multilevel car and bus parking (where applicable). The demand for multilevel car and bus parking becomes feasible when it exceeds the minimum threshold of 120 and 130 respectively.

1. Without Real estate Development, at grade Parking (Car & Bus).
2. With Real estate Development, at grade Parking (Car & Bus).
3. With Real Estate development, Multilevel (Ramp) Car and (At grade) Bus parking.
4. With Real Estate development, Multilevel (Mechanical) Car

5. With Real Estate development, Multilevel (Ramp) Car and Multilevel (Ramp) Bus parking
6. With Real Estate development, Multilevel (Mechanical) Car and Multilevel (Ramp) Bus parking
7. With Real estate Development, Basement Parking Car parking & at grade Bus Parking.



6 Case Studies

6.1. City Bus Terminal Katyamanevili, Kalyan, Mumbai



Figure 26: Proposed site for Bus terminal



Figure 27: Proposed bus bays and Pedestrian infrastructure



Figure 28: Terminal Building Ground floor



Figure 29: Terminal building First floor

The Katyamanevili bus terminal is located in the north east region of Maharashtra's Thane district. It is part of Mumbai Metropolitan Region (MMR), and under the ambit of Kalyan Dombivli Municipal Corporation (KDMC), which operates bus transport services under Kalyan Dombivli Municipal Transport (KDMT). KDMC has a population of 12.46 lakh (2011 census). 62% of all trips within KDMC limits are catered by public transport operated by KDMT which caters to about 55,000 commuters every day

The Katyamanevili bus terminal is a Greenfield site (Figure 26). Selected by KDMC, it is classified under mixed land-use (MMR Planning Report). Located on the Pune Link Road connecting Badlapur with Kalyan, it has two approach roads and is adjacent to a residential tower on the south west side, and Maharashtra State Road Transport Corporation (MSRTC) depot on the east. Vithalwadi West railway station lies across the Pune Link Road towards the north of the site.

For the said bus terminal, two design options were proposed, based on client requirements, potential issues, and guideline recommendations. The first is an open-boundary bus terminal, and second a gated bus terminal complex. These have similar bus circulation plans and functional characteristics (for terminal, passengers and buses).

This guideline recommends 4163 sq. m. as minimum site area (without real estate development) for the assessed terminal requirements. The current site area is 5287 sq. m. The remaining 1124 sq. m. are proposed to be developed to support night time bus depot functions, and commercial real estate in order to raise funds for KDMC. Part of this area shall be developed as private vehicle parking to meet parking demand for the proposed real estate. 40 sq. m. of landscaped pedestrian plaza with informal vending spaces is also proposed (Figure 27).

The proposed terminal building is four storied. The ground floor of building (Figure 28) accommodates 131 sqm administrative office and accounts room (1), 50 sqm meeting room (2), 86.6 sqm toilets (3), 46 sqm driver restroom (4). Also 215 sqm service workshop with storage room and workshop manager room are proposed within the terminal site for both options (5). First floor (Figure 29) accommodates 184 sqm dining hall with kitchen for terminal staff and bus staff (1), and 46 sqm record room with store room (2) and 86.6 sqm toilets (3). Commercial space in option one totals 591 sqm and in options two, totals 265 sqm including toilets, lift and staircase. Additional Commercial real estate of 877 sqm and 577 sqm may be added for option one and two (as two additional floors) respectively, if additional parking space for private vehicles is available in close proximity. The current site can only accommodate 23 ECS.

Circulation in Bus terminal:

Bus: Fixed route bus operations for 60 buses per hour, with an average layover time of 10 mins are desired at this terminal. As per guidelines, this requires a total of 12 bus bays. For such operations, the recommended arrangement for small local terminal is drive through bay arrangement at 90 degrees. Raised pedestrian crossing connect all 12 bus bays in a series. This arrangement is proposed for both options.

In the open boundary (option one) approach, buses enter from the adjoining distributory road and turn 90 degrees into the bays (Figure 30). This allows open passenger circulation from all sides, and easy circulation for buses into their bays. Buses enter the bays, crossing a textured 2.0 m wide pedestrian walkway which levels with the road surface on the distributory road. This option is more space efficient.

In the gated approach (option two), buses enter from the site's left edge, and follow the same pattern (as option one) to enter into their respective bays (Figure 31). This requires more bus parking area, and narrows down the strip of land for real estate development.

Private vehicles and Feeder Modes: The required private vehicle and two wheeler parking for option one is 441 sq. m. and for option two, 286 sq. m., which accommodates 19 ECS and 12 ECS respectively. Circulation for, both private vehicles and feeder modes is presented in (Figure 32). Entrance and exit for private vehicle parking is from the same point. For feeder modes, three wheeled scooter rickshaw (TSR) parking bay is designed on the arterial road near the pedestrian plaza; it serves as drop off and pick up point for passengers.

Pedestrians: The three main users of a bus terminal are passengers, terminal staff, and bus staff. For the terminal under discussion, the passenger flow per hour is calculated to be 360 commuters, and passenger accumulation is expected to be 30 passengers (33 including visitors) during peak hour. Footfall being this low, the terminal is designed for basic amenities. These include toilet blocks, drinking water stations, and waiting platforms. In addition, 40 sq. m. of landscaped pedestrian plaza—with informal vending spaces—is proposed. Pedestrian circulation is presented in Figure 33.)

The raised cross walk ensures that the commuter area is clearly defined, and legible from buses and parking bays. It is at level with the external pavement; this is to avoid steps or ramps, and ensure barrier-free movement. Bollards visually segregate the passenger circulation area from the bus area, providing adequate visibility and safety for passengers.



Figure 30: Bus circulation (for option 1)



Figure 31: Bus circulation (for option 2)



Figure 32: Private vehicle and Feeder circulation



Figure 33: Pedestrian circulation in bus terminal

6.2. Inter State & Local Bus Terminal UKKADAM, COIMBATORE



Figure 34: Proposed site for Bus terminal



Figure 35: Area allocation for ISBT and Local terminal (Proposal 1)



Figure 36: Terminal Building Ground floor (Proposal 1)



Figure 37: Terminal Building First floor (Proposal 1)

The Ukkadam bus terminal is located in the southern part of Coimbatore. It serves Tamil Nadu State Transport Corporation (TNSTC) buses, Other Transport Corporations (OTC) buses, and private buses (including tourist buses). Additionally, the terminal hosts private mini buses, and night operations for buses plied by private operators and TNSTC

The Ukkadam bus terminal is a brownfield site (Figure 34). Selected by the Coimbatore City Municipal Corporation (CCMC), it is an ISBT with an integrated local bus terminal, and makes for a total site area of 11,452 sq. m. The terminal site is adjacent to a TNSTC depot, and sits at the edge of an existing natural lake named Periya Kulam. It also has a police station along the main entrance, and a multilevel housing complex on one edge.

When proposing functions for ISBT small terminal and local medium terminal, the site is treated as hybrid terminal type. It was agreed that two design options would be developed, differing in their bus parking's orientation within the terminal complex. Per the guidelines, both options require 8658 sq. m. for ISBT terminal functions, and 5304 sq. m. for local terminal functions. Since the site combines functions for both local bus terminal and ISBT (as per the guideline) 85% of the combined site area is required; which makes the total area requirement about 11,868 sq. m.

Proposal 1:

Both proposals include one-way circulation for both buses and private vehicles, with access from Palakkad Road and exit on Ukkadam-Sungam bypass road.

In option one, the function-wise area use of the site looks like this: 2942 sq. m. ISBT bus circulation, 2728 sq. m. local terminal bus circulation, 1589 sq. m. terminal building, 225.7 sq. m. for freight services, 364 sq. m. feeder service and private vehicle parking, 1147.3 sq. m. common vehicular circulation, and 2456 sq. m. passenger circulation.

The existing terminal building's ground floor is proposed to be expanded, and a first floor proposed, to accommodate more passenger functions. The ground floor (Figure 36) accommodates 660 sq. m. of administrative office and driver rest room area (1), concourse area of 281.1 sq. m. (2), 25 sq. m. of toilet block (3), and 329 sq. m. of commercial/retail space (4). The first floor (Figure 37) accommodates 301 sq. m. of railway reservation office (1), 304 sq. m. area for bank and post office (2), 25 sq. m. of toilet block (3), and 329 sq. m. of commercial/retail space (4). The existing cloak room is reoriented in the proposed terminal building block.

Circulation in Bus Terminal: Proposal 1

Bus: The proposed terminal is planned for bus flow of 45 buses per hour for ISBT functions, and 95 for city service. This is about 20% higher than current demand. Daily at the Ukkadam bus terminal, 201 buses make 712 interstate and inter-district trips (20 minutes' layover), and 273 local buses make 2273 trips (5 minutes' layover). Layover time is obtained from site observations and comparison with bus parking demand over five years.

In both proposals, ISBT involves dynamic bay allocation, and local terminal- fixed bay allocation. ISBT is provided 2, 7 and 11 bays for offloading, loading and idle parking respectively; local buses are provided 10 common bays. The bay alignment plan ensures that bus exhausts face away from the passenger boarding area.

Offloading bays for ISBT are provided close to feeder pick up lanes. For the bus orientation for offloading, saw-tooth bays are the best bet, as they facilitate easier bus docking, and maneuverability. After off-loading, buses shall park in the idle bays (given the average 20 min layover time), while passengers may access various feeder modes (from auto-rickshaw to local buses) (Figure 41). In this proposal, idle bus bays are provided parallel to Ukkadam-Sungam bypass road. As idle parking bays exclude passenger loading function, perpendicular bays ensure efficient spatial design. For small ISBT, perpendicular boarding bay arrangement is recommended, as they offer compact passenger loading options. Proposed bus circulation plan for Ukkadam terminal is presented in Figure 38.

For the medium-sized local bus terminal, the recommended bus parking orientation for loading passengers is the perpendicular drive-through arrangement, i.e. local bus bays are perpendicular to the Palakkad Road. This maintains the bus direction of movement, and the bus spends all of 5 minutes in its allotted bay, for parking, offloading and loading, before leaving the terminal site. Proposed local bus circulation for this option is presented in Figure 39. Total outdoor bus circulation area is 5298 sq. m.

Private vehicle and Freight Service: The total area provided for private vehicle parking is 246.5 sq. m. (accommodates 25.5 ECS). Entry for private and freight vehicles is from Palakkad Road through the service road (one-way circulation); exit for all the vehicles is common (from Ukkadam-Sungam bypass road). Overall private and freight vehicle circulation is presented in Figure 40.



Figure 38: ISBT Bus circulation (Proposal 1)



Figure 39: Local Bus circulation (Proposal 1)



Figure 40: Private vehicle and Freight service vehicle circulation (Proposal 1)



Figure 41: Feeder circulation (Proposal 1)



Figure 42: Pedestrian circulation (Proposal 1)



Figure 43: Area allocation for ISBT and Local terminal (Proposal 2)



Figure 44: Terminal Building Ground floor (Proposal 2)



Figure 45: Terminal Building First floor (Proposal 2)



Figure 46: Pedestrian infrastructure to access the terminal

Feeder Service: Feeder drop off/pick up bays are proposed near bus unloading bays on the service road (total 3 feeder bays for 20 vehicles). The circulation for Feeder system is presented in Figure 41.

Pedestrians: As per guidelines, this terminal is required to accommodate a total of 743 passengers and visitors for ISBT functions and 52 passenger and visitors for local bus terminal functions. Local bus bays with raised pedestrian crossing connect all passenger platforms in a series. The bollards visually segregate the passenger circulation area from the bus area. This provides adequate visibility and safety for passengers. The total outdoor passenger circulation is approximately 3576 sqm. The passenger circulation in bus terminal is presented in Figure 42. Pedestrian Plaza is proposed near Ukkadam-Sangham Bypass road and includes landscaped area, hawkers' space, seating areas, etc.

Proposal 2:

In option two, the site accommodates 2933 sqm for ISBT bus circulation, 2861 sqm for local terminal bus circulation, 1124 sqm for terminal building, 228.2 sqm for freight services, 450 sqm for feeder service and private vehicle parking and 1855 sqm for common vehicular circulation and 2001 sqm for passenger circulation area. (Figure 68)

The existing terminal building is expanded on ground floor and a first floor is added to accommodate more passenger functions. Ground floor of terminal building (Figure 44) accommodates 687 sqm of Administrative office and Driver rest room area (1), Concourse area of 257.6 sqm (2), 25 sqm Toilet block (3) and 329 sqm of existing commercial/retail space (4). While the First floor (Figure 45) accommodates 183 sqm of Railway reservation office (3), 45 sqm area for post office (2), 25 sqm of Toilet block (4) and 329 sqm of Commercial/retail space (1).

Circulation in Bus Terminal: Proposal 2

Bus: For ISBT terminal, the offloading bays are provided close to the feeder pick up lanes. The best orientation for buses for alighting passengers is saw-tooth bays as it aids in easier bus docking, and maneuverability. After off-loading, the bus shall park in the idle bays (as layover time for ISBT buses is 20 min) while passengers can access variety of feeder vehicles from auto-rickshaw or local bus (Figure 50). In proposal two, the idle and loading bays are parallel to Palakkad Road. And, as idle parking bays do not carry passenger load, perpendicular bays ensure efficient spatial design, allowing more space for other functions. For Small ISBT terminal, perpendicular boarding bay arrangement is recommended as they offer compact passenger loading options. ISBT bus circulation is presented in Figure 47.

For medium sized local bus terminal, perpendicular arrangement of bus parking for loading passengers

is recommended (i.e. the local bus bays are parallel to the Palakkad Road). Therefore, the buses turn right angles after entering the site to enter their respective bus bays and the bus parks in its allocated bay to alight and load new passengers all within 5 minutes and leaves the site. Overall bus circulation is presented in Figure 48 for Local buses. The total outdoor bus circulation area is 6464 sqm.

Private vehicle and Freight Service: Total area provided for private vehicle parking is 221.5 sqm (accommodate 23.5 ECS). The entry point for private vehicles and freight vehicles is from Palakkad road through the service road (one way circulation) and the exit for the same is same for all vehicles from Ukkadam-Sungam Bypass road. Private vehicle and freight circulation is presented in Figure 49.

Feeder Modes: The feeder drop off/pick up bay (total 1 feeder bay for 18 vehicles) is proposed near bus unloading bays on the Palakkad road (outer edge of terminal). The circulation for Feeder system is presented in Figure 50.

Pedestrians: As per the guidelines this terminal is required to accommodate a total of 743 passengers and visitors for ISBT functions and 52 passenger and visitors for local bus terminal functions. Local bus bays with raised pedestrian crossing connect all passenger platforms in a series. The bollards visually segregate the passenger circulation area from the bus area. This provides adequate visibility and safety for passengers. The total outdoor passenger circulation area is approximately 3043 sqm. Passenger circulation in bus terminal is presented in Figure 51. Pedestrian Plaza is proposed near Ukkada-Sangham Bypass road includes landscaped area, hawker space, seating areas, etc. Between the two proposals, the bus and passenger ingress and egress to site vary only marginally, but the bus parking area and freight services are significantly different. The bus bay numbers and passenger functions are common in both designs.



Figure 47: ISBT Bus circulation (Proposal 2)



Figure 48: Local Bus circulation (Proposal 2)



Figure 49: Private vehicle circulation (Proposal 2)



Figure 50: Feeder circulation (Proposal 2)



Figure 51: Pedestrian circulation (Proposal 2)

6.3. City Bus Terminal Uttam Nagar, Delhi

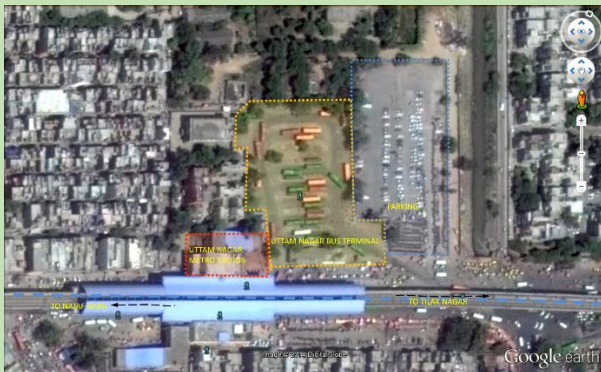

Figure 52: Proposed site for Bus terminal

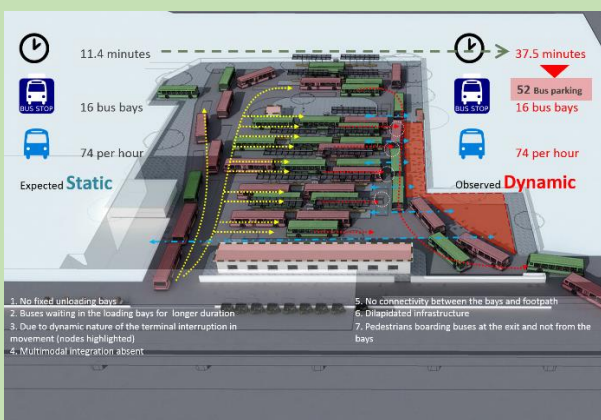

Figure 53: Existing terminal circulation



Figure 54: Area allocation & Bus circulation in terminal (Proposal 1)



Figure 55: Proposed commercial area (Proposal 1)

The 2.3 acre Uttam Nagar terminal site (Figure 52) is located on Najafgarh Road adjacent to Uttam Nagar East metro station, in Delhi. This local/intra city inter-modal bus terminal is managed by Delhi Transport Corporation (DTC). It is centrally located and abuts mixed land; the metro occupies 0.3 of the site's 2.3 acres. 1520 buses, on 33 routes, pass the terminal daily.

The bus terminal components (Figure 53) include 16 fixed route bus bays on 30 m long 3 m wide platforms; existing vehicular parking, bus terminal office, the Uttam Nagar metro station, one toilet block, informal parking of feeder modes (such as cycle rickshaw, Gramin Seva, and auto rickshaw).

Uttam Nagar terminal is served by two public bus operators: DTC and DIMTS (cluster buses). Commuters can access the site from three entrances, including one from the private vehicle parking. Feeder mode parking is located outside the site, in the service lane, along the main road (Figure 53). This terminal currently includes a toilet for drivers and passengers, maintained and operated by Sulabh International, and operated as pay-per-use.

This terminal's primary concern has to do with the high number of bus stacking i.e. 52, which is almost 4 times the number of bays provided for them. The terminal is overcrowded by buses not due to increased demand, but high layover time (averaging 37.5 mins), close to four times the intended/planned time.

To solve the issue, two options for the terminal's upgradation are proposed: static bus bay terminal system and dynamic bus bay terminal system.

Proposal 1: Static bus bay terminal

For the situation where layover time has been corrected to planned 10 mins, static bus bay operations are proposed. This is based on dedicated bus bay allocation. Each route (originating or terminating) has a designated common bay for loading, unloading and idle parking function (Figure 54).

The terminal's northern edge is proposed to be developed as a commuter area; it includes pass office (34 sq. m.), public toilets (51 sq. m.), ATM (10 sq. m.), food kiosks (27 sq. m.), and police booth (17 sq. m.). The area between this commuter block and the service road shall be developed as an open landscaped court (315 sq. m.), with provision for hawking/vending spaces. Above the commuter block, a commercial estate with up to three floors may be developed as retail/office space with a total area of about 1472 sq. m. (Figure 55).

The large central area (2000 sq. m.) is proposed to include 18 parallel static bus bays, each 2.25 m wide (with 3.0 m wide bus lane) and 14 m in length, meant to serve as a common bay for idle parking, de-boarding and boarding, for a specific route. Access to these bays is through a single 5 m wide barrier-free pedestrian path.

The terminal area shall not include a boundary wall on the edge of Najafgarh Road. It is proposed to be segregated from the service lane through a 5 m wide barrier-free pedestrian path (developed within the terminal site), which will link the metro station entrance and the current metro parking. It will also connect (branching perpendicular to this path) to the bus bay access path (Figure 56).

Proposal 2: Dynamic bus bay Terminal

If the planning must suit a layover time of 37.5 mins, dynamic bus bay allocation is proposed. A 4060 sq. m. bus parking area with 52 idle parking bays, is planned on the site’s southern half (adjacent to the metro entrance block). The northern half shall be divided into front and back portions. The back shall include a small workshop with four bus parking bays (buses requiring repair), and space for providing staff parking for six bicycles and six two wheelers. The front shall include a single floor building complex, which will house administrative offices including terminal office with pass section (131 sq. m.), toilets for bus and terminal staff (48 sq. m.), rest room and canteen/pantry for bus staff (162 sq. m.), public toilets (51.3 sq. m.), ATM (16.9 sq. m.), and police booth (16.9 sq. m.). In this option, 115 staff members (including bus staff) are expected to be accommodated in the terminal at any point (Figure 57).

The terminal area shall not include a boundary wall facing the Najafgarh Road. It is proposed to be segregated from the service road by an internal (one way) bus access road, for exiting buses. The area between the access road and the proposed single storied office building (14.7 m wide and 643 sq. m. in area) is proposed to be developed as a passenger boarding court. The existing administrative office block is proposed to be dismantled, for a barrier free 7 m wide pedestrian walkway connecting the three boarding platforms (dynamic passenger loading bays) with the metro entrance (Figure 59). The bus entrance leads directly to the bus parking; entering buses shall offload passengers at curb side off-loading bays before parking (in idle parking bays). Then, the bus staff proceeds to the rest rooms/canteen in the administrative office complex, accessible directly from the parking (Figure 57).

Above the north half of the site, a commercial estate up to two and a half floors may be developed, generating about 4000 sq. m. of prime real estate (Figure 58).



Figure 56: Dedicated Loading Bays for Buses (Proposal 1)



Figure 57: Area allocation & Bus circulation in terminal (Proposal 2)



Figure 58: Proposed commercial area (Proposal 2)



Figure 59: Aerial view of Proposal 2: Dynamic Operations in Terminal



Figure 60: Fixed bus bays (Proposal 2)

6.4. Inter State Bus Terminal CHANDIGARH



Figure 61: Bus terminal Site context



Figure 62: Components of existing terminal

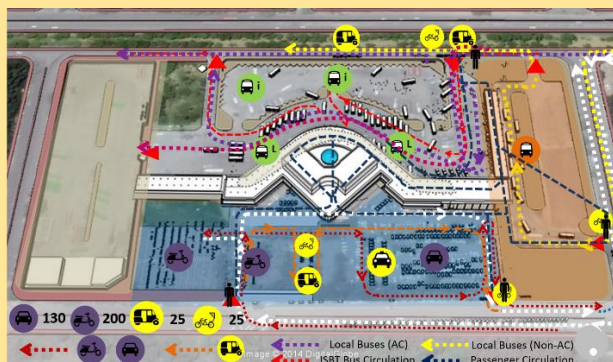

Figure 63: Circulation in existing terminal

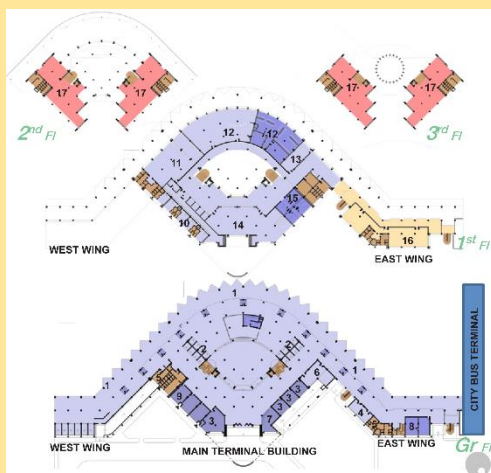

Figure 64: Existing floor plan

Sector 43 ISBT was recently developed on a 21-acre site in south-east Chandigarh, between junctions 58 and 59 on Vikas Marg. As presented in Figure 61, the site is adjacent to District Court Complex and near Judicial Academy, opposite Kajheri Village.

The terminal provides interstate bus connections for Punjab, Haryana, Uttarakhand, Himachal Pradesh, and Jammu and Kashmir; and intra-city as well as sub-urban connections. Bus services include A/C and non A/C services for inter-city and sub-urban routes. Currently, the terminal serves over 80,000 passenger trips per day with an average occupancy of 45 per bus.

The existing terminal premises comprise five sections (Figure 62). Passenger volume during peak operation hours is estimated at 8,000, based on average passenger stay duration at 20 mins. Daily, buses ply over approximately 91 routes (37 long, 47 local, 7 sub-urban). On average, 2 buses enter the terminal premises per minute, i.e. 120 per hour. The average bus frequency is 3-5 mins, average idle bus parking 20 mins, average offloading time 1 min, and average loading time 6 mins.

Vehicular circulation in the terminal is presented in Figure 63. For ISBT buses, entry and exit to the terminal is from Vikas marg. Evaluation of present operations shows that due to lack of designated unloading bays, drivers park and unload randomly within the bus parking area and main carriageway. Additionally, city buses also access the interstate bus zone to offload passengers, and to access the local bus depot. This creates bus-pedestrian circulation conflicts, rendering the terminal inefficient and risky. This also creates an ambiguous bus movement resulting in chaotic circulation.

Vehicular parking can be accessed from the arterial road along the terminal site's periphery. It comprises 25 auto-rickshaw parking, 130 car parking (including taxi), 200 two-wheeler parking, and can accommodate up to 355 vehicles (ECS) at a time (Figure 63).

The terminal building comprises four floors (Figure 64) with built-up area of over 8,500 sq. m. (excluding the currently-vacant basement parking for two-wheelers). The ground floor houses 11 reservation counters, 28 loading bays, shops, tourism offices, cloak room, and basic amenities like toilets and drinking water. It also includes facilities like a restaurant, Chandigarh Transport Undertaking (CTU) office, information, police assistance counter etc. (Figure 64).

The first floor houses a commuter lodge, consisting of five rest rooms with attached toilets, and a dormitory with dining hall and kitchen. It also accommodates a post office, railway reservation office, and five tourist offices. In the first floor's east wing, drivers and conductors have been provided rest rooms, drinking water, and toi-

lets (Figure 64). The second and third floors are designated for commercial activity, including pantry and toilets (Figure 64).

Three main issues that best define problems phased by Sector 43 ISBT are: operations are accessibility (circulation), spatial utilization, and infrastructure.

Proposals:

Two options are proposed for redeveloping and improving the Sector 43 terminal. These are based on static and dynamic bay arrangement, and differ only in number and arrangement of loading bays and idle parking at the terminal.

The private vehicle parking is proposed to be segregated into three zones (Figure 65). One would be for passengers and visitors (capacity of 330 motorized two wheelers, 181 cars and 68 bicycles). The parking opposite the proposed commercial block is in two levels: ground level parking for terminal staff (planned capacity of 118 cars and 79 two wheelers), and basement level parking for commercial/office blocks (108 cars and 40 two wheelers). Basement level parking bays may fetch additional lease premium for CTU.

Spatial re-organization and infrastructure improvements at the Sector 43 ISBT are proposed with the aim to facilitate improved and efficient bus and passenger circulation. Resolving conflicts and other circulation related issues is key to overall improvement at the terminal.

Internal ISBT bus circulation is planned with static bay (as proposal 1) and dynamic bay allocation (as proposal 2). Both options are planned for streamlined bus and passenger circulation in order to improve efficiency and remove conflicts. Local bus terminal (A/C bus) bays within the ISBT area are proposed to be used by inter-state buses for de-boarding of passengers. Such off-loading bays are missing in the current infrastructure.

Additionally, the depot's entrance gate is proposed to be shifted to the opposite edge (adjoining the external road) in order to allow access from the main road rather than from the ISBT parking area. This eliminates ingress of local buses on the ISBT internal circulatory path.



Figure 65: Proposed depot, Local terminal area and Private parking area (same for both proposals)

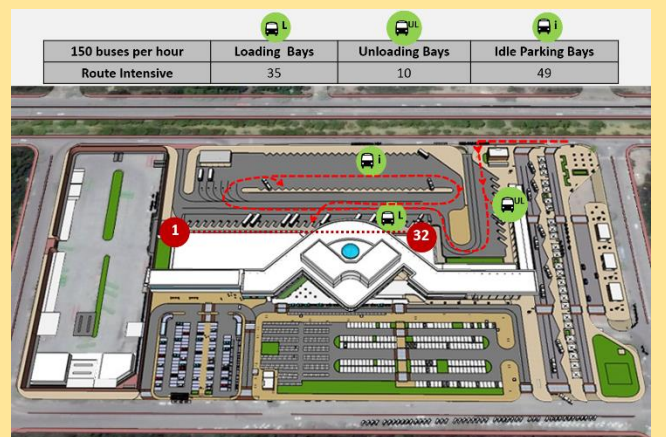

Figure 66: ISBT bus circulation for proposal 1

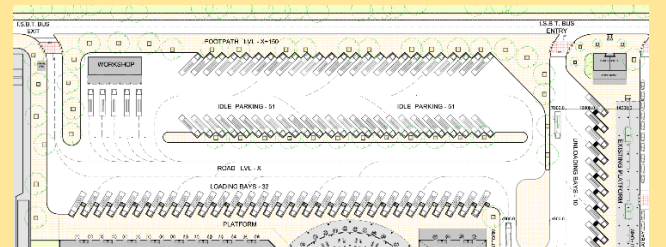

Figure 67: ISBT bus circulation with Fixed bus bays (Proposal 1)

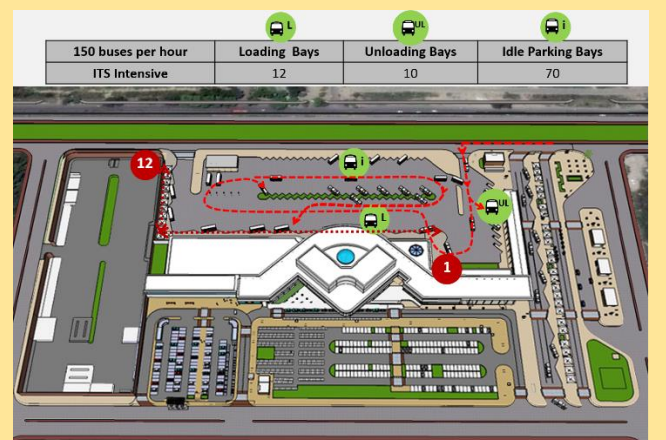

Figure 68: ISBT bus circulation for proposal 2

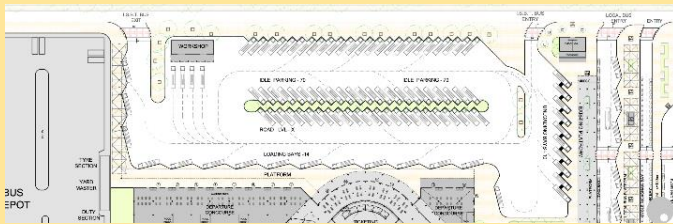

Figure 69: ISBT bus circulation with Dynamic bus bays (Proposal 2)

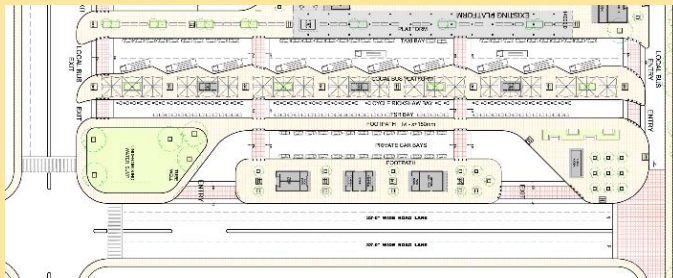

Figure 70: Proposed Local bus terminal

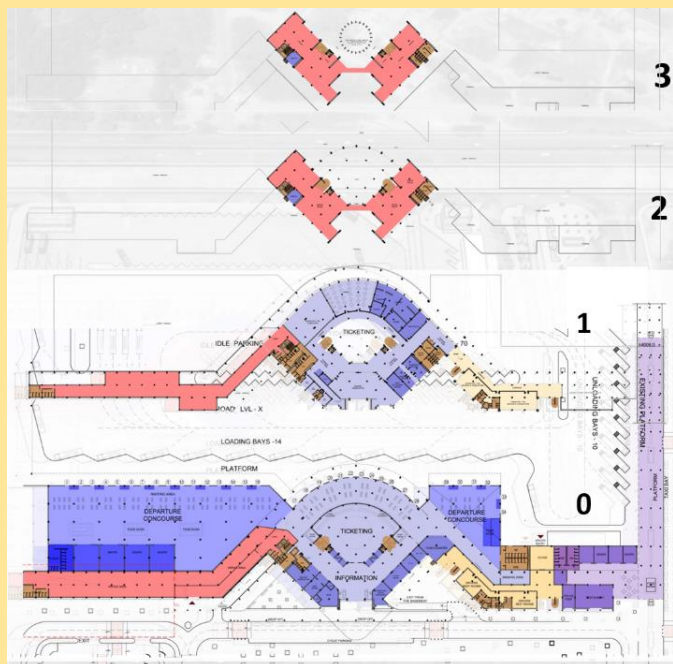

Figure 71: Proposed floor plans of Terminal building (for both proposals)



Figure 72: Loading bus bays for ISBT buses

After entering the terminal, buses access off-loading bays. Once passengers are offloaded, buses shall go to the idle parking bays and park there till their departure time. 6 to 7 minutes before departure time, they leave the idle parking bays and dock at the loading bays. Expected time for loading is 6 minutes.

A small workshop shed with a capacity to cater to 4 to 5 buses, is proposed to be developed within the bus idle parking area for minor repair and maintenance of interstate buses (Figure 69).

Parallel bays have been planned for pick up by taxi, bus, cycle rickshaw, auto rickshaw, and private vehicle (in this order) from the proposed arrival concourse, adjacent to the proposed interstate bus arrival bays. To eliminate conflicts, circulation for these bays is through three parallel lanes, separated by passenger waiting areas. This circulation is redesigned as north to south as against the current south to north movement. The pick-up zone at the terminal is planned for 10 saw tooth bays for local buses, and parallel bays for 35 taxis, 55 auto rickshaws, 57 cycle rickshaws, and 30 private cars/ two wheelers as presented in Figure 70.

The provision of separate passenger departure and arrival concourses with controlled access is intended to streamline passenger circulation (Figure 71). The passenger arrival concourse (10 m wide) faces feeder vehicle circulation. Arriving passengers only need walk across it, to access waiting vehicles on pick up bays (along pick up lanes) accessible by three safe, raised crossings. Thus, arriving passengers depart the terminal without mixing with departing passengers or other visitors.

Dedicated short haul bus driver and staff zone has been proposed at the ground floor, with small pantry, resting room, washrooms, and access from the bus parking. This zone is segregated from passenger area and is connected directly to first floor dormitories for use by overnight halting staff (Figure 71).





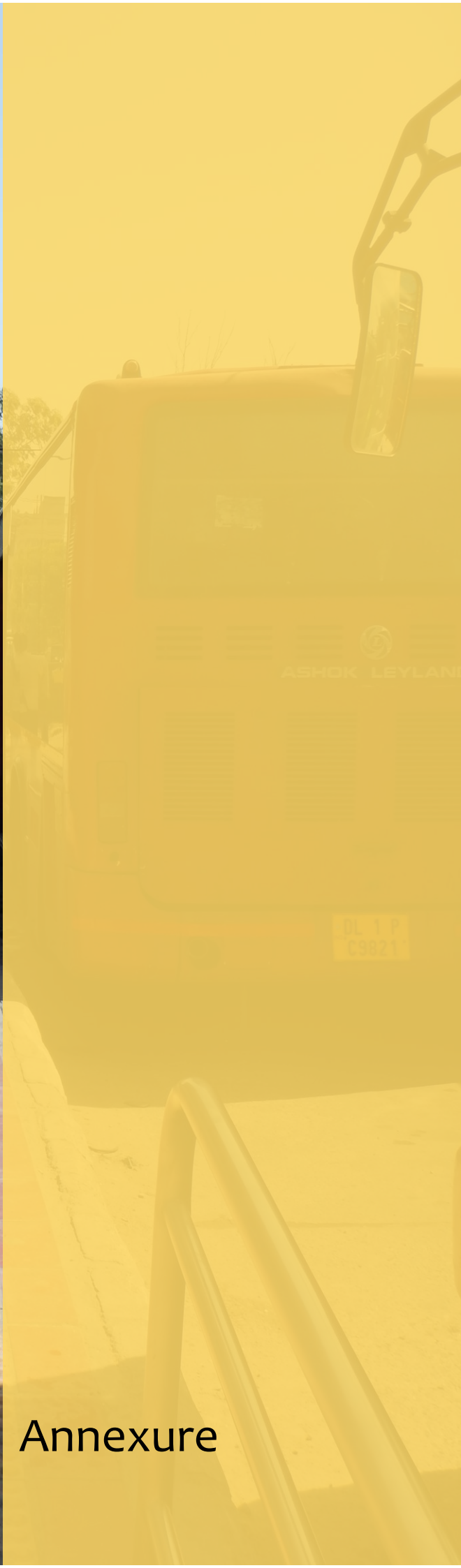

It is proposed that the current passenger departure corridor (adjacent to depot) be developed as a commercial office space to be leased to eligible organizations/corporates. This adds 2000 sq. m. of commercial space to the current 1592 sq. m. of commercial space on the second and third floors of the main building (Figure 71-peach color), and provides dedicated access to this area.

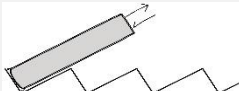

For safe, direct and convenient pedestrian access to the complex, a barrier-free pedestrian only access is proposed. This access would be through a 4-6 m wide pedestrian walkway connecting the sector road to the new commercial block entrance porch as well as the terminal entrance (with raised crossings across roadways).

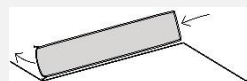

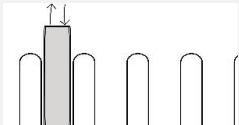
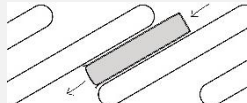

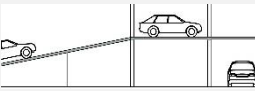
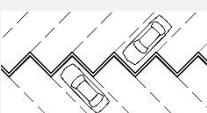
Annexure

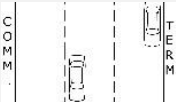

Annexure 1 - Planning Information and Considerations

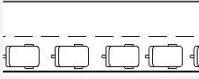
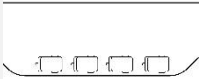







Word	Typology	Description/Consideration	Symbol/Explanation
Function	ISBT	Inter State Bus Terminal	A
	Local	Local City Bus Terminal	B
Operation	Fixed Bay Allocation	Loading, Idle and Unloading operations taking place at same bay	a
	Dynamic Bay Allocation	Loading, Idle and Unloading operations taking place at different bays	b
Terminal Size	Small Type	Peak Bus flow per hour is less than 60	1
	Medium Type	Peak Bus Flow per hour is between 60 and 300	2
	Large Type	Peak Bus Flow per hour is greater than 300	3
Bay type	Common bays	Loading, Idle and Unloading operations taking place at same bay	
	Segregated bays	Loading, Idle and Unloading operations taking place at different bays	
Bus boarding Bay Type	Saw tooth bays	Bays arranged in saw-tooth fashion	
	Angular bays	Bays aligned parallel to 60, 45 and 30 degrees	
	Perpendicular bays	Bays aligned parallel to 90 degrees	
	Drive through	Bays arranged parallel at either 90, 60, 45, 30 degree with preferably an overtaking lane with each in case of stacked bays	
	Linear/parallel bays	Bays arranged linearly along the departure platform	
Private Vehicle Parking	Structured	Multilevel Parking with or without mechanical lifts	
	At Grade	On hard surface or ground	



	Shared	Multilevel or at grade parking provision is combined with miscellaneous activities around the site	
	On-Street	Side or shoulder parking either charged or free	









Feeder Service Integration		Bus, Taxi, Cycle or Auto Rickshaw	
	Intermodal	Provision for feeder bays within or adjacent to the site as per requirement	
	Lanes	Provision for feeder service along demarcated lanes	
	Bays	Feeder service allocated as per segregated bays	

Finance	PPP	Public-Private Partnership	
	Private Ownership	Private ownership	

Bus Maintenance Facility	On-site	Breakdown, repair operations provided within the site	
	Off-Site	Breakdown, repair operations available outside the site	

Passenger Amenities	Concourse	
	Eateries	
	Cloak Room	
	Dormitory (for night operations)	
	Ticketing	
	Information	
	Drinking Water	
	Toilets	

Terminal Staff Amenities	Revenue Office	
	Terminal Office	

	Resting room	
	Canteen	
	Drinking Water	
	Toilets	
Bus Staff Amenities	Dormitories (for night operations)	
	Resting Room	
	Canteen	
	Drinking Water	
	Toilets	

Annexure 2 - Glossary of Terms

Term	Definition/Explanation	Reference In-terim Report
Accessibility	Ease of using the terminal function expressed in time and/or cost and/or effort	
Arbitration	Process of dispute settling by means of third party or arbitrator	
Automatic Fare Collection System (AFC)	Correct deposit of coins or token or scan of fare card for payment for use of transport mode which may require installation of special equipment for counting and revenue collection	
Auto Rickshaw	three-wheeler fuel/gas engine-vehicle used as public taxi; also called Autos	
Automatic Vehicle Location System (AVLS)	System technology that tracks real time location of fleet vehicles for dispatching, maintaining schedules, answering customer inquiries, etc	
Base Period	Off peak period that is between the morning and evening peak period	
Bus	Manually steered fuel vehicle with large passenger capacity. The types include hybrid, articulated, charter, circulator, double decker, feeder, intercity, medium size, standard size, and mini-bus	
Bus, Articulated	55ft or more in length with flexible separation in between the two compartments	
Bus, Charter	Reserved service under agreed contract and agreed price serving a common purpose for passengers on a regular schedule	
Bus, Circulator	Bus serving a confined area with major traffic corridor connections, preferably with one stop terminal operations	
Bus, Double Decker	Double storey compartment for passengers	
Bus, Express	Express service between limited stops or no stops except for origin and destination	
Bus Fare	Amount paid for one adult for one transit ride excluding bus transfer, zone charges, surcharges and reduced fares	
Bus, Feeder	A ancillary service to pick or drop passengers between terminal and remote stops	
Bus, Intercity	Front door bus with rear-high seating arrangement and with luggage compartment usually for long distance route	
Bus, Medium-size	Dimension of bus range from 29 to 34 ft in length	
Bus, Small	Dimension of bus is less than or equal to 28 ft in length	
Bus, Standard size	Dimension of bus range from 35 to 41 ft in length	
Bus, Transit	Bus with centre and front door, usually with rear engine, low rear-seating and with no luggage compartment or restroom facilities for use in frequent-stop service	
Bus Bay	Platform designated adjacent to bus parking for ease of access	
Bus Lane	Dedicated street or lane for bus service on routinely basis; may be combined with carpool lanes per traffic demand and requirement	
Bus Shelter	Structure in which people wait safely at a bus stop	
Bus Stop	Area where people can board or alight from the bus identifiable by a signage	
Bus Station	Routes primarily originate or terminate here with basic amenities provision for passengers	2.1.1
Bus Terminal or Interchange	Bus originated or terminates and/or serves passing routes with provision for significant amenities as passengers spend longer durations	2
Bus Recovery	Same as Layover time	2.1.1
Capacity	Maximum vehicular flow at a given point on a traffic lane or carriageway per unit time under certain conditions	
Capital Cost	Cost of long term asset such as property, building, automobiles, etc	
Centrality	Terminal as a point of origin or destination of traffic for maximum functional generation and attraction	2.3.1

Cloak Room	Area where passengers can safely leave their luggage for short span of time	
Commuter	Person who travels regularly between home, work and/or school	
Compressed Natural Gas (CNG)	Alternative fuel	
Concourse	Designated Passenger area with amenities and facilities like waiting hall, cloak room, toilets, etc	
Conflict	Situation where the confluence or intersection of different traffic may lead to mutual impediment or even traffic accidents	
Contraflow Lane	Demarcated lane reserved for buses opposite to the direction of traffic flow on the other lane	
Corridor	Demarcated lane reserved for connecting two major points with one general directional flow and may stretch out on streets, highways and transit route alignments	
Crossing	Part of carriageway for crossing, indicated by road marking in a transverse direction	
Cycle Rickshaw	Tri-cycle with big seating resting on two wheels and driver manually pedalling to transport people	
Dial-A-Ride	Demand responsive service using feeder facility to pick up or drop off passengers at pre-arranged times at specific location within the service radius	
Dwell Time	Time taken after unloading and before boarding passengers including door opening and closing durations	
Eateries	Food restaurant/café/lounge	
Fare Structure	System to determine the payment amount for various passengers using a transit mode at a given time	
Feeder Mode	Auxiliary mode of travel before or after the bus trip	
Fixed route	Loading, Idle and Unloading operations taking place at same bay	
Freight	Heavy luggage or parcel	
Dynamic route	Loading, Idle and Unloading operations taking place at different bays	
Hawking zone	Area for non-legal small scale commercial sellers to sell directly to people	
High Occupancy Vehicle (HOV)	Vehicles that can accommodate 2 or more than 2 persons like a bus, a van and/or carpool	
Intermediacy	Terminal as an intermediate point in traffic flow	2.3.1
Intermodal	Activities and/or issues involving more than one mode of transportation including connections, options, cooperation and coordination of various modes	
ITS	Intelligent transportation system includes digital screen boards and wayfinding information	
Kiss and Ride	Drop off area for commuters to board public transport mode	
Layover Time	Average scheduled time taken by bus after entering the terminal complex till departure including recovery of delays and preparation for next trip	Layover Time
LOS	Level of service with ancillary functions such as shops, educational facility, healthcare, cultural activities, etc are provided at an acceptable cost	
Modal Split	Term to describe distribution of passengers using alternative transportation forms like private vehicle versus percentage of public transport users	
Multimodal	Same as intermodal	
Occupancy	Strength of passengers accommodated at one time	
Off Peak Period	When travel activity is low with lower frequency of service than usual	
One-stop	Circulatory trip in one direction only	2.1.4
Originating traffic	Traffic that starts in the concerned area	
Destination Traffic	Traffic that has final destination in the concerned area	
Para transit	Comparable transit service required by Americans with Disabilities Act (ADA) of 1990 for differently-abled passengers	

Park and Ride	Designated parking lot (see Transfer station) for vehicles at terminals to continue journey using transit mode from those locations	
Peak period	Morning and evening duration with heavy passenger volume	
PIS	Digital or manual passenger information system. It is a part of ITS	
Public Transit System	Organization that provides transportation services owned, operated or subsidized by any authority/municipality, country or other government agency including those operated and managed by private management firm under contract to the govt agency owner	
Public transportation	Publicly or privately owned transportation for public on regular basis; synonyms with 'mass transportation', 'mass transit' and 'transit'	
Ridership	Number of rides by people using public transportation in a stipulated amount of time	
Route	Defined movement for one trip	
Signage	Signboard conveying directional or caution or warning information largely through graphics	
Through Traffic	Traffic with no origination or destination in particular area	
Transit System	Public or private organization providing local or regional multi-occupancy-vehicle passenger service either solely or under contract with another agency	
Trip	bus originating and terminating at one or two different points	
Two-stop	Trip either requires reverse movement or origin is different than terminating point	2.1.4
Two-wheeler	Referred to cycle or motorbike	
Terminal, Central	Terminal located in the city core or centrally within city limits	2.3.1.1
Terminal, Far Side	Terminals located in the peripheral areas of the city	2.3.1.2
Terminal, Inter-City	Operating between cities within state limit	2.1.2
Terminal, Intra-City	Operating within city limits	2.1.2
Terminal, Inter-state	Operating between 2 or more states	2.1.2
Terminal , Inter-modal	Integrated with different public transport modes	2.1.1
Terminal, Minor	Bus stops used for few or one route	2.1.2
Traffic flow	Number of traffic units passing a given point over a fixed period of time; referred to passenger or vehicle volume	
Traffic Lane	Carriageway defined by road markings to comfortably accommodate a single line of traffic designated for its use	
Transfer station	Provision for parking private vehicles to enable passengers to transfer to public transport	
Zone Fares	System of fares divided into zones with specific rates	

Annexure 3 - Specific Design Considerations for Bus Terminals

1. Follow the setback requirements of Institutional Building to enable firefighting services and other emergency infrastructure to be installed in place.
2. Design with minimum Bus and pedestrian conflicts
3. Keep circulation of passengers clear from Bus Area and Vehicular parking to provide safe transition for passengers and visitors
4. Kiss-n-ride and Park-n-ride services should be accommodated in the drop-off and pick-up design to avoid accumulating cars within site.
5. Avoid bus ingress and egress points at junctions. They should be at a minimum of 35 m away.
6. Perpendicular parking is preferred for idle parking in all cases and Saw-tooth is preferred for alighting passengers in the terminals. bus
7. Contextual analysis should include cultural and social sensitivity for the design project.
8. Enhance Non-Motorized Transport or NMT as Feeder Services.
9. Encourage use of sustainable energy systems for terminal design.
10. Bus Exhaust should be away from the passenger boarding areas.
11. Minimum bus bay width should not be less than 1.5 m.
12. Design should be sensitive towards Differently-able commuters and visitors. Provide basic amenities like toilet and drinking water facilities.
13. Avoid levels within the terminal building complex.
14. Provide barrier free environment.
15. There should be planning transparency within the complex to discourage anti-social activities.
16. Freight Services is taken under Ancillary Functions. They may require Baggage Trolleys or Fork Lift according to scale of the design requirement.
17. Hawker Zone is included in local Terminal's open area.
18. Heavy landscaping along the site boundary should be designed to reduce noise pollution.
19. ITS and/or PIS system should be integrated for prompt communication between terminal operators and commuters.
20. All signages should include at least one official language- English or Hindi with standard graphics.
21. Adequate lighting should be maintained within the complex at all times.

References for Guideline

APTA (1994). Glossary of Transit Terminology. Published by American Public Transit Association at 1201 New York Avenue, NW, Washington DC 20005

ASVV (1998). Recommendations for traffic provisions in built-up areas. Published by CROW at PO BOX 37, NL-6710 BA Ede, The Netherlands

Annexure 4 - Spatial Requirement Charts for Bus Terminals

Spatial Requirements

Aa

Typology	Inter State	A
Operation	Fixed Route Bay	a

Site Area Requirement

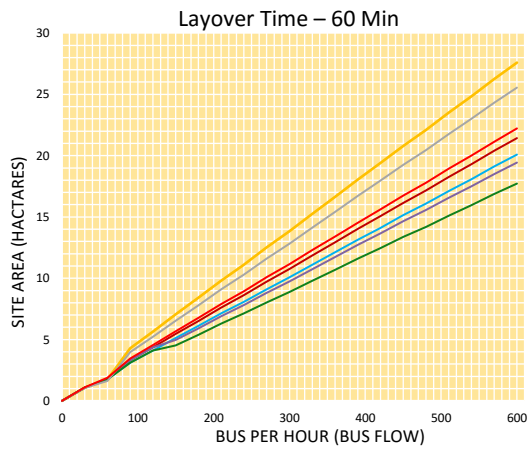
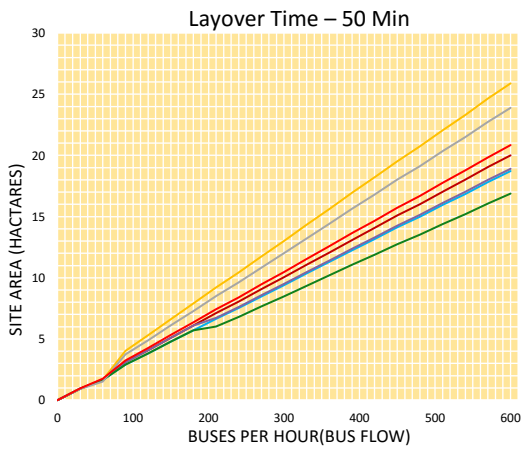
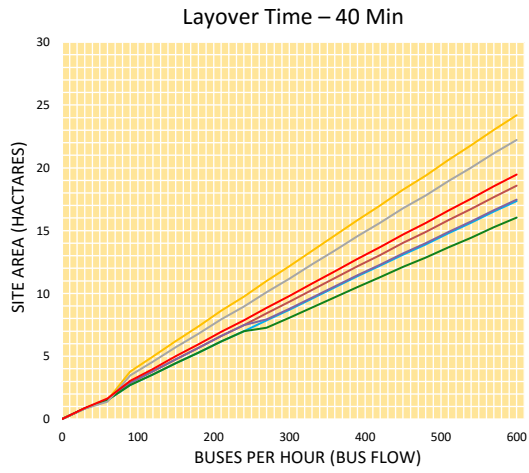
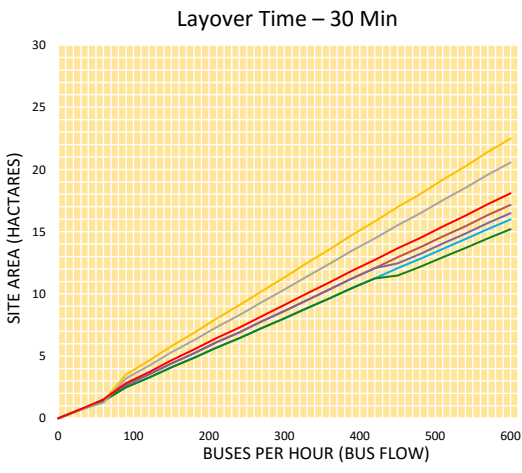
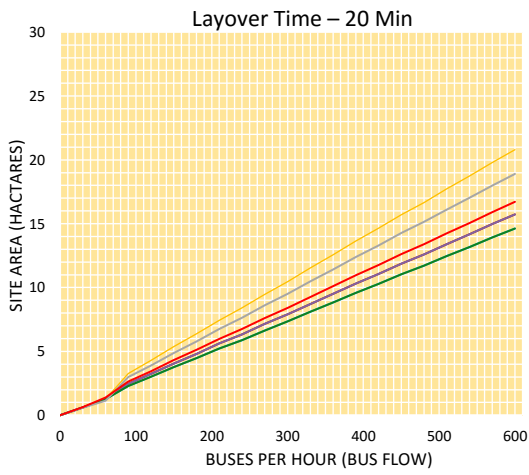
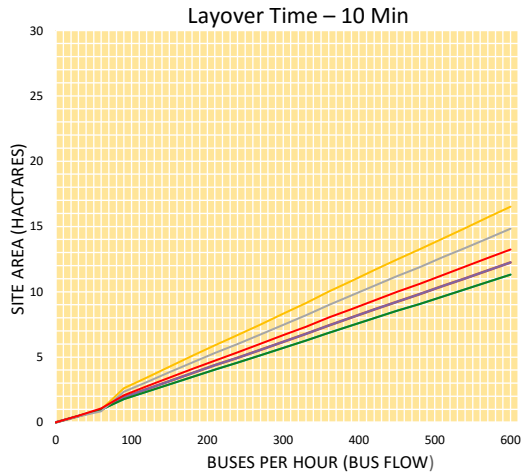

The jump in site requirements at 60 buses per hour is observed for all layover times. This is caused by hike in car parking demand attributed to addition of real-estate / commercial development required to offset terminal development cost. Additional factors contributing to this jump are inclusion of functions such as workshop facility, as per medium bus terminal requirements.

For layover time 10 and 20 minutes, the scenarios 3 and 4 overlap with scenarios 5 and 6. This is because for the layover times idle bus parking demand does not exceed 130, therefore multi level bus parking is not warranted.

The drop observed for scenario 5 and 6 with layover time 30min, 40min, 50min., and 60 min at 420bus/hr., 240bus/hr., 180bus/hr., and 120bus/hr. respectively is due to introduction of multilevel bus parking when idle bus parking demand crosses the minimum threshold of 130.

- | | | | |
|---|---|--|---|
| 1. Without Real Estate Development, at grade Parking (Car & Bus) | — | 5. With Real Estate development, Multilevel (Ramp) Car and Multilevel (Ramp) Bus parking | — |
| 2. With Real Estate Development, at grade Parking (Car & Bus) | — | 6. With Real Estate development, Multilevel (Mechanical) Car and Multilevel (Ramp) Bus parking | — |
| 3. With Real Estate development, Multilevel (Ramp) Car and (At grade) Bus parking | — | 7. With Real Estate Development, Basement Parking Car parking & at grade Bus Parking | — |
| 4. With Real Estate development, Multilevel (Mechanical) Car and (At grade) Bus parking | — | | |

Typology	Inter State	A
Operation	Dynamic Bay	b

Site Area Requirement

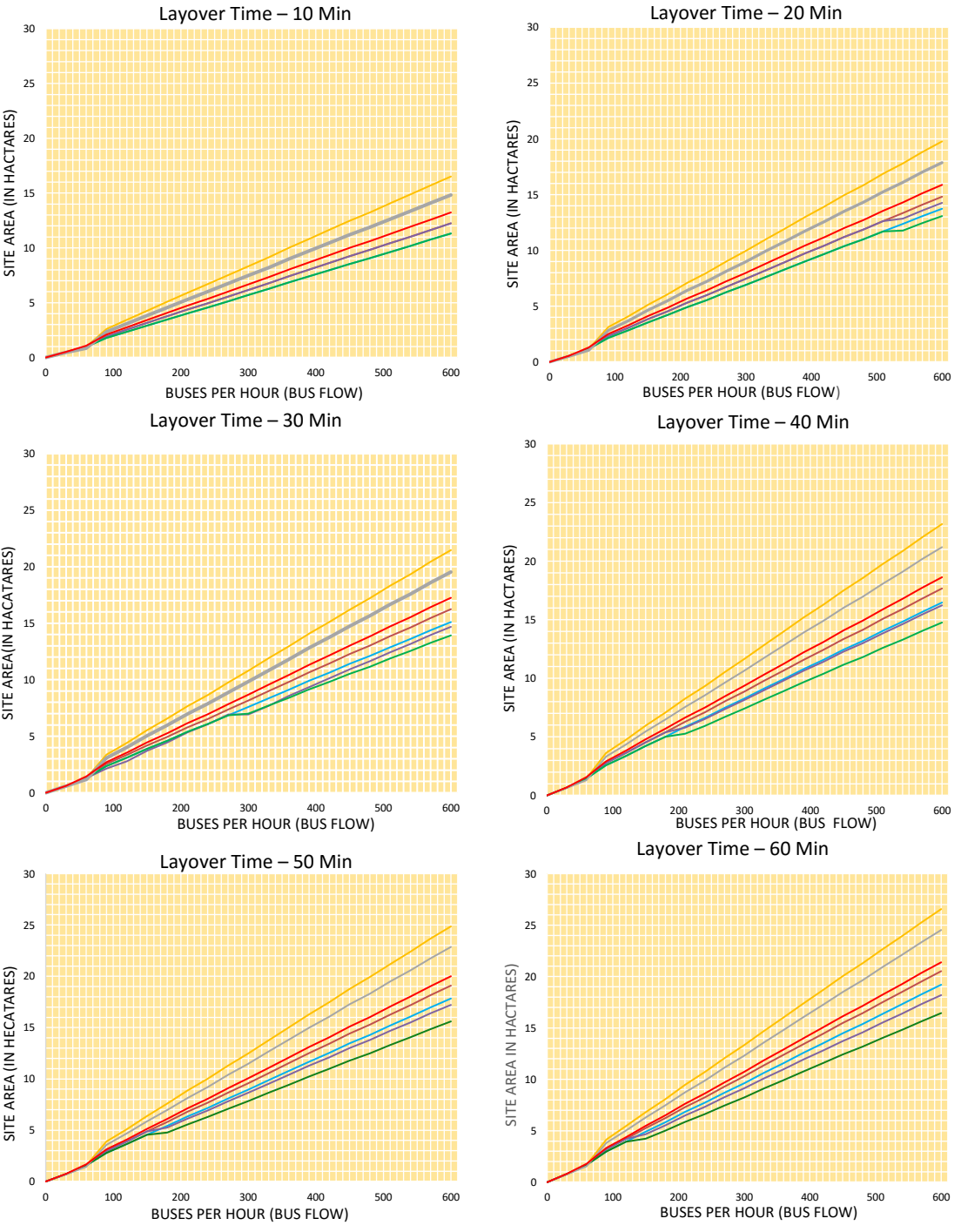

The jump in site requirements at 60 buses per hour is observed for all layover times. This is caused by hike in car parking demand attributed to addition of real-estate / commercial development required to offset terminal development cost. Additional factors contributing to this jump are inclusion of functions such as workshop facility, as per medium bus terminal requirements.

For layover time 10 and 20 minutes, the scenarios 3 and 4 overlap with scenarios 5 and 6. This is because for the layover times idle bus parking demand does not exceed 130, therefore multi level bus parking is not warranted.

The drop observed for scenario 5 and 6 with layover time 20 min, 30min, 40min, 50min, and 60 min at 530 bus/hr, 420bus/hr., 240bus/hr., 180bus/hr., and 120bus/hr. respectively is due to introduction of multilevel bus parking when idle bus parking demand crosses the minimum threshold of 130.

- 1. Without Real Estate Development, at grade Parking (Car & Bus) —
- 2. With Real Estate Development, at grade Parking (Car & Bus) —
- 3. With Real Estate development, Multilevel (Ramp) Car and (At grade) Bus parking —
- 4. With Real Estate development, Multilevel (Mechanical) Car and (At grade) Bus parking —
- 5. With Real Estate development, Multilevel (Ramp) Car and Multilevel (Ramp) Bus parking —
- 6. With Real Estate development, Multilevel (Mechanical) Car and Multilevel (Ramp) Bus parking —
- 7. With Real Estate Development, Basement Parking Car parking & at grade Bus Parking —

Spatial Requirements

Aa

Typology	Inter State	A
Operation	Fixed Route Bay	a

Car parking Requirement

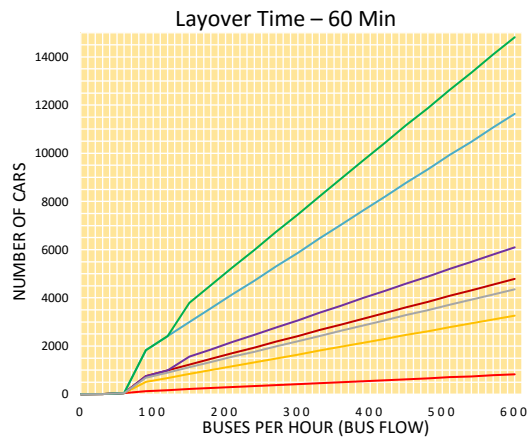
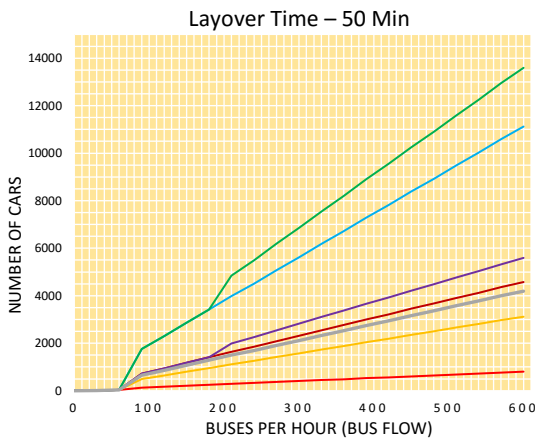
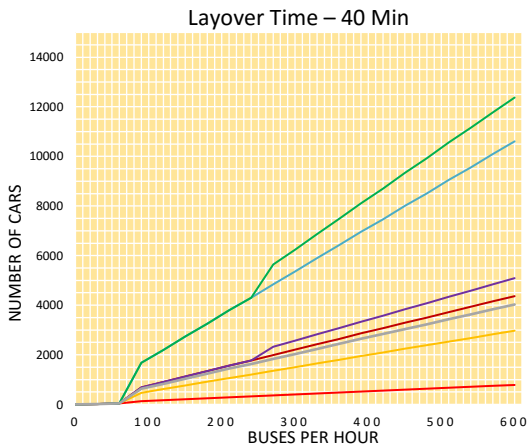
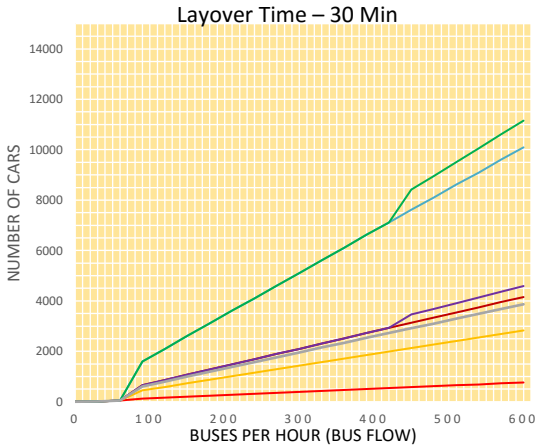
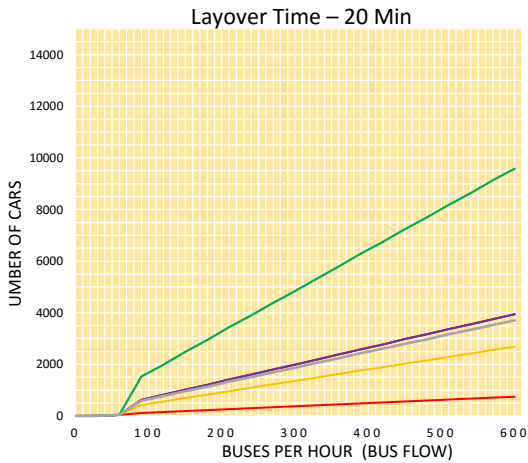
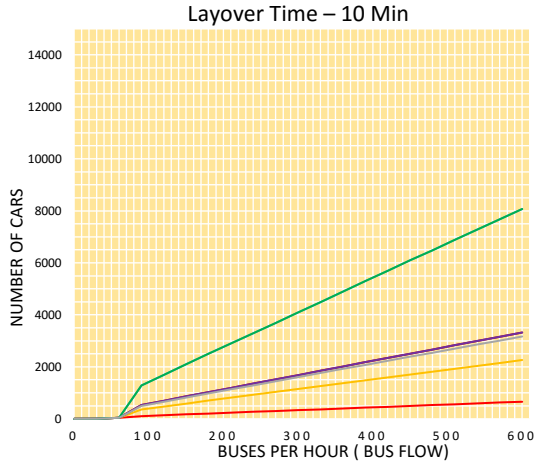

In all layover times (for scenarios 2 to 7), the jump observed in car parking requirement at 90 buses per hour is due to increased real-estate/commercial development to offset terminal development cost.

For scenarios 5 and 6, at layover time 30 min, 40 min, 50 min, and 60 min, the jump at 420 buses per hour, 240 buses per hour, 180 buses per hour and 120 buses per hour respectively refers to the jump in car parking requirement attributed to increased real-estate/commercial development to offset additional cost of development of multilevel bus parking. Multilevel bus parking becomes feasible when when idle bus parking demand exceeds 130.

- | | | | |
|---|--|--|--|
| 1. Without Real Estate Development, at grade Parking (Car & Bus) | | 5. With Real Estate development, Multilevel (Ramp) Car and | |
| 2. With Real Estate Development, at grade Parking (Car & Bus) | | Multilevel (Ramp) Bus parking | |
| 3. With Real Estate development, Multilevel (Ramp) Car and (At grade) Bus parking | | 6. With Real Estate development, Multilevel (Mechanical) Car | |
| 4. With Real Estate development, Multilevel (Mechanical) Car and (At grade) Bus parking | | and Multilevel (Ramp) Bus parking | |
| | | 7. With Real Estate Development, Basement Parking Car | |
| | | parking & at grade Bus Parking | |

Typology	Inter State	A
Operation	Dynamic Bay	b

Car parking Requirement

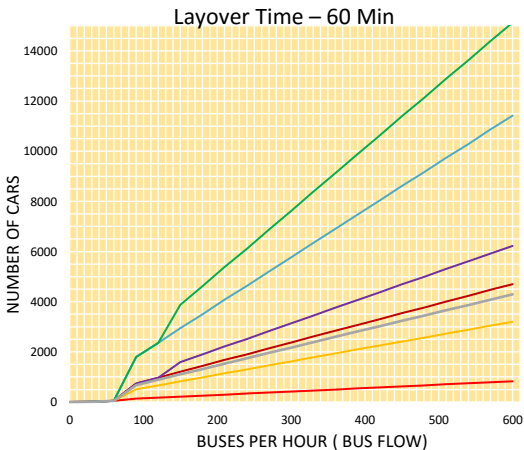
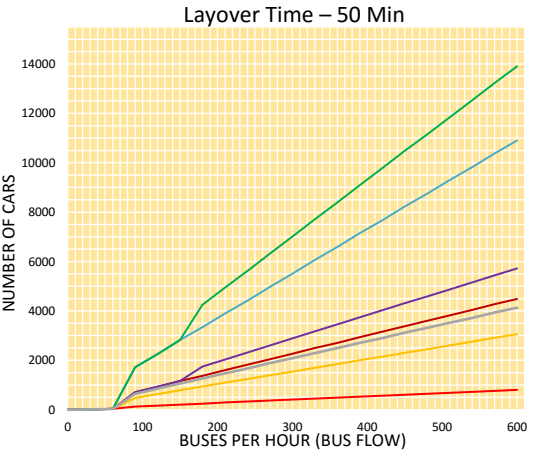
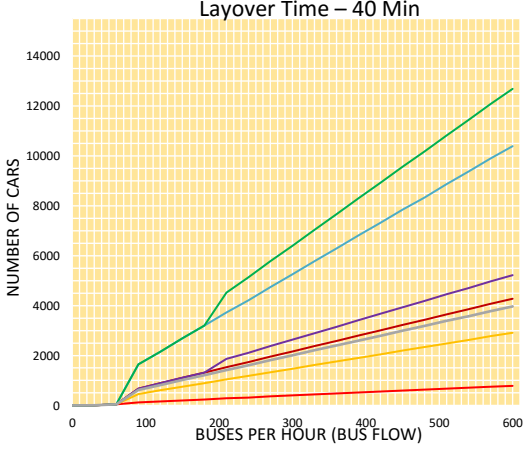
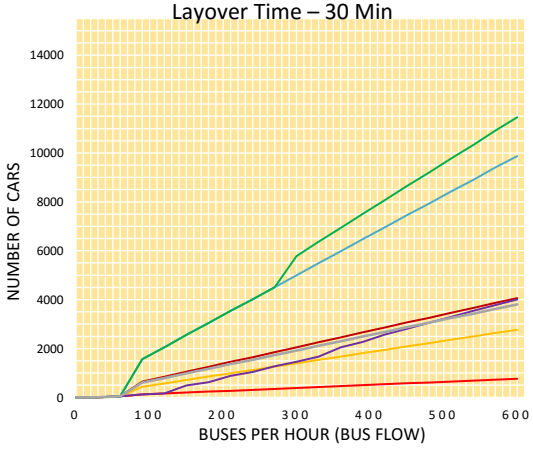
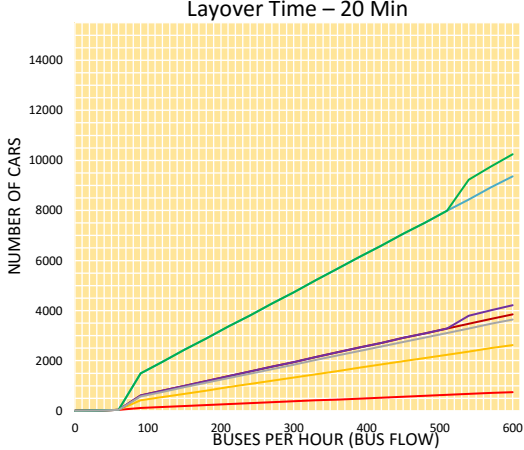
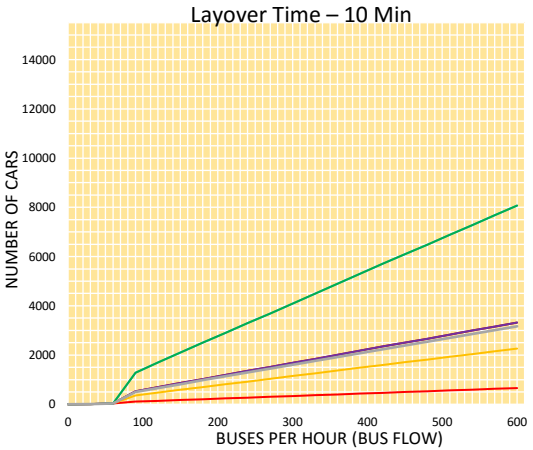

In all layover times (for scenarios 2 to 7), the jump observed in car parking requirement at 60 buses per hour is due to increased real-estate/commercial development to offset terminal development cost.

For scenarios 5 and 6, at layover time 20 min, 30 min, 40 min, 50 min, and 60 min, the jump at 530 buses per hour, 420 buses per hour, 240 buses per hour and 120 buses per hour respectively refers to the jump in car parking requirement attributed to increased real-estate/commercial development to offset additional cost of development of multilevel bus parking. Multilevel bus parking becomes feasible when idle bus parking demand exceeds 130.

- | | | | |
|---|--|--|--|
| 1. Without Real Estate Development, at grade Parking (Car & Bus) | | 5. With Real Estate development, Multilevel (Ramp) Car and Multilevel (Ramp) Bus parking | |
| 2. With Real Estate Development, at grade Parking (Car & Bus) | | 6. With Real Estate development, Multilevel (Mechanical) Car and Multilevel (Ramp) Bus parking | |
| 3. With Real Estate development, Multilevel (Ramp) Car and (At grade) Bus parking | | 7. With Real Estate Development, Basement Parking Car parking & at grade Bus Parking | |
| 4. With Real Estate development, Multilevel (Mechanical) Car and (At grade) Bus parking | | | |

Spatial Requirements

Aa

Typology	Inter State	A
Operation	Fixed Route Bay	a

Bus Bay Numbers

Boarding Bay Numbers

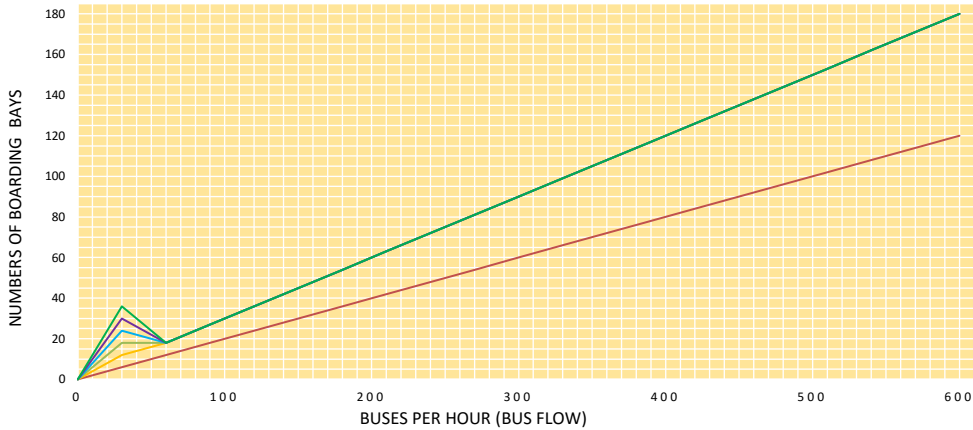

Off-loading Bay Numbers

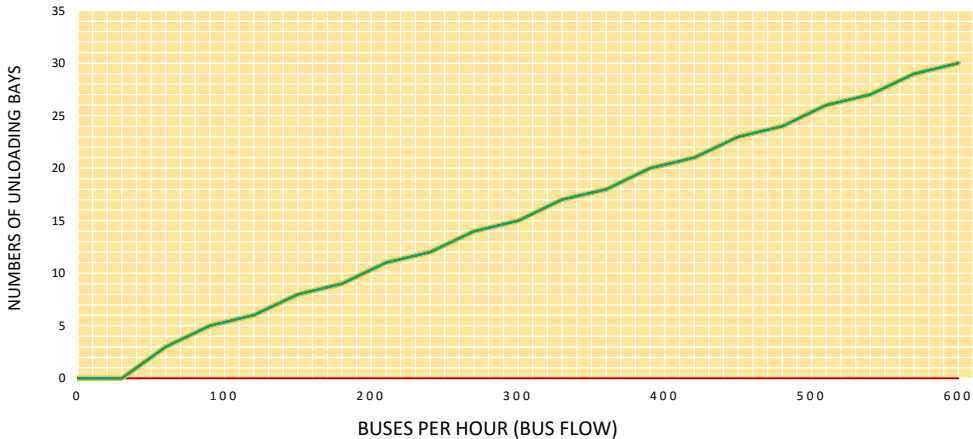

Idle Bay Numbers

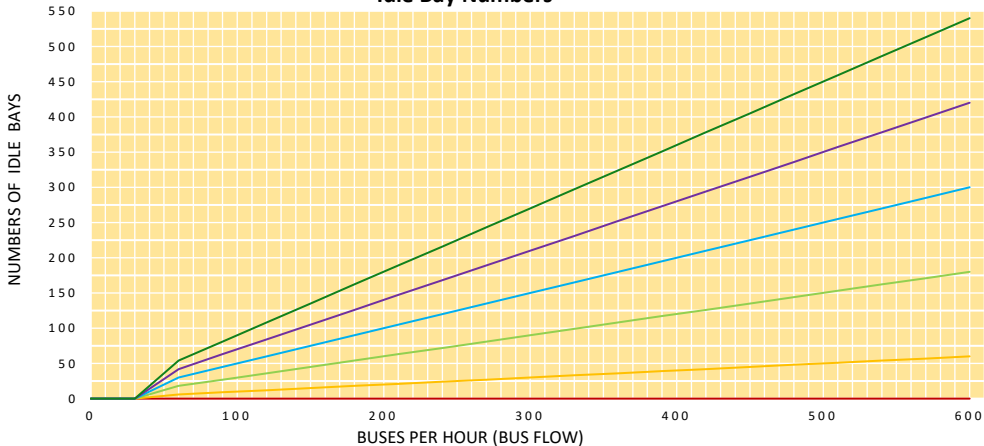

For layover time less than 10 min, it is not feasible to segregate the boarding, alighting and idle parking functions. For Layover time more than 10 min and bus flow more than 30 bus/hr, idle parking and offloading bays are introduced leading to a drop in boarding bay requirement.

- | | | | | | |
|---------------------|--|---------------------|---------------------------------------|---------------------|---|
| Layover time 10 min | — | Layover time 20 min | — | Layover time 30 min | — |
| Layover time 40 min | — | Layover time 50 min | — | Layover time 60 min | — |

Spatial Requirements

Ab

Typology	Inter State	A
Operation	Dynamic Bay	b

Bus Bay Numbers

Boarding Bay Numbers

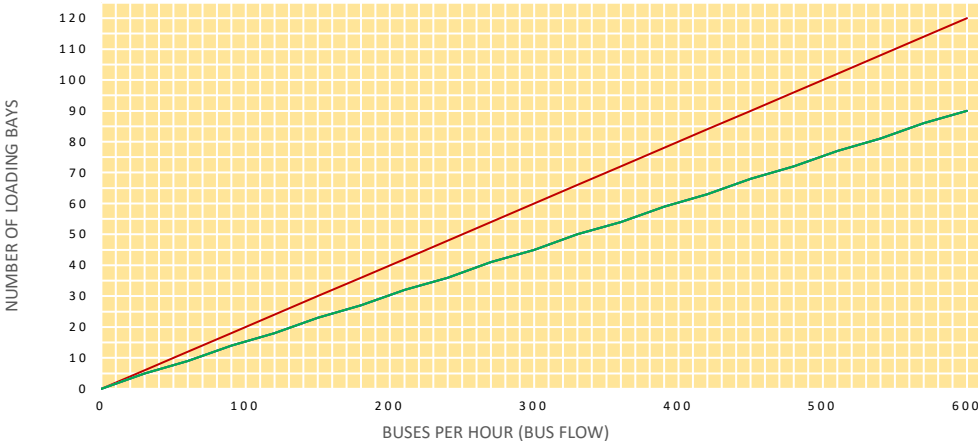

Off-loading Bay Numbers

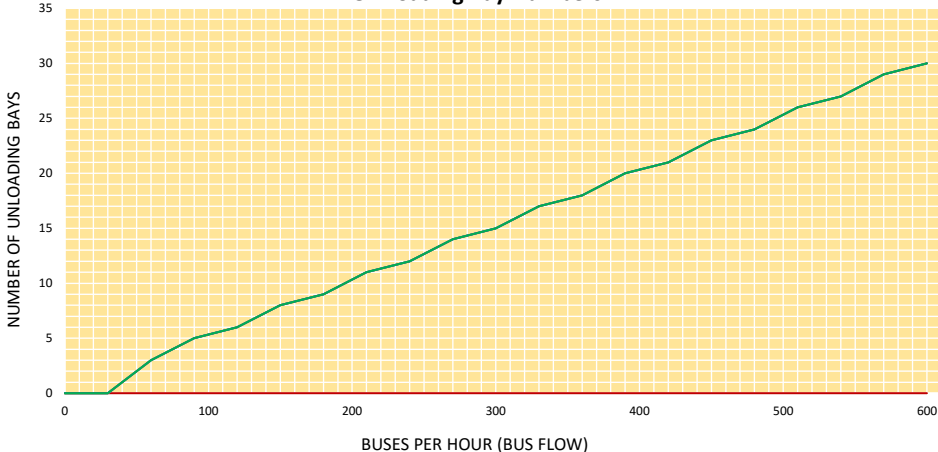

Idle Bay Numbers

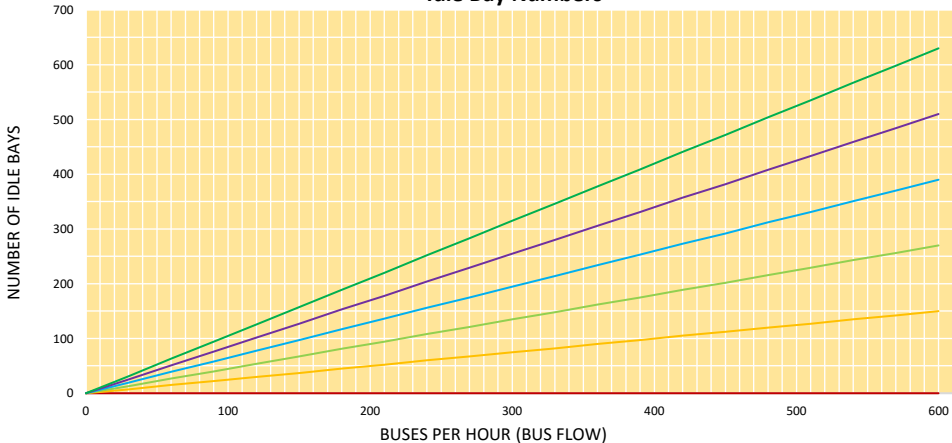

- Layover time 10 min
- Layover time 20 min
- Layover time 30 min
- Layover time 40 min
- Layover time 50 min
- Layover time 60 min

Spatial Requirements

Aa

Typology	Inter State	A
Operation	Fixed route Bay	a

Passenger Accumulation and Passenger Flow

Passenger Accumulation

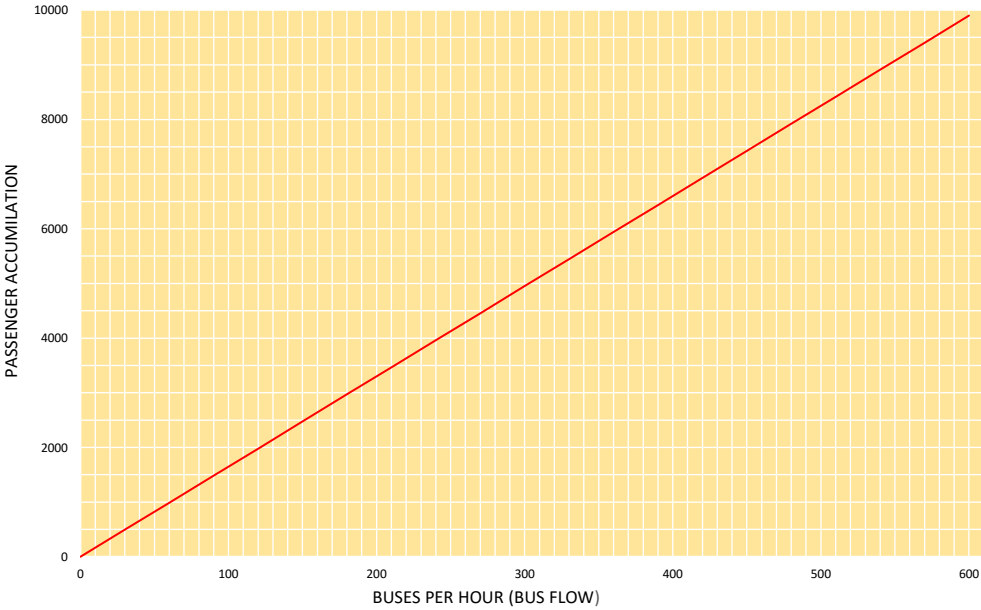

Passenger Flow

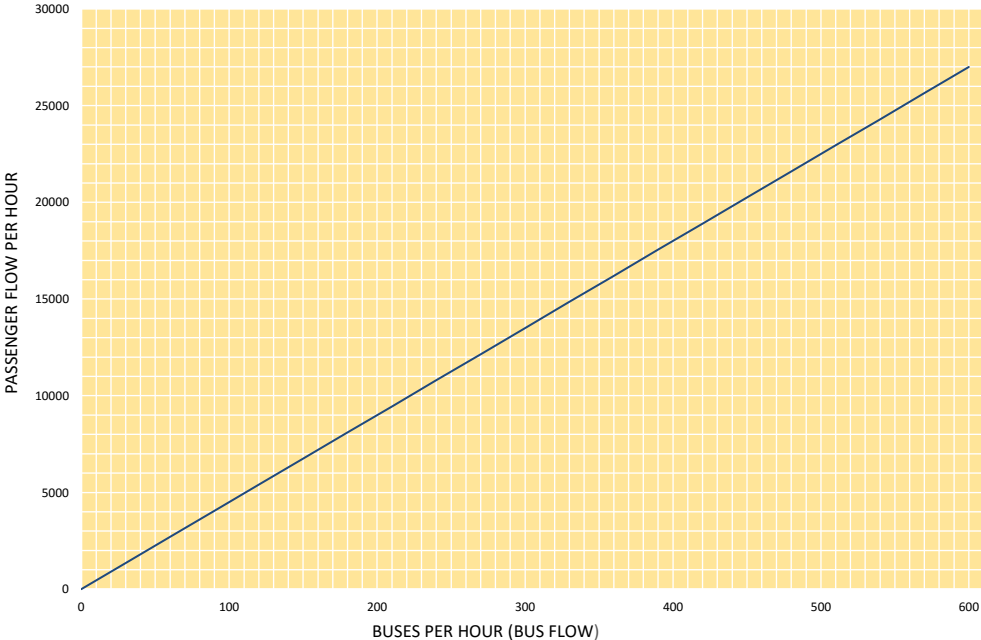

For all terminal sizes, With increasing bus flow per hour the passenger flow and passenger accumulation grows with a constant rate.

- Passenger Accumulation —
- Passenger flow per hour —

Spatial Requirements

Aa

Typology	Inter State	A
Operation	Dynamic Bay	a

Passenger Accumulation and Passenger Flow

Passenger Accumulation

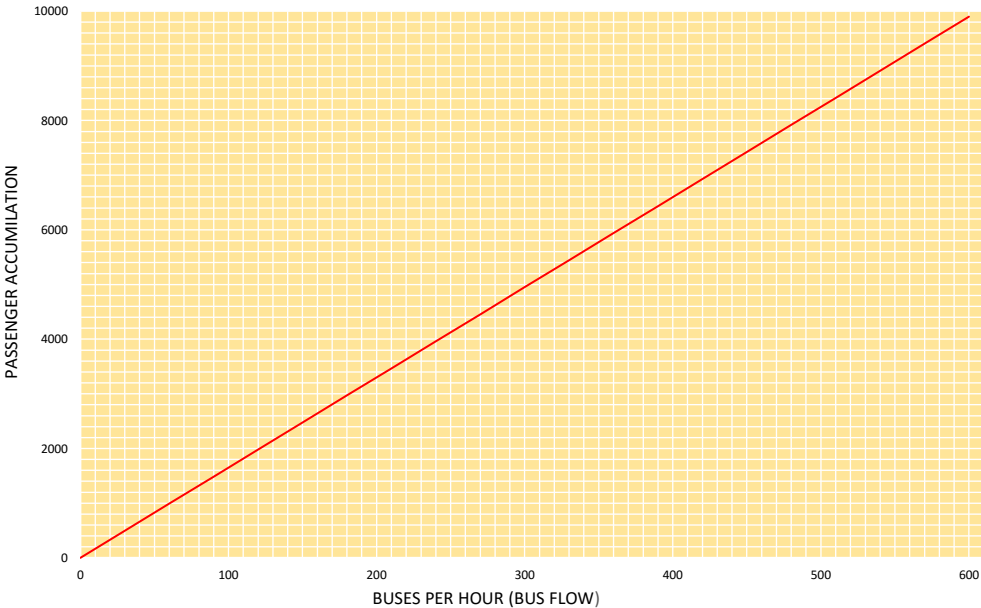

Passenger Flow

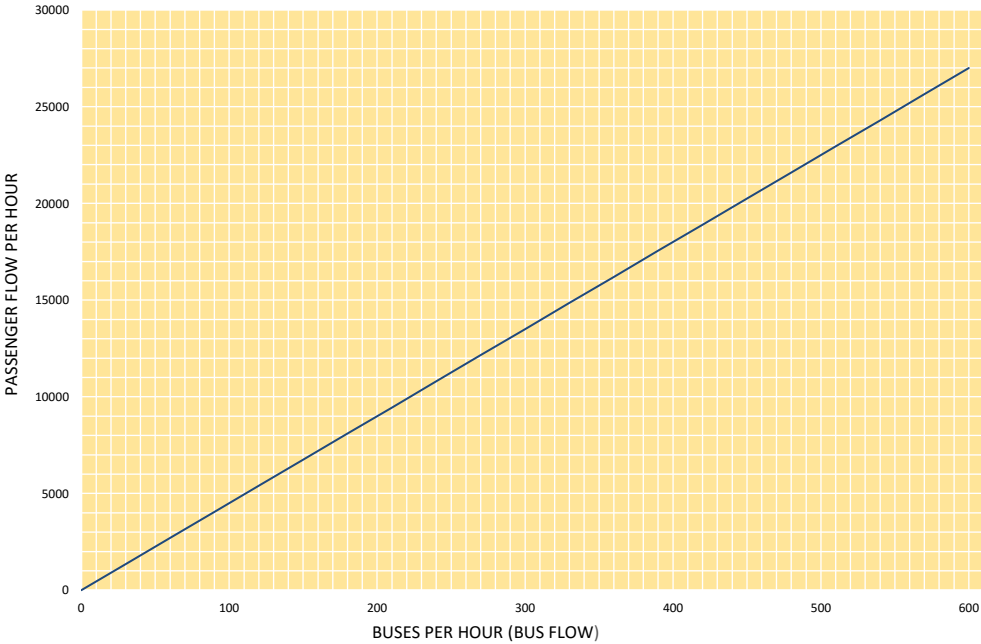

For all terminal sizes, With increasing bus flow per hour the passenger flow and passenger accumulation grows with a constant rate.

- Passenger Accumulation —
- Passenger flow per hour —

Spatial Requirements

Aa

Typology	Inter State	A
Operation	Fixed Route Bay	a

Floor Area Ratio (FAR)

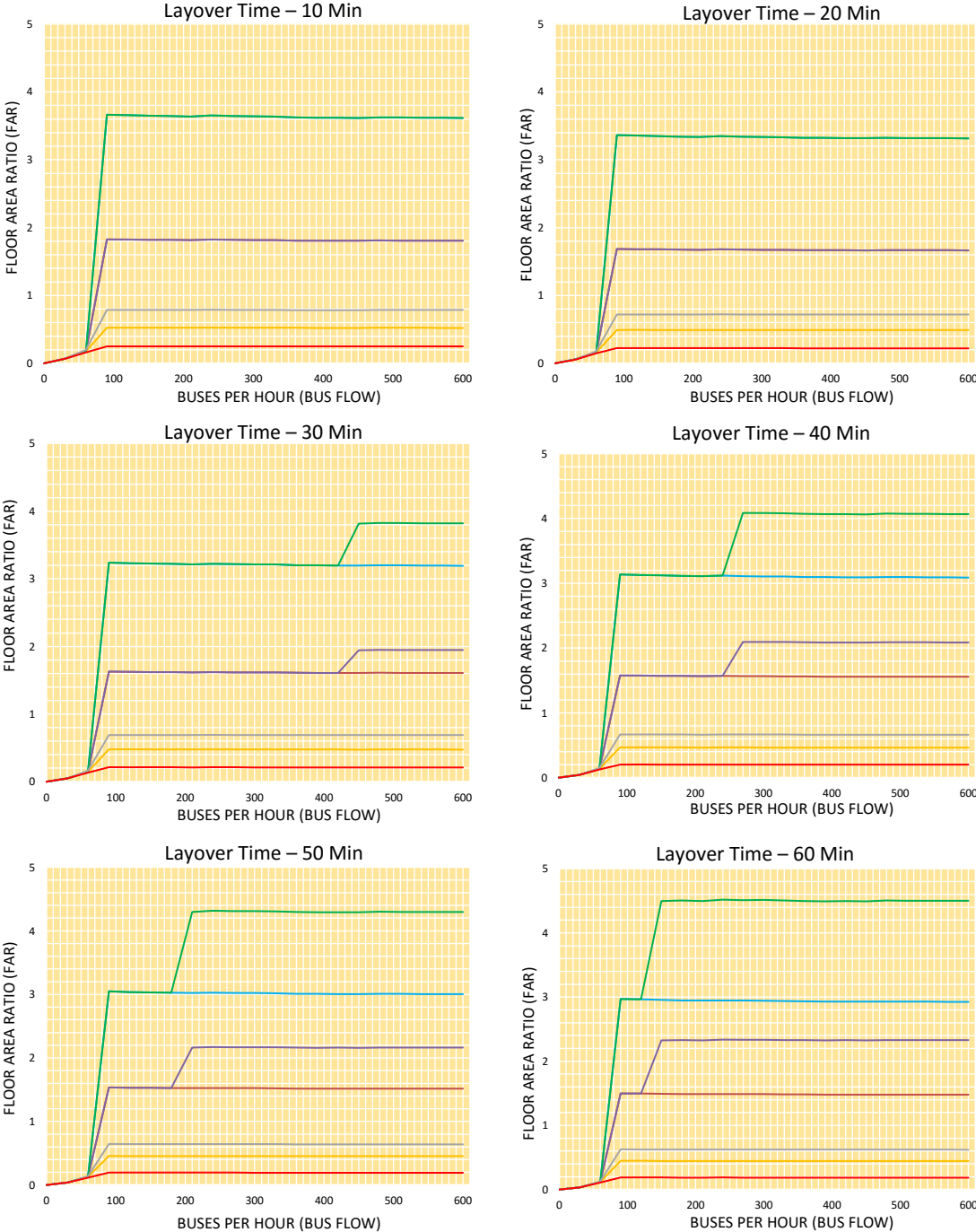

In scenarios 2 to 7, the jump in FAR requirement at 60 buses per hour is attributed to introduction of real estate development in order to offset the cost of terminal development. The jump is larger for scenarios 3 to 6, on account of higher built up required for structured parking.

For scenarios 5 and 6, the jump in FAR requirement at layover time 30 min, 40 min, 50 min, and 60 min, the jump at 420 buses per hour, 240 buses per hour, 180 buses per hour and 120 buses per hour respectively refers to the introduction of structured bus parking when idle bus parking requirement exceeds 130.

- | | | | |
|--|---|--|---|
| 1. Without Real Estate Development, at grade Parking (Car & Bus) | — | 5. With Real Estate development, Multilevel (Ramp) Car and | — |
| 2. With Real Estate Development, at grade Parking (Car & Bus) | — | Multilevel (Ramp) Bus parking | — |
| 3. With Real Estate development, Multilevel (Ramp) Car and (At | — | 6. With Real Estate development, Multilevel (Mechanical) Car | — |
| grade) Bus parking | — | and Multilevel (Ramp) Bus parking | — |
| 4. With Real Estate development, Multilevel (Mechanical) Car and (At | — | 7. With Real Estate Development, Basement Parking Car | — |
| grade) Bus parking | — | parking & at grade Bus Parking | — |

Typology	Inter State	A
Operation	Dynamic Bay	b

Floor Area Ratio (FAR)

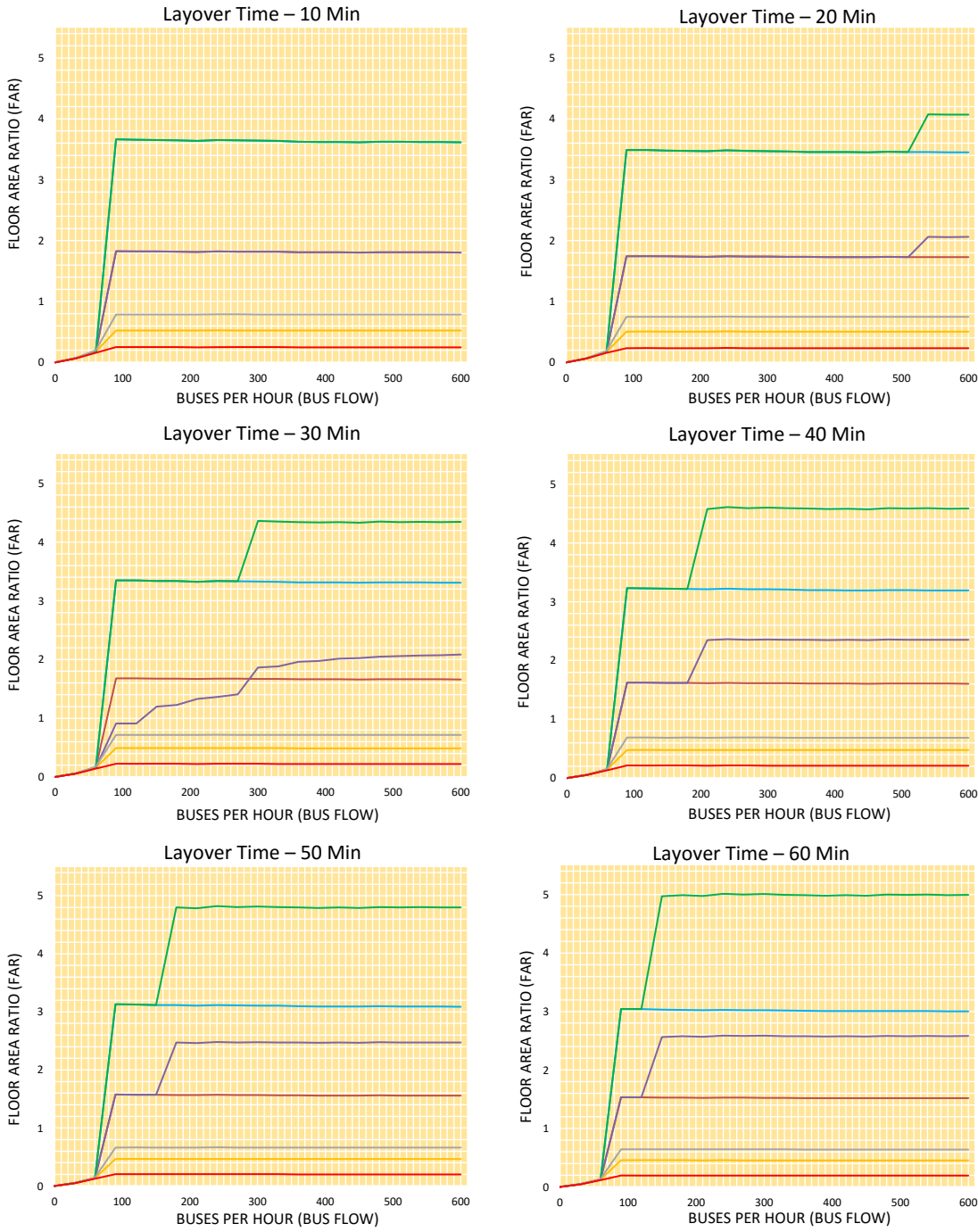

In scenarios 2 to 7, the jump in FAR requirement at 60 buses per hour is attributed to introduction of real estate development in order to offset the cost of terminal development. The jump is larger for scenarios 3 to 6, on account of higher built up required for structured parking.

For scenarios 5 and 6, the jump in FAR requirement at layover time 20 min, 30 min, 40 min, 50 min, and 60 min, the jump at 530 buses per hour, 420 buses per hour, 240 buses per hour and 120 buses per hour respectively refers to the introduction of structured bus parking when idle bus parking requirement exceeds 130.

- | | | | |
|---|--|--|--|
| 1. Without Real Estate Development, at grade Parking (Car & Bus) | | 5. With Real Estate development, Multilevel (Ramp) Car and Multilevel (Ramp) Bus parking | |
| 2. With Real Estate Development, at grade Parking (Car & Bus) | | 6. With Real Estate development, Multilevel (Mechanical) Car and Multilevel (Ramp) Bus parking | |
| 3. With Real Estate development, Multilevel (Ramp) Car and (At grade) Bus parking | | 7. With Real Estate Development, Basement Parking Car parking & at grade Bus Parking | |
| 4. With Real Estate development, Multilevel (Mechanical) Car and (At grade) Bus parking | | | |

Spatial Requirements

Aa

Typology	Inter State	A
Operation	Fixed Route Bay	a

Total Built up Area

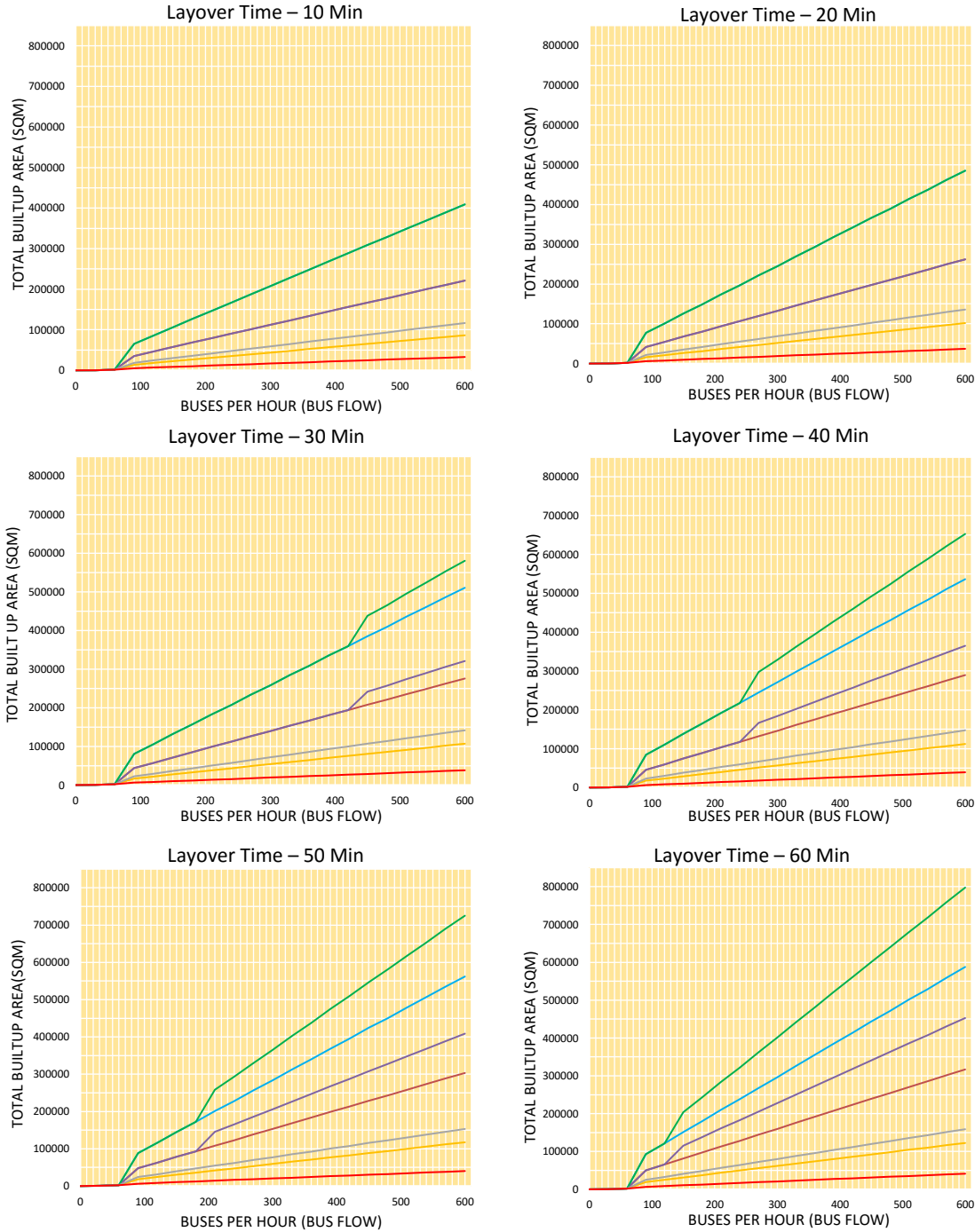

In scenarios 2 to 7, the jump in total built up area at 60 buses per hour is attributed to introduction of real estate development in order to offset the cost of terminal development. The jump is larger for scenarios 3 to 6, on account of higher built up required for structured parking.

For scenarios 5 and 6, the jump in total built up at layover time 30 min, 40 min, 50 min, and 60 min, the jump at 420 buses per hour, 240 buses per hour, 180 buses per hour and 120 buses per hour respectively refers to the introduction of structured bus parking when idle bus parking requirement exceeds 130.

- | | | | |
|---|---------------------------------------|--|--|
| 1. Without Real Estate Development, at grade Parking (Car & Bus) | — | 5. With Real Estate development, Multilevel (Ramp) Car and | — |
| 2. With Real Estate Development, at grade Parking (Car & Bus) | — | Multilevel (Ramp) Bus parking | |
| 3. With Real Estate development, Multilevel (Ramp) Car and (At grade) Bus parking | — | 6. With Real Estate development, Multilevel (Mechanical) Car | — |
| 4. With Real Estate development, Multilevel (Mechanical) Car and (At grade) Bus parking | — | and Multilevel (Ramp) Bus parking | |
| | | 7. With Real Estate Development, Basement Parking Car | — |
| | | parking & at grade Bus Parking | — |

Typology	Inter State	A
Operation	Dynamic Bay	b

Total Built Up Area

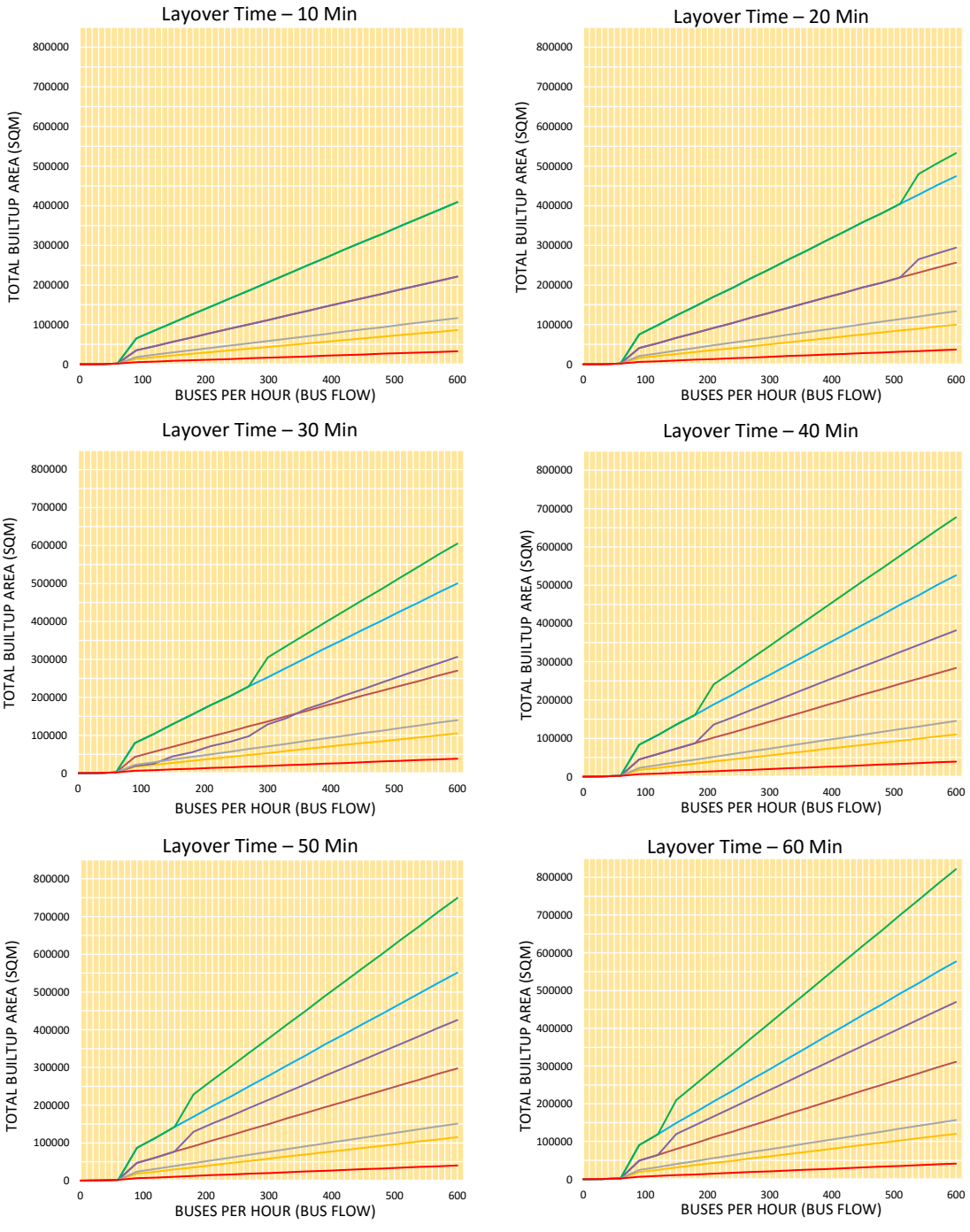

In scenarios 2 to 7, the jump in total built up area at 60 buses per hour is attributed to introduction of real estate development in order to offset the cost of terminal development. The jump is larger for scenarios 3 to 6, on account of higher built up required for structured parking.

For scenarios 5 and 6, the jump in total built up at layover time 20 min, 30 min, 40 min, 50 min, and 60 min, the jump at 530 buses per hour, 420 buses per hour, 180 buses per hour and 120 buses per hour respectively refers to the introduction of structured bus parking when idle bus parking requirement exceeds 130.

- 1. Without Real Estate Development, at grade Parking (Car & Bus) —
- 2. With Real Estate Development, at grade Parking (Car & Bus) —
- 3. With Real Estate development, Multilevel (Ramp) Car and (At grade) Bus parking —
- 4. With Real Estate development, Multilevel (Mechanical) Car and (At grade) Bus parking —
- 5. With Real Estate development, Multilevel (Ramp) Car and Multilevel (Ramp) Bus parking —
- 6. With Real Estate development, Multilevel (Mechanical) Car and Multilevel (Ramp) Bus parking —
- 7. With Real Estate Development, Basement Parking Car parking & at grade Bus Parking —

Spatial Requirements

Aa

Typology	Inter State	A
Operation	Fixed Route Bay	a

Parking Built up Area

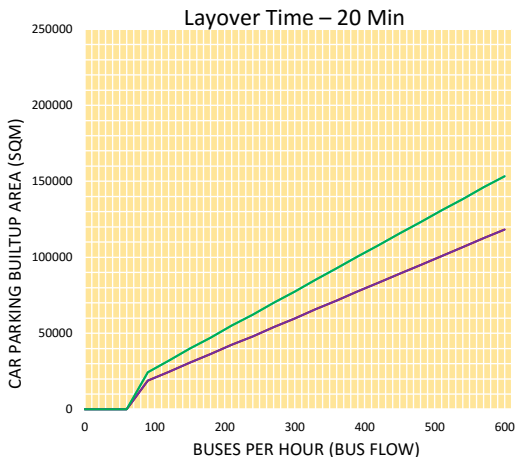
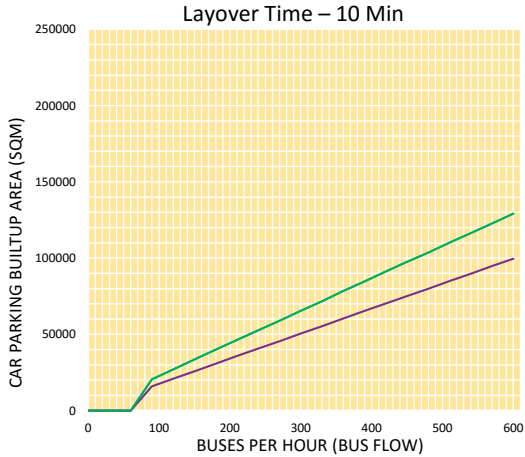

For parking built up area, out of all 7 scenarios only the 4 scenarios which accounts for multilevel car parking and bus parking are considered .i.e.Scenario 3,4, 5 and 6 respectively

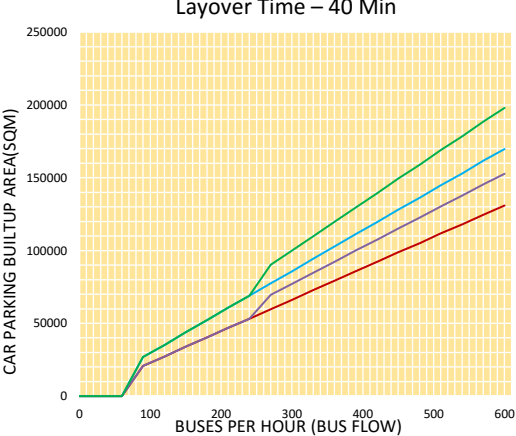
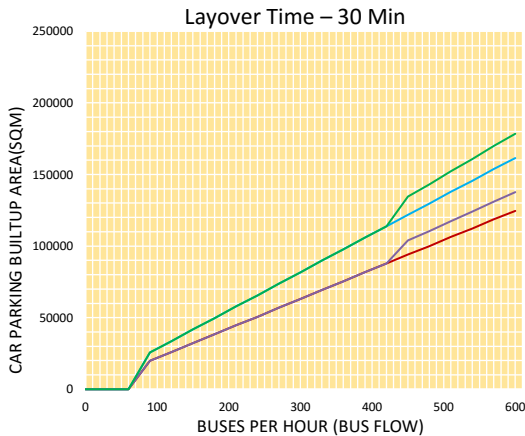

In scenarios 3 and 4, the jump in parking built up area at 90 buses per hour is attributed to introduction of structured parking when total car parking demand exceeds 120. This caused by added parking demand for real estate development, introduced to offset the cost of terminal development.

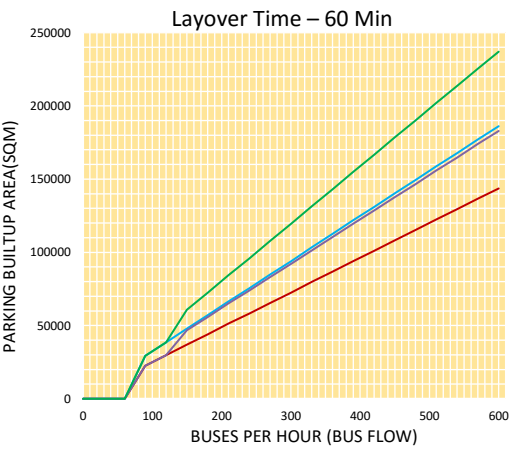
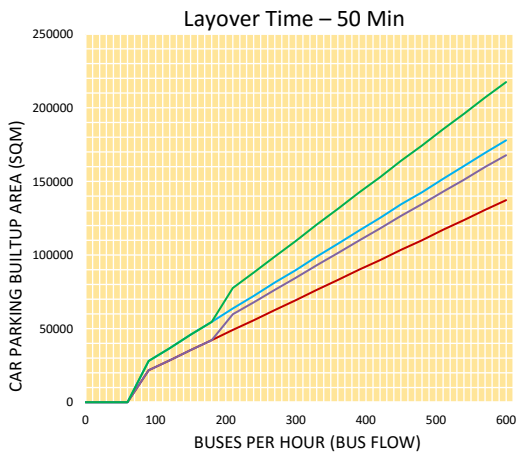

For scenarios 5 and 6, the jump in parking built up at layover time 30 min, 40 min, 50 min, and 60 min, the jump at 420 buses per hour, 240 buses per hour, 180 buses per hour and 120 buses per hour respectively refers to increased parking demand attributed to increase in commercial space development. This increase in commercial space development, in turn, is attributed to increase in terminal development cost, because of introduction of structured bus parking when idle bus parking requirement exceeds 130.

- 3. With Real Estate development, Multilevel (Ramp) Car and (At grade) Bus parking.
- 4. With Real Estate development, Multilevel (Mechanical) Car and (At grade) Bus parking.

- 5. With Real Estate development, Multilevel (Ramp) Car and Multilevel (Ramp) Bus parking
- 6. With Real Estate development, Multilevel (Mechanical) Car and Multilevel (Ramp) Bus parking

Typology	Inter State	A
Operation	Dynamic Bay	b

Parking Built Up Area

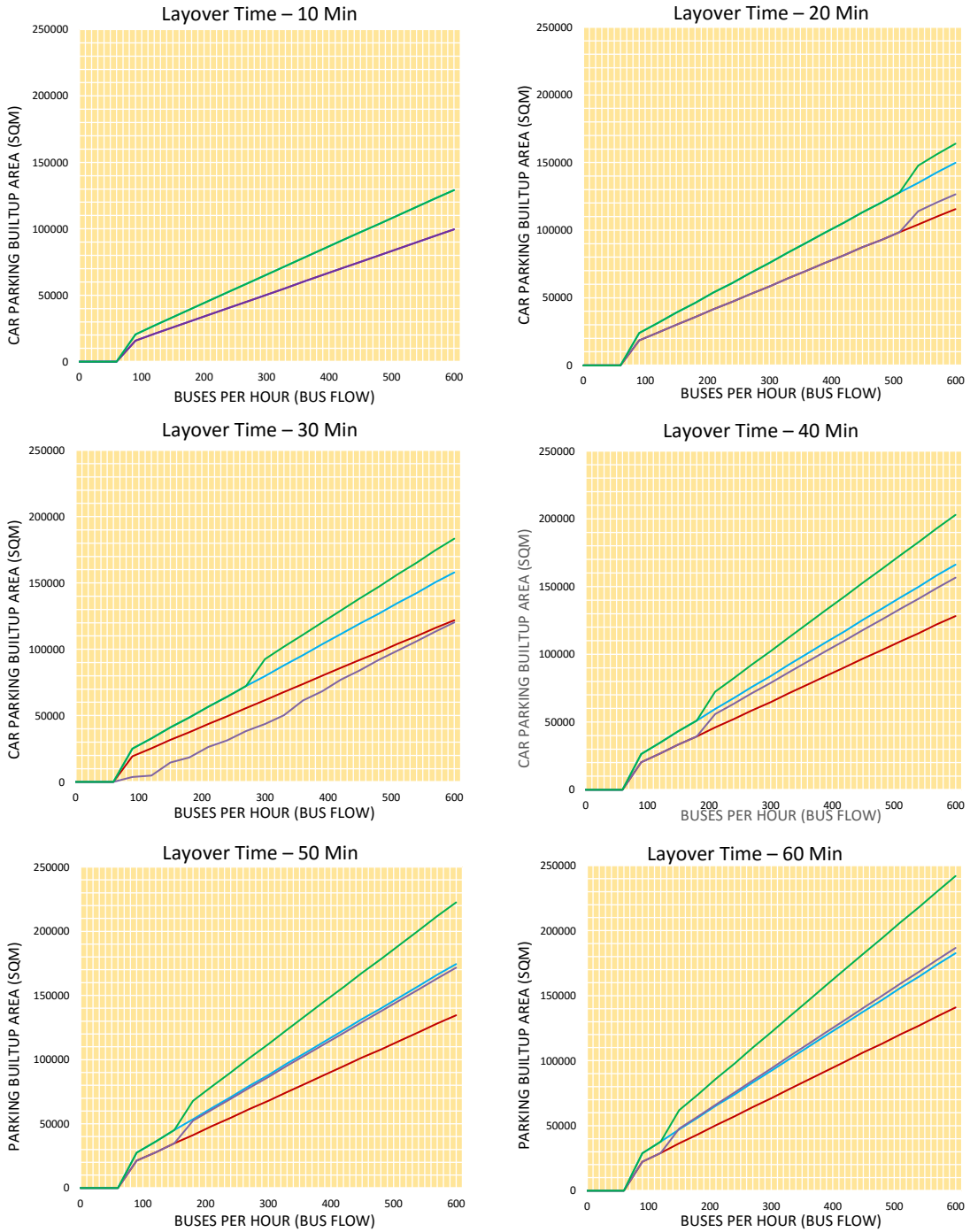

For parking built up area, out of all 7 scenarios only the 4 scenarios which accounts for multilevel car parking and bus parking are considered .i.e.Scenario 3,4, 5 and 6 respectively

In scenarios 3 and 4, the jump in parking built up area at 60 buses per hour is attributed to introduction of structured parking when total car parking demand exceeds 120. This caused by added parking demand for real estate development, introduced to offset the cost of terminal development.

For scenarios 5 and 6, the jump in parking built up at layover time 20 min,30 min, 40 min, 50 min, and 60 min, the jump at 530 buses per hour ,420 buses per hour ,180 buses per hour and 120 buses per hour respectively refers to increased parking demand attributed to increase in commercial space development. This increase in commercial space development, in turn, is attributed to increase in terminal development cost, because of introduction of structured bus parking when idle bus parking requirement exceeds 130.

- 3. With Real Estate development, Multilevel (Ramp) Car and (At grade) Bus parking.
- 4. With Real Estate development, Multilevel (Mechanical) Car and (At grade) Bus parking.

- 5. With Real Estate development, Multilevel (Ramp) Car and Multilevel (Ramp) Bus parking
- 6. With Real Estate development, Multilevel (Mechanical) Car and Multilevel (Ramp) Bus parking

Spatial Requirements

Scenario - 1 : Without Real estate Development (No commercial) and at grade car & Bus Parking.

Aa

Typology	Inter State	A
Operation	Fixed Route Bay	a

Site Area Distribution

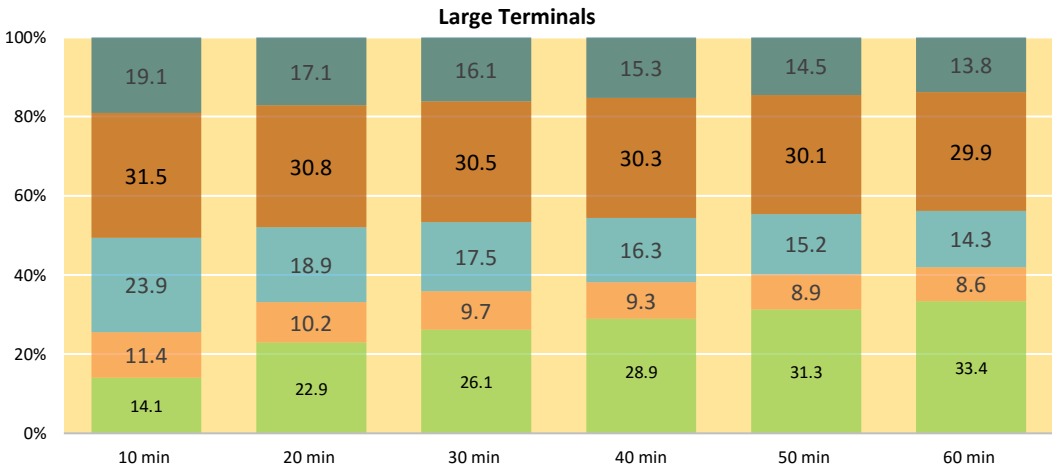
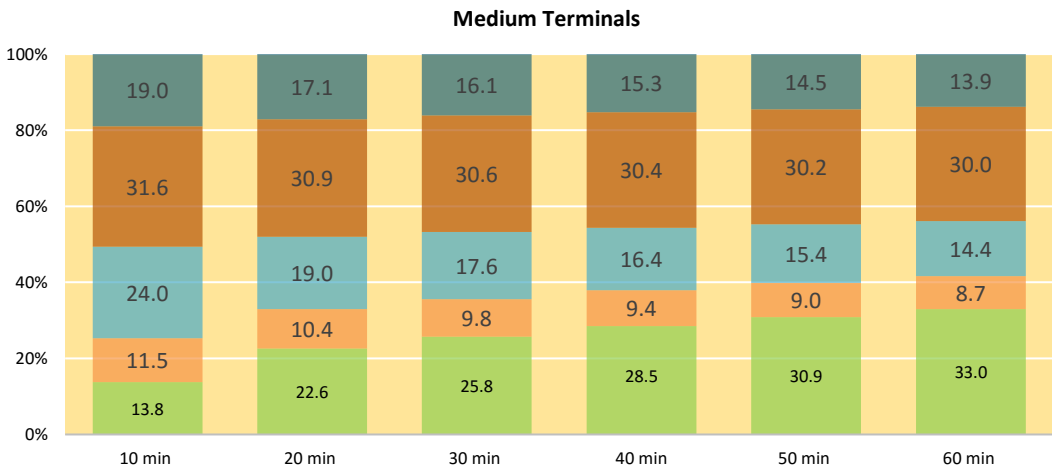
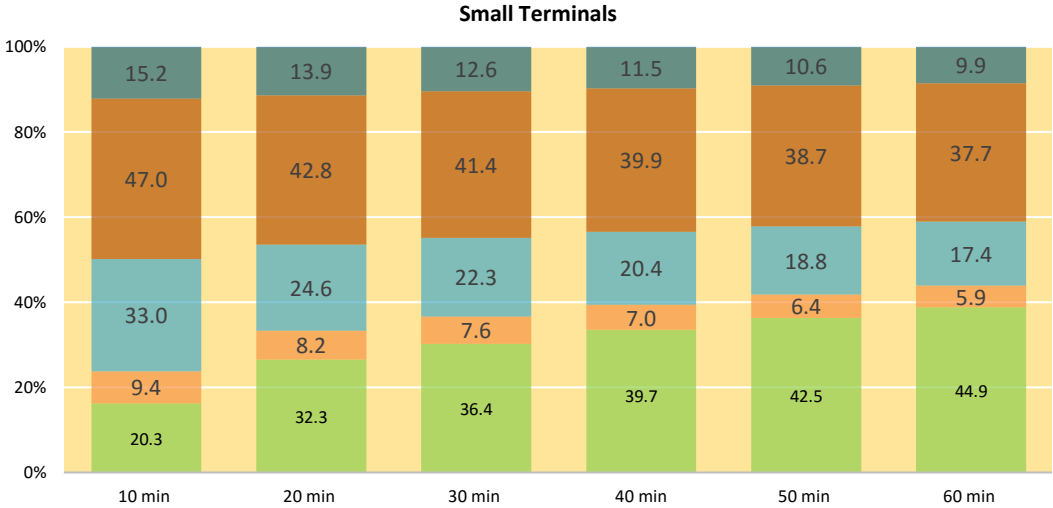

For all terminal sizes, increasing livery time, leads to increasing bus accumulation which leads to increased bus parking area requirement. This results in reduction of percentage of site area under other different functions.

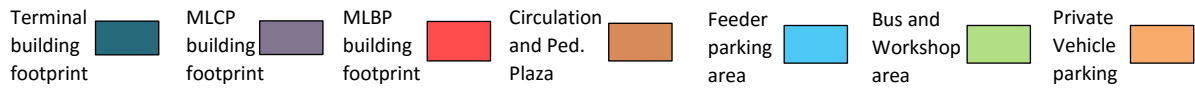

* The values represented here correspond 60 buses per hour for small terminal, 150 buses per hour for medium terminal and 390 buses per hour for large terminals.

Scenario - 1 : Without Real estate Development (No commercial) and at grade car & Bus Parking.

Typology	Inter State	A
Operation	Fixed Route Bay	a

Open Area Distribution

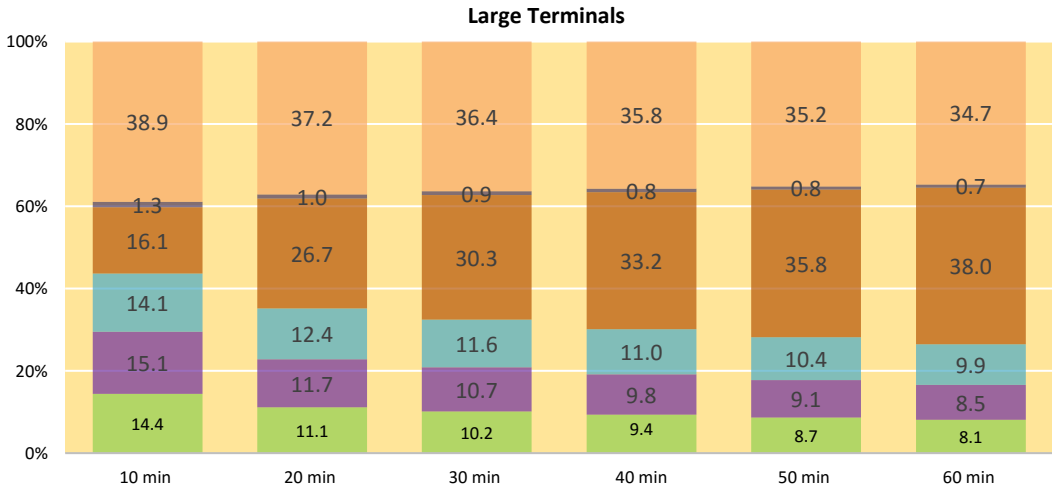
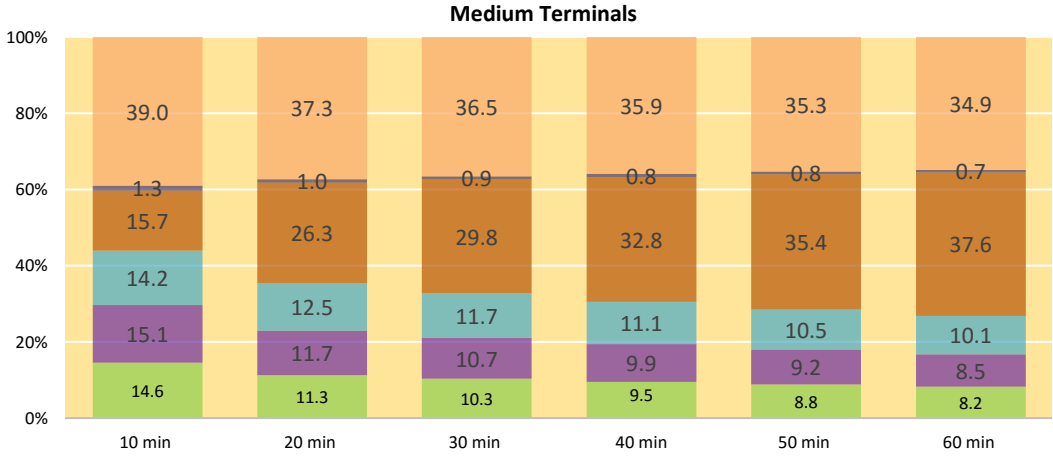
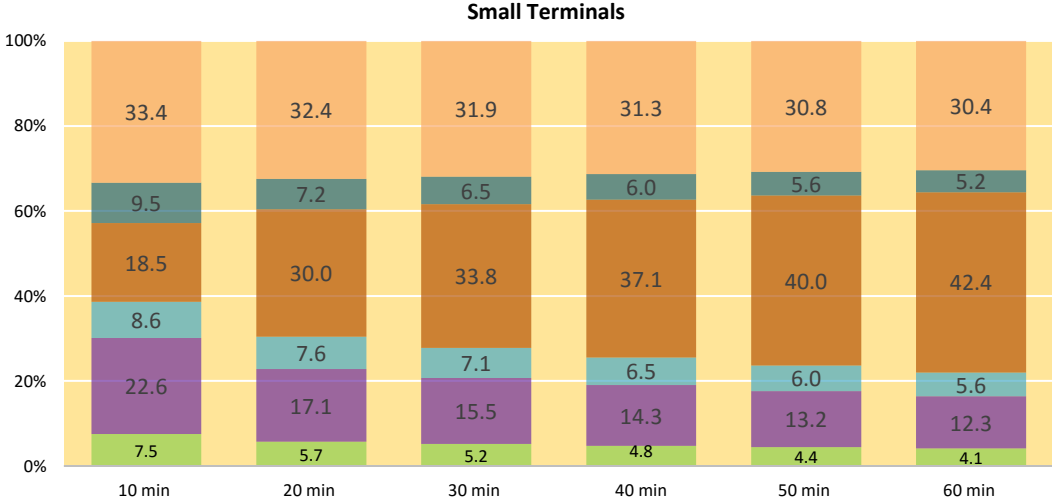

For all terminal sizes, increasing layover time, leads to increasing bus accumulation which leads to increased bus parking area requirement. This results in reduction of percentage of open area under other different functions.

Drop Off █ Pick up █ Car Parking █ Bus Parking █ Circulation area █ Workshop area █ Pedestrian plaza █

* The values represented here correspond 60 buses per hour for small terminal, 150 buses per hour for medium terminal and 390 buses per hour for large terminals.

Spatial Requirements

Scenario -2 : With Real estate Development and at-grade Parking (Car & Bus)

Aa

Typology	Inter State	A
Operation	Fixed Route Bay	a

Site Area Distribution

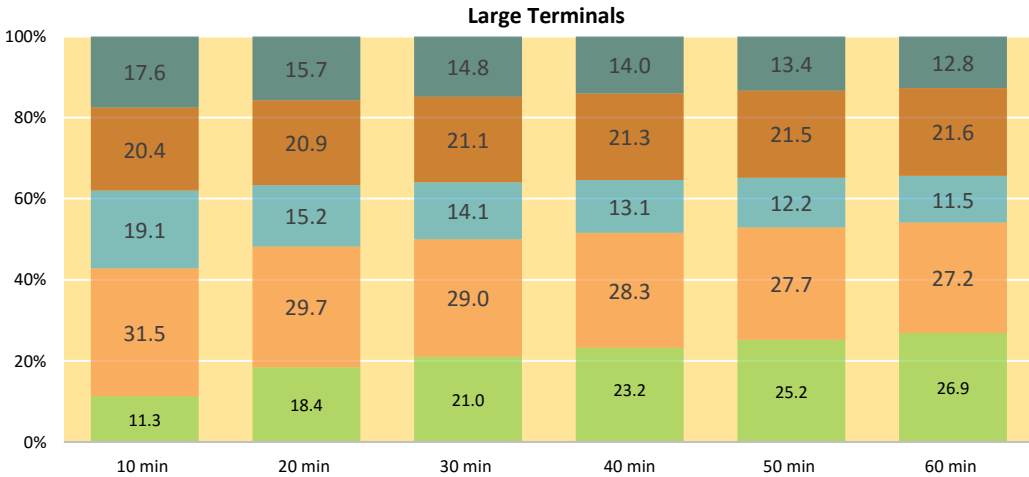
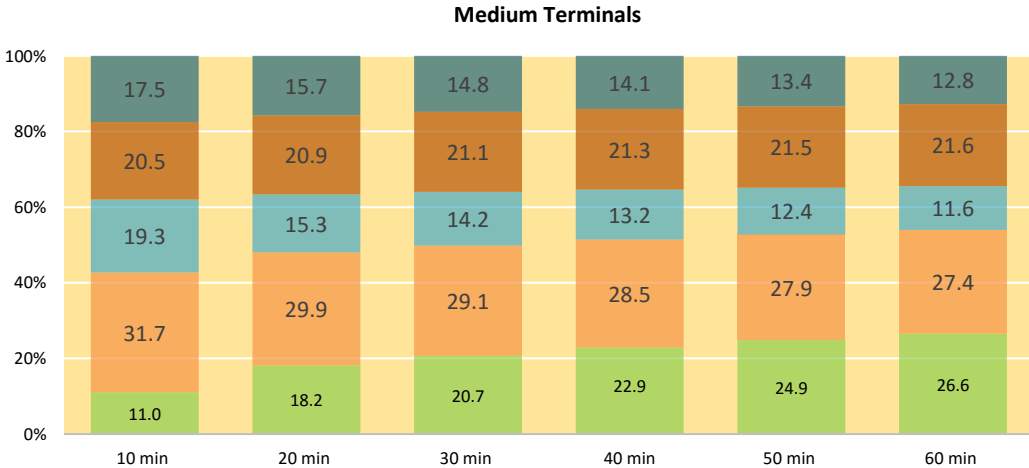
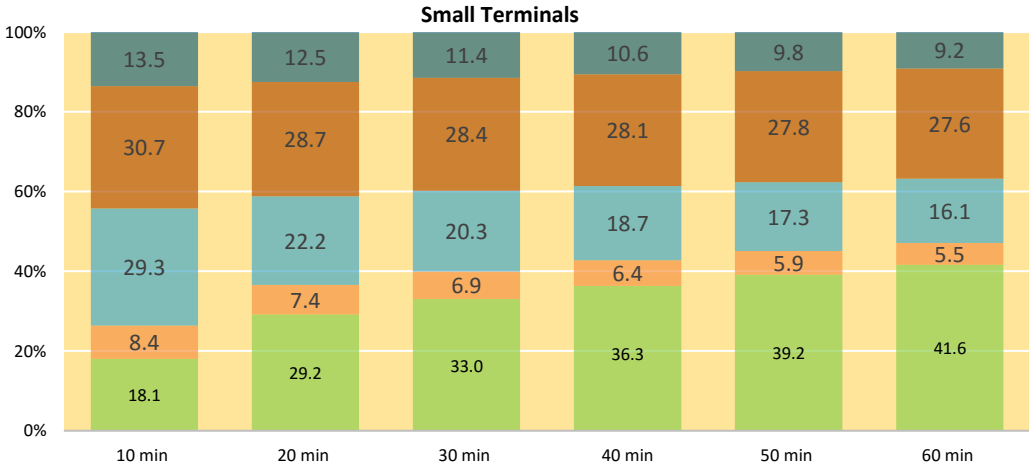

For all terminal sizes, increasing layover time, leads to increasing bus accumulation which leads to increased bus parking area requirement. This results in reduction of percentage of site area under other different functions.

Percentage of car/private vehicle parking area increases significantly for large and medium bus terminals, over small terminals. This is to accommodate increased demand from commercial/real estate development, taken up for these terminal sizes in order to offset the cost of infrastructure development.

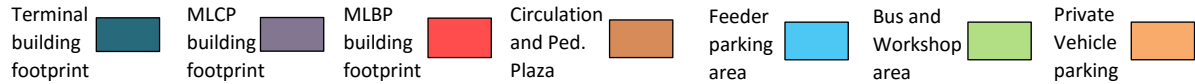

* The values represented here correspond 60 buses per hour for small terminal, 150 buses per hour for medium terminal and 390 buses per hour for large terminals.

Scenario -2 : With Real estate Development and at-grade Parking (Car & Bus)

Typology	Inter state	A
Operation	Fixed Route Bay	a

Open Area Distribution

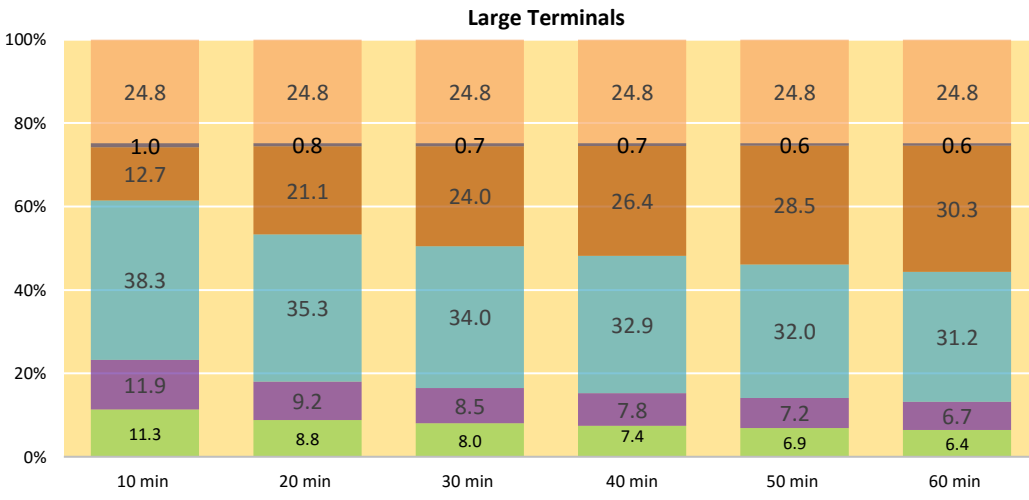
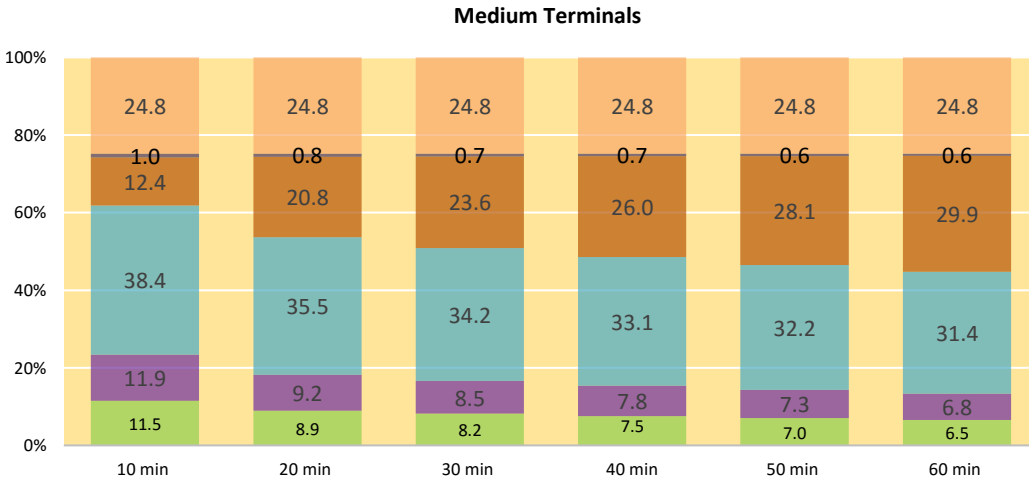
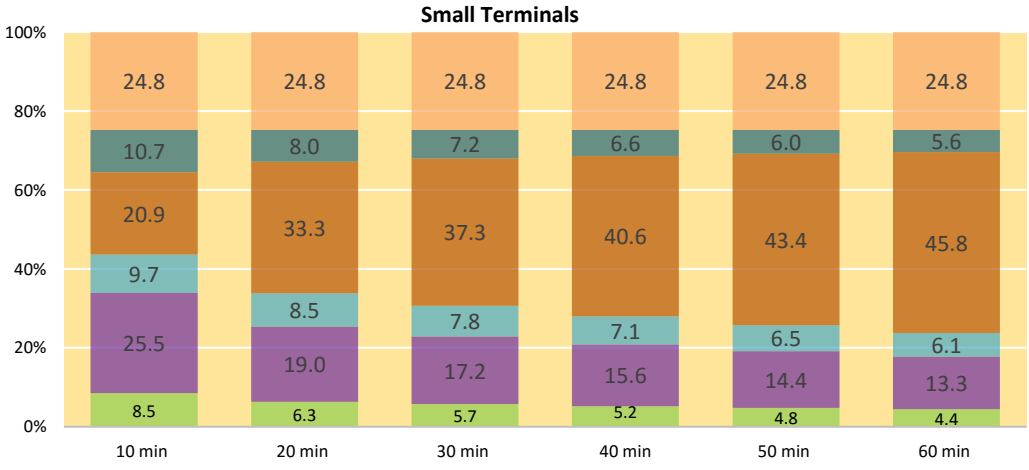

For all terminal sizes, increasing layover time, leads to increasing bus accumulation which leads to increased bus parking area requirement. This results in reduction of percentage of open area under other different functions.

Small terminals have significantly lower area dedicated to car/private vehicle parking as compared to medium and large terminals. This is because car parking requirement surges due to demand for real estate development to offset the cost of medium and large terminal development.

Drop Off █ Pick up █ Car Parking █ Bus Parking █ Circulation area █ Workshop area █ Pedestrian plaza █

* The values represented here correspond 60 buses per hour for small terminal, 150 buses per hour for medium terminal and 390 buses per hour for large terminals.

Spatial Requirements

Aa

Typology	Inter State	A
Operation	Fixed Route Bay	a

Scenario -3 : With Real Estate development, Multilevel (Ramp) Car and (At grade) Bus parking.

Site Area Distribution

Small Terminals

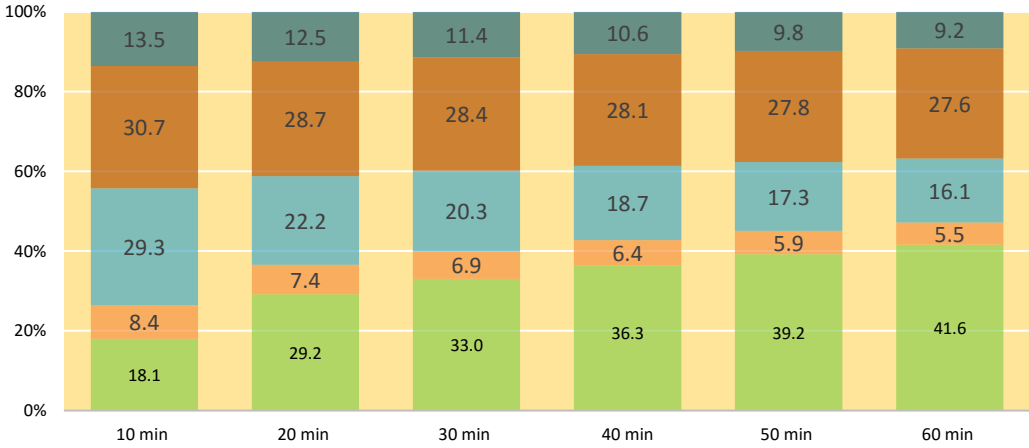

Medium Terminals

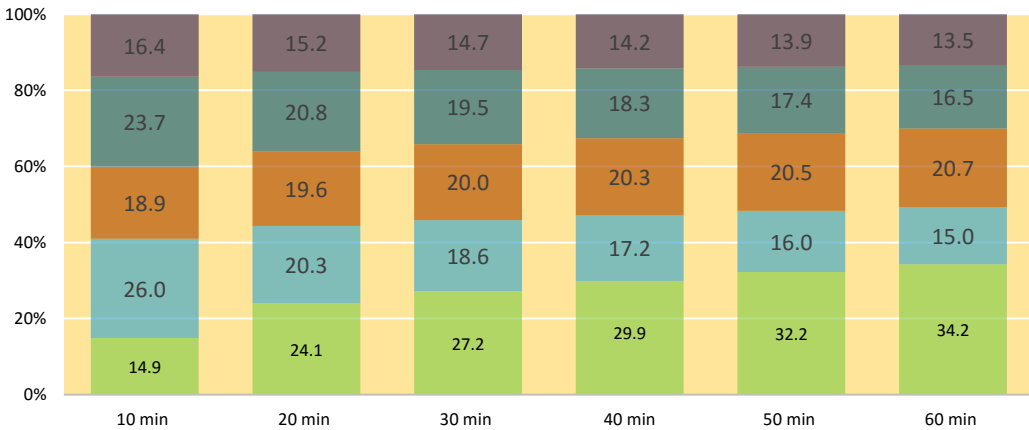

Large Terminals

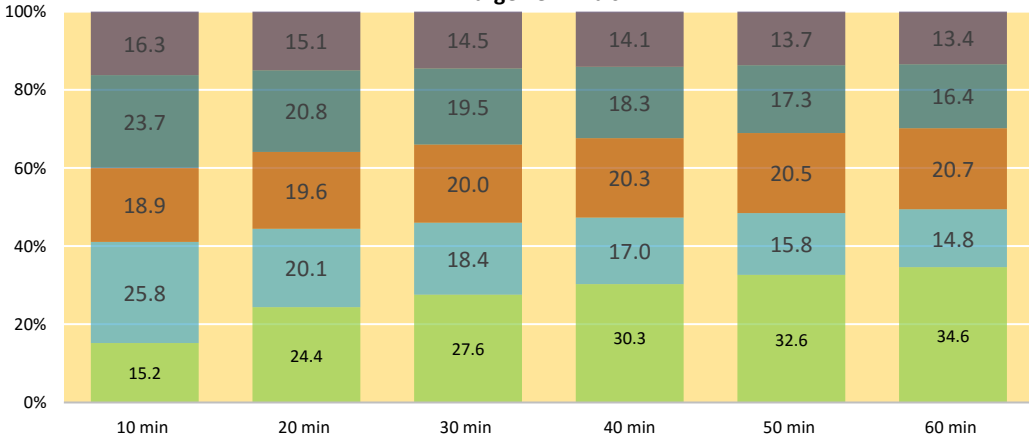

For all terminal sizes, increasing layover time, leads to increasing bus accumulation which leads to increased bus parking area requirement. This results in reduction of percentage of site area under other different functions.

In this scenario, multi level car parking (MLCP) replaces at grade private vehicle parking in medium and large terminals. This is because for these terminal sizes car parking demand exceeds the minimum threshold requirement of 120 for a MLCP.

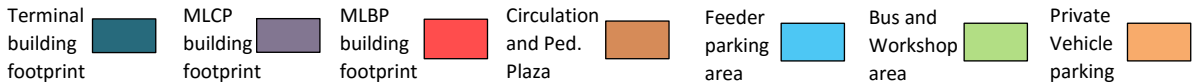

* The values represented here correspond 60 buses per hour for small terminal, 150 buses per hour for medium terminal and 390 buses per hour for large terminals.

Scenario -3 : With Real Estate development, Multilevel (Ramp) Car and (At grade) Bus parking.

Typology	Inter state	A
Operation	Fixed Route Bay	a

Open Area Distribution

Small Terminals

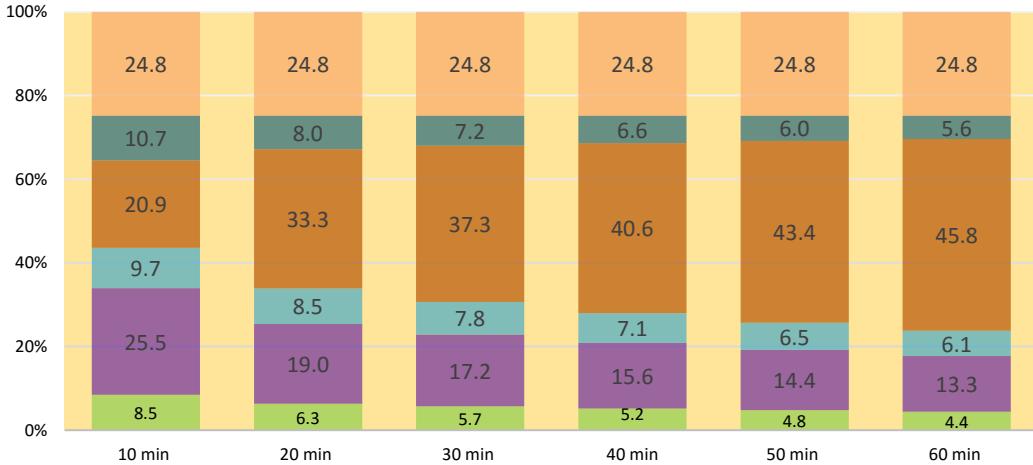

Medium Terminals

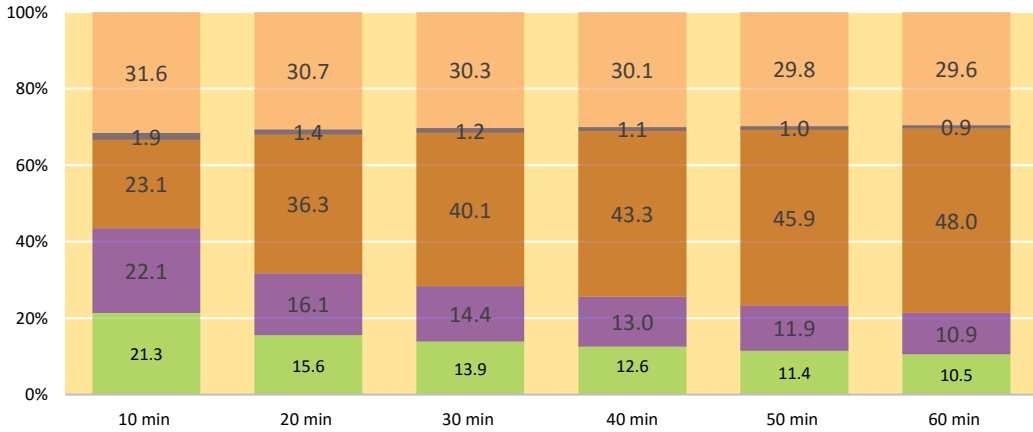

Large Terminals

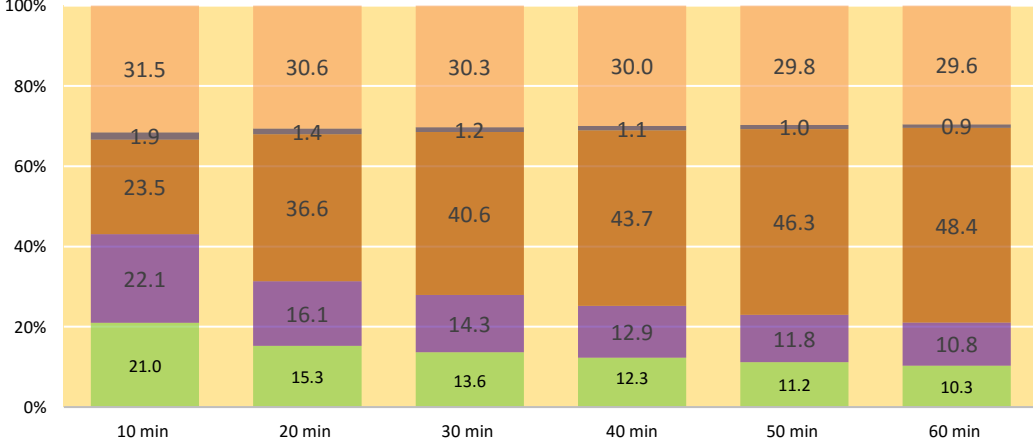

For all terminal sizes, increasing layover time, leads to increasing bus accumulation which leads to increased bus parking area requirement. This results in reduction of percentage of open area under other different functions.

Percentage of open area dedicated to car/Private vehicle parking, for large and medium terminals is '0' as for these terminal sizes (in this scenario) structured car parking is proposed.

Drop Off (green) Pick up (purple) Car Parking (light blue) Bus Parking (dark blue) Circulation area (orange) Workshop area (yellow) Pedestrian plaza (grey)

* The values represented here correspond 60 buses per hour for small terminal, 150 buses per hour for medium terminal and 390 buses per hour for large terminals.

Spatial Requirements

Aa

Scenario -4 : With Real Estate development, Multilevel (Mechanical) Car parking and (At grade) Bus parking.

Typology	Inter State	A
Operation	Fixed Route Bay	a

Site Area Distribution

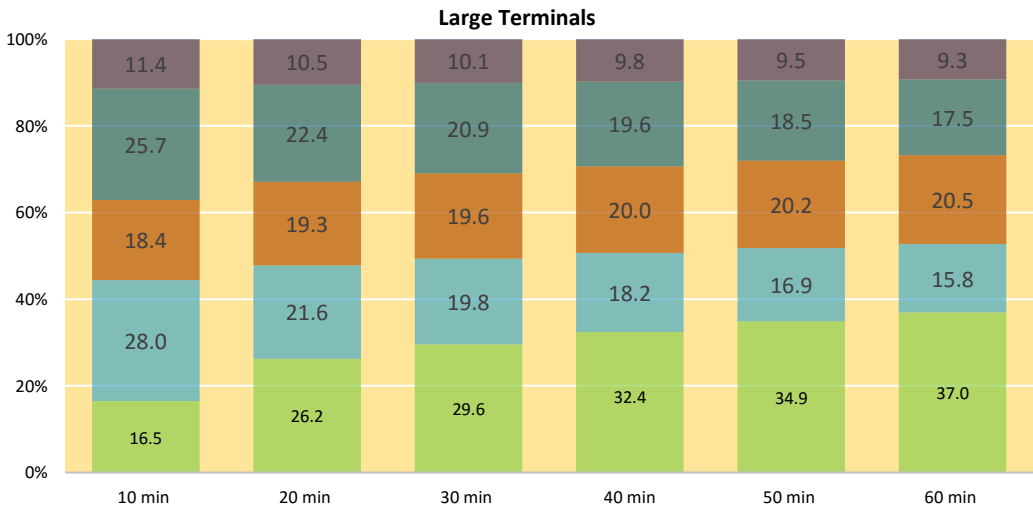
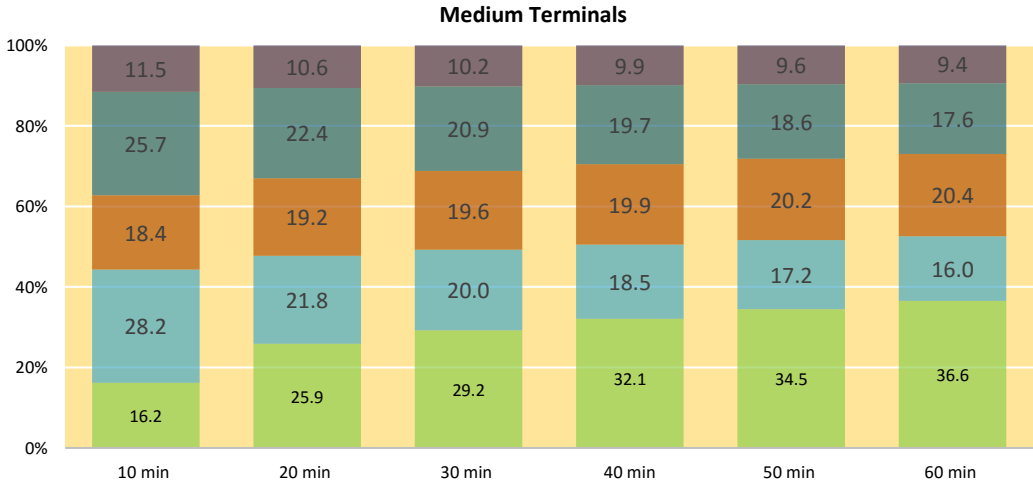
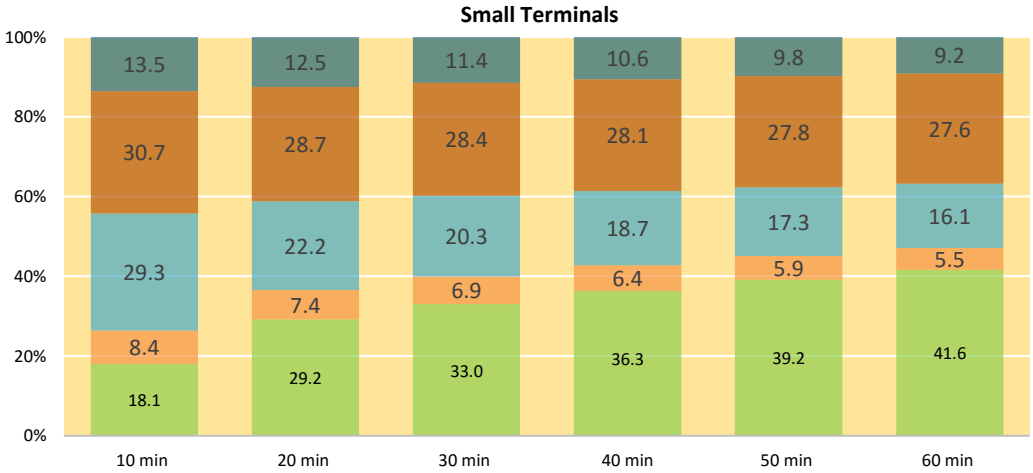

For all terminal sizes, increasing layover time, leads to increasing bus accumulation which leads to increased bus parking area requirement. This results in reduction of percentage of site area under other different functions.

In this scenario, multi level car parking (MLCP) replaces at grade private vehicle parking in medium and large terminals. This is because for these terminal sizes car parking demand exceeds the minimum threshold requirement of 120 for a MLCP.

- Terminal building footprint
- MLCP building footprint
- MLBP building footprint
- Circulation and Ped. Plaza
- Feeder parking area
- Bus and Workshop area
- Private Vehicle parking

* The values represented here correspond 60 buses per hour for small terminal, 150 buses per hour for medium terminal and 390 buses per hour for large terminals.

Scenario -4 : With Real Estate development, Multilevel (Mechanical) Car parking and (At grade) Bus parking.

Typology	Inter State	A
Operation	Fixed Route Bay	a

Open Area Distribution

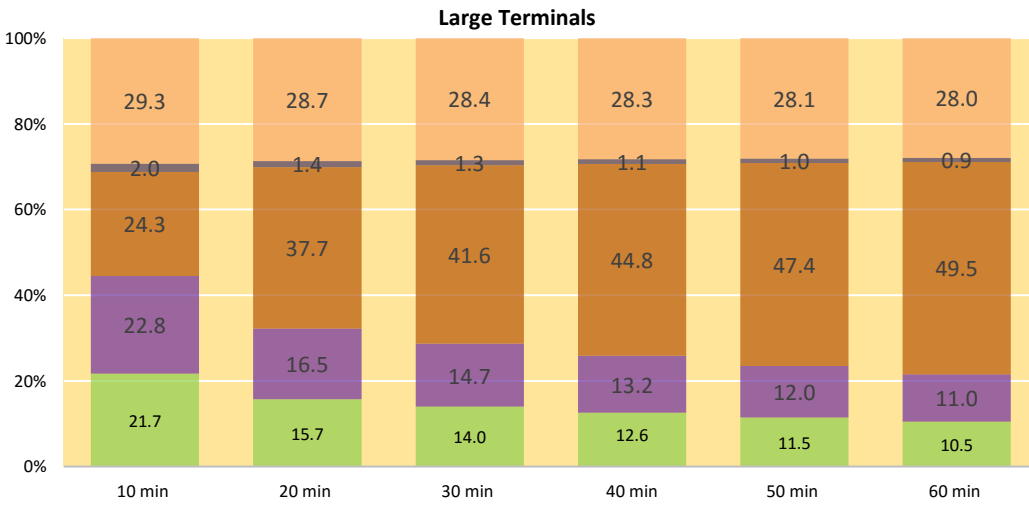
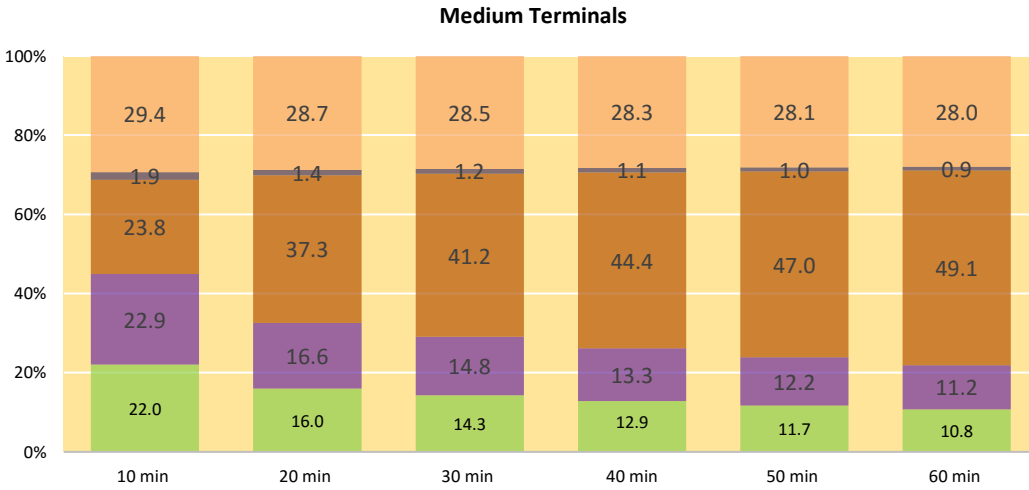
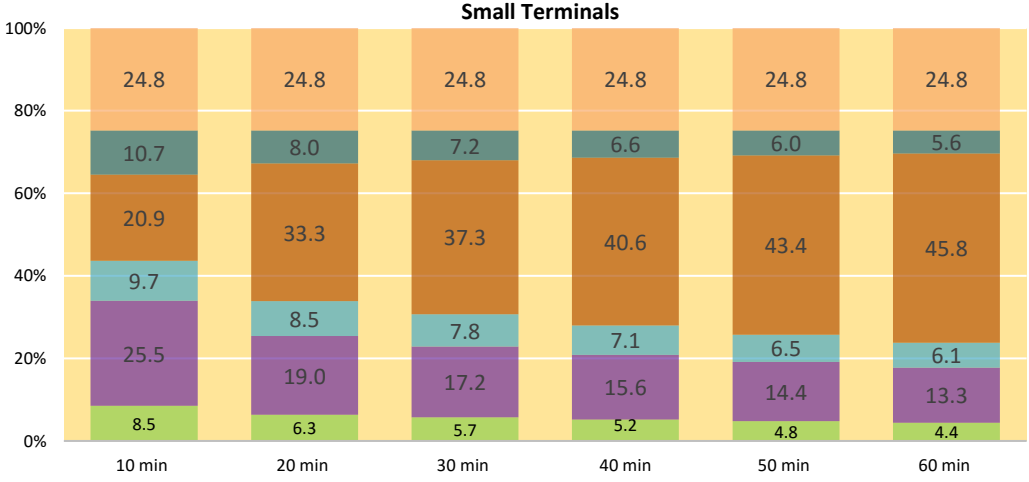

For all terminal sizes, increasing layover time, leads to increasing bus accumulation which leads to increased bus parking area requirement. This results in reduction of percentage of open area under other different functions.

Percentage of open area dedicated to car/Private vehicle parking, for small and medium terminals is '0' as for these terminal sizes (in this scenario) structured car parking is proposed.

Drop Off Pick up Car Parking Bus Parking Circulation area Workshop area Pedestrian plaza

* The values represented here correspond 60 buses per hour for small terminal, 150 buses per hour for medium terminal and 390 buses per hour for large terminals.

Spatial Requirements

Aa

Typology	Inter State	A
Operation	Fixed Route Bay	a

Scenario -5 : With Real Estate development, Multilevel (Ramp) Car parking and Multilevel (Ramp) Bus parking

Site Area Distribution

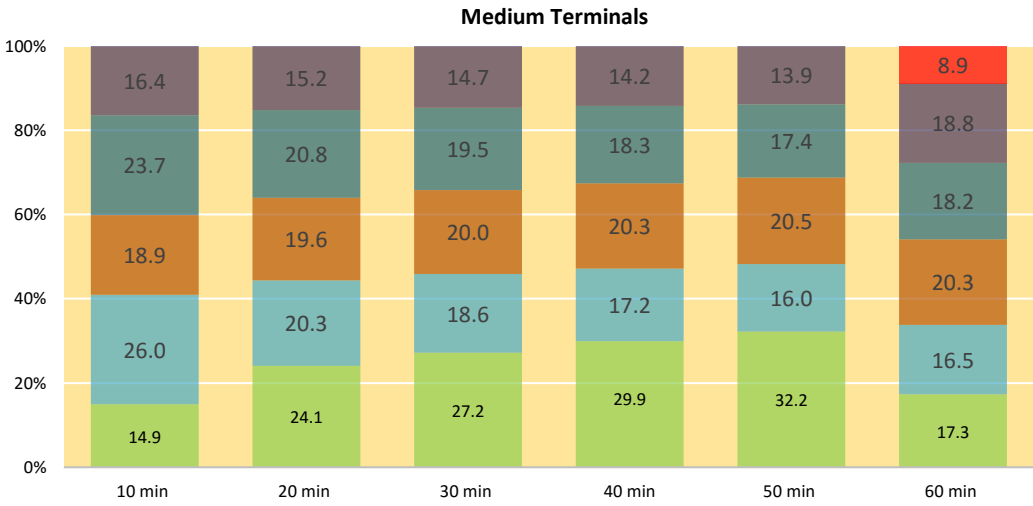
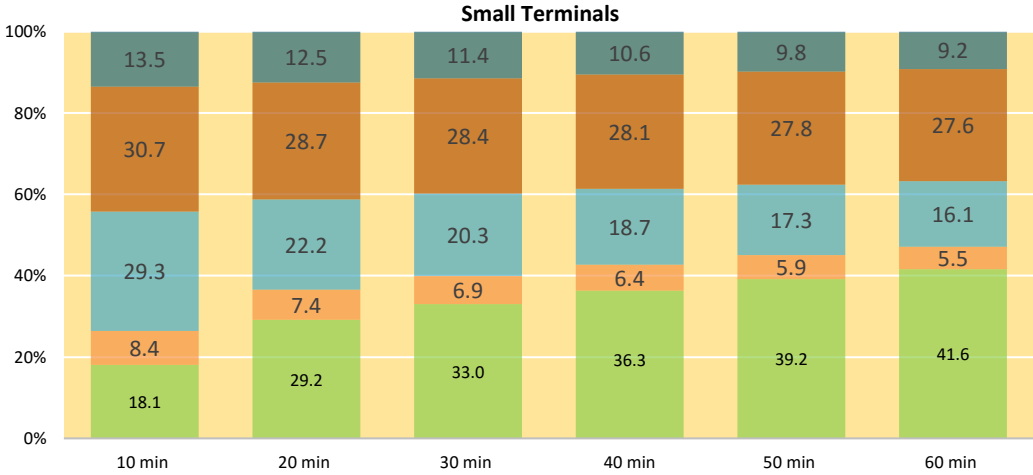

For all terminal sizes, increasing layover time, leads to increasing bus accumulation which leads to increased bus parking area requirement. This results in reduction of percentage of site area under other different functions.

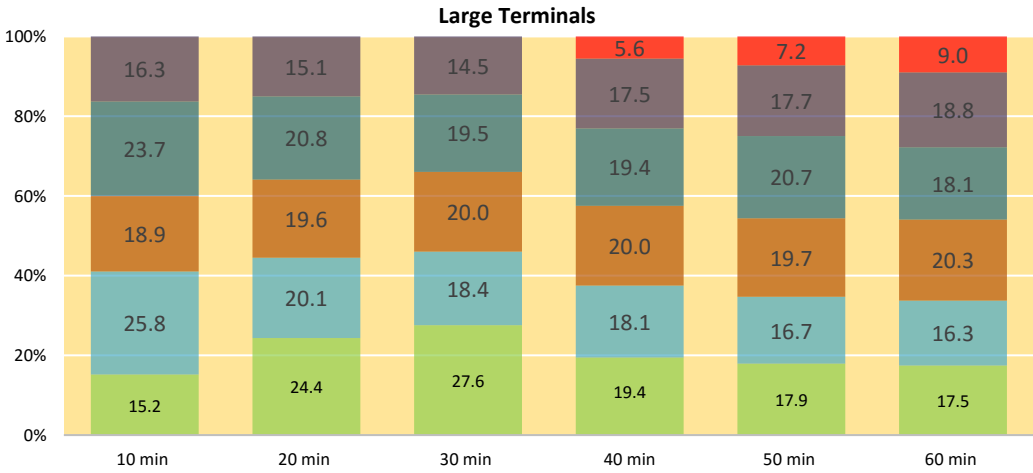

In this scenario, multi level car parking (MLCP) replaces at grade private vehicle parking in medium and large terminals. This is because for these terminal sizes car parking demand exceeds the minimum threshold requirement of 120 for a MLCP.

For layover time 60minutes in medium terminal and layover time 40 to 60 minutes in large terminals, idle bus parking demand exceeds the minimum threshold of 130 buses for a multi level bus parking (MLBP) This leads to introduction of MLBP in these conditions, which results in reduced bus and workshop area.

Terminal building footprint MLCP building footprint MLBP building footprint Circulation and Ped. Plaza Feeder parking area Bus and Workshop area Private Vehicle parking

* The values represented here correspond 60 buses per hour for small terminal, 150 buses per hour for medium terminal and 390 buses per hour for large terminals.

Scenario -5: With Real Estate development, Multilevel (Ramp) Car parking and Multilevel (Ramp) Bus parking

Typology	Inter State	A
Operation	Fixed Route Bay	a

Open Area Distribution

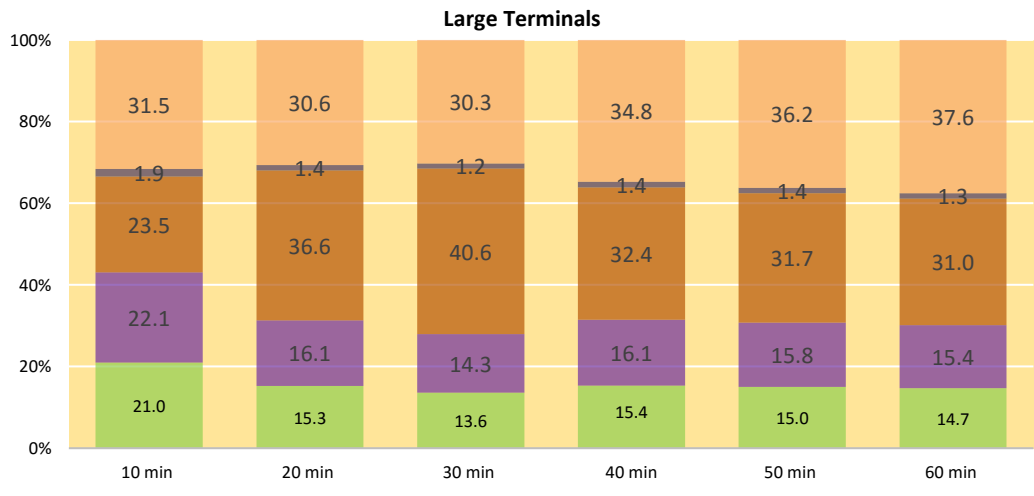
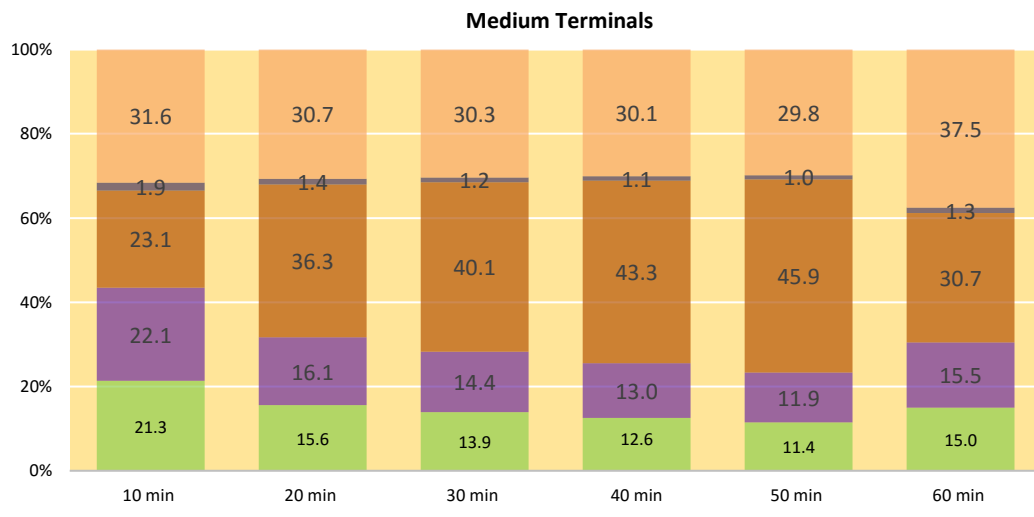
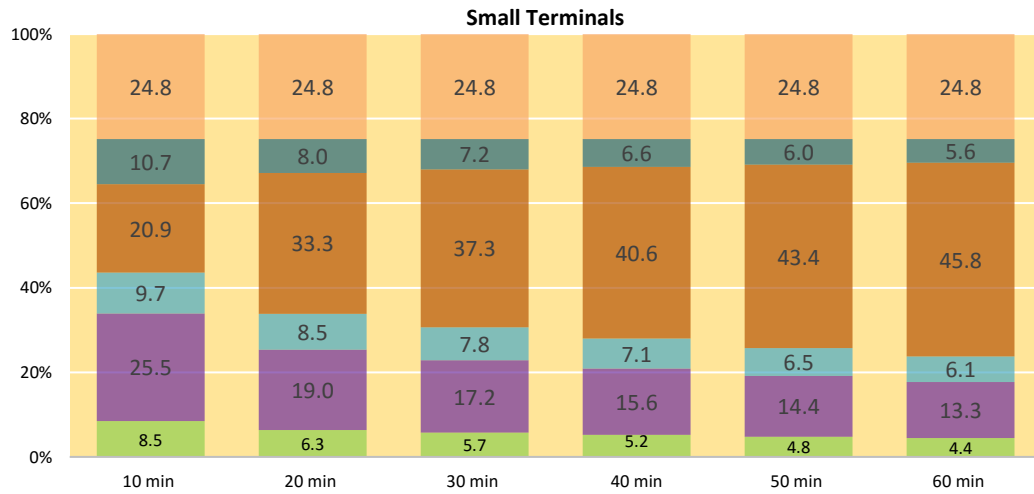

For all terminal sizes, increasing layover time, leads to increasing bus accumulation which leads to increased bus parking area requirement. This results in reduction of percentage of open area under other different functions.

In this scenario, at layover time of 40 minutes for medium terminals and 40 to 60 minutes for large terminals, idle bus parking demand exceeds 130. At this threshold idle bus parking is accommodated in structured parking lot, which eliminates idle parking requirement, leading to a drop in percentage open area under 'bus area' (loading and unloading bays are a part of bus area).

Drop Off █ Pick up █ Car Parking █ Bus Parking █ Circulation area █ Workshop area █ Pedestrian plaza █

* The values represented here correspond 60 buses per hour for small terminal, 150 buses per hour for medium terminal and 390 buses per hour for large terminals.

Spatial Requirements

Aa

Typology	Inter State	A
Operation	Fixed Route Bay	a

Scenario -6 : With Real Estate development, Multilevel (Mechanical) Car parking and Multilevel (Ramp) Bus parking

Site Area Distribution

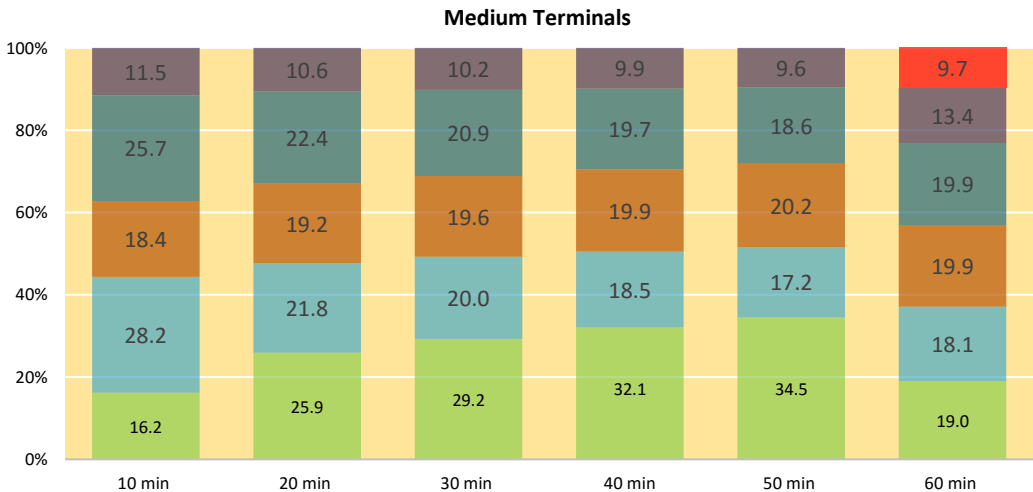
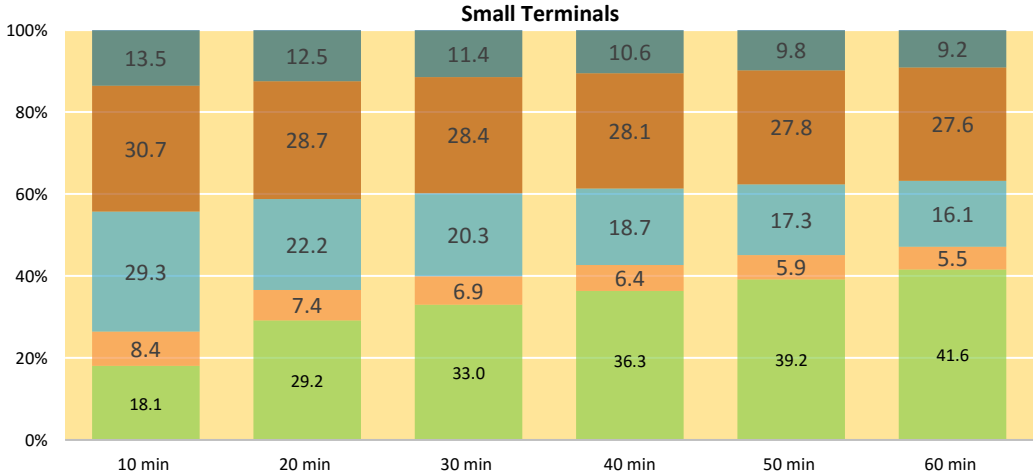

For all terminal sizes, increasing layover time, leads to increasing bus accumulation which leads to increased bus parking area requirement. This results in reduction of percentage of site area under other different functions.

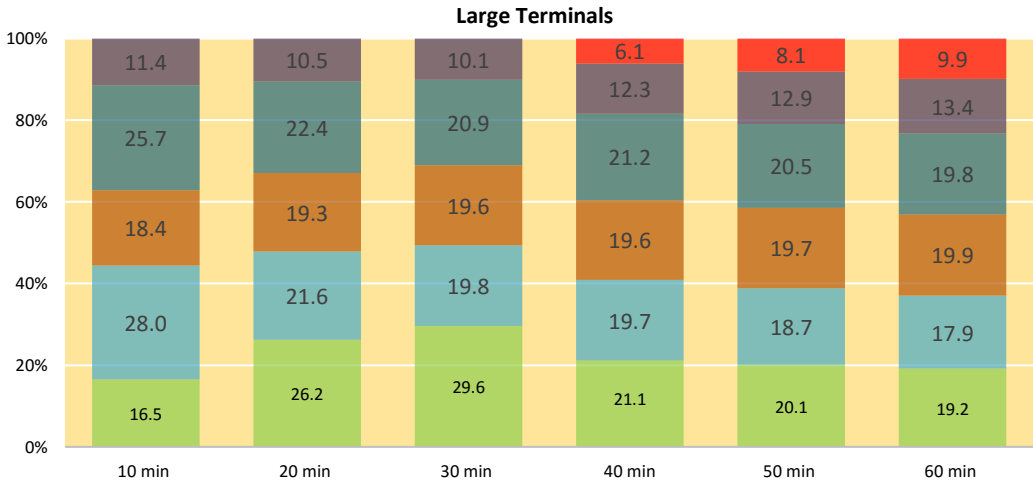

In this scenario, multi level car parking (MLCP) replaces at grade private vehicle parking in medium and large terminals. This is because for these terminal sizes car parking demand exceeds the minimum threshold requirement of 120 for a MLCP.

For layover time 60minutes in medium terminal and layover time 40 to 60 minutes in large terminals, idle bus parking demand exceeds the minimum threshold of 130 buses for a multi level bus parking (MLBP) This leads to introduction of MLBP in these conditions, which results in reduced bus and workshop area.

Terminal building footprint MLCP building footprint MLBP building footprint Circulation and Ped. Plaza Feeder parking area Bus and Workshop area Private Vehicle parking

* The values represented here correspond 60 buses per hour for small terminal, 150 buses per hour for medium terminal and 390 buses per hour for large terminals.

Scenario -6 : With Real Estate development, Multilevel (Mechanical) Car parking and Multilevel (Ramp) Bus parking

Typology	Inter State	A
Operation	Fixed Route Bay	a

Open Area Distribution

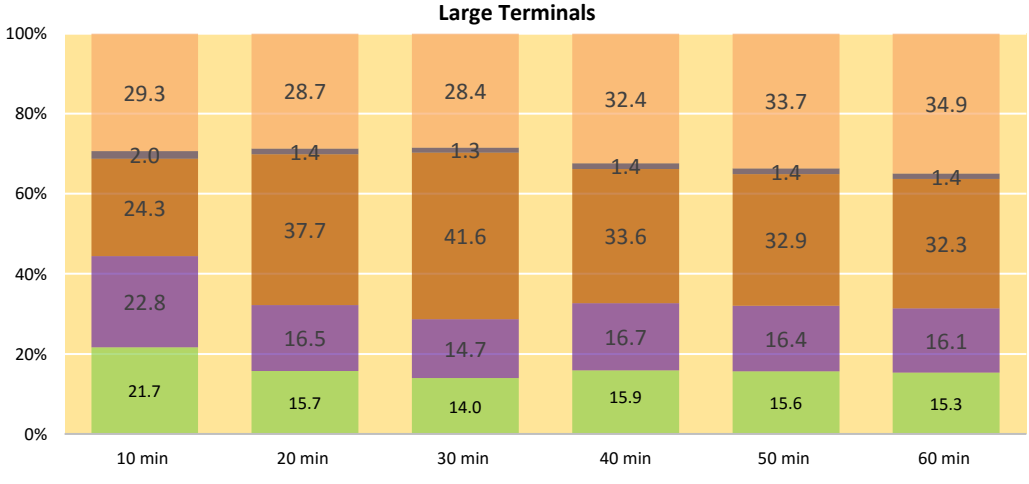
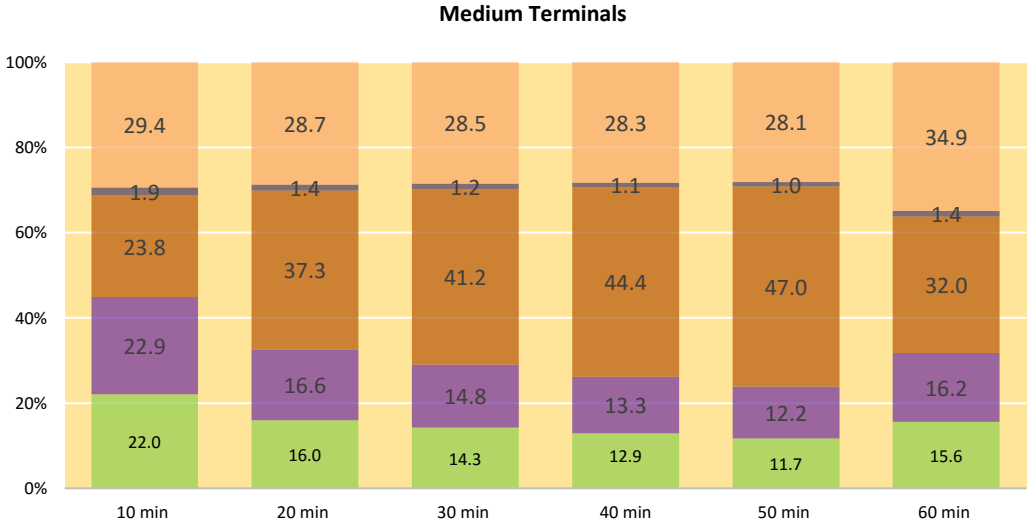
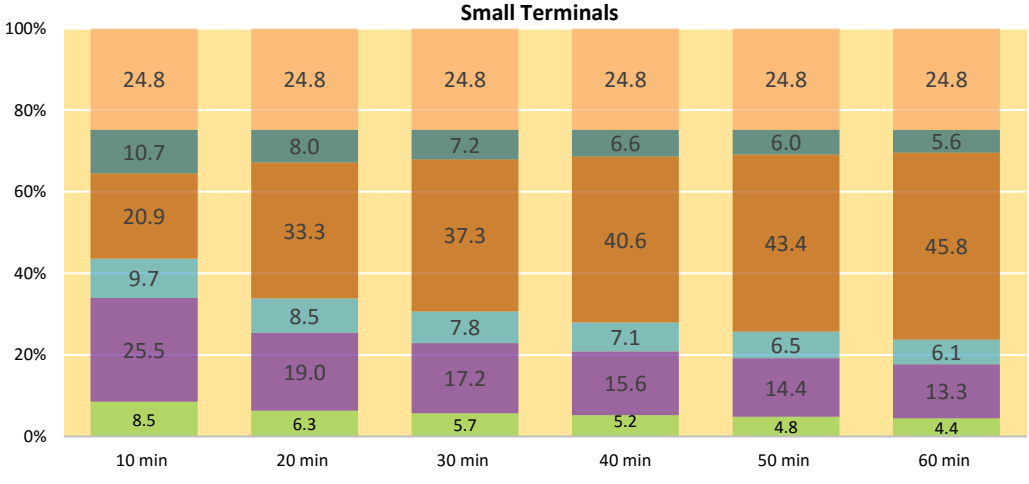

For all terminal sizes, increasing layover time, leads to increasing bus accumulation which leads to increased bus parking area requirement. This results in reduction of percentage of open area under other different functions.

In this scenario, at layover time of 40 minutes for medium terminals and 40 to 60 minutes for large terminals, idle bus parking demand exceeds 130. At this threshold idle bus parking is accommodated in structured parking lot, which eliminates idle parking requirement, leading to a drop in percentage open area under 'bus area' (loading and unloading bays are a part of bus area).

Drop Off (Green), Pick up (Purple), Car Parking (Light Blue), Bus Parking (Dark Blue), Circulation area (Orange), Workshop area (Yellow), Pedestrian plaza (Grey), Other (Dark Green)

* The values represented here correspond 60 buses per hour for small terminal, 150 buses per hour for medium terminal and 390 buses per hour for large terminals.

Spatial Requirements

Aa

Scenario - 7 : With Real estate Development, Basement Car parking & at grade Bus Parking.

Typology	Inter state	A
Operation	Fixed Route Bay	a

Site Area Distribution

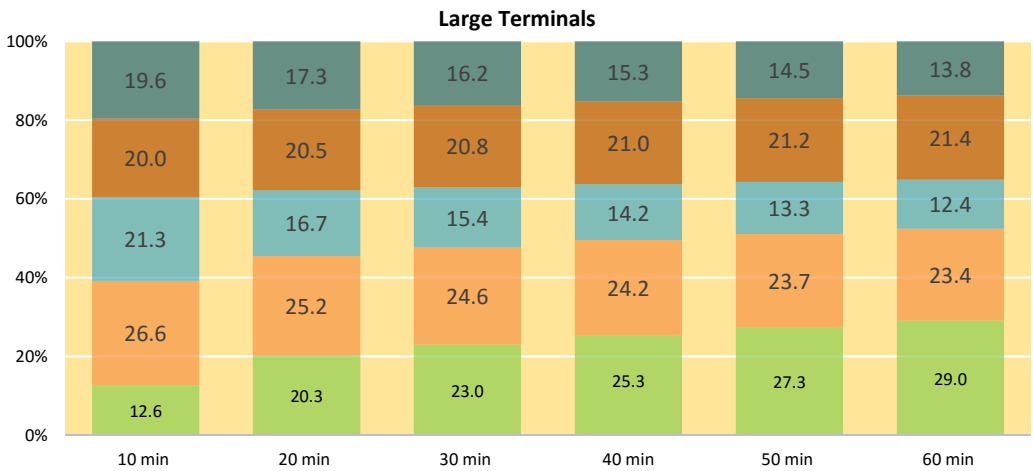
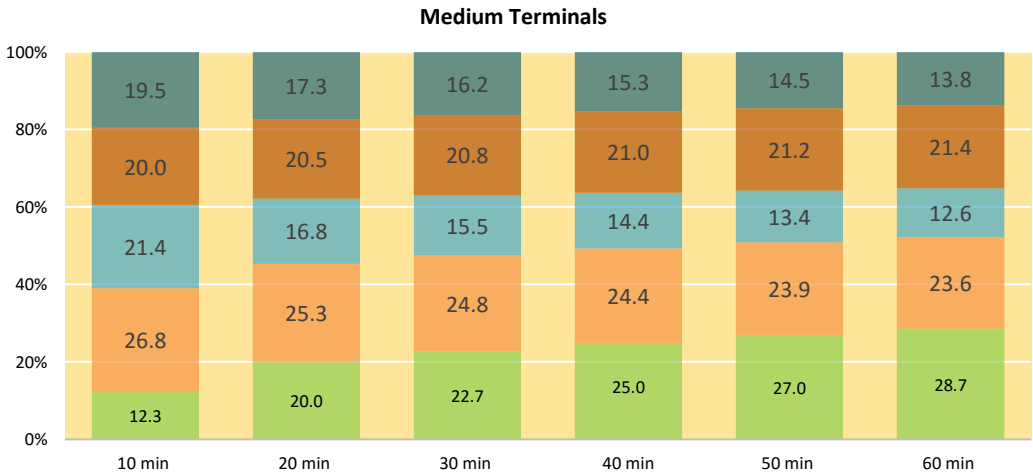
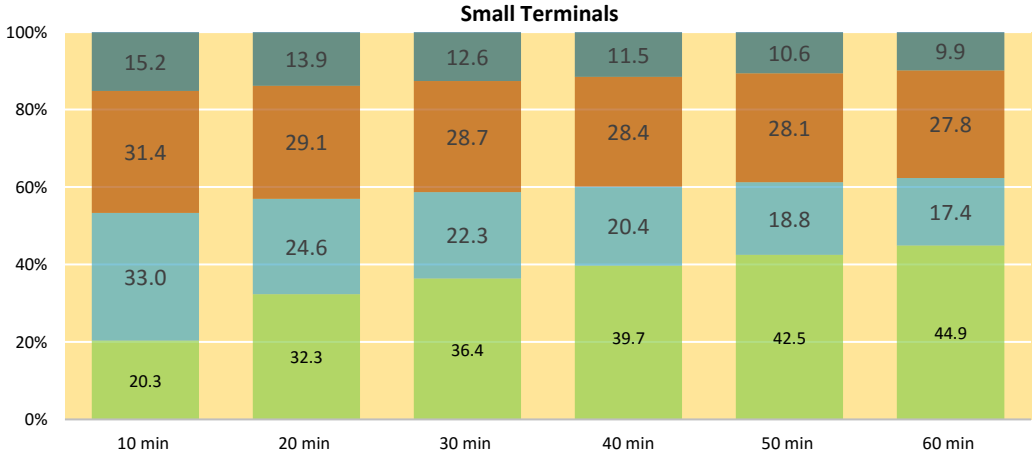

For all terminal sizes, increasing layover time, leads to increasing bus accumulation which leads to increased bus parking area requirement. This results in reduction of percentage of site area under other different functions.

In this scenario, two levels of basement car parking under the terminal building is introduced. This replaces at grade private vehicle parking in small terminals but does not possess enough capacity to accommodate private vehicle parking demand in medium and large terminals with real estate development. This results in significant area being allocated to additional at grade private vehicle parking for these two terminal sizes.

Terminal building footprint MLCP building footprint MLBP building footprint Circulation and Ped. Plaza Feeder parking area Bus and Workshop area Private Vehicle parking

* The values represented here correspond 60 buses per hour for small terminal, 150 buses per hour for medium terminal and 390 buses per hour for large terminals.

Scenario - 7 : With Real estate Development, Basement Car parking & at grade Bus Parking.

Typology	Inter State	A
Operation	Fixed Route Bay	a

Open Area Distribution

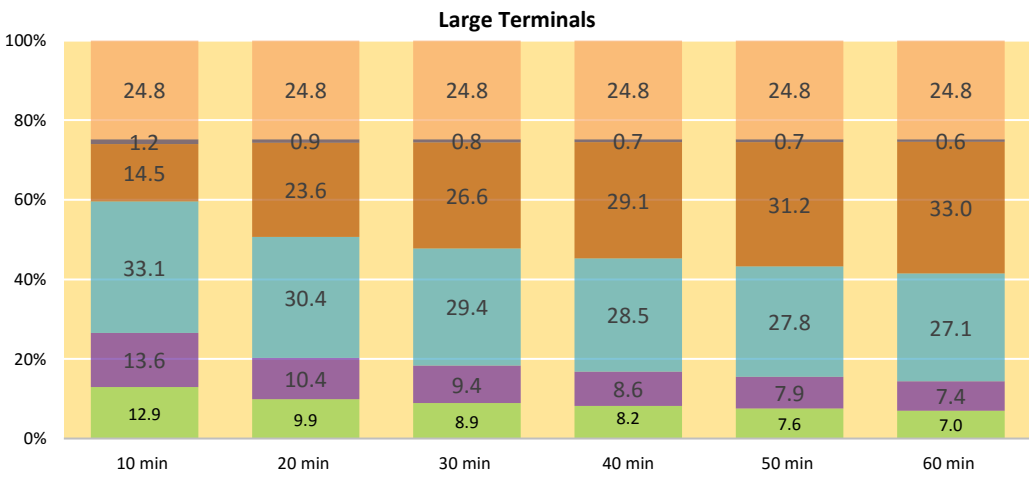
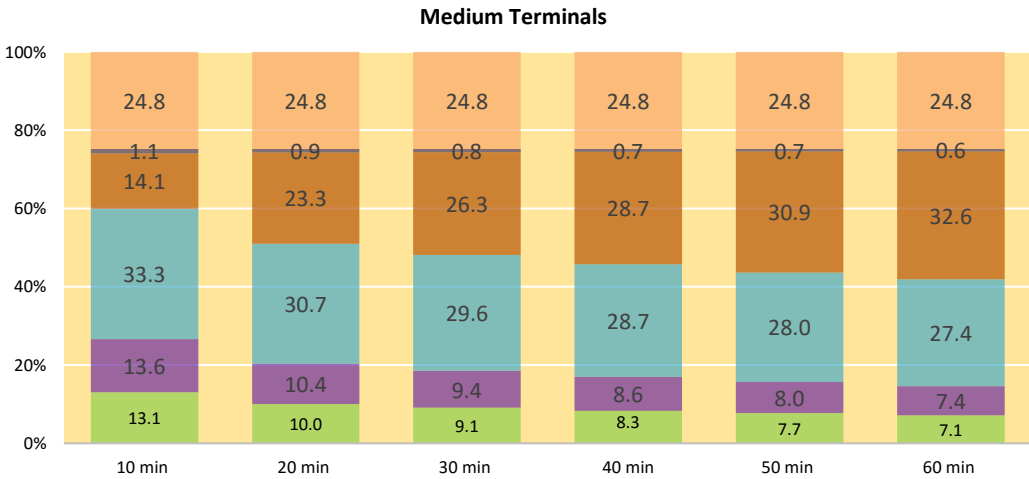
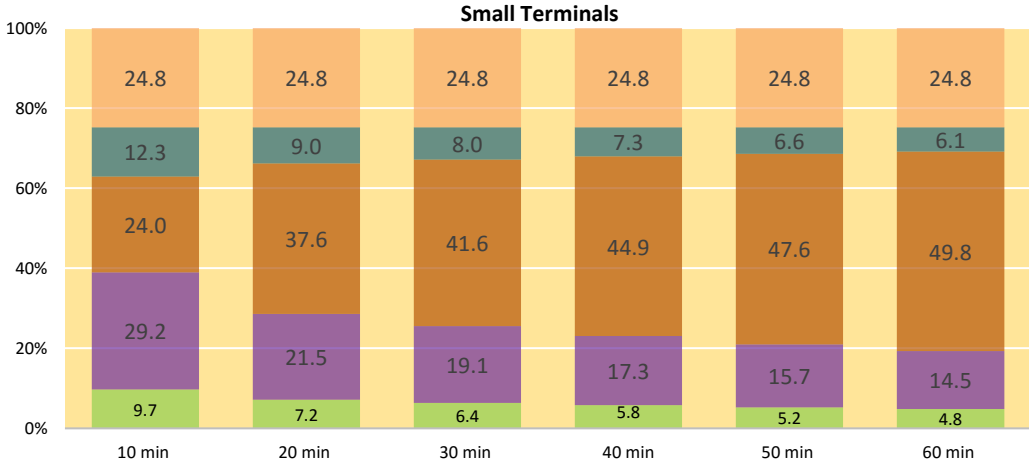

For all terminal sizes, increasing layover time, leads to increasing bus accumulation which leads to increased bus parking area requirement. This results in reduction of percentage of open area under other different functions.
The basement level parking is limited to two floors under the terminal building. This can accommodate only a part of the total parking demand for medium and large terminals. The rest of the vehicles are accommodated in the surface parking.

Drop Off █ Pick up █ Car Parking █ Bus Parking █ Circulation area █ Workshop area █ Pedestrian plaza █

* The values represented here correspond 60 buses per hour for small terminal, 150 buses per hour for medium terminal and 390 buses per hour for large terminals.

Spatial Requirements

Ab

Scenario -1: Without Real estate Development (No commercial) and at grade car & Bus Parking.

Typology	Inter State	A
Operation	Dynamic Bay	b

Site Area Distribution

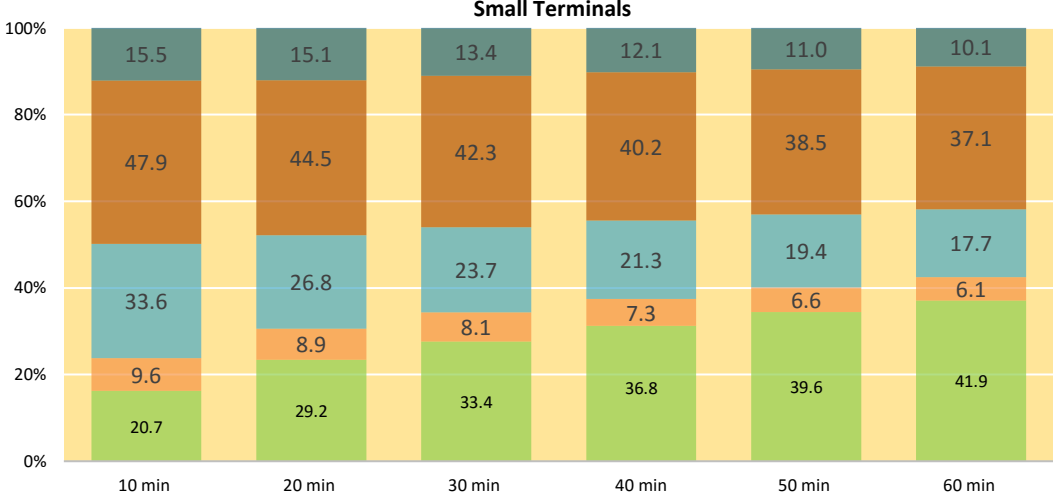

Medium Terminals

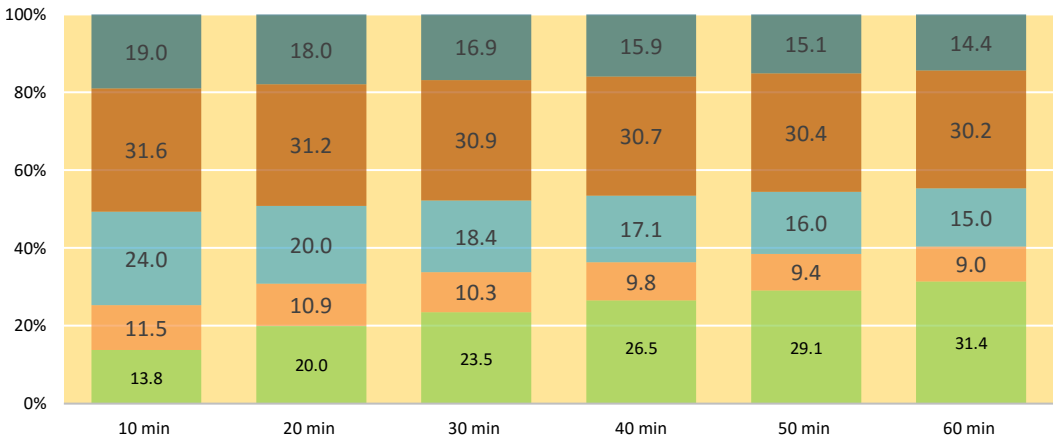

Large Terminals

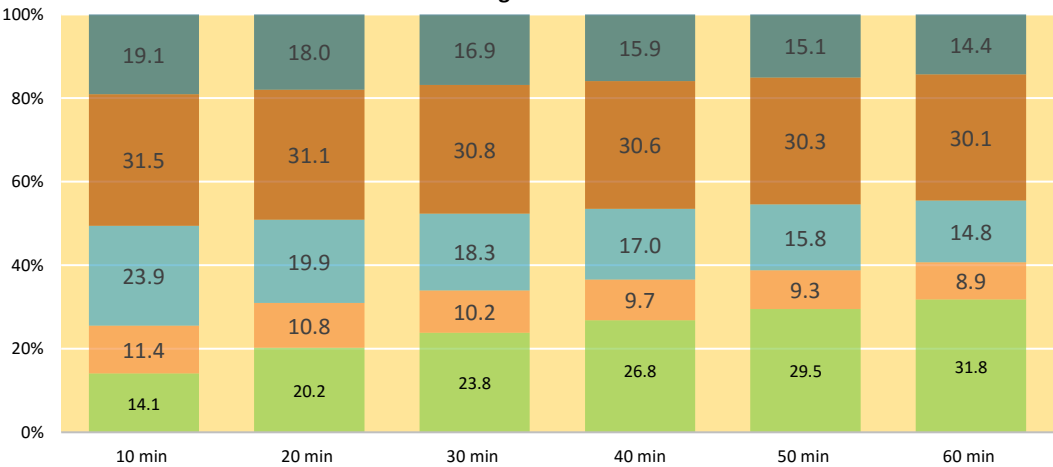

For all terminal sizes, increasing llover time, leads to increasing bus accumulation which leads to increased bus parking area requirement. This results in reduction of percentage of site area under other different functions

- Terminal building footprint
- MLCP building footprint
- MLBP building footprint
- Circulation and Ped. Plaza
- Feeder parking area
- Bus and Workshop area
- Private Vehicle parking

* The values represented here correspond 60 buses per hour for small terminal, 150 buses per hour for medium terminal and 390 buses per hour for large terminals.

Scenario -1: Without Real estate Development (No commercial) and at grade car & Bus Parking.

Typology	Inter State	B
Operation	Dynamic Bay	b

Open Area Distribution

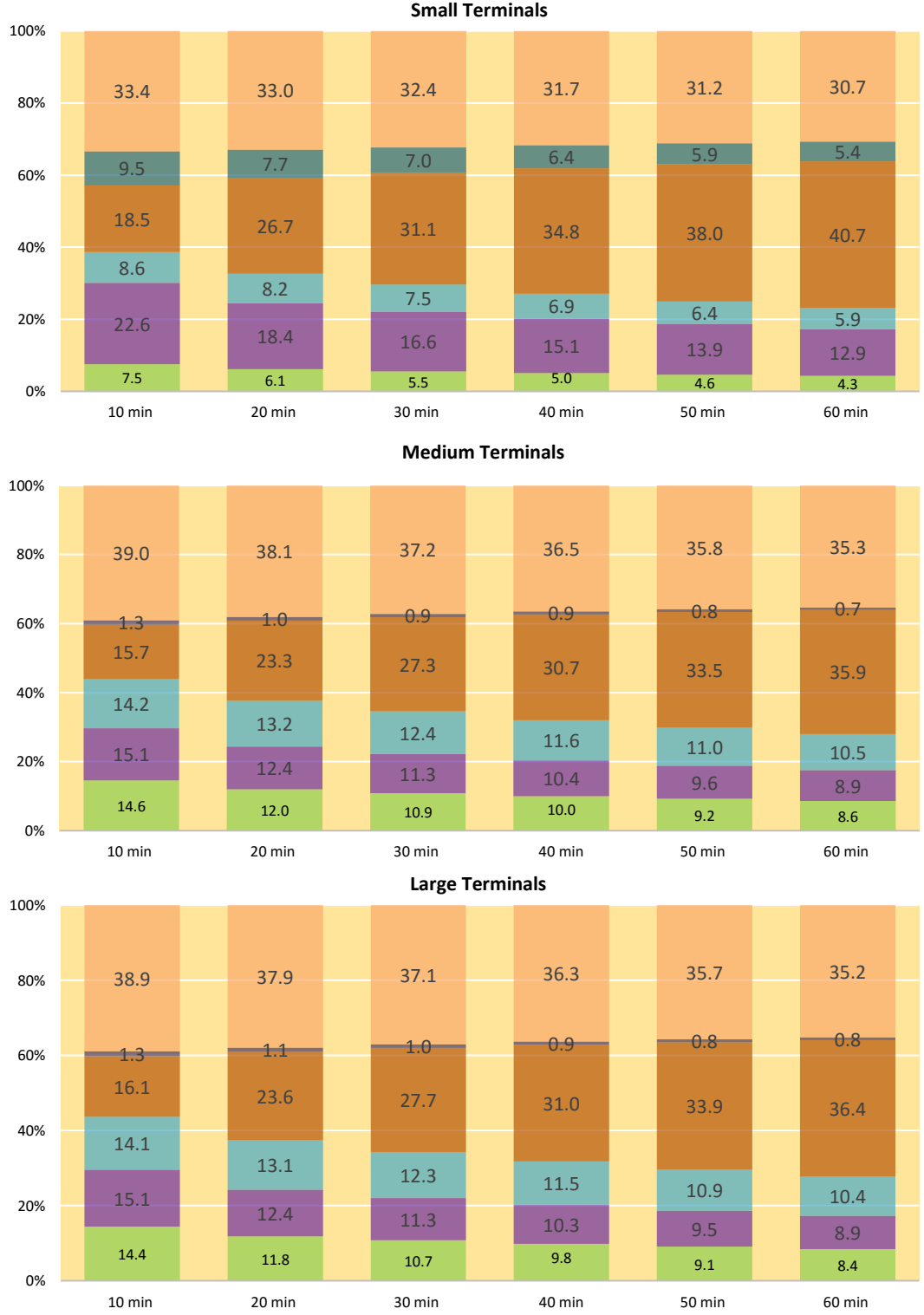

For all terminal sizes, increasing layover time, leads to increasing bus accumulation which leads to increased bus parking area requirement. This results in reduction of percentage of open area under other different functions.

Drop Off █ Pick up █ Car Parking █ Bus Parking █ Circulation area █ Workshop area █ Pedestrian plaza █

* The values represented here correspond 60 buses per hour for small terminal, 150 buses per hour for medium terminal and 390 buses per hour for large terminals.

Spatial Requirements

Scenario-2 : With Real estate Development, at-grade Parking (Car & Bus).

Ab

Typology	Inter State	A
Operation	Dynamic Bay	b

Site Area Distribution

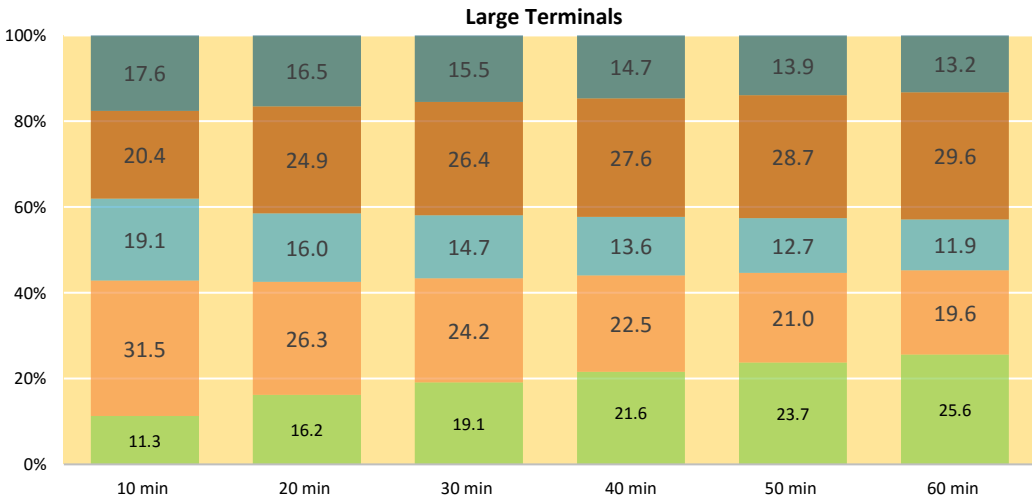
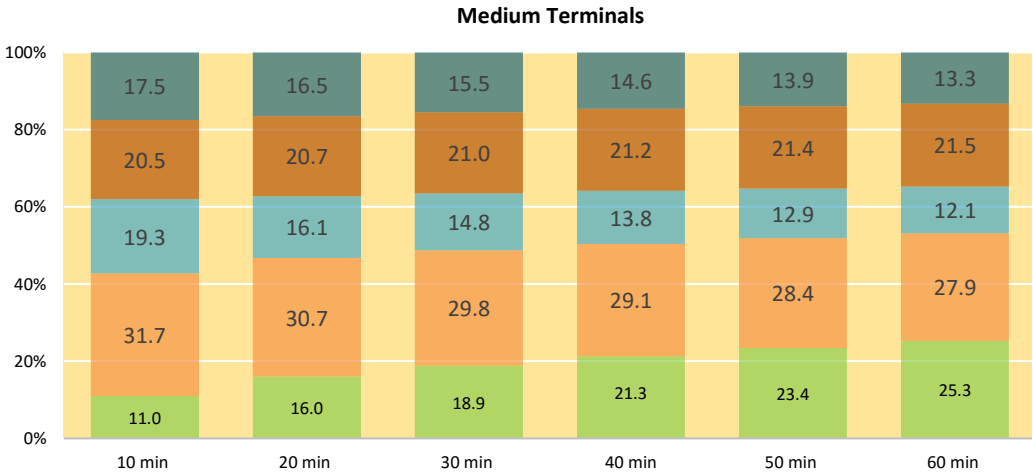
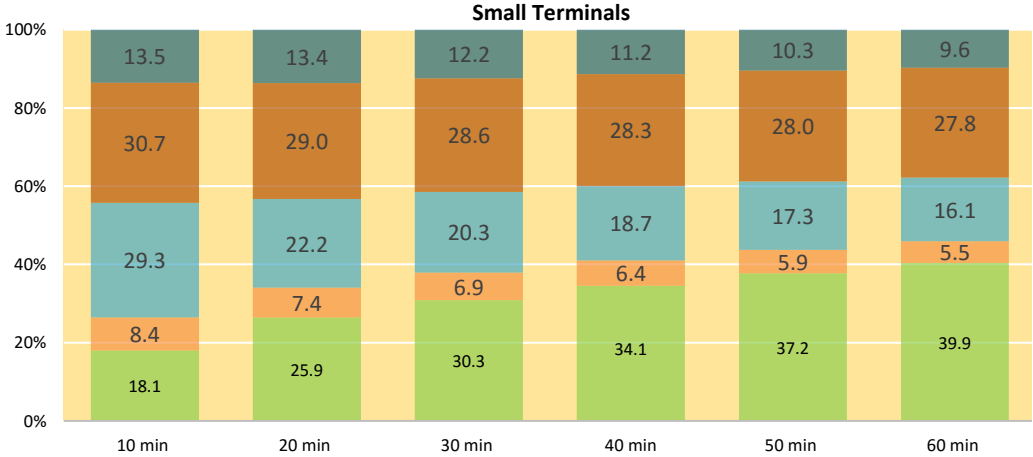

For all terminal sizes, increasing llover time, leads to increasing bus accumulation which leads to increased bus parking area requirement. This results in reduction of percentage of site area under other different functions.

Percentage of car/private vehicle parking area increases significantly for large and medium bus terminals, over small terminals. This is to accommodate increased demand from commercial/real estate development, taken up for these terminal sizes in order to offset the cost of infrastructure development.

- Terminal building footprint
- MLCP building footprint
- MLBP building footprint
- Circulation and Ped. Plaza
- Feeder parking area
- Bus and Workshop area
- Private Vehicle parking

* The values represented here correspond 60 buses per hour for small terminal, 150 buses per hour for medium terminal and 390 buses per hour for large terminals.

Scenario-2 : With Real estate Development, at-grade Parking (Car & Bus).

Typology	Inter state	A
Operation	Dynamic Bay	b

Open Area Distribution

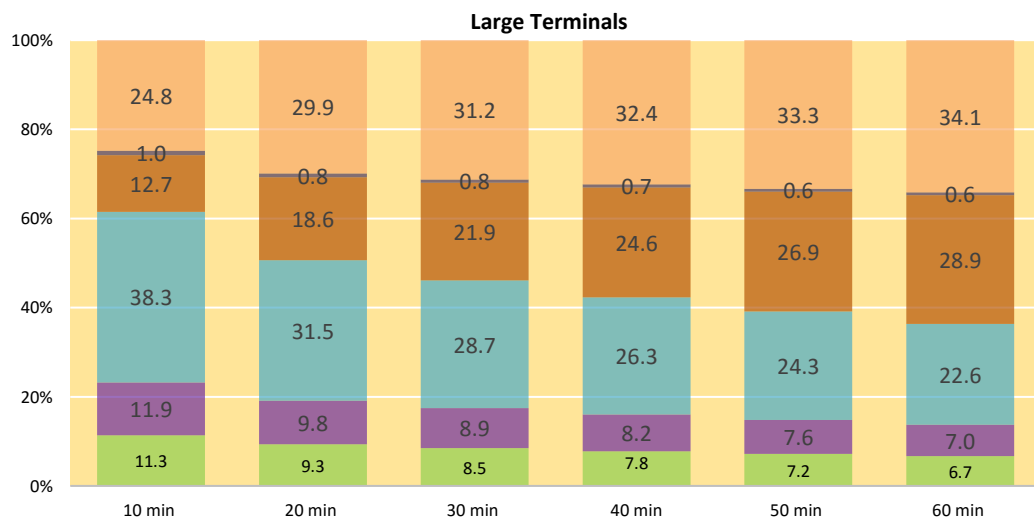
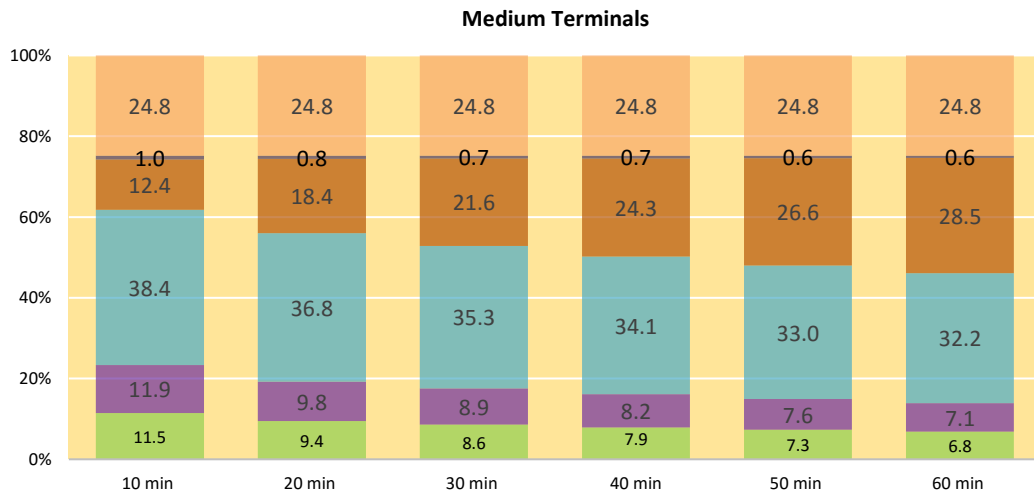
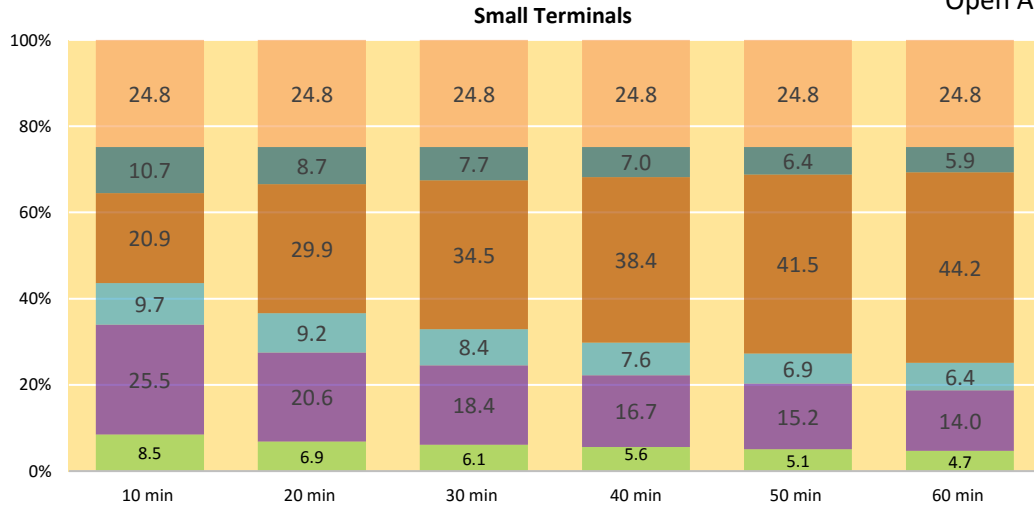

For all terminal sizes, increasing layover time, leads to increasing bus accumulation which leads to increased bus parking area requirement. This results in reduction of percentage of open area under other different functions.

Small terminals have significantly lower area dedicated to car/private vehicle parking as compared to medium and large terminals. This is because car parking requirement surges due to demand for real estate development to offset the cost of medium and large terminal development.

Drop Off (yellow) Pick up (green) Car Parking (purple) Bus Parking (teal) Circulation area (brown) Workshop area (orange) Pedestrian plaza (dark teal)

* The values represented here correspond 60 buses per hour for small terminal, 150 buses per hour for medium terminal and 390 buses per hour for large terminals.

Spatial Requirements

Ab

Scenario -3 : With Real Estate development, Multilevel (Ramp) Car and (At grade) Bus parking.

Typology	Inter State	A
Operation	Dynamic Bay	b

Site Area Distribution

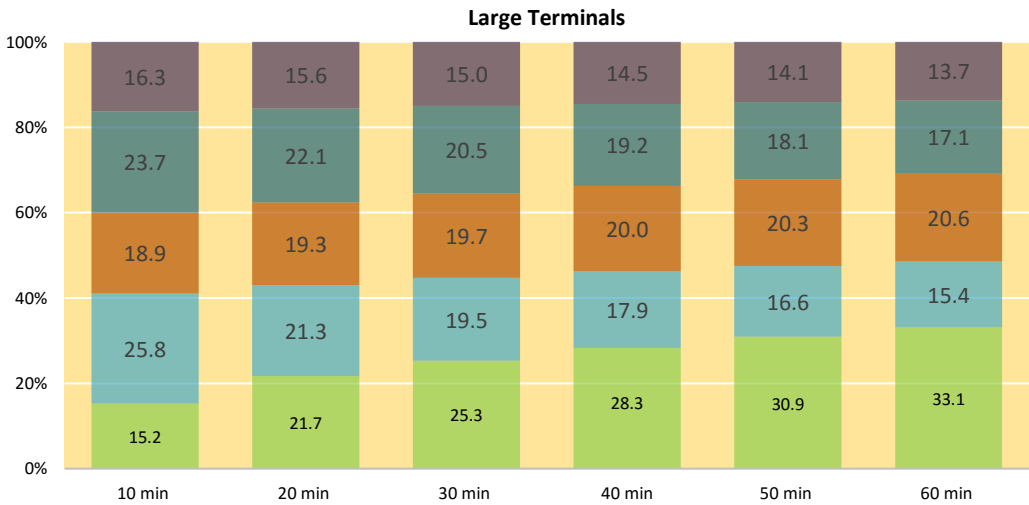
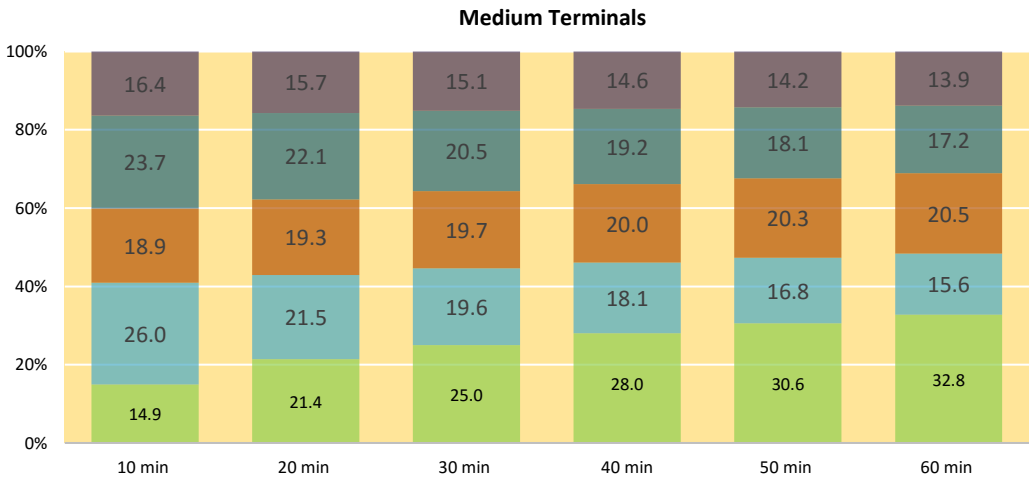
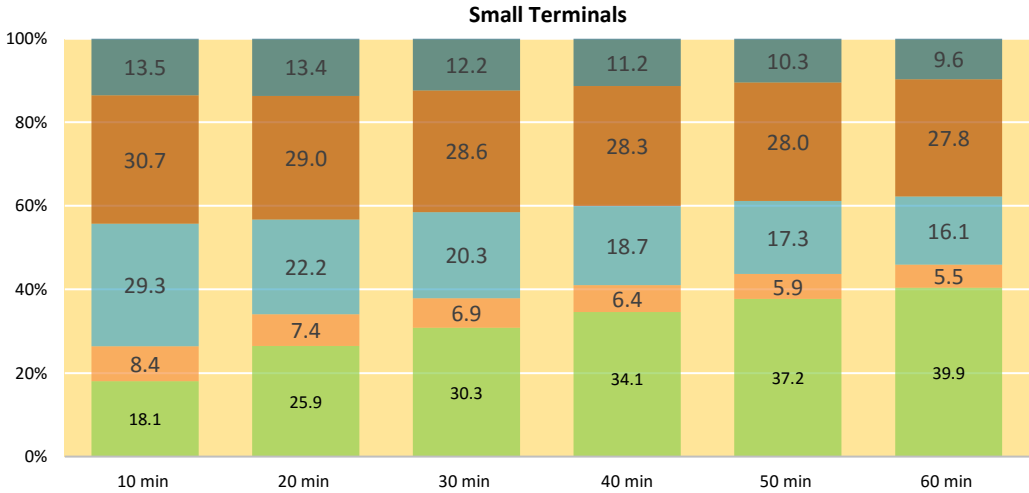

For all terminal sizes, increasing layover time, leads to increasing bus accumulation which leads to increased bus parking area requirement. This results in reduction of percentage of site area under other different functions.

In this scenario, multi level car parking (MLCP) replaces at grade private vehicle parking in medium and large terminals. This is because for these terminal sizes car parking demand exceeds the minimum threshold requirement of 120 for a MLCP.

Terminal building footprint MLCP building footprint MLBP building footprint Circulation and Ped. Plaza Feeder parking area Bus and Workshop area Private Vehicle parking

* The values represented here correspond 60 buses per hour for small terminal, 150 buses per hour for medium terminal and 390 buses per hour for large terminals.

Scenario -3 : With Real Estate development, Multilevel (Ramp) Car and (At grade) Bus parking.

Typology	Inter State	A
Operation	Dynamic Bay	b

Open Area Distribution

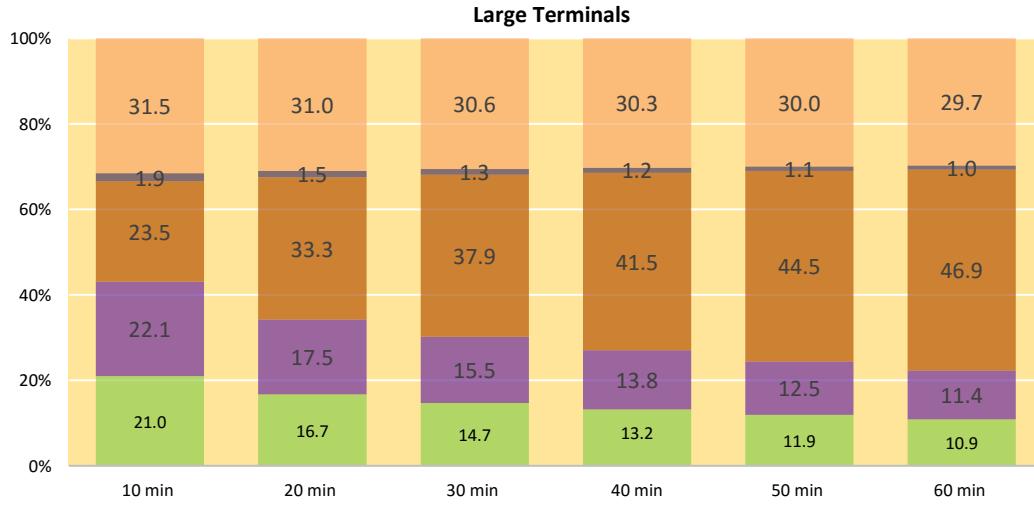
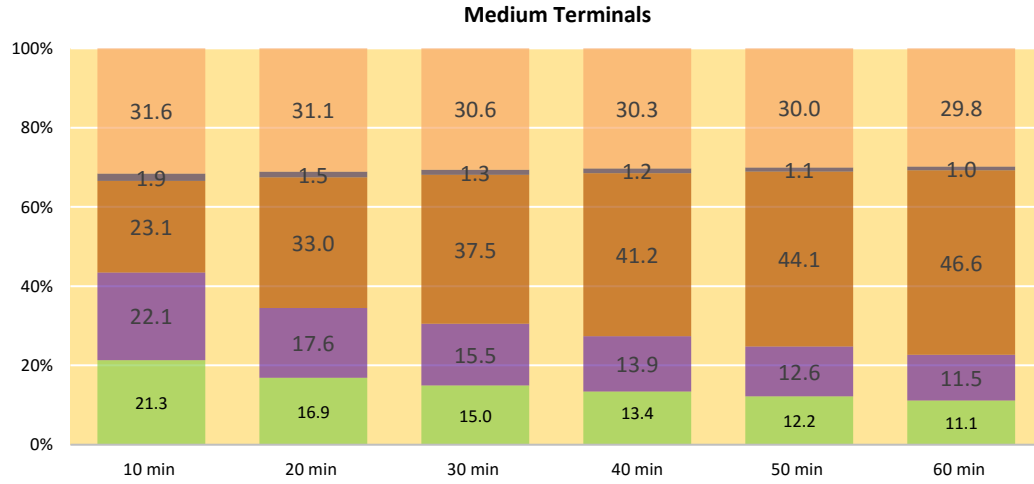
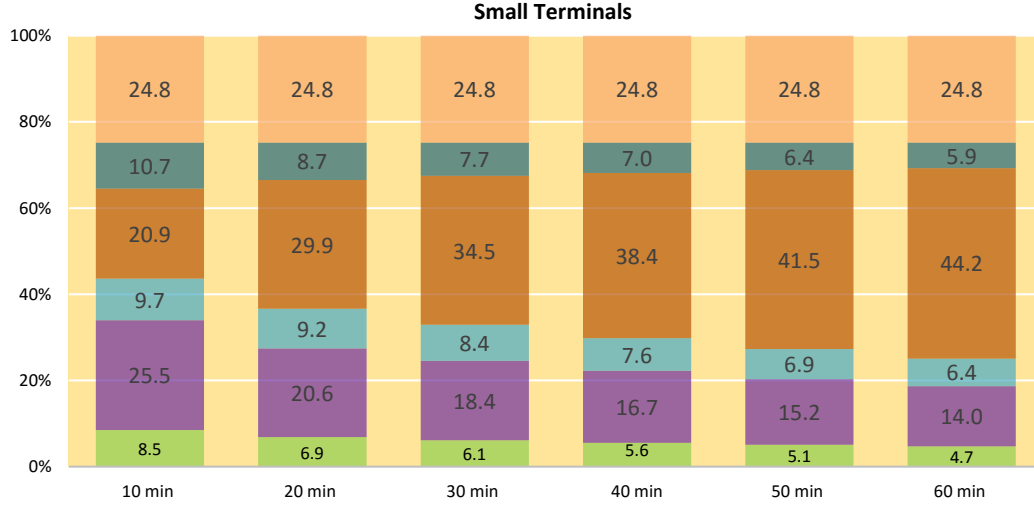

For all terminal sizes, increasing layover time, leads to increasing bus accumulation which leads to increased bus parking area requirement. This results in reduction of percentage of open area under other different functions.

Percentage of open area dedicated to car/Private vehicle parking, for large and medium terminals is '0' as for these terminal sizes (in this scenario) structured car parking is proposed.

Drop Off █ Pick up █ Car Parking █ Bus Parking █ Circulation area █ Workshop area █ Pedestrian plaza █

* The values represented here correspond 60 buses per hour for small terminal, 150 buses per hour for medium terminal and 390 buses per hour for large terminals.

Spatial Requirements

Ab

Scenario -4 : With Real Estate development, Multilevel (Mechanical) Car parking and (At grade) Bus parking.

Typology	Inter State	A
Operation	Dynamic Bay	b

Site Area Distribution

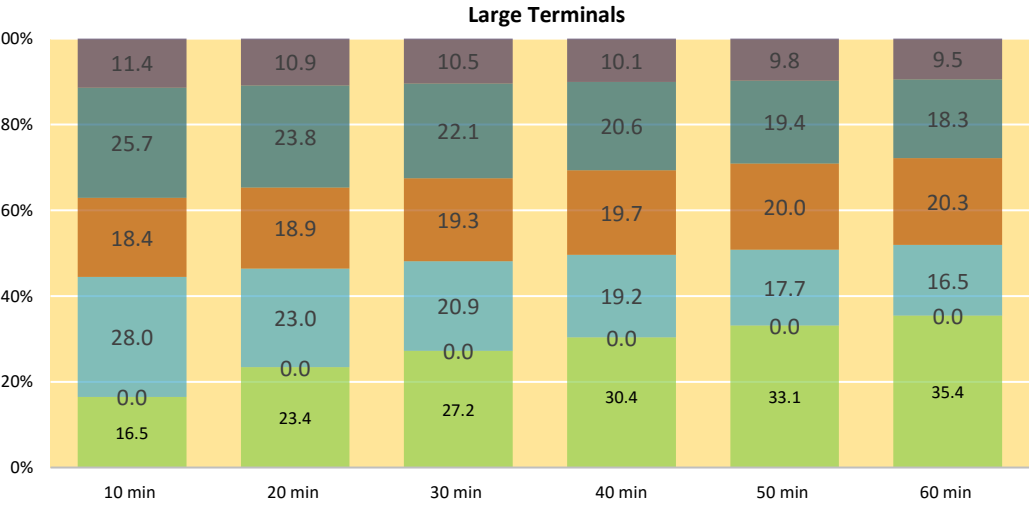
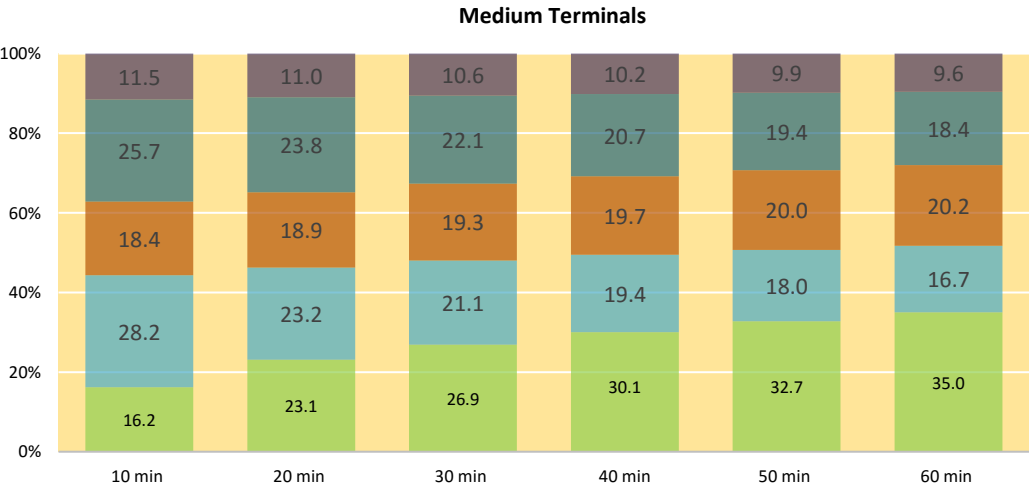
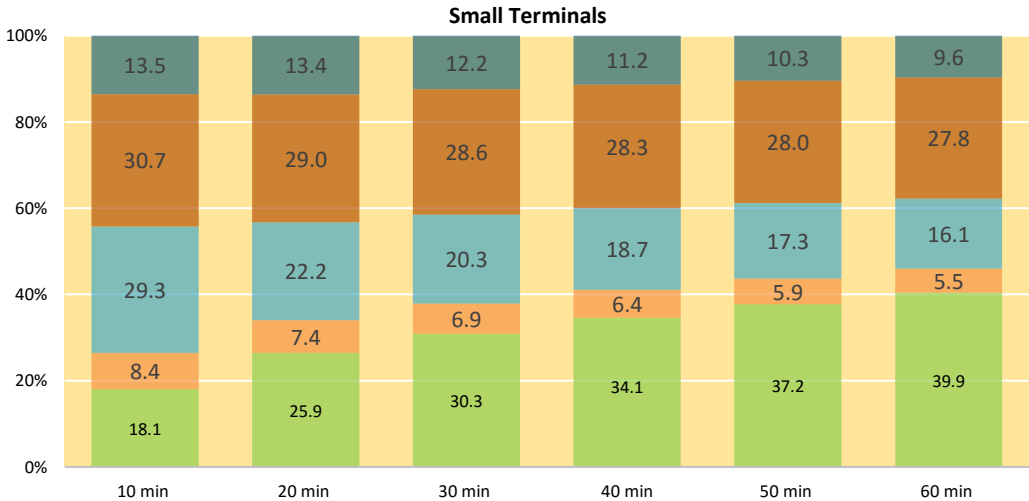

For all terminal sizes, increasing layover time, leads to increasing bus accumulation which leads to increased bus parking area requirement. This results in reduction of percentage of site area under other different functions.

In this scenario, multi level car parking (MLCP) replaces at grade private vehicle parking in medium and large terminals. This is because for these terminal sizes car parking demand exceeds the minimum threshold requirement of 120 for a MLCP.

- Terminal building footprint
- MLCP building footprint
- MLBP building footprint
- Circulation and Ped. Plaza
- Feeder parking area
- Bus and Workshop area
- Private Vehicle parking

* The values represented here correspond 60 buses per hour for small terminal, 150 buses per hour for medium terminal and 390 buses per hour for large terminals.

Scenario -4 : With Real Estate development, Multilevel (Mechanical) Car parking and (At grade) Bus parking.

Typology	Inter State	A
Operation	Dynamic Bay	b

Open Area Distribution

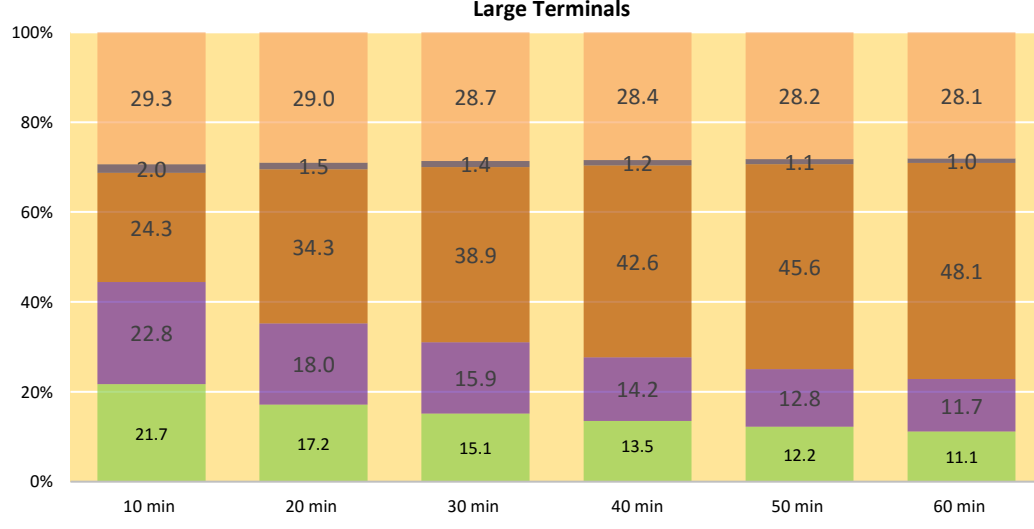
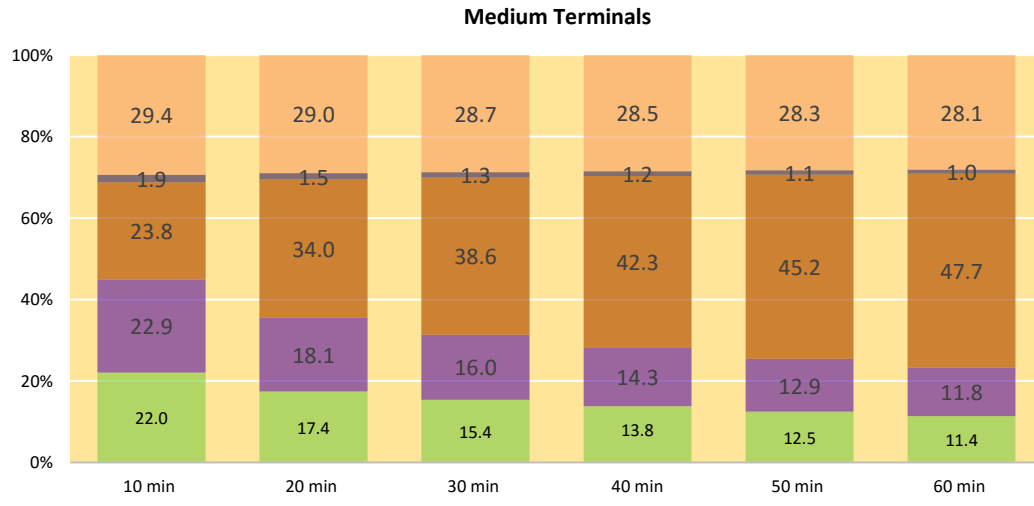
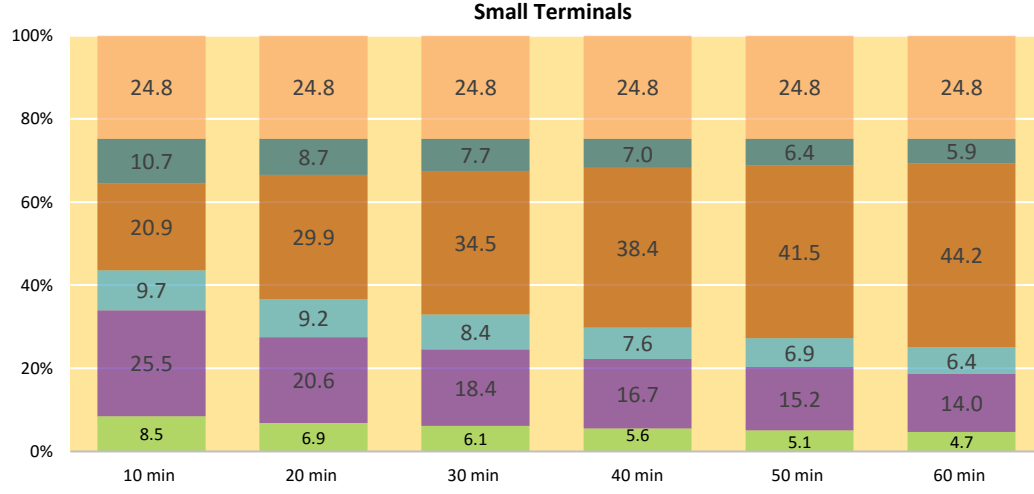

For all terminal sizes, increasing layover time, leads to increasing bus accumulation which leads to increased bus parking area requirement. This results in reduction of percentage of open area under other different functions.

Percentage of open area dedicated to car/Private vehicle parking, for small and medium terminals is '0' as for these terminal sizes (in this scenario) structured car parking is proposed.

Drop Off Pick up Car Parking Bus Parking Circulation area Workshop area Pedestrian plaza

* The values represented here correspond 60 buses per hour for small terminal, 150 buses per hour for medium terminal and 390 buses per hour for large terminals.

Spatial Requirements

Ab

Typology	Inter State	A
Operation	Dynamic Bay	b

Scenario -5 : With Real Estate development, Multilevel (Ramp) Car parking and Multilevel (Ramp) Bus parking

Site Area Distribution

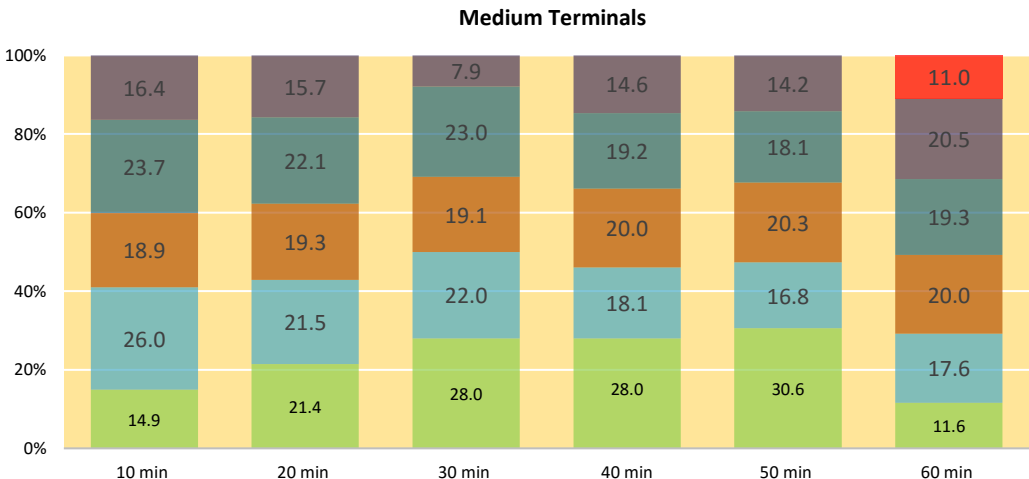
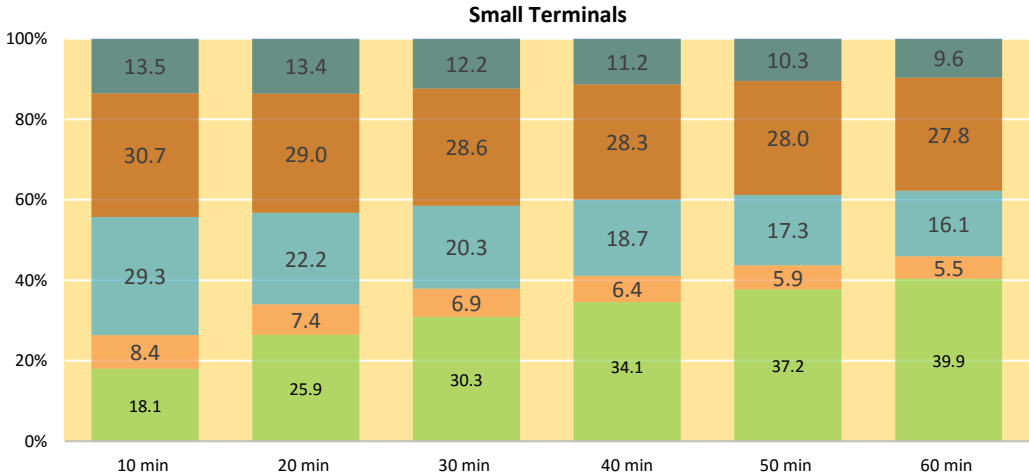

For all terminal sizes, increasing layover time, leads to increasing bus accumulation which leads to increased bus parking area requirement. This results in reduction of percentage of site area under other different functions.

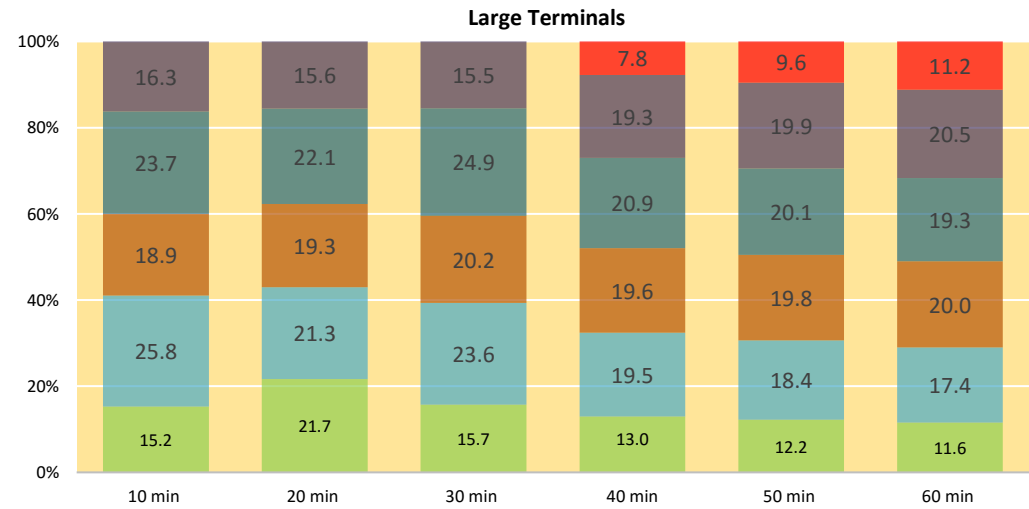

In this scenario, multi level car parking (MLCP) replaces at grade private vehicle parking in medium and large terminals. This is because for these terminal sizes car parking demand exceeds the minimum threshold requirement of 120 for a MLCP.

For layover time 60minutes in medium terminal and layover time 40 to 60 minutes in large terminals, idle bus parking demand exceeds the minimum threshold of 130 buses for a multi level bus parking (MLBP) This leads to introduction of MLBP in these conditions, which results in reduced bus and workshop area.

Terminal building footprint MLCP building footprint MLBP building footprint Circulation and Ped. Plaza Feeder parking area Bus and Workshop area Private Vehicle parking

* The values represented here correspond 60 buses per hour for small terminal, 150 buses per hour for medium terminal and 390 buses per hour for large terminals.

Scenario -5 : With Real Estate development, Multilevel (Ramp) Car parking and Multilevel (Ramp) Bus parking

Typology	Inter State	A
Operation	Dynamic Bay	b

Open Area Distribution

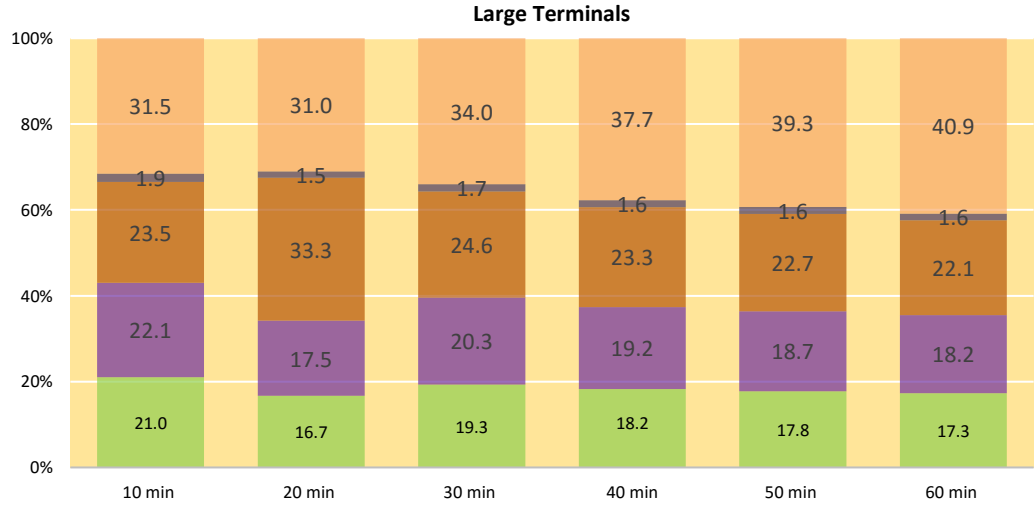
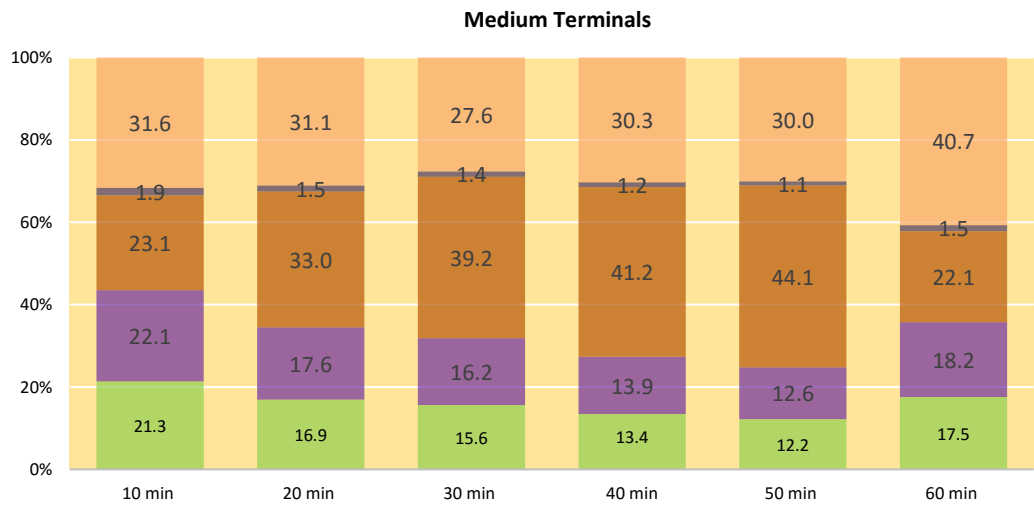
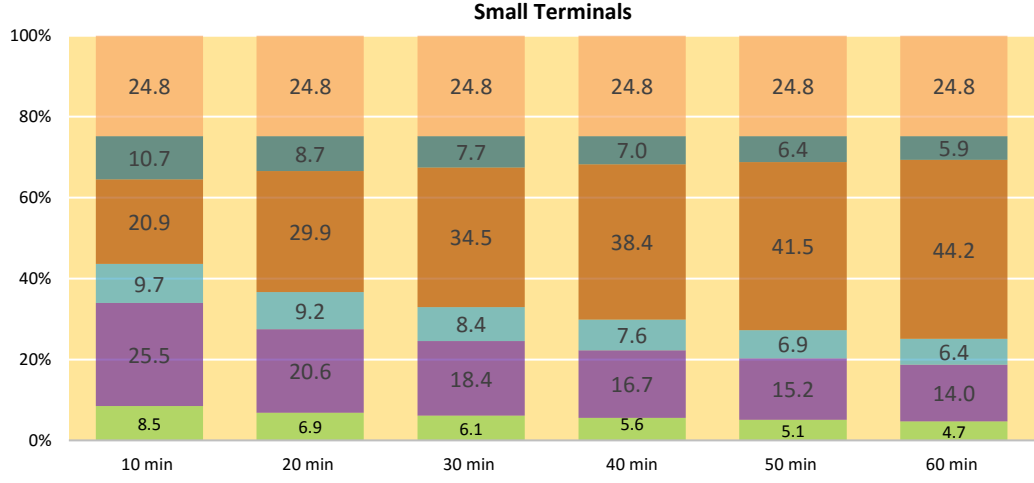

For all terminal sizes, increasing layover time, leads to increasing bus accumulation which leads to increased bus parking area requirement. This results in reduction of percentage of open area under other different functions.

In this scenario, at layover time of 40 minutes for medium terminals and 40 to 60 minutes for large terminals, idle bus parking demand exceeds 130. At this threshold idle bus parking is accommodated in structured parking lot, which eliminates idle parking requirement, leading to a drop in percentage open area under 'bus area' (loading and unloading bays are a part of bus area).

Drop Off Pick up Car Parking Bus Parking Circulation area Workshop area Pedestrian plaza

* The values represented here correspond 60 buses per hour for small terminal, 150 buses per hour for medium terminal and 390 buses per hour for large terminals.

Spatial Requirements

Ab

Typology	Inter State	A
Operation	Dynamic Bay	b

Scenario - 6 : With Real Estate development, Multilevel (Mechanical) Car parking and Multilevel (Ramp) Bus parking

Site Area Distribution

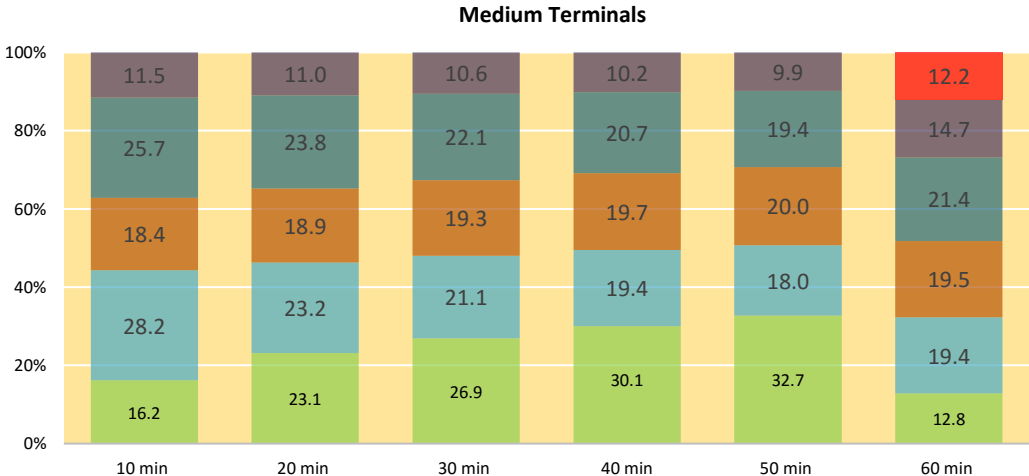
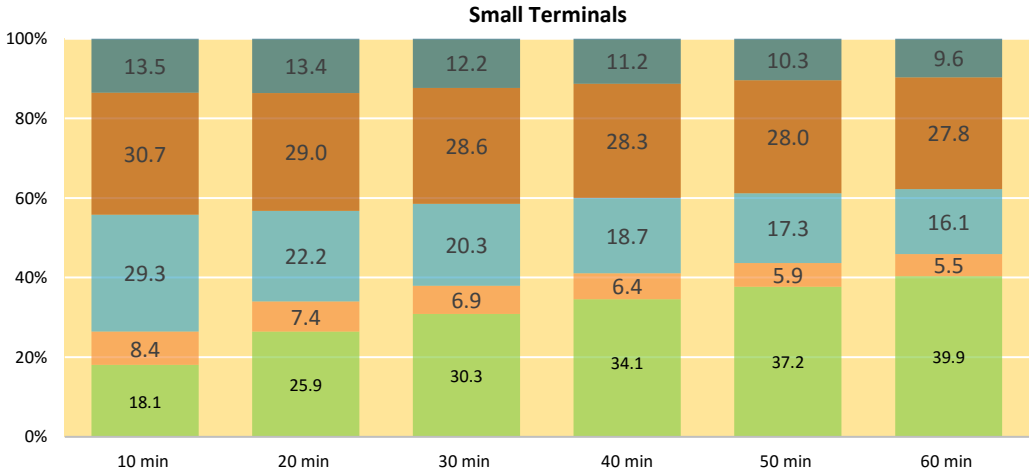

For all terminal sizes, increasing layover time, leads to increasing bus accumulation which leads to increased bus parking area requirement. This results in reduction of percentage of site area under other different functions.

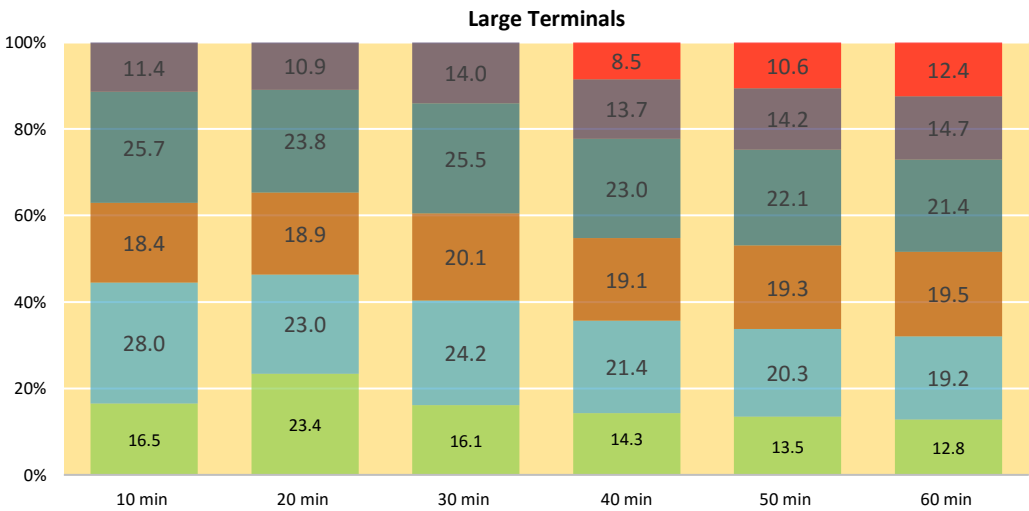

In this scenario, multi level car parking (MLCP) replaces at grade private vehicle parking in medium and large terminals. This is because for these terminal sizes car parking demand exceeds the minimum threshold requirement of 120 for a MLCP.

For layover time 60minutes in medium terminal and layover time 40 to 60 minutes in large terminals, idle bus parking demand exceeds the minimum threshold of 130 buses for a multi level bus parking (MLBP) This leads to introduction of MLBP in these conditions, which results in reduced bus and workshop area.

Terminal building footprint MLCP building footprint MLBP building footprint Circulation and Ped. Plaza Feeder parking area Bus and Workshop area Private Vehicle parking

* The values represented here correspond 60 buses per hour for small terminal, 150 buses per hour for medium terminal and 390 buses per hour for large terminals.

Scenario - 6 : With Real Estate development, Multilevel (Mechanical) Car parking and Multilevel (Ramp) Bus parking

Typology	Inter State	A
Operation	Dynamic Bay	b

Open Area Distribution

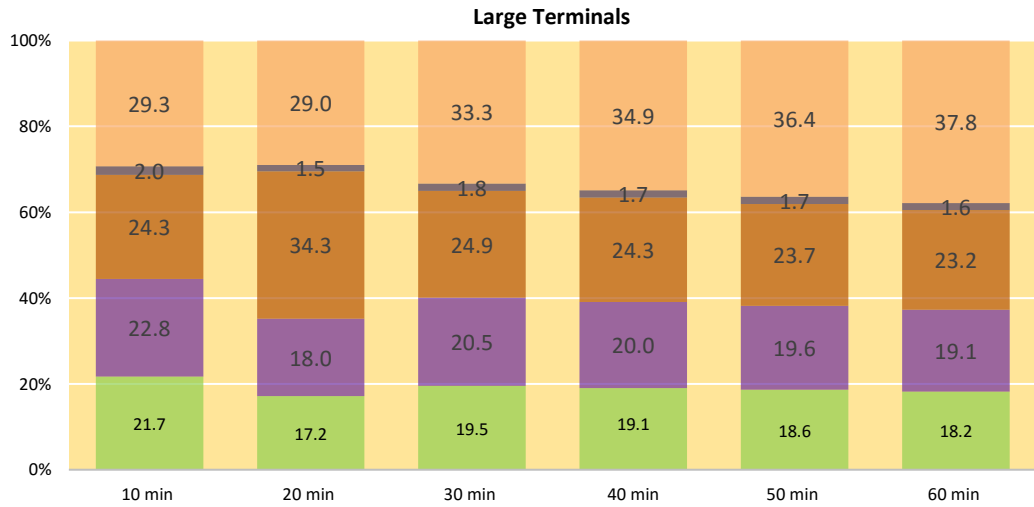
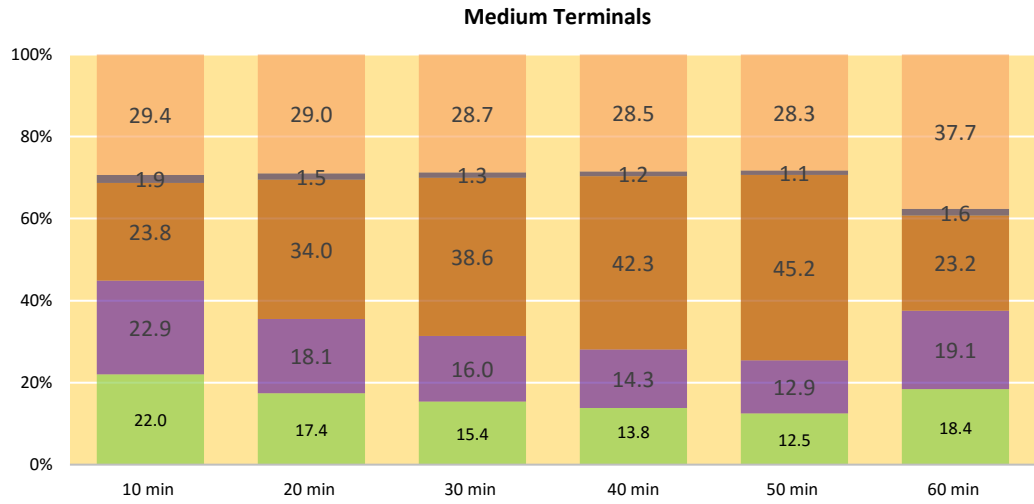
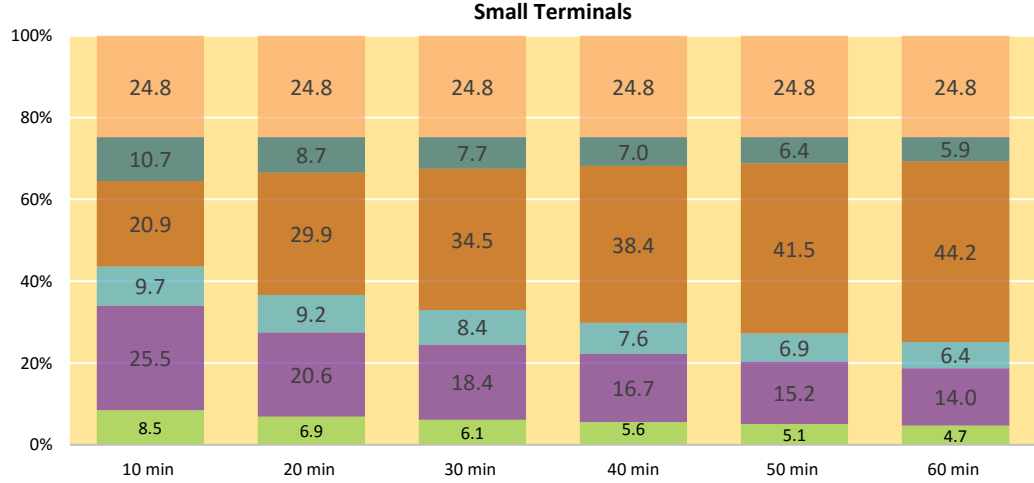

For all terminal sizes, increasing layover time, leads to increasing bus accumulation which leads to increased bus parking area requirement. This results in reduction of percentage of open area under other different functions.

In this scenario, at layover time of 40 minutes for medium terminals and 40 to 60 minutes for large terminals, idle bus parking demand exceeds 130. At this threshold idle bus parking is accommodated in structured parking lot, which eliminates idle parking requirement, leading to a drop in percentage open area under 'bus area' (loading and unloading bays are a part of bus area).

Drop Off ■ Pick up ■ Car Parking ■ Bus Parking ■ Circulation area ■ Workshop area ■ Pedestrian plaza ■

* The values represented here correspond 60 buses per hour for small terminal, 150 buses per hour for medium terminal and 390 buses per hour for large terminals.

Spatial Requirements

Ab

Typology	Inter State	A
Operation	Dynamic Bay	b

Scenario - 7 : With Real estate Development, Basement Car parking & at grade Bus Parking.

Site Area Distribution

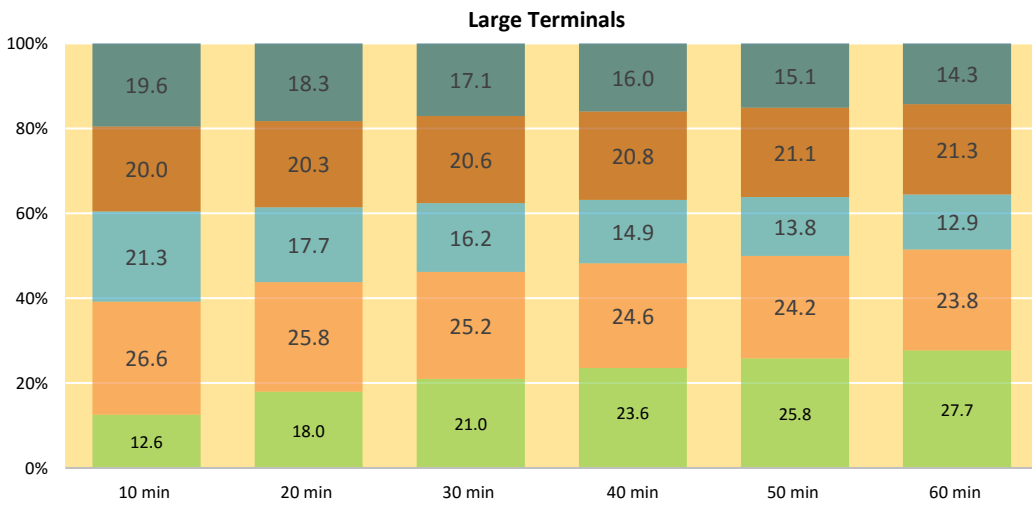
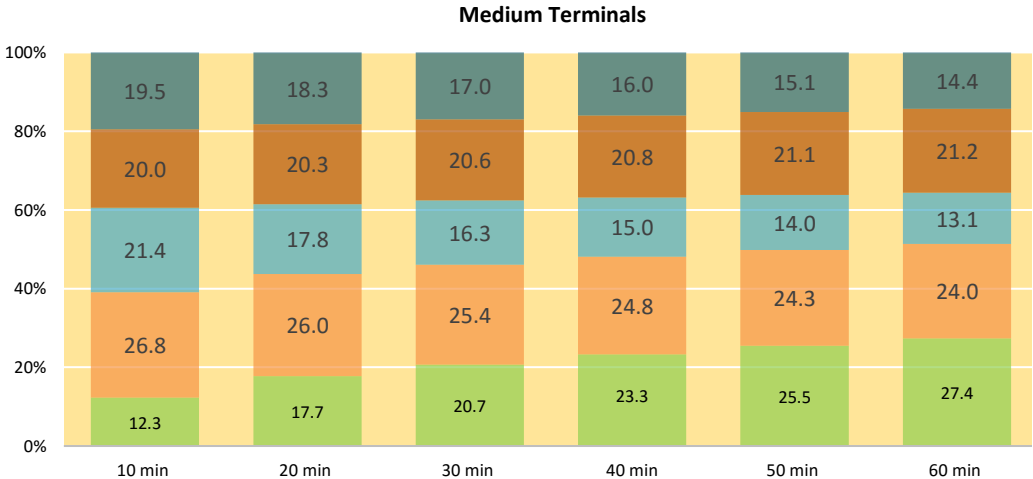
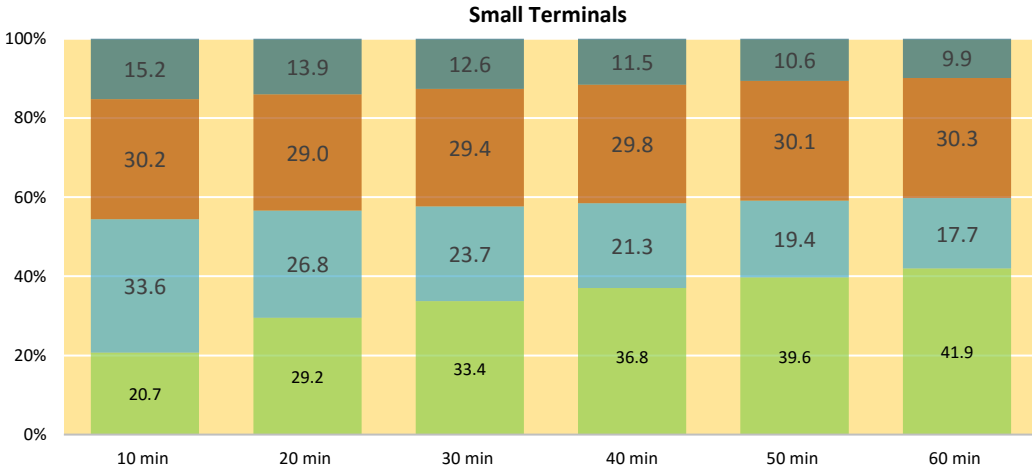

For all terminal sizes, increasing layover time, leads to increasing bus accumulation which leads to increased bus parking area requirement. This results in reduction of percentage of site area under other different functions.

In this scenario, two levels of basement car parking under the terminal building is introduced. This replaces at grade private vehicle parking in small terminals but does not possess enough capacity to accommodate private vehicle parking demand in medium and large terminals with real estate development. This results in significant area being allocated to additional at grade private vehicle parking for these two terminal sizes.

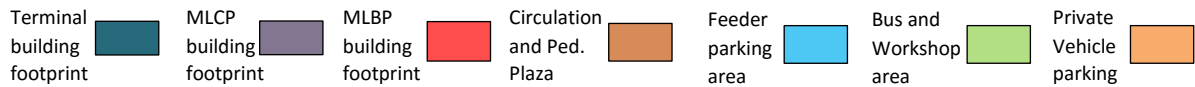

* The values represented here correspond 60 buses per hour for small terminal, 150 buses per hour for medium terminal and 390 buses per hour for large terminals.

Scenario - 7 : With Real estate Development, Basement Car parking & at grade Bus Parking.

Typology	Inter state	A
Operation	Dynamic Bay	b

Open Area Distribution

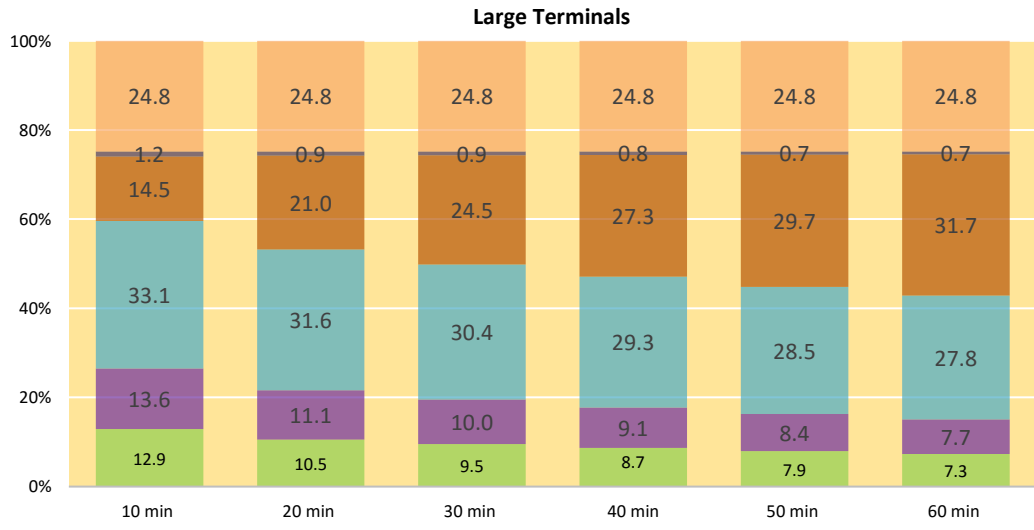
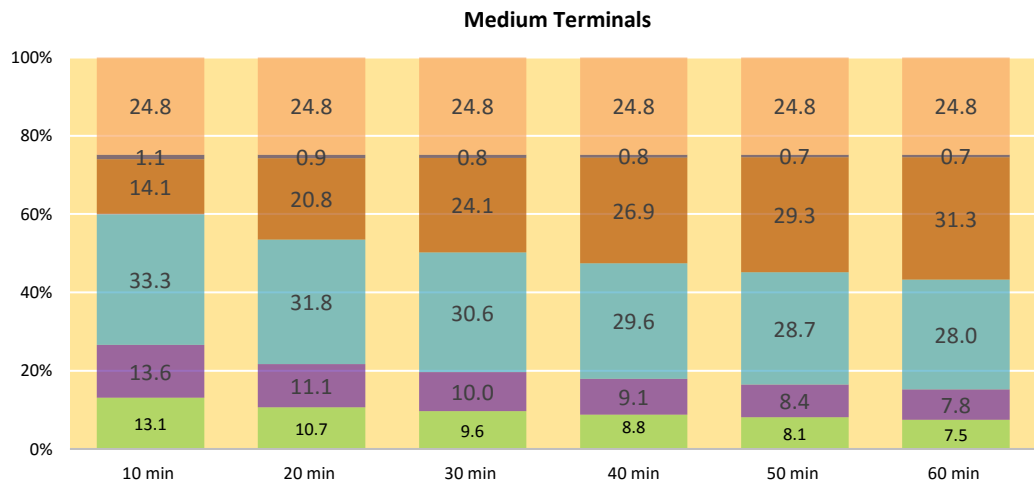
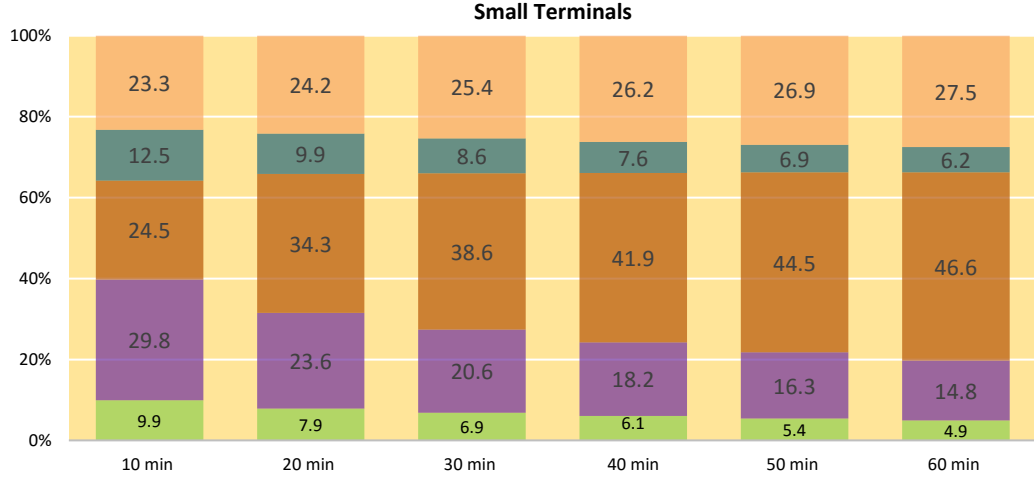

For all terminal sizes, increasing layover time, leads to increasing bus accumulation which leads to increased bus parking area requirement. This results in reduction of percentage of open area under other different functions.
The basement level parking is limited to two floors under the terminal building. This can accommodate only a part of the total parking demand for medium and large terminals. The rest of the vehicles are accommodated in the surface parking.

Drop Off █ Pick up █ Car Parking █ Bus Parking █ Circulation area █ Workshop area █ Pedestrian plaza █

* The values represented here correspond 60 buses per hour for small terminal, 150 buses per hour for medium terminal and 390 buses per hour for large terminals.

Spatial Requirements

Aa

Typology	Inter State	A
Operation	Fixed Route Bay	a

Built up Area Distribution

Small Terminals

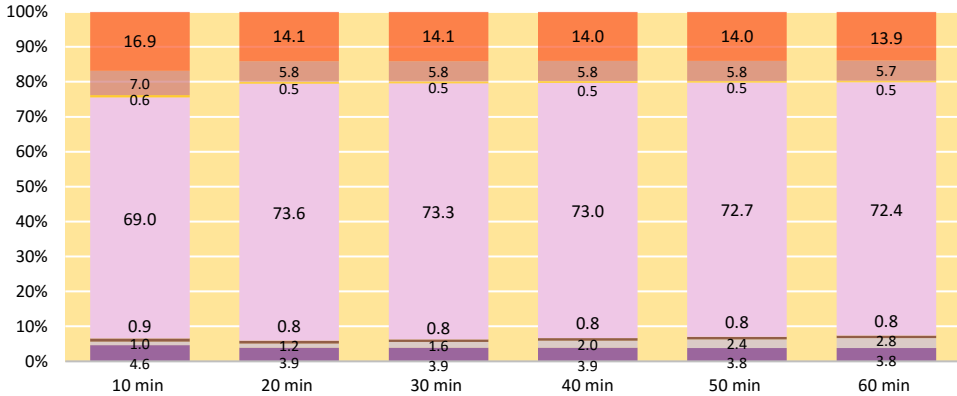

Medium Terminals

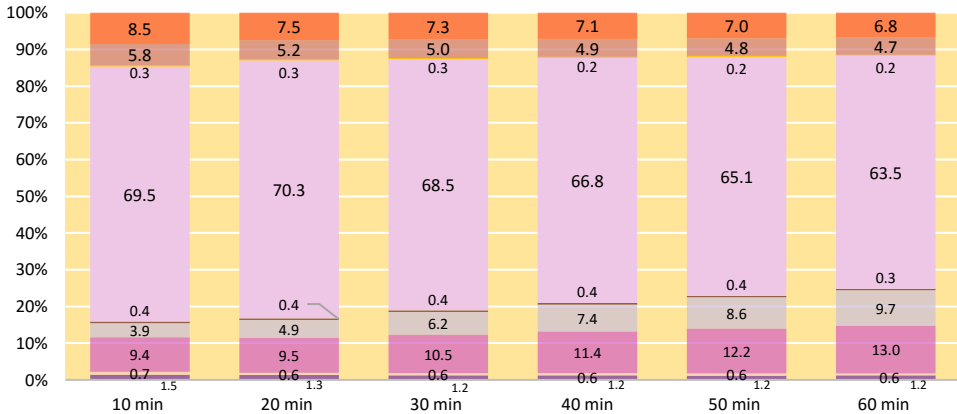

Large Terminals

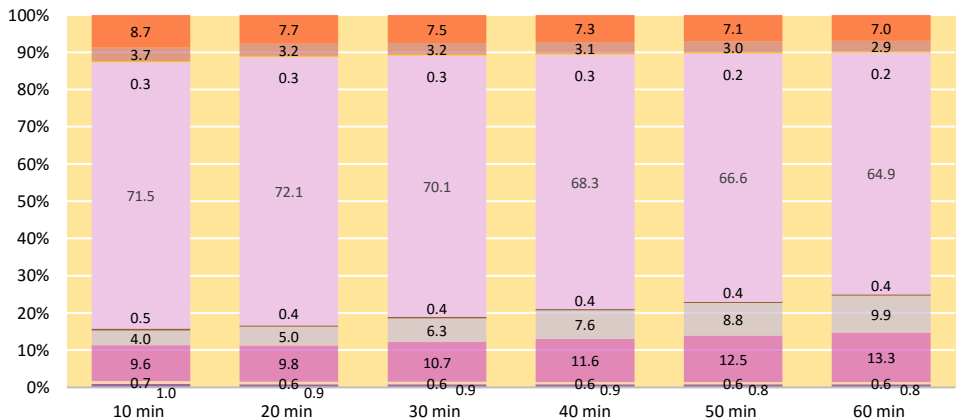

Built area composition remains constant for every scenario and Built up area distribution does not include built up area under commercial/real estate development.

- Passenger Concourse
- Services (Drinking water and Toilets)
- Information
- Canteen and Eateries
- Dormitories and Resting Rooms
- Security
- Terminal Office
- Cloak Room
- Ticket Counter

*The values represented here correspond 60 buses per hour for small terminal, 150 buses per hour for medium terminal and 390 buses per hour for large terminals

Typology	Inter State	A
Operation	Dynamic Bay	b

Built up Area Distribution

Small Terminals

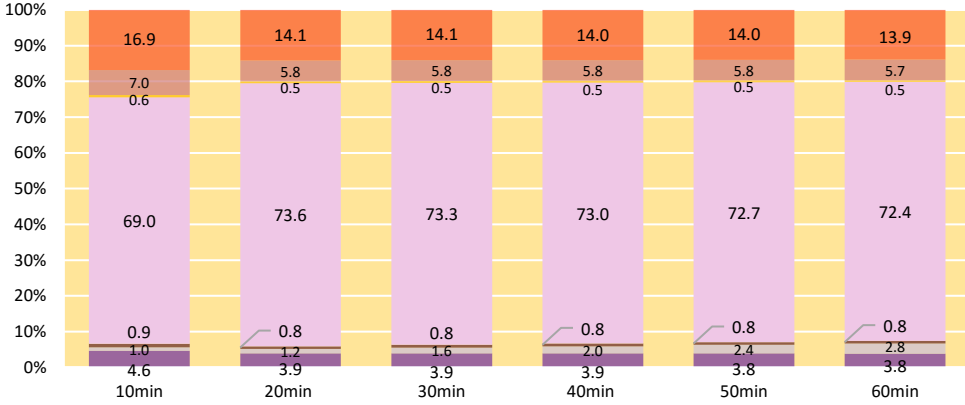

Medium Terminals

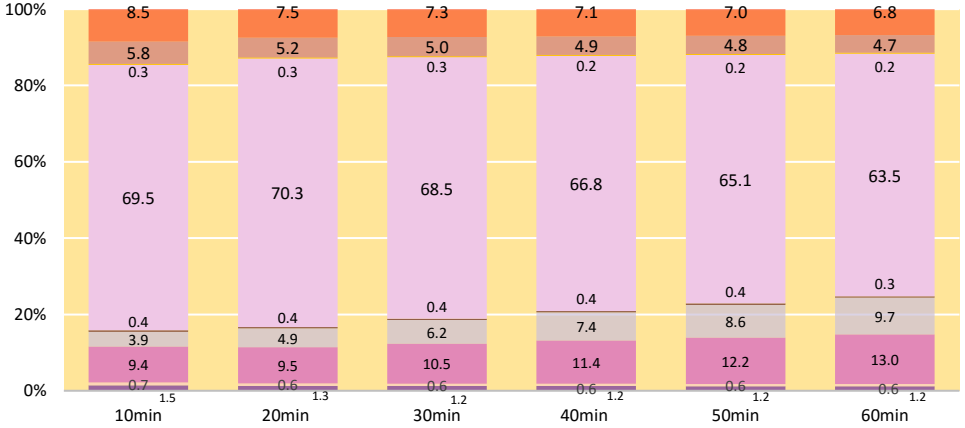

Large Terminals

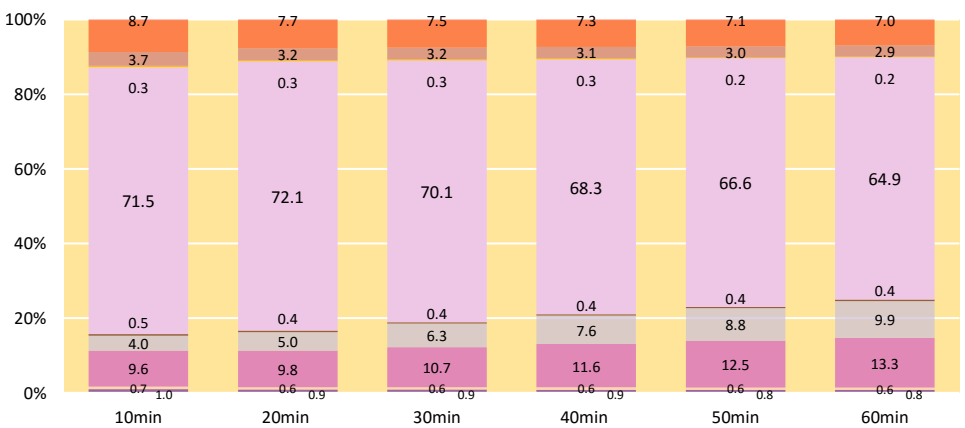

Built area composition remains constant for every scenario and Built up area distribution does not include built up area under commercial/real estate development.

- | | | | | | |
|----------------------|--|---------------------------------------|--|----------------|--|
| Passenger Concourse | | Services (Drinking water and Toilets) | | Information | |
| Canteen and Eateries | | Dormitories and Resting Rooms | | Security | |
| Terminal Office | | Cloak Room | | Ticket Counter | |

*The values represented here correspond 60 buses per hour for small terminal, 150 buses per hour for medium terminal and 390 buses per hour for large terminals

Spatial Requirements

Aa

Typology	Inter State	A
Operation	Fixed Route Bay	a

At grade Bus Parking Area Allocation

Small Terminals

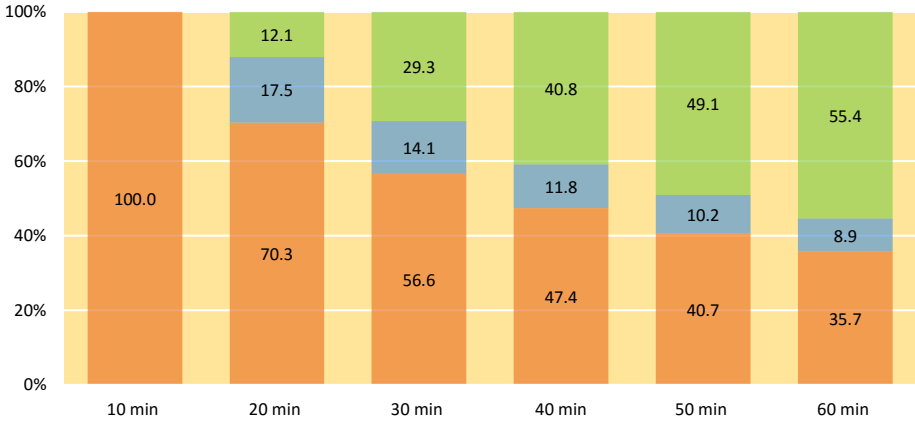

Medium Terminals

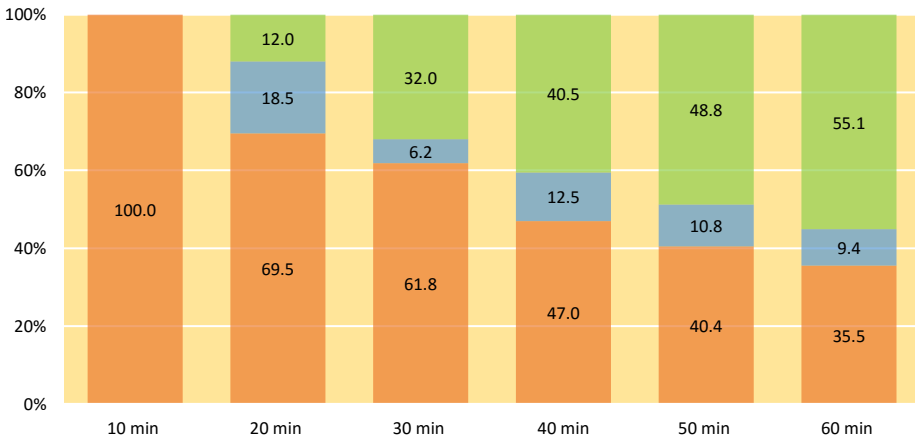

Large Terminals

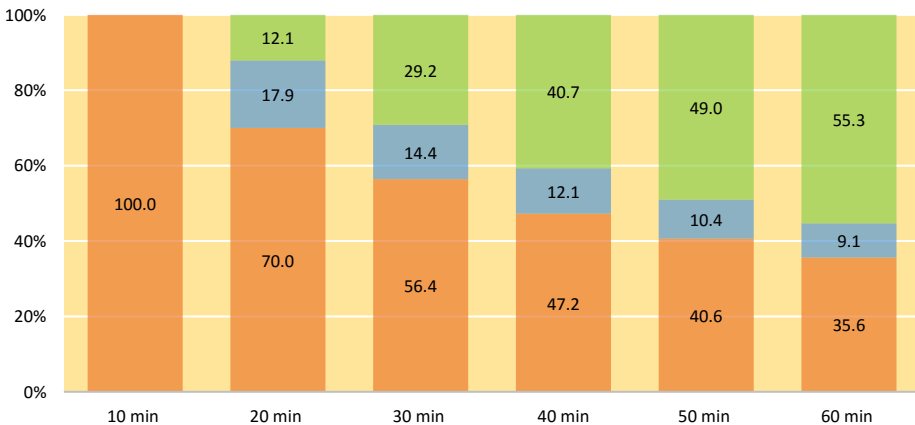

Boarding, alighting and idle parking functions can be worked out with a common bay for layover time upto 10 min. With increasing layover time Idlebus parking requirement increases, across all terminal sizes.

Boarding Bays Off-loading Bays Idle Bus Bays

*The values represented here correspond 60 buses per hour for small terminal, 150 buses per hour for medium terminal and 390 buses per hour for large terminals

Typology	Inter State	A
Operation	Dynamic Bay	b

At grade Bus Parking Allocation

Small Terminals

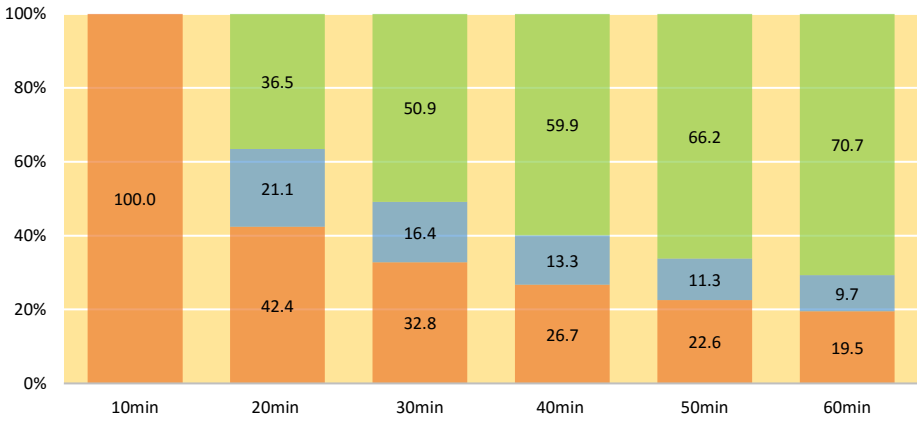

Medium Terminals

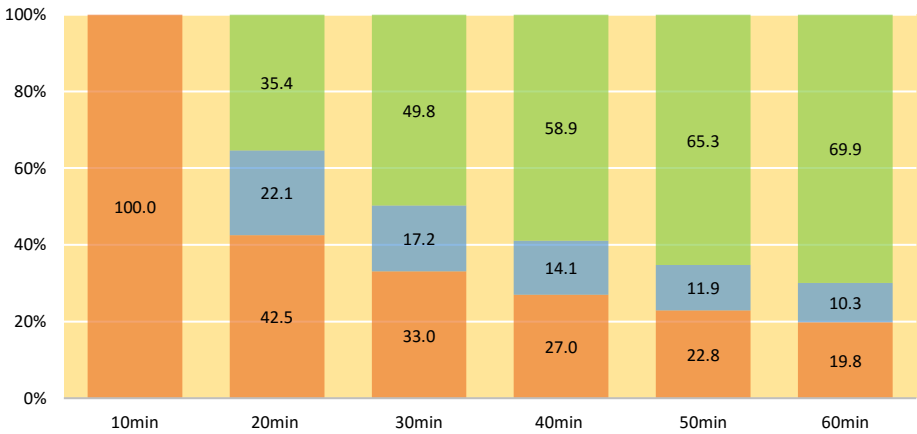

Large Terminals

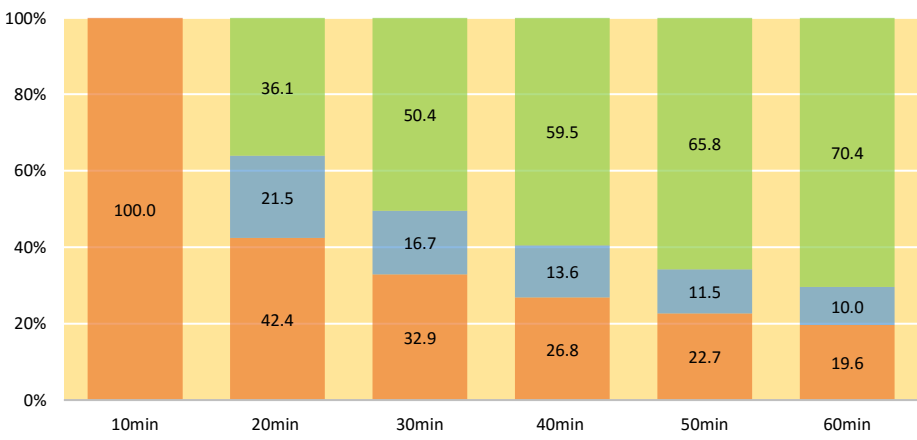

Boarding, alighting and idle parking functions can be worked out with a common bay for layover time upto 10 min. With increasing layover time Idlebus parking requirement increases, across all terminal sizes.

Boarding Bays Off-loading Bays Idle Bus Bays

*The values represented here correspond 60 buses per hour for small terminal, 150 buses per hour for medium terminal and 390 buses per hour for large terminals

Spatial Requirements

Aa

Typology	Inter State	A
Operation	Fixed Route Bay	a

Multilevel Bus Parking Area Allocation

Small Terminals

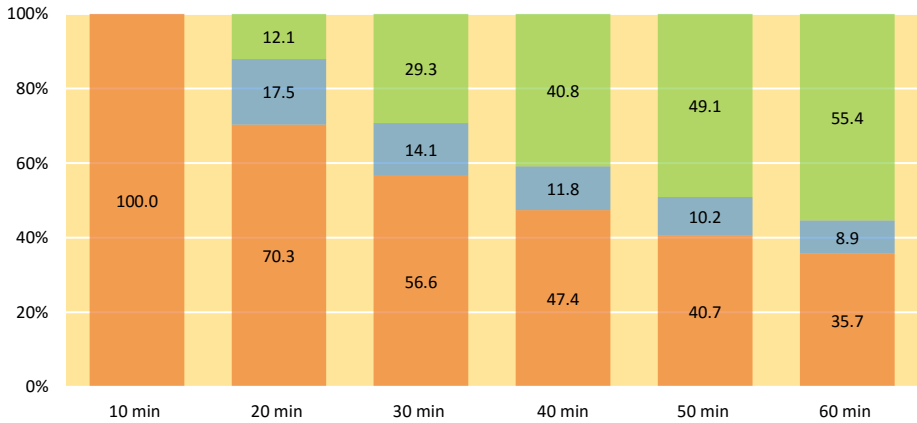

Medium Terminals

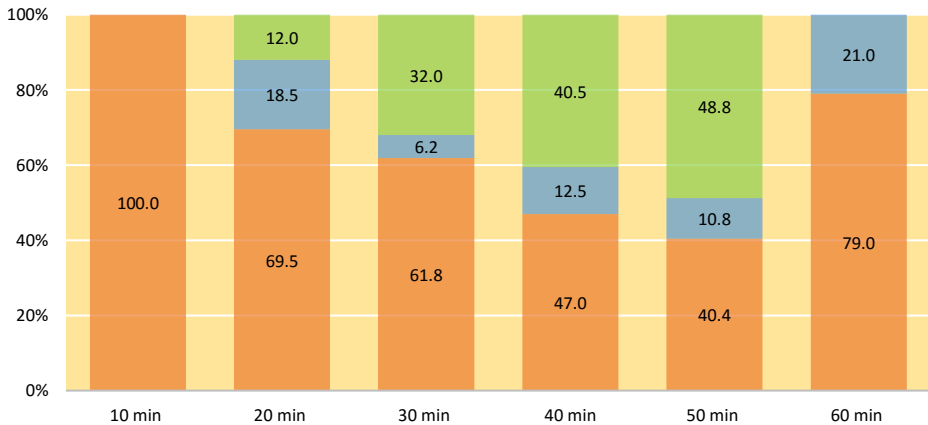

Large Terminals

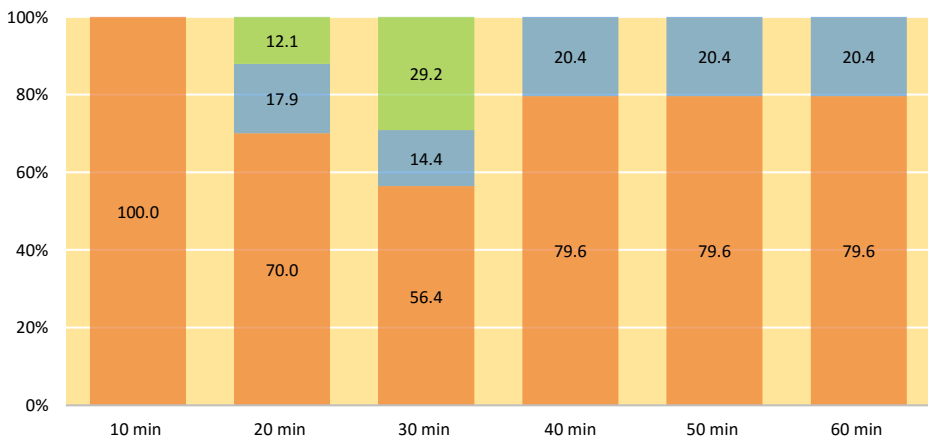

Boarding, alighting and idle parking functions can be worked out with a common bay for layover time upto 10 min across all terminal sizes. Requirement of idle bay drops down at layover time 60 min for medium terminals and from 40 min to 60 min for large terminal as multilevel parking is introduced.

Boarding Bays Off-loading Bays Idle Bus Bays

*The values represented here correspond 60 buses per hour for small terminal, 150 buses per hour for medium terminal and 390 buses per hour for large terminals

Typology	Inter State	A
Operation	Dynamic Bay	b

Multilevel Bus Parking Allocation

Small Terminals

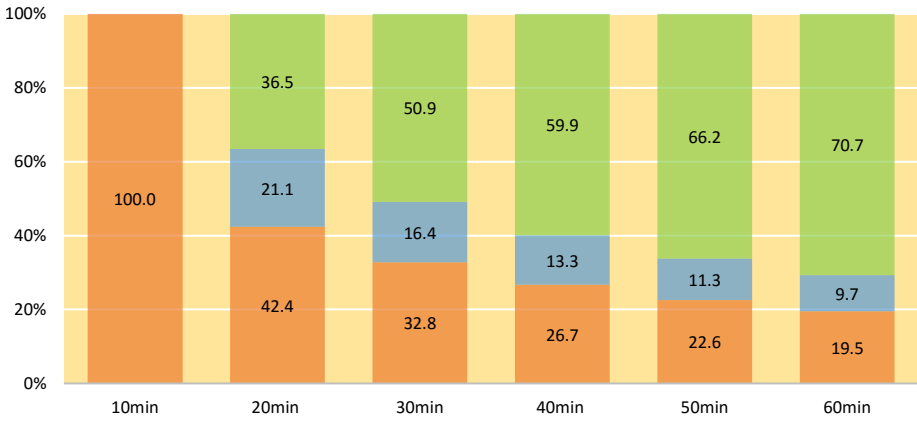

Medium Terminals

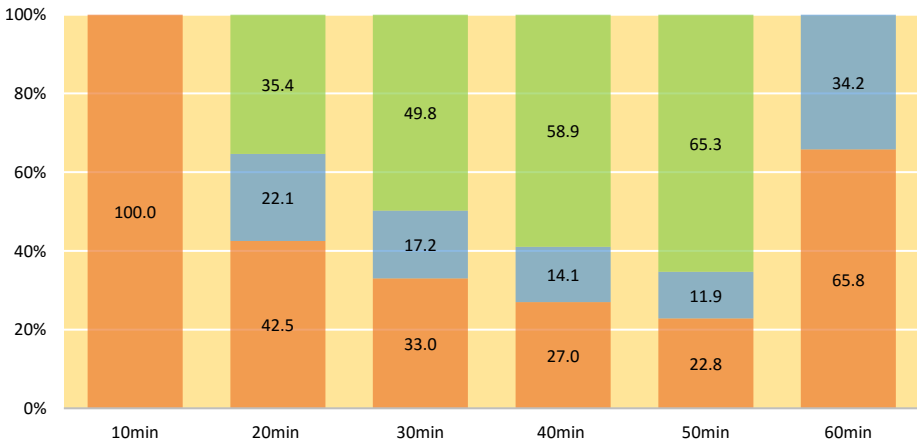

Large Terminals

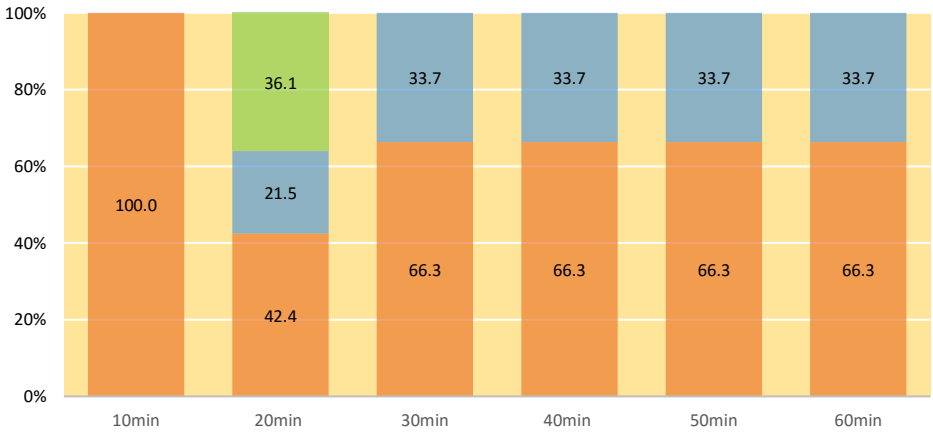

Boarding, alighting and idle parking functions can be worked out with a common bay for layover time upto 10 min across all terminal sizes. Requirement of idle bay drops down at layover time 60 min for medium terminals and from 30 min to 60 min for large terminal as multilevel parking is introduced.

Boarding Bays (orange), Off-loading Bays (blue), Idle Bus Bays (green)

*The values represented here correspond 60 buses per hour for small terminal, 150 buses per hour for medium terminal and 390 buses per hour for large terminals

Spatial Requirements

Ba

Typology	Local	B
Operation	Fixed Route Bay	a

Site Area Requirement

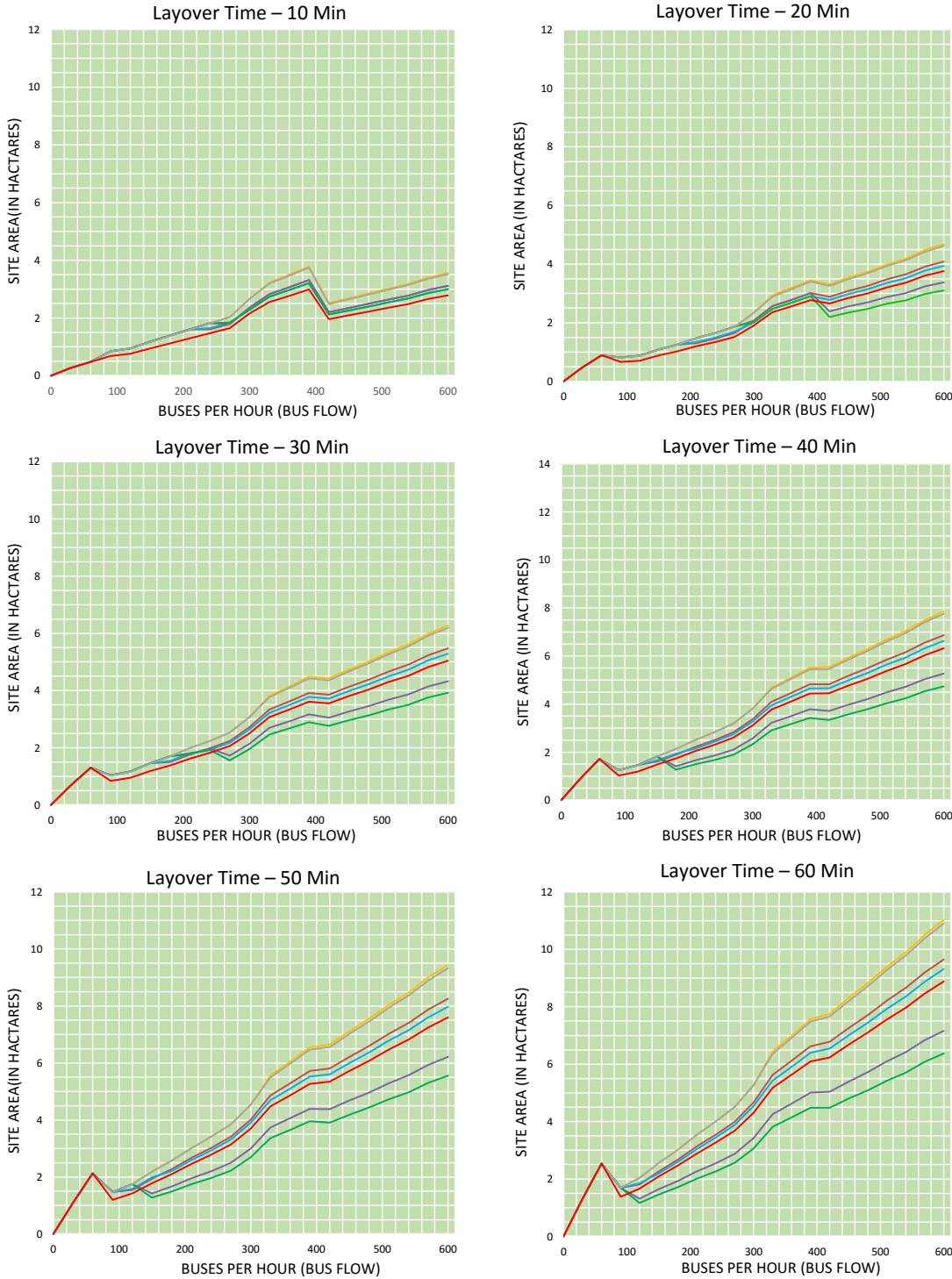

A sudden drop in site area requirement is observed at 60 buses per hour for layover times 20 to 60 minutes. This is caused by segregation of bus parking (from all boarding bays) in to offloading, and space efficient idle bays. Circulation of buses through idle bays becomes feasible for longer layover times.

A sudden jump in site area requirement is observed at 270 buses per hour for all layover times. This is caused by introduction of additional staff and passenger amenities (such as restroom and canteens) for medium size (bus flow greater than or equal to 300 buses per hour) bus terminals.

A drop (or reduction in slope) in terminal area requirement is observed at 390 buses per hour in all layover time. This caused by introduction of more space efficient (but less time efficient) angular boarding bays (instead of drive through or saw tooth bays) for terminals catering to more than 400 buses per hour.

The steep drop in site area requirement for scenario 5 and 6, for layover times 20 min., 30min, 40min, 50min, and 60min after 390 buses/hour, 240 buses/hour, 150 buses/hour, 120 buses/hour and 90 buses/hour respectively; is caused by introduction of multi-level bus parking (MLBP). The MLBP becomes feasible when the idle parking demand crosses the minimum threshold of 130.

- | | | | |
|---|--|--|--|
| 1. Without Real estate Development, at grade Parking (Car & Bus) | | 5. With Real Estate development, Multilevel (Ramp) Car and Multilevel (Ramp) Bus parking | |
| 2. With Real estate Development, at grade Parking (Car & Bus) | | 6. With Real Estate development, Multilevel (Mechanical) Car and Multilevel (Ramp) Bus parking | |
| 3. With Real Estate development, Multilevel (Ramp) Car and (At grade) Bus parking | | 7. With Real estate Development, Basement Parking Car parking & at grade Bus Parking | |
| 4. With Real Estate development, Multilevel (Mechanical) Car and (At grade) Bus parking | | | |

Typology	Local	B
Operation	Dynamic Bay	b

Site Area Requirement

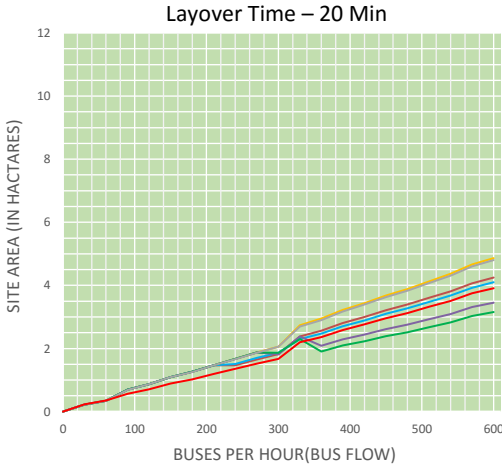
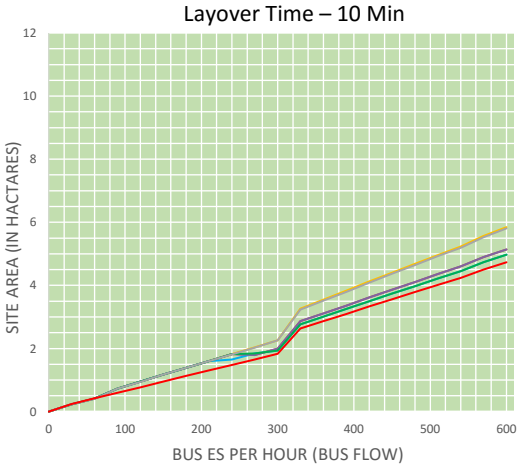

A slight drop in site area requirement is observed at 60 buses per hour for layover times 20 to 60 minutes. This is caused by segregation of bus parking (from all boarding bays) in to offloading, and space efficient idle bays. Circulation of buses through idle bays becomes feasible for longer layover times.

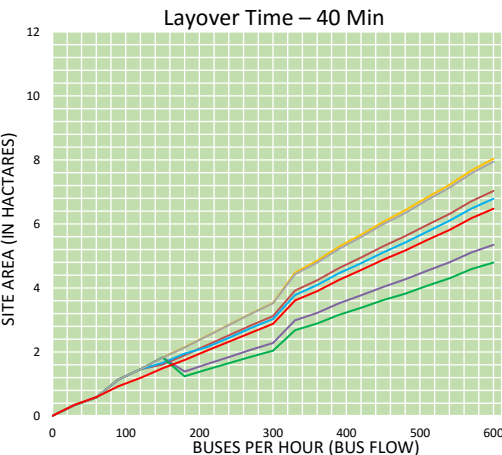
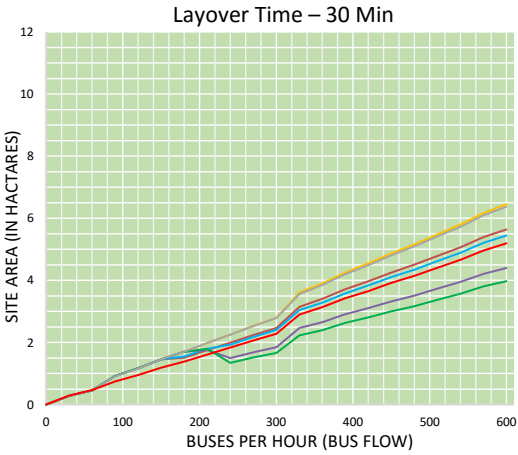

A sudden jump in site area requirement is observed at 300 buses per hour for all layover times. This is caused by introduction of additional staff and passenger amenities (such as restroom and canteens) for medium size (bus flow greater than or equal to 300 buses per hour) bus terminals.

A slight drop (or reduction in slope) in terminal area requirement is observed at 390 buses per hour in all scenarios for all layover time. This caused by introduction of more space efficient (but less time efficient) angular boarding bays (instead of drive through or saw tooth bays) for terminals catering to more than 400 buses per hour.

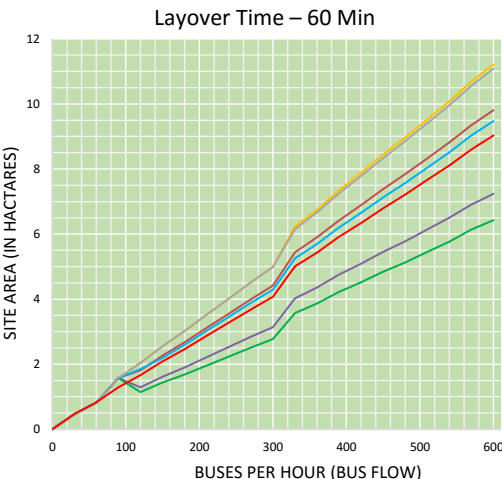
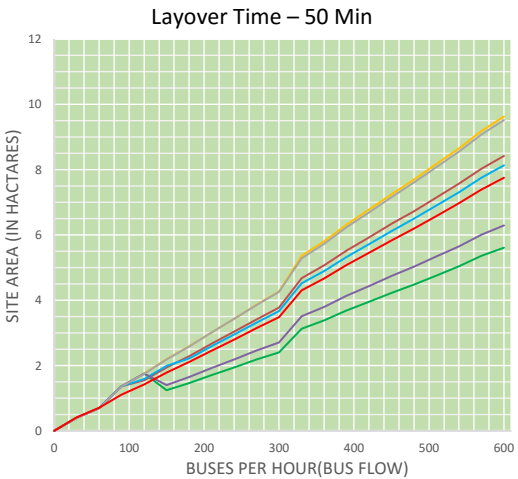

The steep drop in site area requirement for scenario 5 and 6, for layover times 20 min., 30min, 40min, 50min, and 60min after 390 buses/hour, 240 buses/hour, 150 buses/hour, 120 buses/hour and 90 buses/hour respectively; is caused by introduction of multi-level bus parking (MLBP). The MLBP becomes feasible when the idle parking demand crosses the minimum threshold of 130

- | | | | |
|---|--|--|--|
| 1. Without Real estate Development, at grade Parking (Car & Bus) | | 5. With Real Estate development, Multilevel (Ramp) Car and Multilevel (Ramp) Bus parking | |
| 2. With Real estate Development, at grade Parking (Car & Bus) | | 6. With Real Estate development, Multilevel (Mechanical) Car and Multilevel (Ramp) Bus parking | |
| 3. With Real Estate development, Multilevel (Ramp) Car and (At grade) Bus parking | | 7. With Real Estate Development, Basement Parking Car parking & at grade Bus Parking | |
| 4. With Real Estate development, Multilevel (Mechanical) Car and (At grade) Bus parking | | | |

Spatial Requirements

Ba

Typology	Local	B
Operation	Fixed Route Bay	a

Car parking Requirement

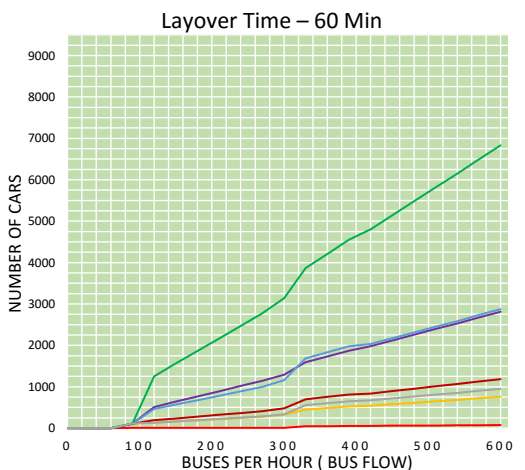
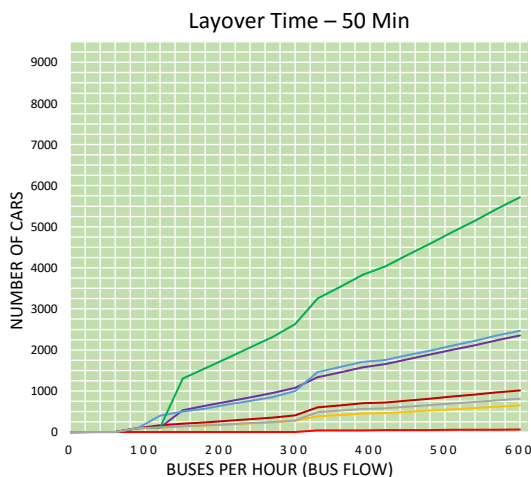
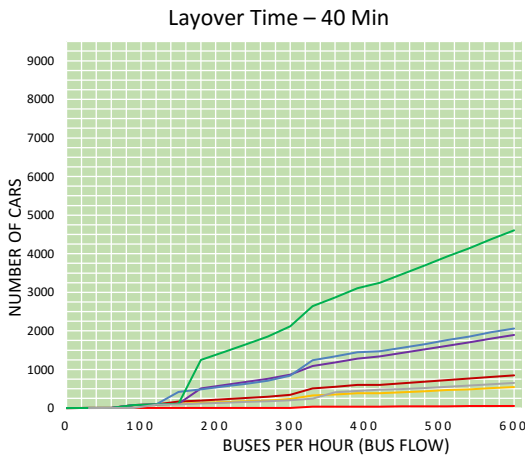
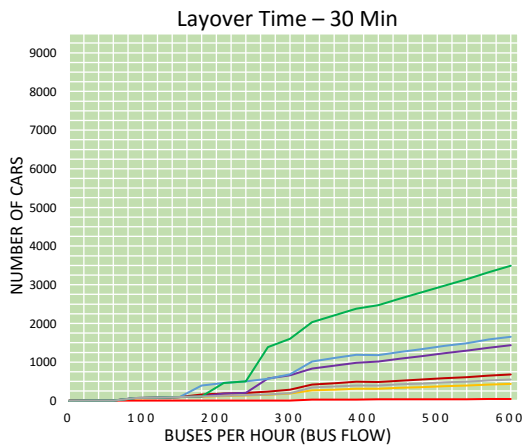
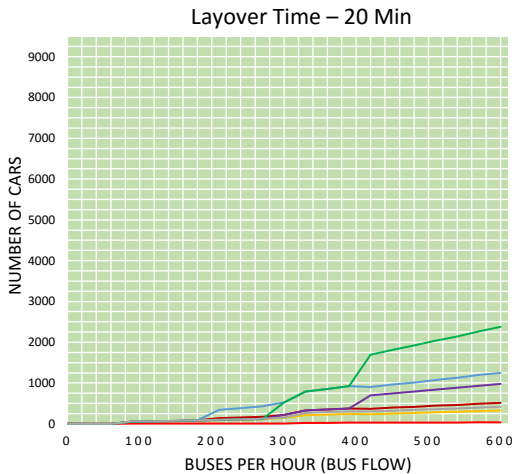
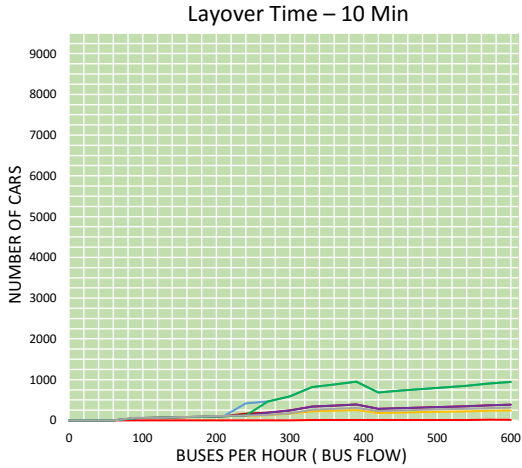

A slight jump in parking demand for scenarios 2 to 7 for all layover time is attributed to introduction of parking demand associated with real estate/commercial development (to offset the cost of terminal development) which is recommended for these scenarios for terminals catering to more than 90 buses per hour.

For scenarios 3 to 6, surge in parking demand at 300 to 90 buses per hour in all layover times is a result of surge in commercial/real estate area requirement. This surge is caused by increased cost of terminal development because of introduction of structured parking when the car parking demand exceeds the minimum threshold of 120.

Slight decline in parking demand in all scenarios for all layover time, at more than 390 buses per hour is attributed to decline in commercial/real estate development required to offset terminal development cost. This declines as the site area required to be developed reduces because of introduction of more space efficient parking arrangement for buses. Similar reason is attributed to surge in parking demand for scenario 5 and 6, 390 to 90 buses per hour in layover time 20 to 60 minutes. Commercial requirement increases to offset additional cost of multi level bus parking development when idle parking demand exceeds 130.

- | | | | |
|---|---|--|---|
| 1. Without Real estate Development, at grade Parking (Car & Bus) | — | 5. With Real Estate development, Multilevel (Ramp) Car and | — |
| 2. With Real estate Development, at grade Parking (Car & Bus) | — | Multilevel (Ramp) Bus parking | — |
| 3. With Real Estate development, Multilevel (Ramp) Car and (At grade) | — | 6. With Real Estate development, Multilevel (Mechanical) Car | — |
| Bus parking | — | and Multilevel (Ramp) Bus parking | — |
| 4. With Real Estate development, Multilevel (Mechanical) Car and (At | — | 7. With Real estate Development, Basement Parking Car park- | — |
| grade) Bus parking | — | ing & at grade Bus Parking | — |

Typology	Local	B
Operation	Dynamic Bay	b

Car parking Requirement

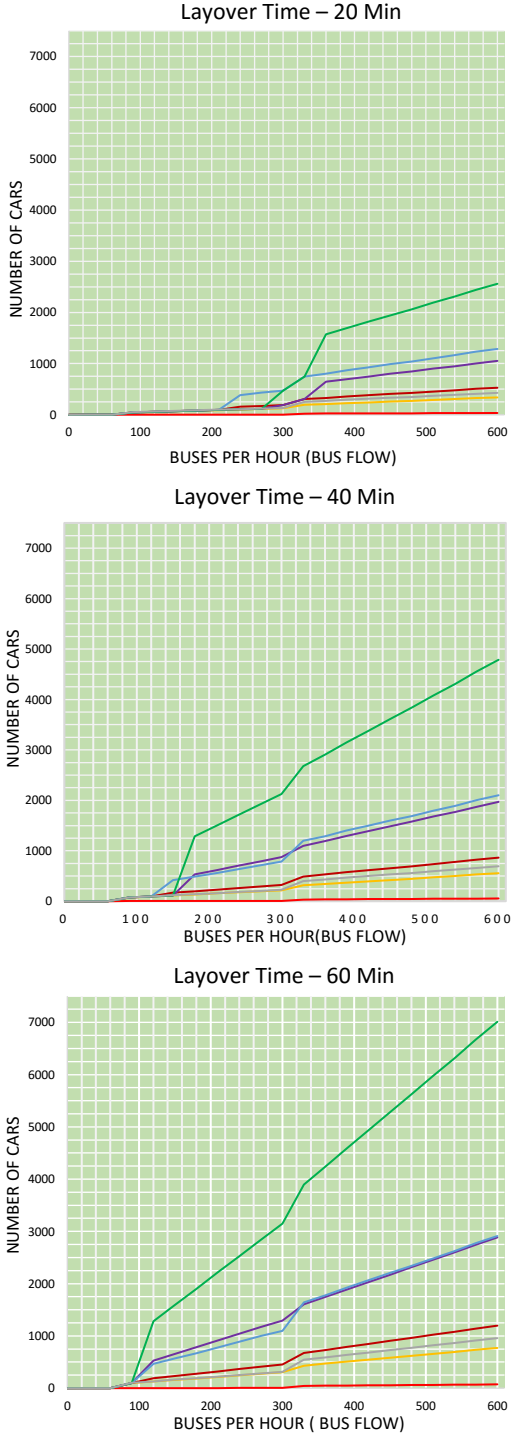
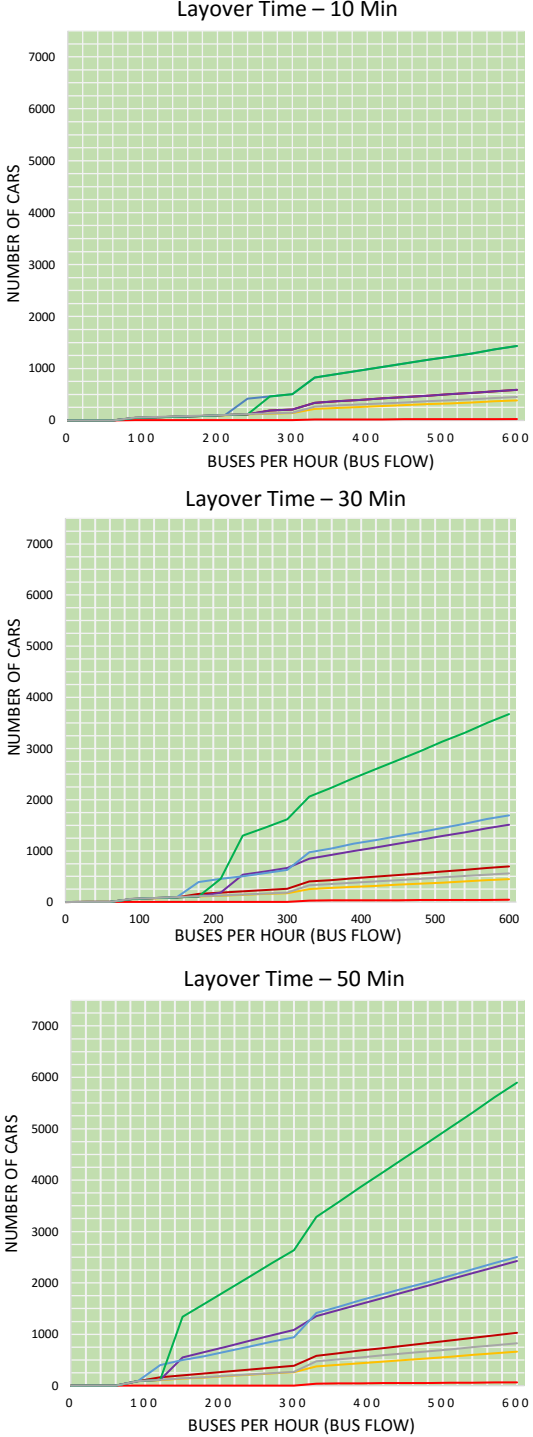

A slight jump in parking demand for scenarios 2 to 7 for all layover time is attributed to introduction of parking demand associated with real estate/commercial development (to offset the cost of terminal development) which is recommended for these scenarios for terminals catering to more than 60 buses per hour.

For scenarios 3 to 6, surge in parking demand at 300 to 90 buses per hour in all layover times is a result of surge in commercial/real estate area requirement. This surge is caused by increased cost of terminal development because of introduction of structured parking when the car parking demand exceeds the minimum threshold of 120.

Slight decline in parking demand in all scenarios for all layover time, at more than 390 buses per hour is attributed to decline in commercial/real estate development required to offset terminal development cost. This declines as the site area required to be developed reduces because of introduction of more space efficient parking arrangement for buses. Similar reason is attributed to surge in parking demand for scenario 5 and 6, 390 to 90 buses per hour in layover time 20 to 60 minutes. Commercial requirement increases to offset additional cost of multi level bus parking development when idle parking demand exceeds 130.

- | | | | |
|---|---------------------------------------|--|---------------------------------------|
| 1. Without Real estate Development, at grade Parking (Car & Bus) | — | 5. With Real Estate development, Multilevel (Ramp) Car and Multilevel (Ramp) Bus parking | — |
| 2. With Real estate Development, at grade Parking (Car & Bus) | — | 6. With Real Estate development, Multilevel (Mechanical) Car and Multilevel (Ramp) Bus parking | — |
| 3. With Real Estate development, Multilevel (Ramp) Car and (At grade) Bus parking | — | 7. With Real estate Development, Basement Parking Car parking & at grade Bus Parking | — |
| 4. With Real Estate development, Multilevel (Mechanical) Car and (At grade) Bus parking | — | | |

Spatial Requirements

Ba

Typology	Local	A
Operation	Fixed Route Bay	a

Bus Bay Numbers

Boarding Bay Numbers

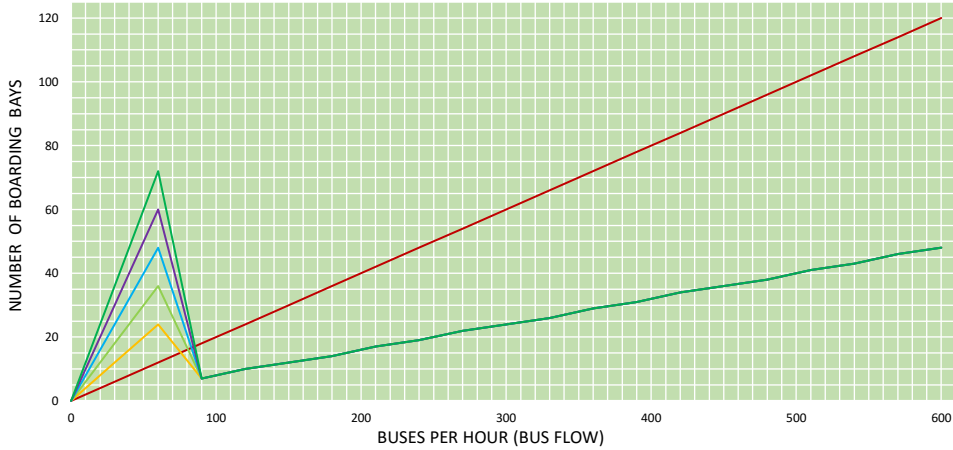

Off-loading Bay Numbers

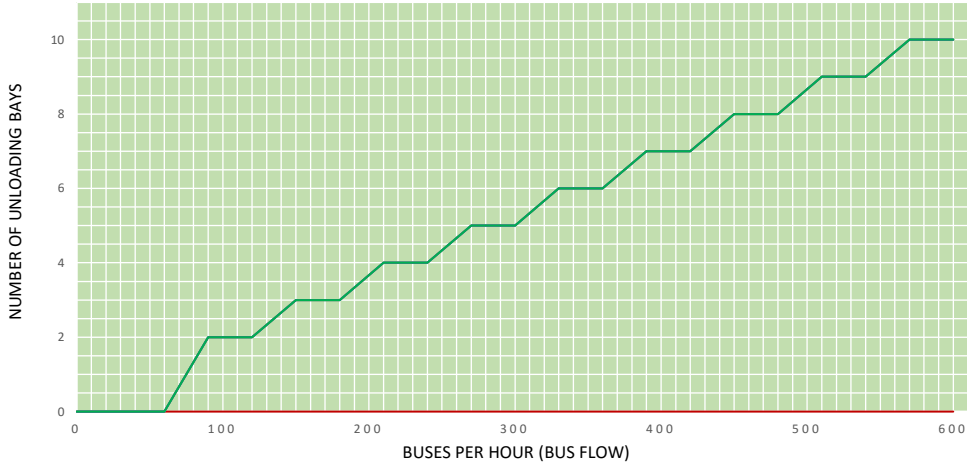

Idle Bus Bay Numbers

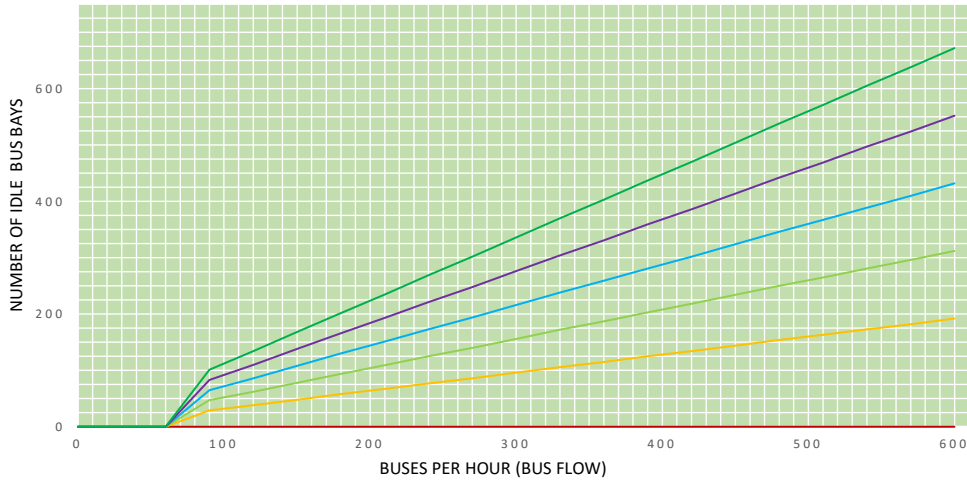

For layover time less than 10 min, it is not feasible to segregate the boarding, alighting and idle parking functions. For Layover time more than 10 min and bus flow more than 30 bus/hr, idle parking and offloading bays are introduced leading to a drop in boarding bay requirement.

- Layover time 10 min —
- Layover time 20 min —
- Layover time 30 min —
- Layover time 40 min —
- Layover time 50 min —
- Layover time 60 min —

Typology	Local	B
Operation	Dynamic Bay	b

Bus Bay Numbers

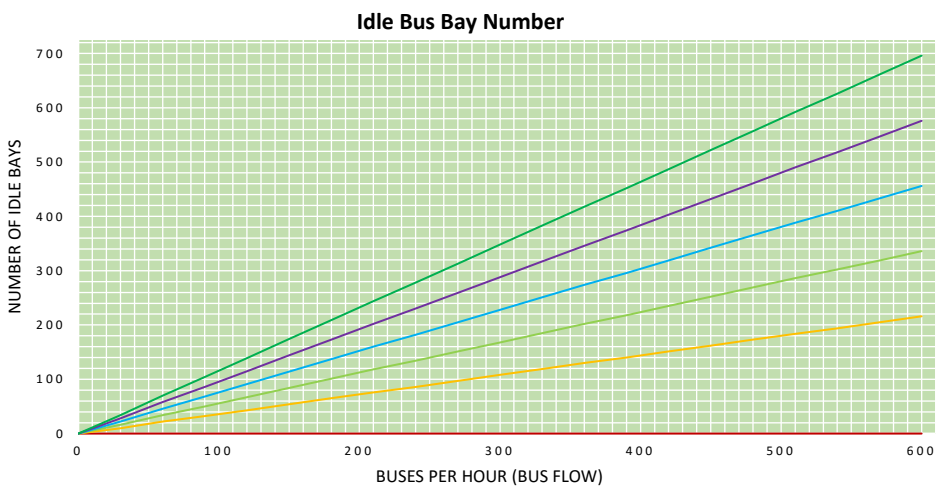
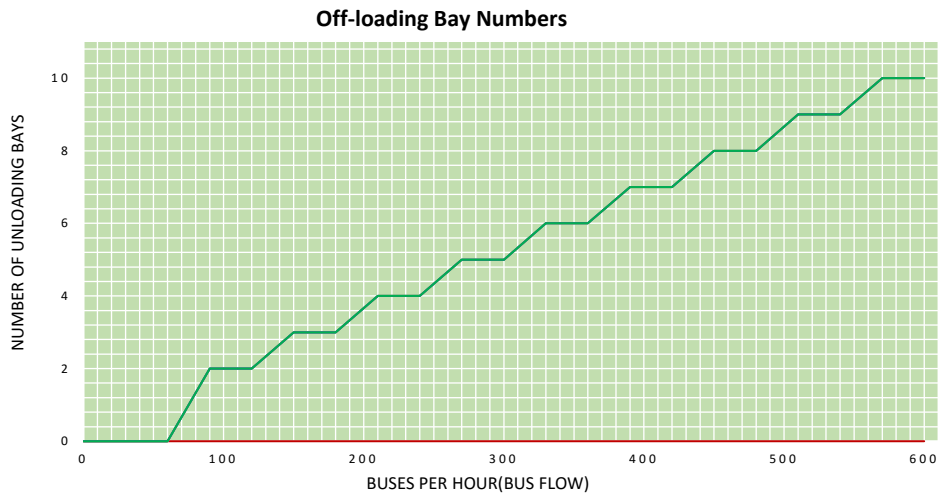
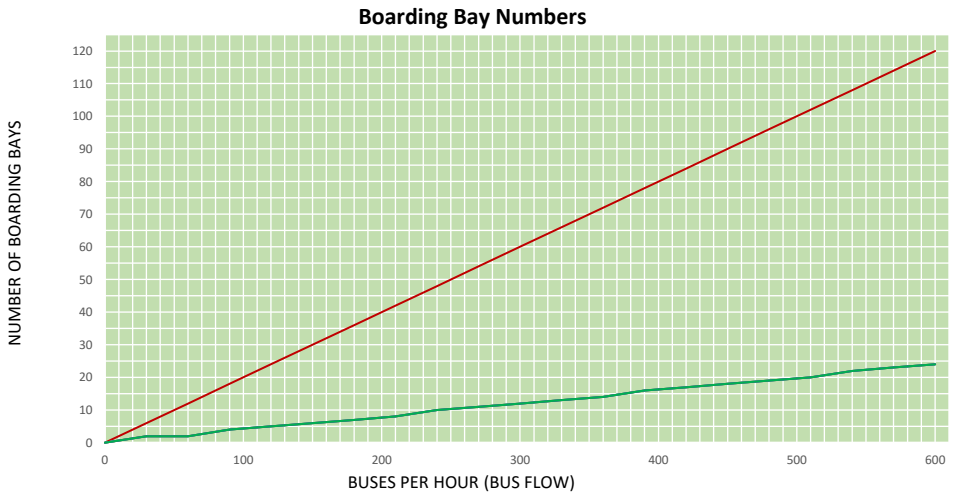

For layover time less than 10 min, it is not feasible to segregate the boarding, alighting and idle parking functions. For Layover time more than 10 min and bus flow more than 30 bus/hr, idle parking and offloading bays are introduced leading to a drop in boarding bay requirement.

- Layover time 10 min —
- Layover time 20 min —
- Layover time 30 min —
- Layover time 40 min —
- Layover time 50 min —
- Layover time 60 min —

Spatial Requirements

Ba

Typology	Local	B
Operation	Fixed route Bay	a

Passenger Accumulation and Passenger Flow

Passenger Accumulation

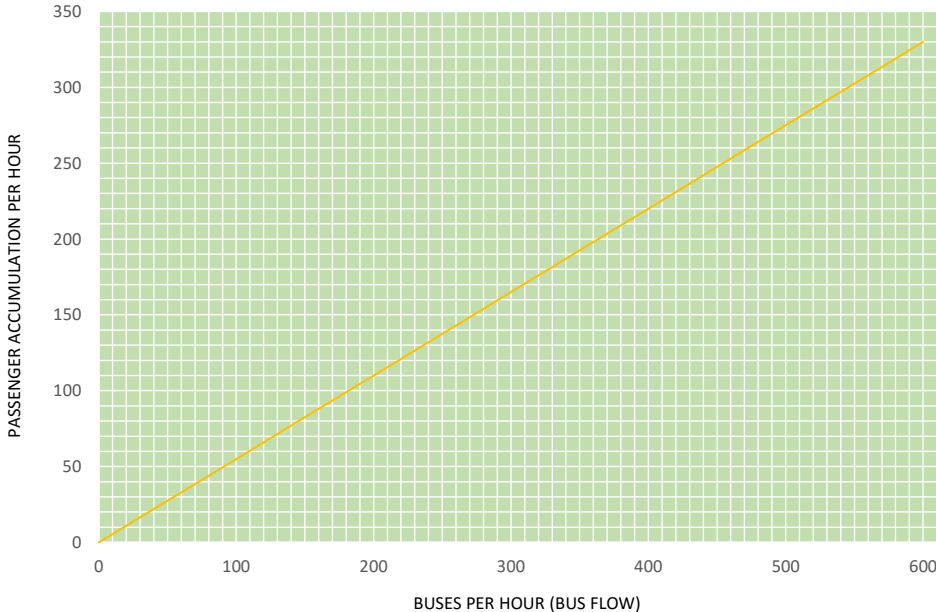

Passenger Flow

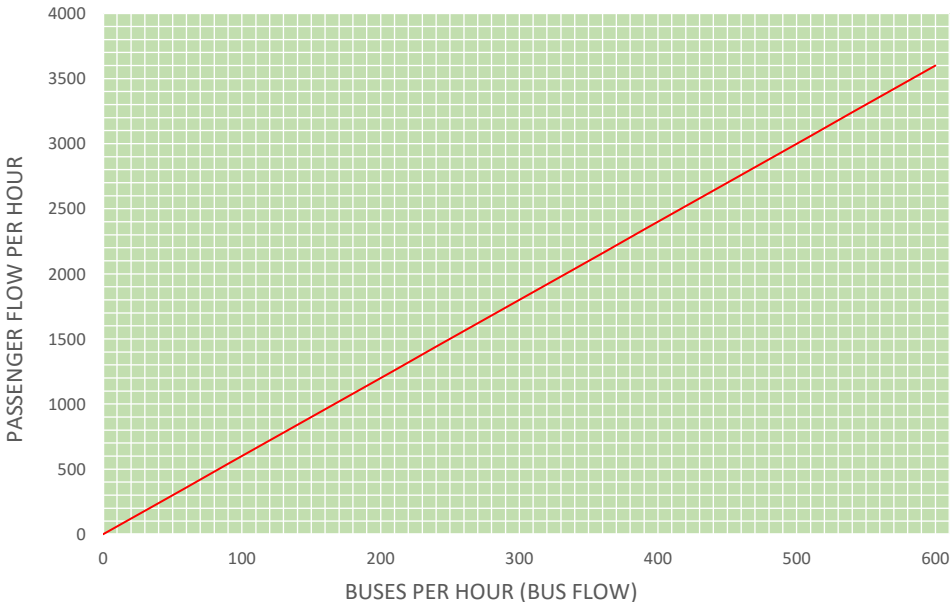

For all terminal sizes, With increasing bus flow per hour the passenger flow and passenger accumulation grows with a constant rate.

- Passenger Accumulation —
- Passenger flow per hour —

Typology	Local	B
Operation	Dynamic Bay	b

Passenger Accumulation and Passenger Flow

Passenger Accumulation

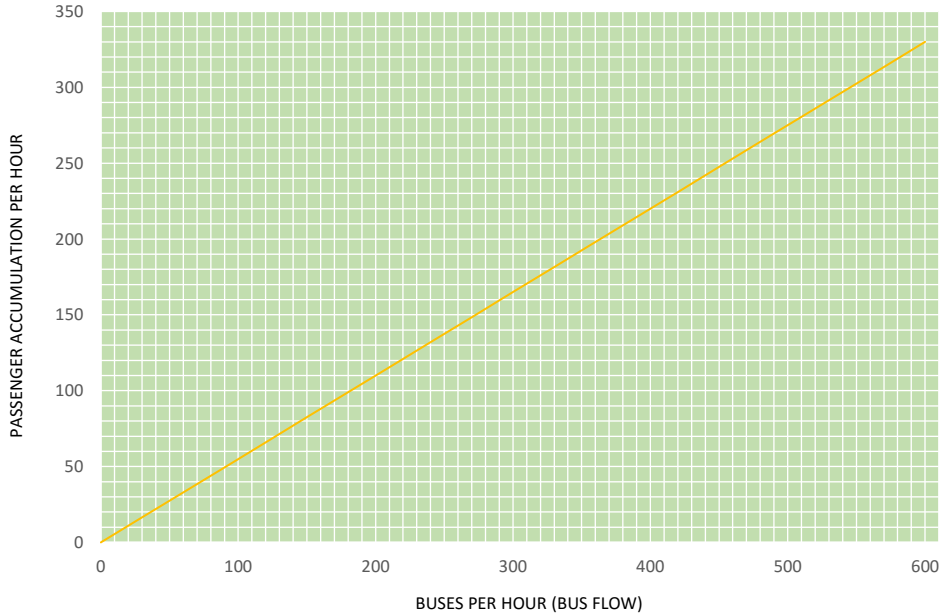

Passenger Flow

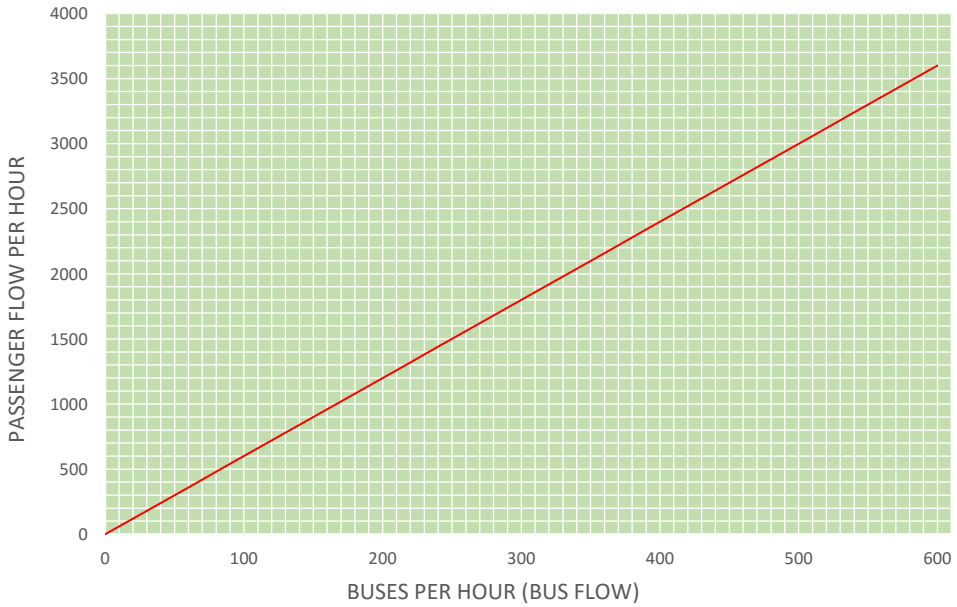

For all terminal sizes, With increasing bus flow per hour the passenger flow and passenger accumulation grows with a constant rate.

- Passenger Accumulation —
- Passenger flow per hour —

Spatial Requirements

Ba

Typology	Local	B
Operation	Fixed Route Bay	a

Floor Area Ratio (FAR)

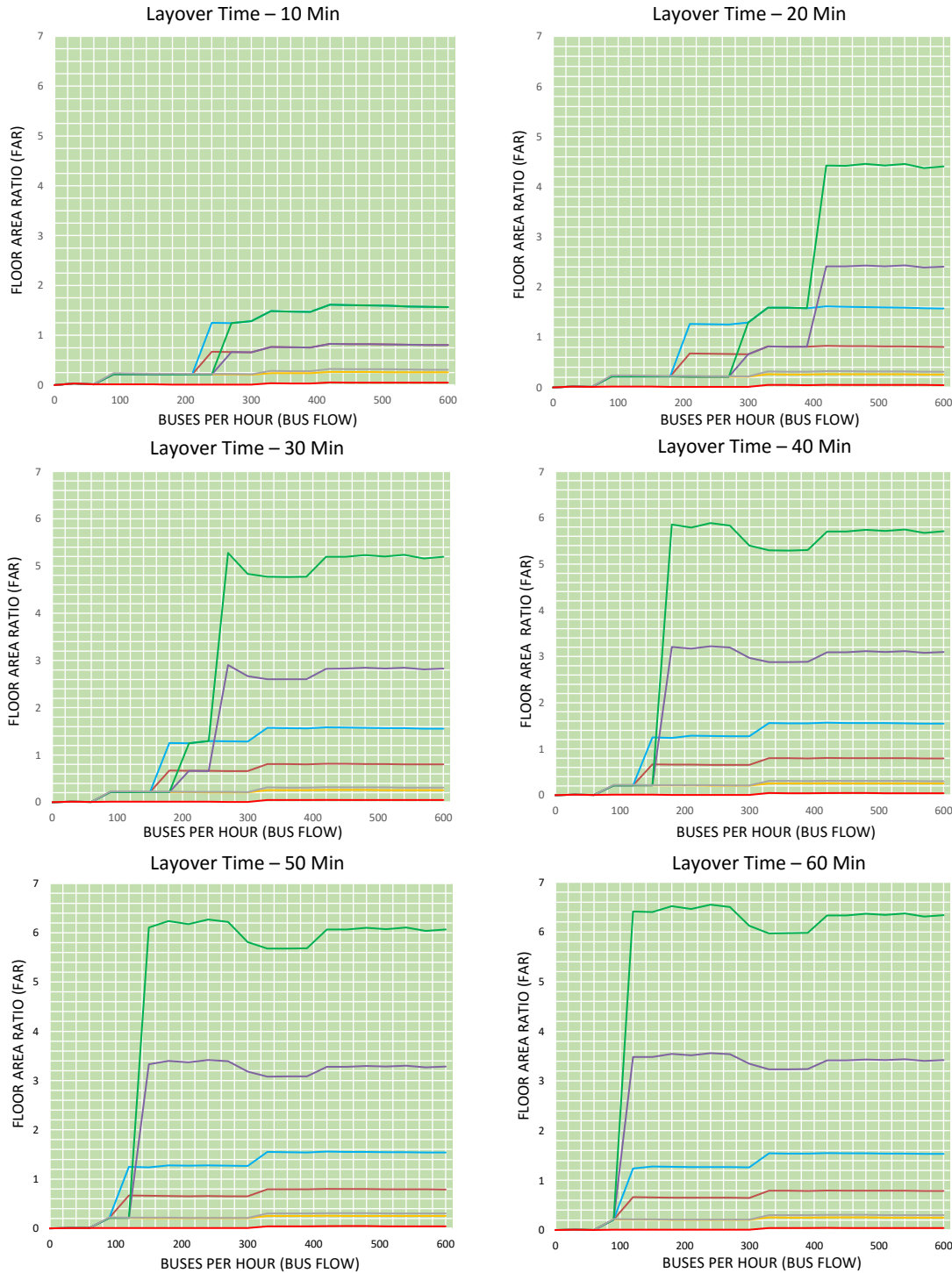

For all scenarios, FAR requirement surge is observed at 300 buses per hour. This is caused by increase in built up due to addition of amenities such as resting rooms for staff and eateries for passengers.

For scenarios 2 to 7, for all layover time, FAR requirement surge is observed at 90 buses per hour. This surge is attributed to addition of commercial built up, for offsetting the terminal development cost.

For scenarios 3 to 6, for all layover time, surges at different levels is attributed to shifting of car parking and idle bus parking from at grade (part of open area) to multi level (component of built up area).

- | | | | |
|---|---|--|---|
| 1. Without Real estate Development, at grade Parking (Car & Bus) | — | 5. With Real Estate development, Multilevel (Ramp) Car and Multilevel (Ramp) Bus parking | — |
| 2. With Real estate Development, at grade Parking (Car & Bus) | — | 6. With Real Estate development, Multilevel (Mechanical) Car and Multilevel (Ramp) Bus parking | — |
| 3. With Real Estate development, Multilevel (Ramp) Car and (At grade) Bus parking | — | 7. With Real estate Development, Basement Parking Car parking & at grade Bus Parking | — |
| 4. With Real Estate development, Multilevel (Mechanical) Car and (At grade) Bus parking | — | | |

Typology	Local	B
Operation	Dynamic Bay	b

Floor Area Ratio (FAR)

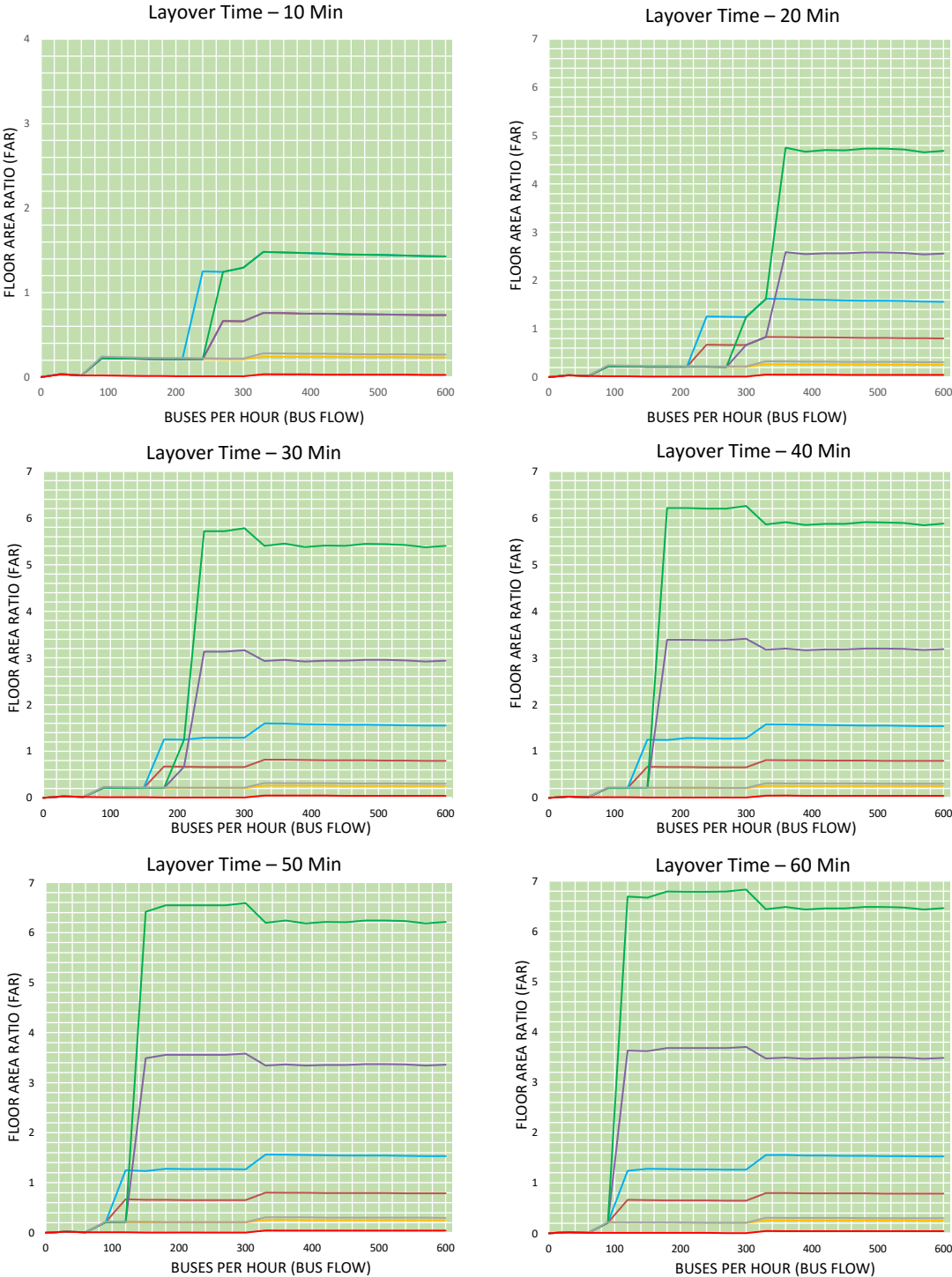

For all scenarios, FAR requirement surge is observed at 300 buses per hour. This is caused by increase in built up due to addition of amenities such as resting rooms for staff and eateries for passengers.

For scenarios 2 to 7, for all layover time, FAR requirement surge is observed at 90 buses per hour. This surge is attributed to addition of commercial built up, for offsetting the terminal development cost.

For scenarios 3 to 6, for all layover time, surges at different levels is attributed to shifting of car parking and idle bus parking from at grade (part of open area) to multi level (component of built up area).

- 1. Without Real estate Development, at grade Parking (Car & Bus) —
- 2. With Real estate Development, at grade Parking (Car & Bus) —
- 3. With Real Estate development, Multilevel (Ramp) Car and (At grade) Bus parking —
- 4. With Real Estate development, Multilevel (Mechanical) Car and (At grade) Bus parking —
- 5. With Real Estate development, Multilevel (Ramp) Car and Multilevel (Ramp) Bus parking —
- 6. With Real Estate development, Multilevel (Mechanical) Car and Multilevel (Ramp) Bus parking —
- 7. With Real Estate Development, Basement Parking Car parking & at grade Bus Parking —

Spatial Requirements

Ba

Typology	Local	B
Operation	Fixed Route Bay	a

Total Built up Area

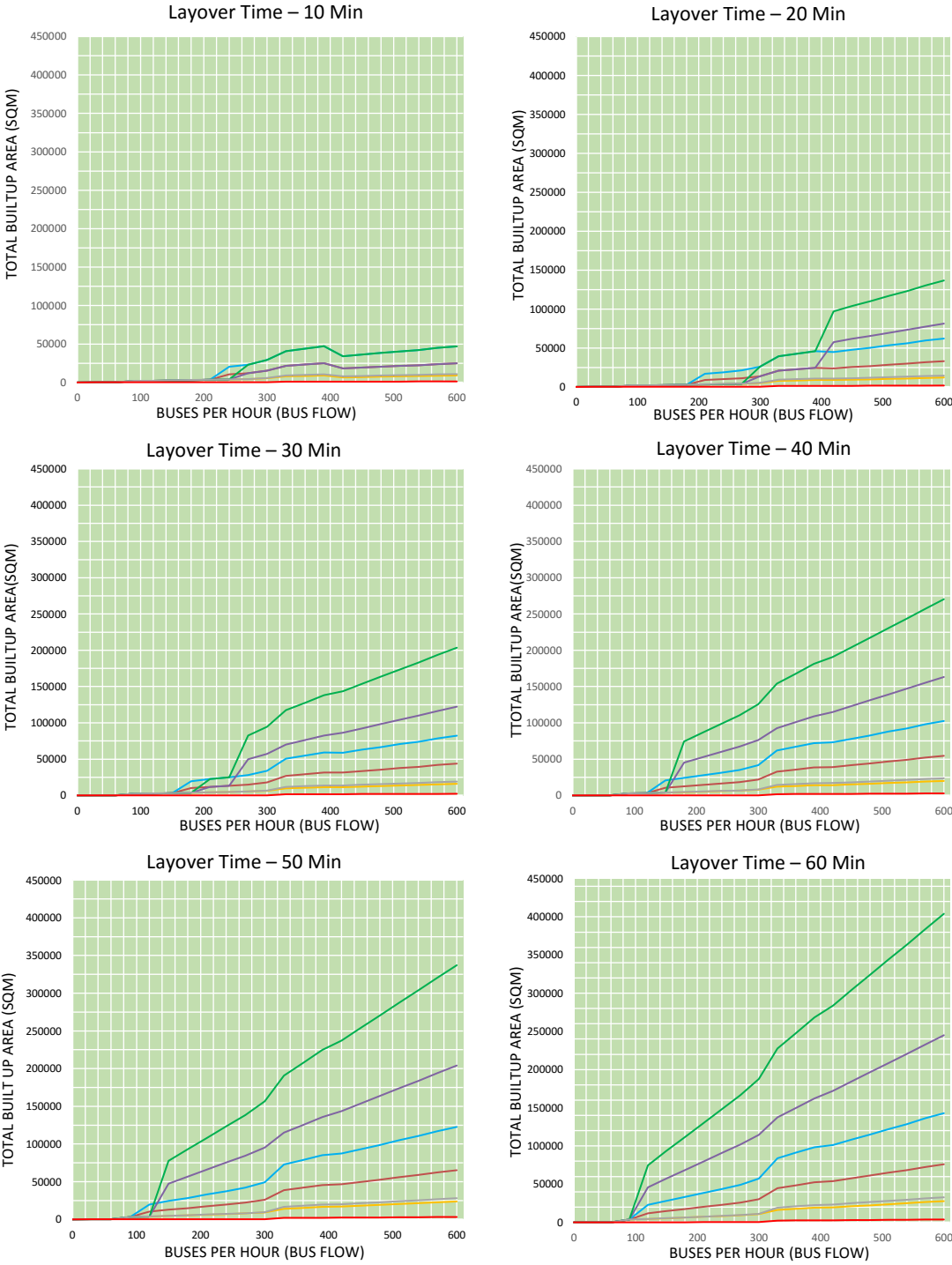

For all scenarios, surge is observed at 300 buses per hour. This is caused by increase in built up due to addition of amenities such as resting rooms for staff and eateries for passengers.

For scenarios 2 to 7, for all layover time, surge is observed at 90 buses per hour. This surge is attributed to addition of commercial built up, for offsetting the terminal development cost.

For scenarios 3 to 6, for all layover time, surges at different levels is attributed to shifting of car parking and idle bus parking from at grade (part of open area) to multi level (component of built up area).

- 1. Without Real estate Development, at grade Parking (Car & Bus) —
- 2. With Real estate Development, at grade Parking (Car & Bus) —
- 3. With Real Estate development, Multilevel (Ramp) Car and (At grade) Bus parking —
- 4. With Real Estate development, Multilevel (Mechanical) Car and (At grade) Bus parking —
- 5. With Real Estate development, Multilevel (Ramp) Car and Multilevel (Ramp) Bus parking —
- 6. With Real Estate development, Multilevel (Mechanical) Car and Multilevel (Ramp) Bus parking —
- 7. With Real estate Development, Basement Parking Car parking & at grade Bus Parking —

Typology	Local	B
Operation	Dynamic Bay	b

Total Built up Area

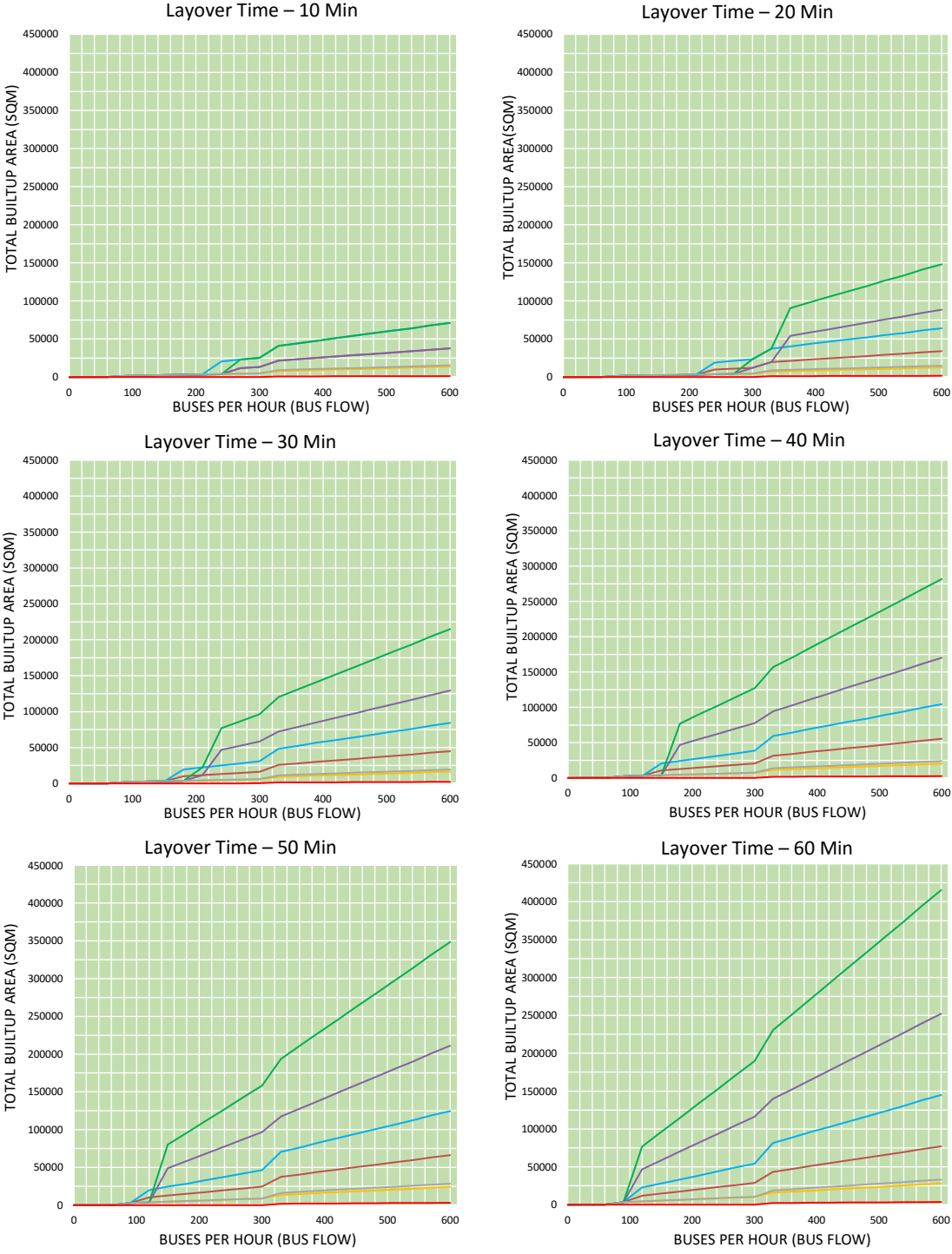

For all scenarios, surge is observed at 300 buses per hour. This is caused by increase in built up due to addition of amenities such as resting rooms for staff and eateries for passengers.

For scenarios 2 to 7, for all layover time, surge is observed at 90 buses per hour. This surge is attributed to addition of commercial built up, for offsetting the terminal development cost.

For scenarios 3 to 6, for all layover time, surges at different levels is attributed to shifting of car parking and idle bus parking from at grade (part of open area) to multi level (component of built up area).

- 1. Without Real estate Development, at grade Parking (Car & Bus)
- 2. With Real estate Development, at grade Parking (Car & Bus)
- 3. With Real Estate development, Multilevel (Ramp) Car and (At grade) Bus parking
- 4. With Real Estate development, Multilevel (Mechanical) Car and (At grade) Bus parking
- 5. With Real Estate development, Multilevel (Ramp) Car and Multilevel (Ramp) Bus parking
- 6. With Real Estate development, Multilevel (Mechanical) Car and Multilevel (Ramp) Bus parking
- 7. With Real estate Development, Basement Parking Car parking & at grade Bus Parking

Spatial Requirements

Ba

Typology	Local	B
Operation	Fixed Route Bay	a

Parking Built up area

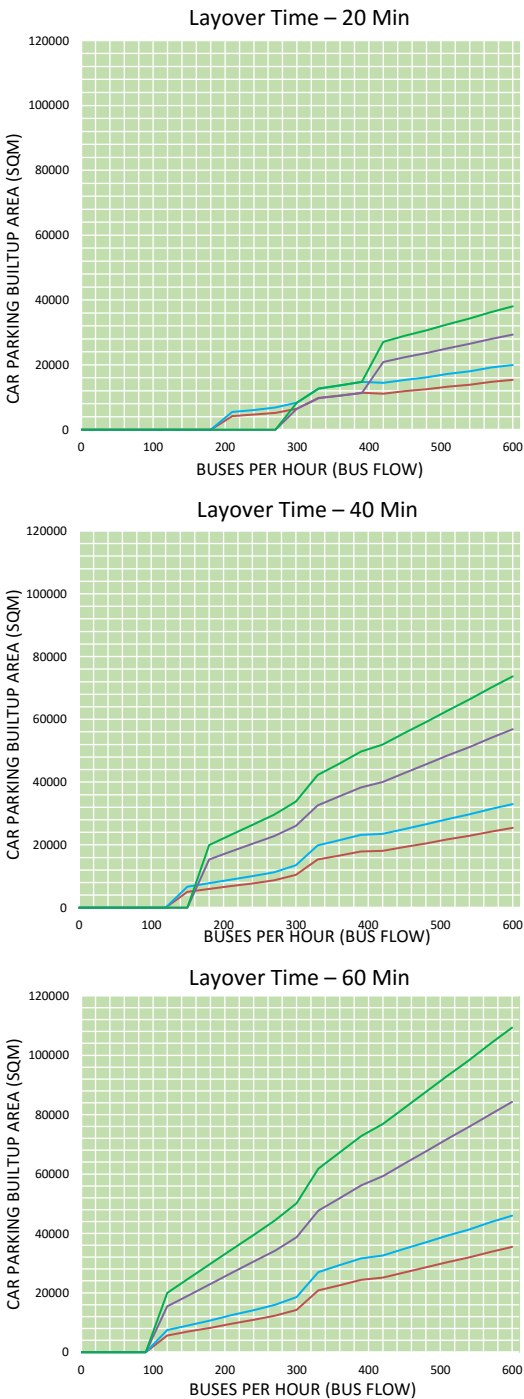
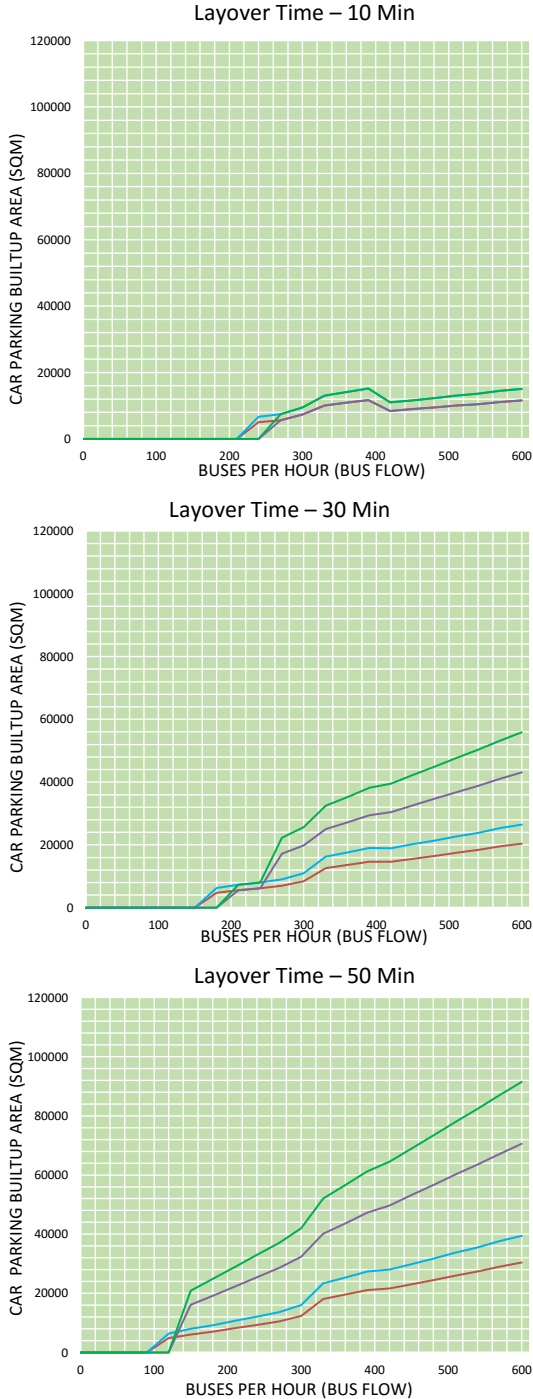

For parking built up area, out of all 7 scenarios only the 4 scenarios which accounts for multilevel car parking and bus parking are considered .i.e.Scenario 3,4, 5 and 6 respectively

Parking built up appears for scenario 3 to 6 is the total built up for structured parking. It appears when car parking demand exceeds minimum threshold of 120 and bus idle parking demand exceeds minimum threshold value of 130. The surges and drops in parking built up area required correspond to surges and drops with car and bus parking demand.

- 3. With Real Estate development, Multilevel (Ramp) Car and (At grade) Bus parking.
- 4. With Real Estate development, Multilevel (Mechanical) Car and (At grade) Bus parking.

- 5. With Real Estate development, Multilevel (Ramp) Car and Multilevel (Ramp) Bus parking
- 6. With Real Estate development, Multilevel (Mechanical) Car and Multilevel (Ramp) Bus parking

Typology	Local	B
Operation	Dynamic Bay	a

Parking Built up area

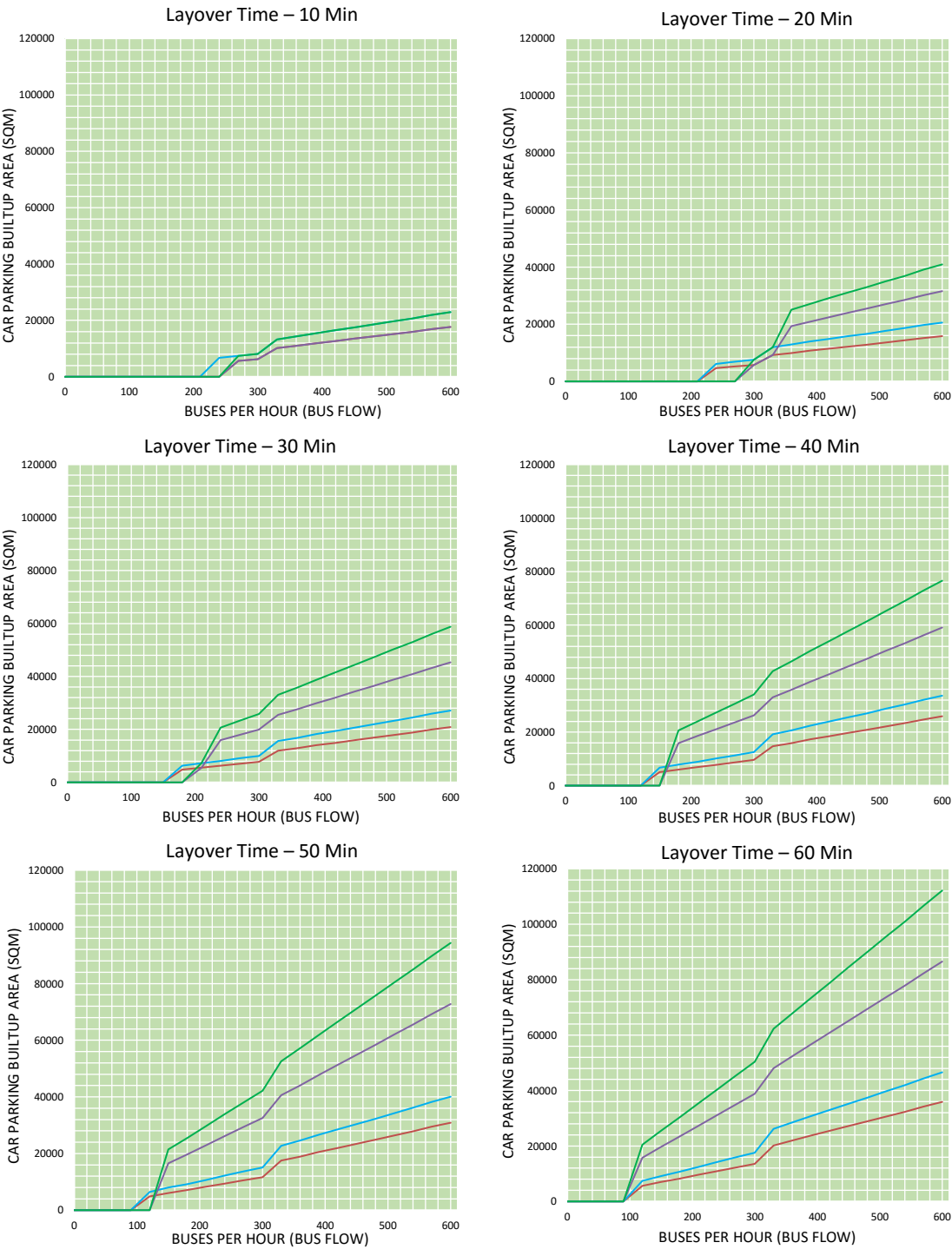

For parking built up area, out of all 7 scenarios only the 4 scenarios which accounts for multilevel car parking and bus parking are considered .i.e.Scenario 3,4, 5 and 6 respectively

Parking built up appears for scenario 3 to 6 is the total built up for structured parking. It appears when car parking demand exceeds minimum threshold of 120 and bus idle parking demand exceeds minimum threshold value of 130. The surges and drops in parking built up area required correspond to surges and drops with car and bus parking demand.

- 3. With Real Estate development, Multilevel (Ramp) Car and (At grade) Bus parking. —
- 4. With Real Estate development, Multilevel (Mechanical) Car and (At grade) Bus parking. —
- 5. With Real Estate development, Multilevel (Ramp) Car and Multilevel (Ramp) Bus parking. —
- 6. With Real Estate development, Multilevel (Mechanical) Car and Multilevel (Ramp) Bus parking. —

Spatial Requirements

Scenario - 1 : Without Real estate Development (No commercial) and at grade car & Bus Parking.

Ba

Typology	Local	B
Operation	Fixed Route Bay	a

Site Area Distribution

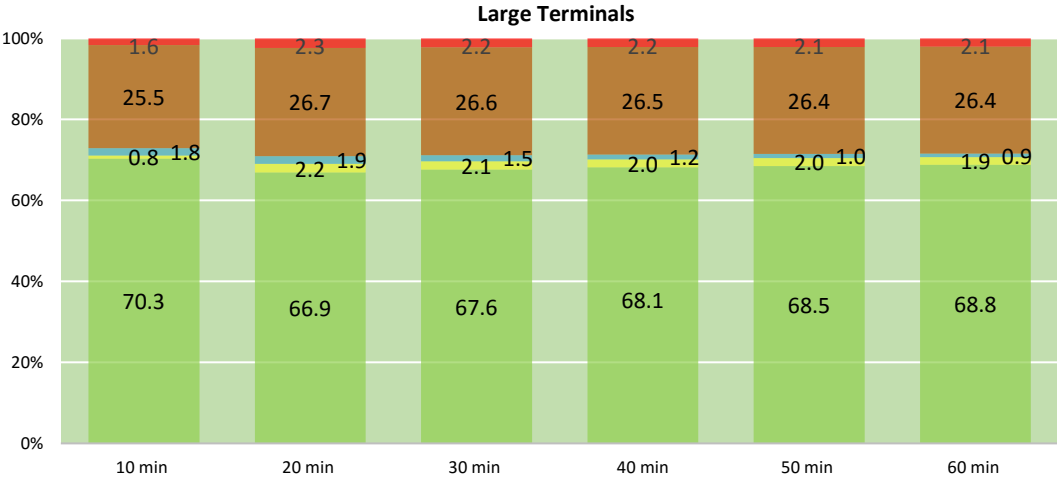
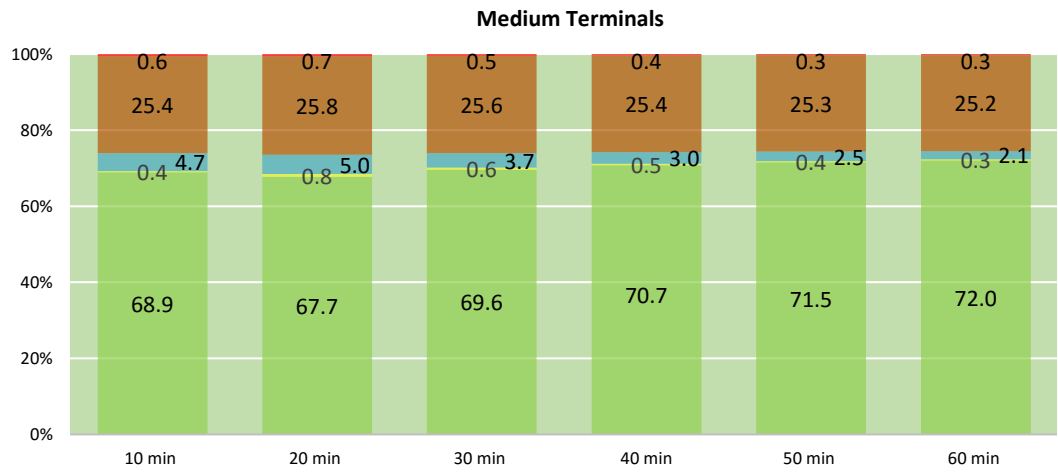
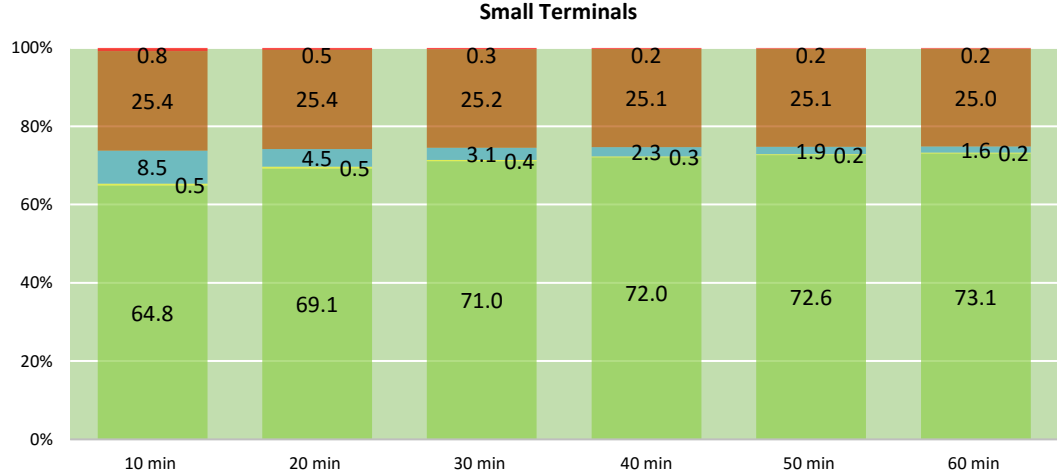

For all terminal sizes, increasing layover time, leads to increasing bus accumulation which leads to increased bus parking area requirement. This results in reduction of percentage of site area under other different functions.

In this scenario, private car parking demand remains minimal as parking demand in local terminal is mainly attributed to commercial/real estate development on the site.



*The values represented here correspond 60 buses per hour for small terminal, 150 buses per hour for medium terminal and 390 buses per hour for large terminals

Scenario - 1 : Without Real estate Development (No commercial) and at grade car & Bus Parking.

Typology	Local	B
Operation	Fixed Route Bay	a

Open Area Distribution

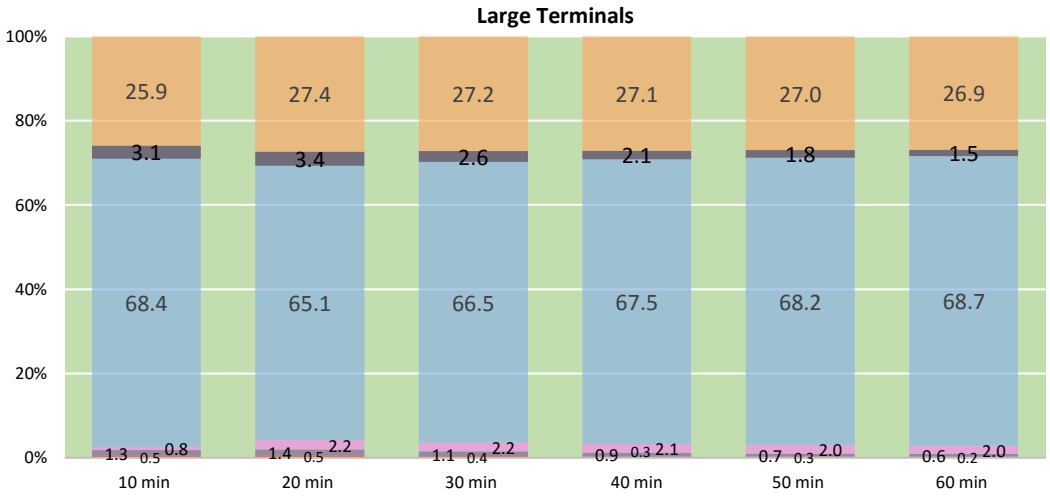
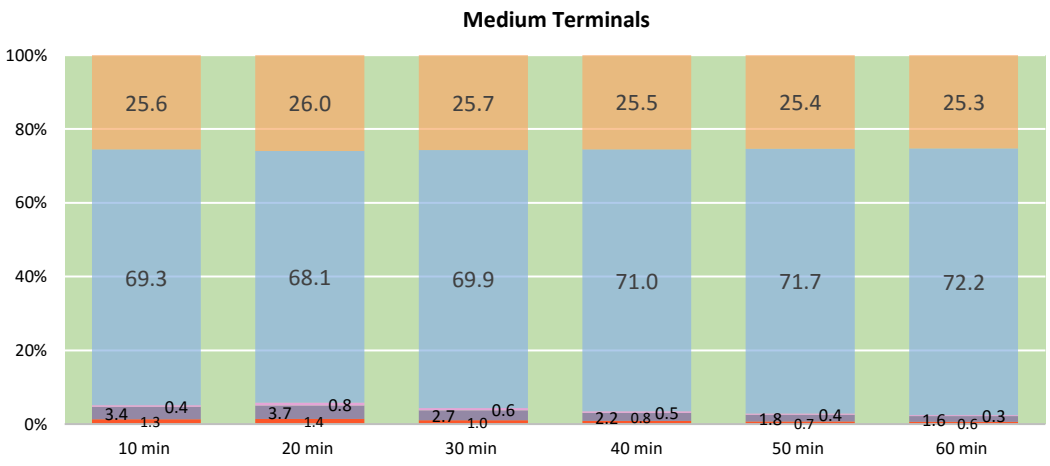
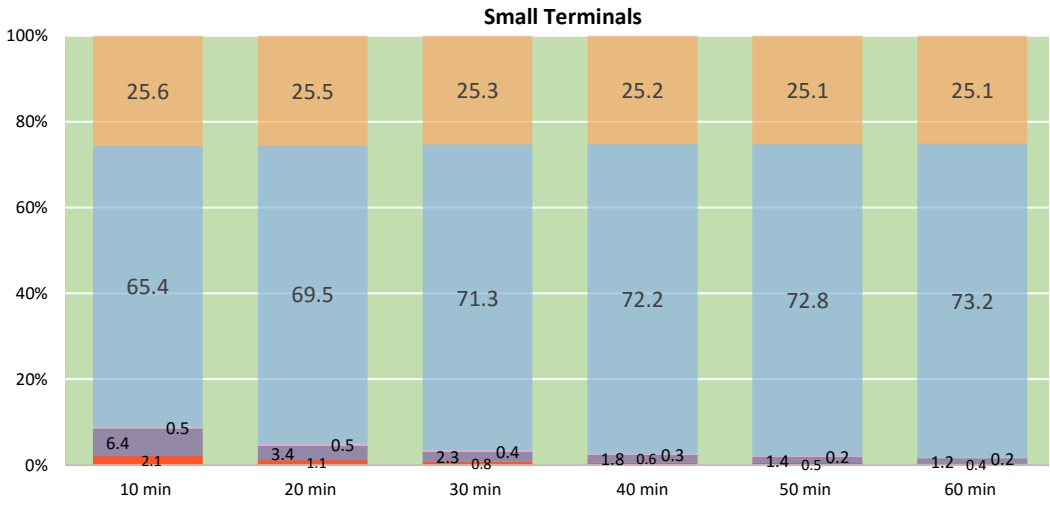

For all terminal sizes, increasing layover time, leads to increasing bus accumulation which leads to increased bus parking area requirement. This results in reduction of percentage of open area under other different functions.

Drop Off (red), Pick up (purple), Car Parking (pink), Bus Parking (light blue), Circulation area (medium blue), Workshop area (orange), Pedestrian plaza (grey), Other (dark blue)

*The values represented here correspond 60 buses per hour for small terminal, 150 buses per hour for medium terminal and 390 buses per hour for large terminals

Spatial Requirements

Scenario 2: With Real estate Development, at-grade Parking (Car & Bus).

Ba

Typology	Local	B
Operation	Fixed Route Bay	a

Site Area Distribution

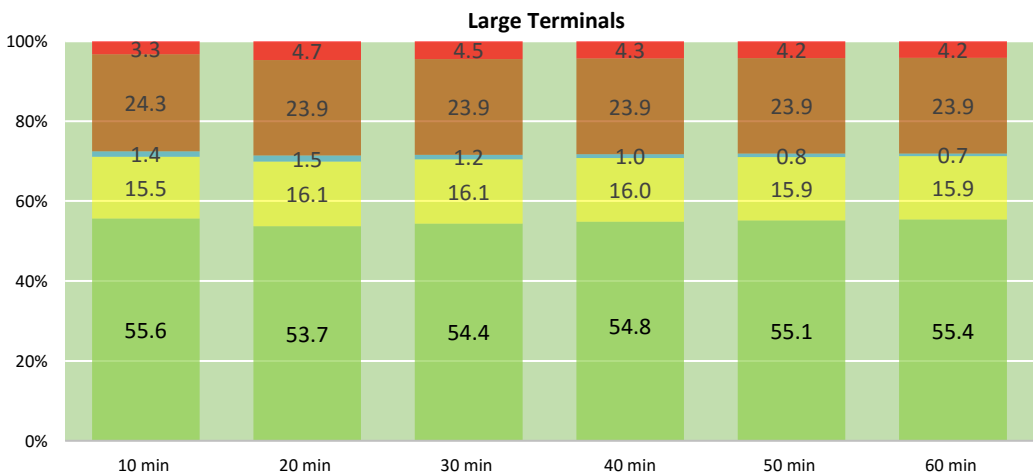
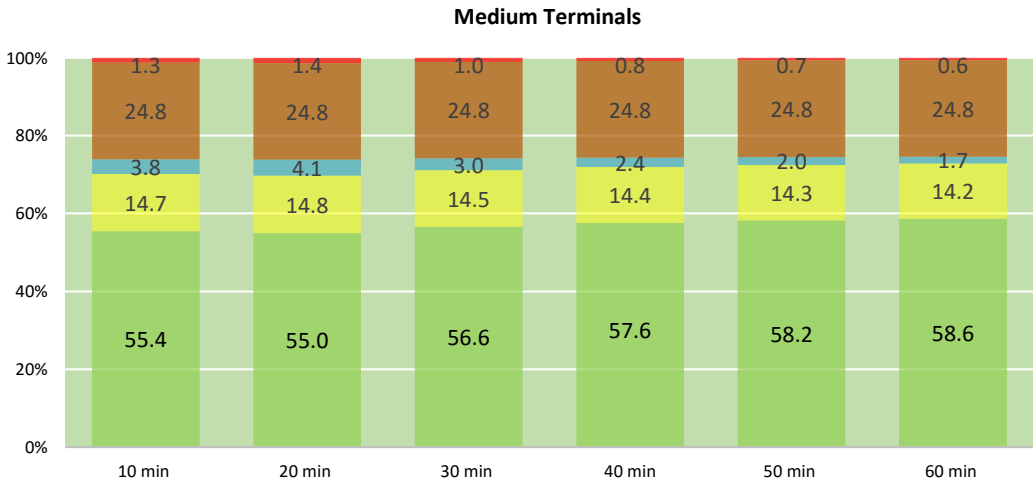
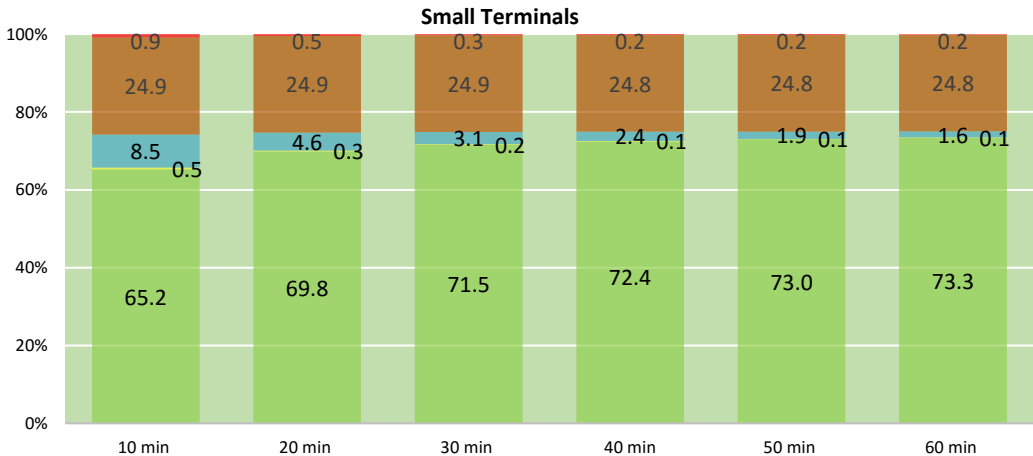

For all terminal sizes, increasing layover time, leads to increasing bus accumulation which leads to increased bus parking area requirement. This results in reduction in percentage of site area under other different functions.

Percentage of car/private vehicle parking area increases significantly for large and medium bus terminals, over small terminals. This is to accommodate increased demand from commercial/real estate development, taken up for these terminal sizes in order to offset the cost of infrastructure development.

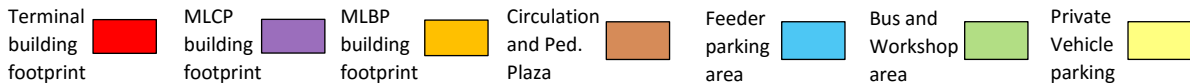

*The values represented here correspond 60 buses per hour for small terminal, 150 buses per hour for medium terminal and 390 buses per hour for large terminals

Scenario 2 : With Real estate Development, at-grade Parking (Car & Bus).

Typology	Local	B
Operation	Fixed Route Bay	a

Open Area Distribution

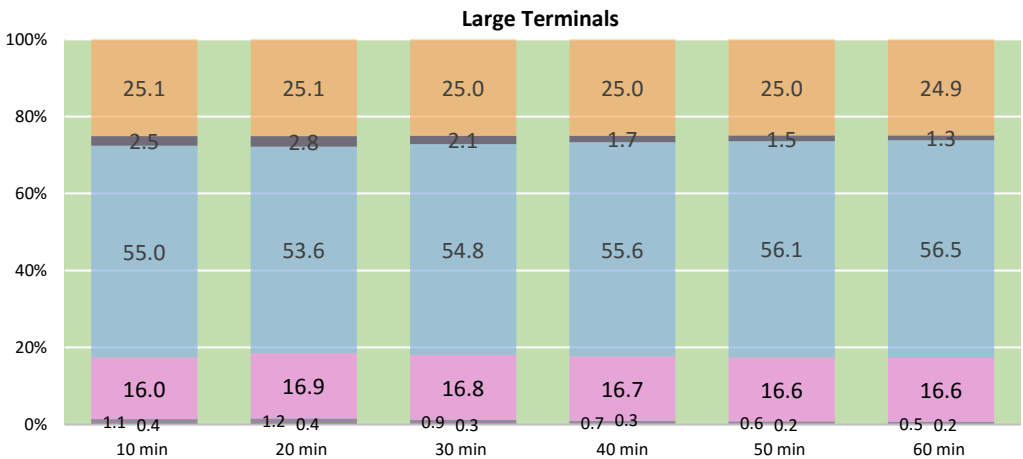
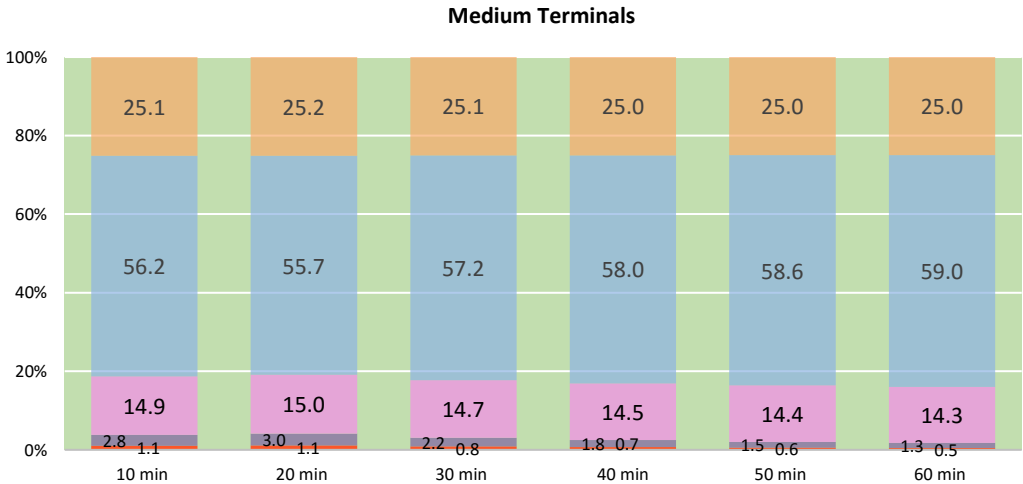
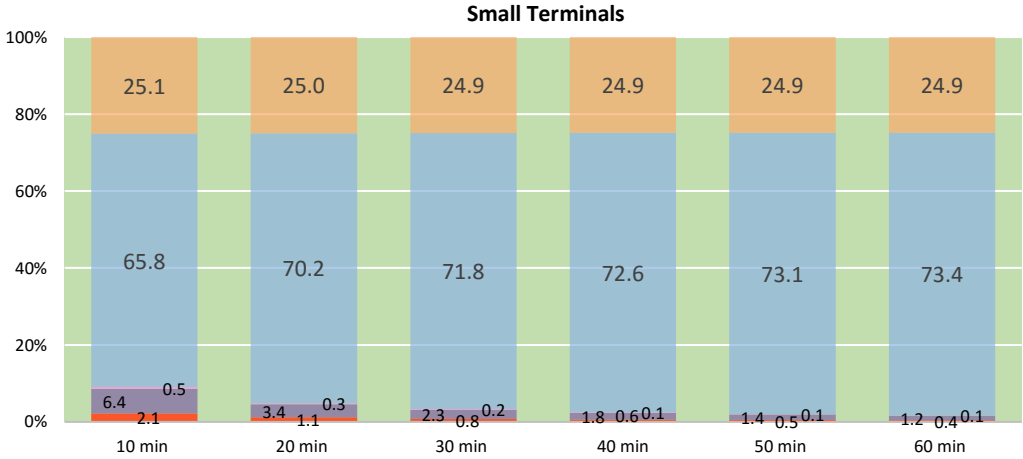

For all terminal sizes, increasing layover time, leads to increasing bus accumulation which leads to increased bus parking area requirement. This results in reduction of percentage of open area under other different functions.

Small terminals have significantly lower area dedicated to car/private vehicle parking as compared to medium and large terminals. This is because car parking requirement surges due to demand for real estate development to offset the cost of medium and large terminal development.

Drop Off ■ Pick up ■ Car Parking ■ Bus Parking ■ Circulation area ■ Workshop area ■ Pedestrian plaza ■

*The values represented here correspond 60 buses per hour for small terminal, 150 buses per hour for medium terminal and 390 buses per hour for large terminals

Spatial Requirements

Scenario -3 : With Real Estate development, Multilevel (Ramp) Car and (At grade) Bus parking.

Ba

Typology	Local	B
Operation	Fixed Route Bay	a

Site Area Distribution

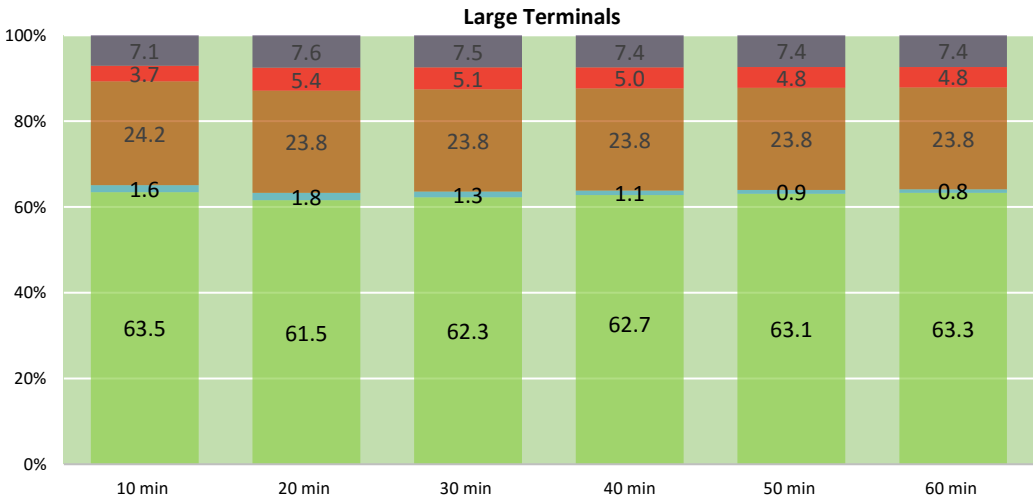
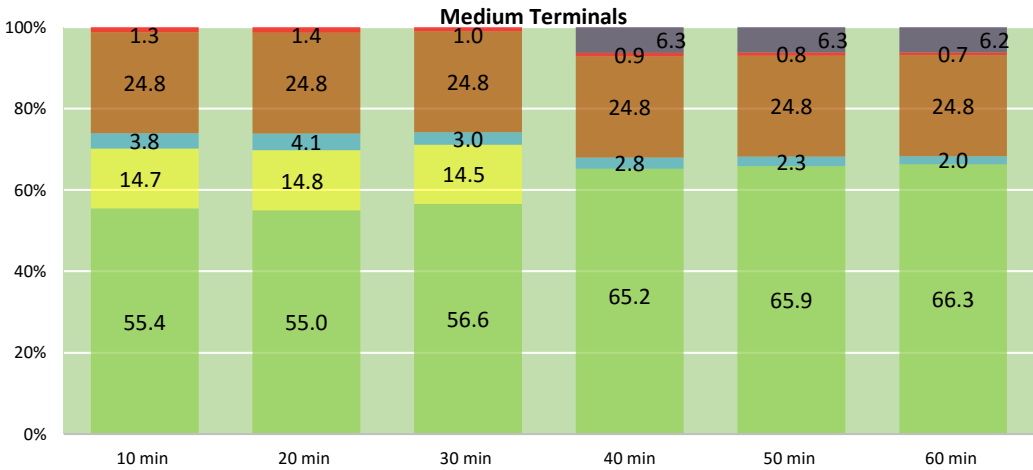
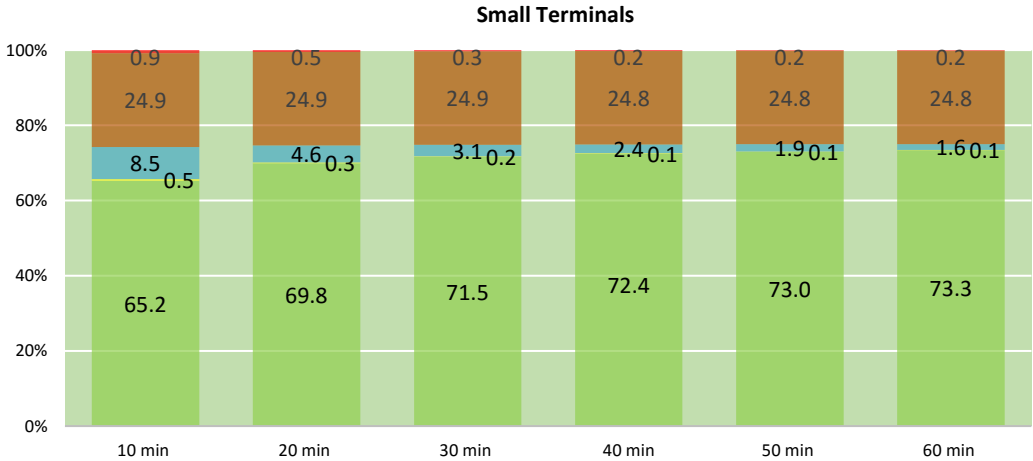

For all terminal sizes, increasing layover time, leads to increasing bus accumulation which leads to increased bus parking area requirement. This results in reduction of percentage of site area under other different functions.

In this scenario, multi level car parking (MLCP) replaces at grade private vehicle parking in medium terminals with layover time 40 to 60 minutes and large terminals for all layover time. This is because for these terminal sizes car parking demand exceeds the minimum threshold requirement of 120 for a MLCP.

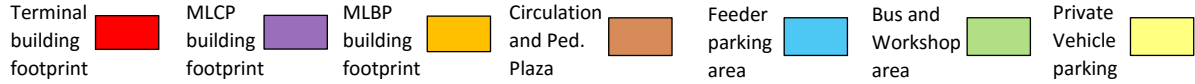

*The values represented here correspond 60 buses per hour for small terminal, 150 buses per hour for medium terminal and 390 buses per hour for large terminals

Scenario -3 : With Real Estate development, Multilevel (Ramp) Car and (At grade) Bus parking.

Typology	Local	B
Operation	Fixed Route Bay	a

Open Area Distribution

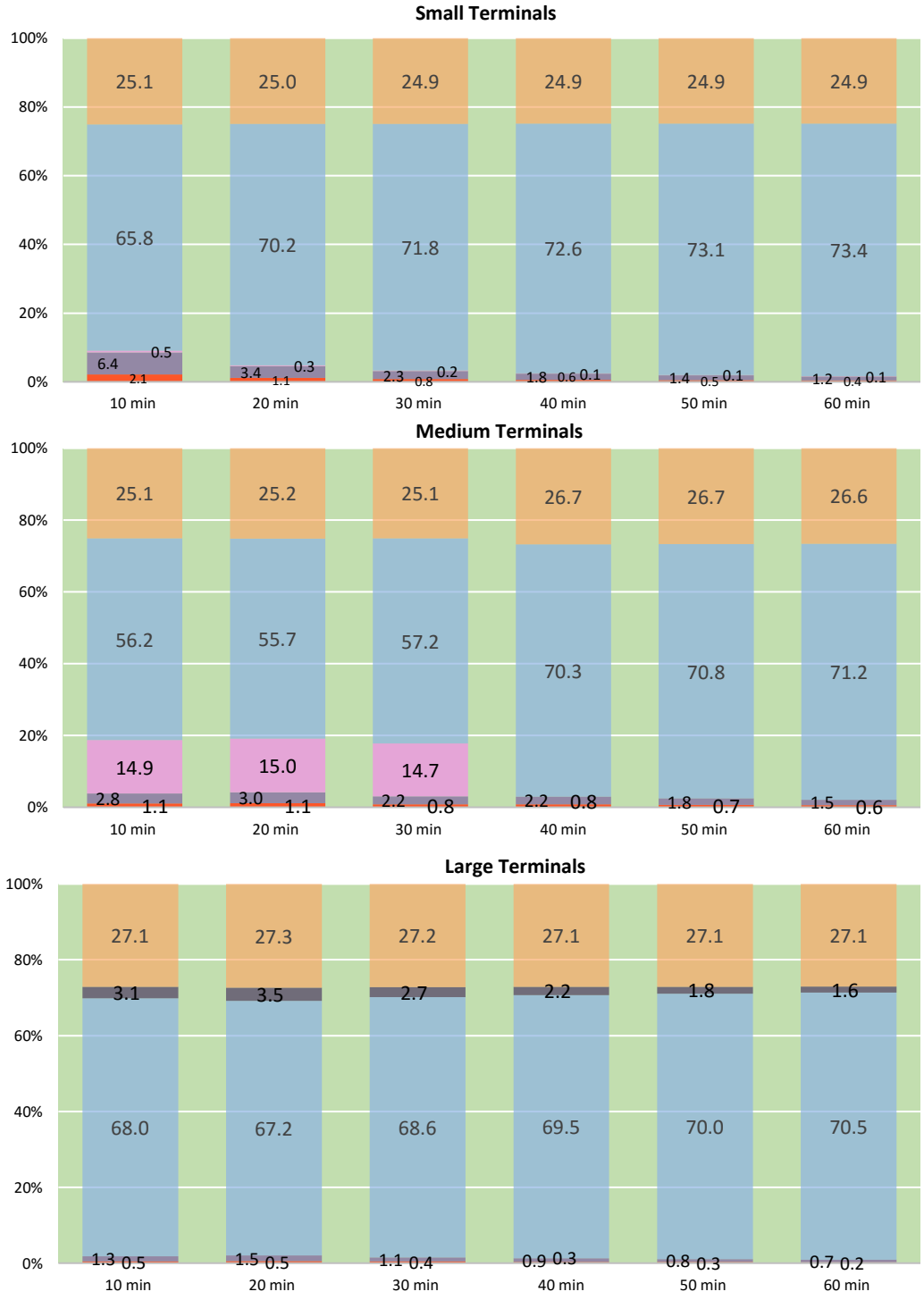

For all terminal sizes, increasing layover time, leads to increasing bus accumulation which leads to increased bus parking area requirement. This results in reduction of percentage of open area under other different functions.

Percentage of open area dedicated to car/private vehicle parking, for 40 to 60 minute layover time in medium terminals and all layover time in large terminals, is '0'. This is because for these terminal sizes (in this scenario) structured car parking is proposed when car parking requirement exceeds 120 ECS.

Drop Off Pick up Car Parking Bus Parking Circulation area Workshop area Pedestrian plaza

*The values represented here correspond 60 buses per hour for small terminal, 150 buses per hour for medium terminal and 390 buses per hour for large terminals

Spatial Requirements

Ba

Scenario -4 : With Real Estate development, Multilevel (Mechanical) Car parking and (At grade) Bus parking.

Typology	Local	B
Operation	Fixed Route Bay	a

Site Area Distribution

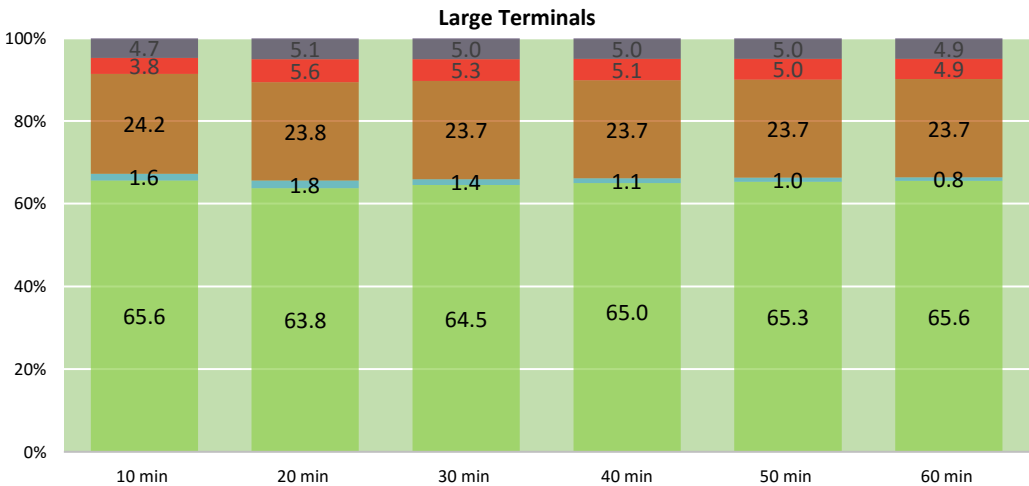
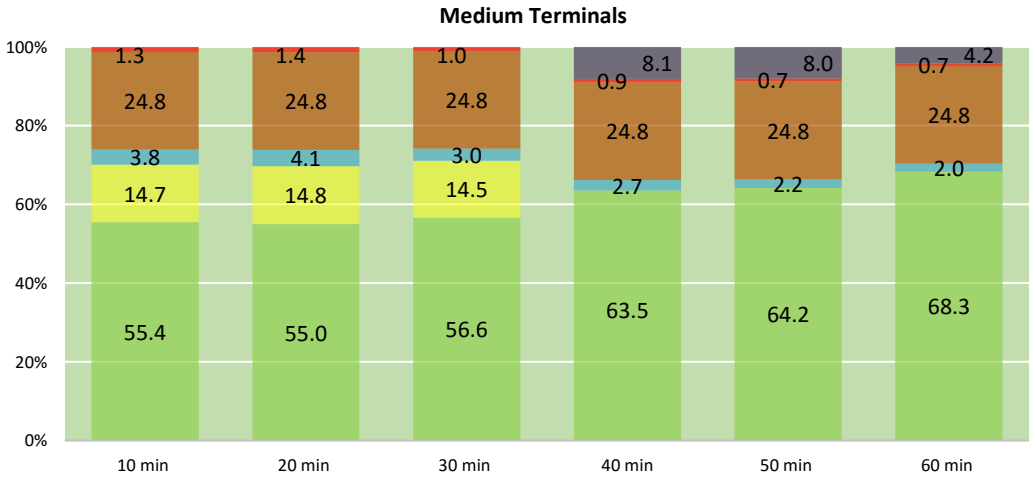
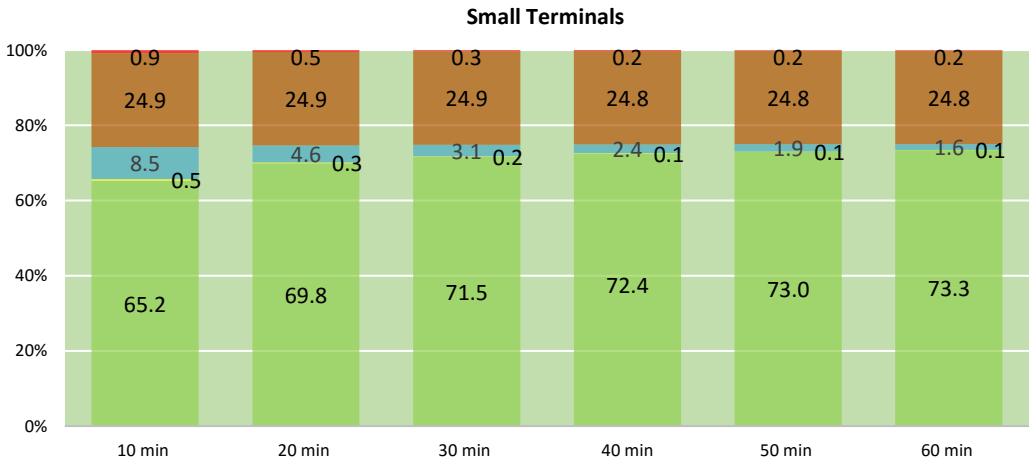

For all terminal sizes, increasing layover time, leads to increasing bus accumulation which leads to increased bus parking area requirement. This results in reduction of percentage of site area under other different functions.

In this scenario, multi level car parking (MLCP) replaces at grade private vehicle parking in medium terminals with layover time 40 to 60 minutes and large terminals for all layover time. This is because for these terminal sizes car parking demand exceeds the minimum threshold requirement of 120 for a MLCP.

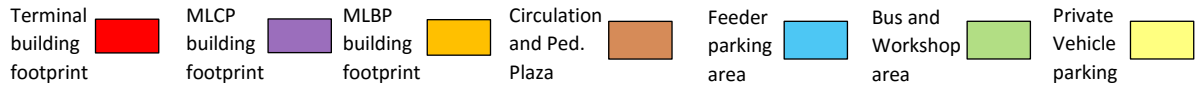

*The values represented here correspond 60 buses per hour for small terminal, 150 buses per hour for medium terminal and 390 buses per hour for large terminals

Scenario -4 : With Real Estate development, Multilevel (Mechanical) Car parking and (At grade) Bus parking.

Typology	Local	B
Operation	Fixed Route Bay	a

Open Area Distribution

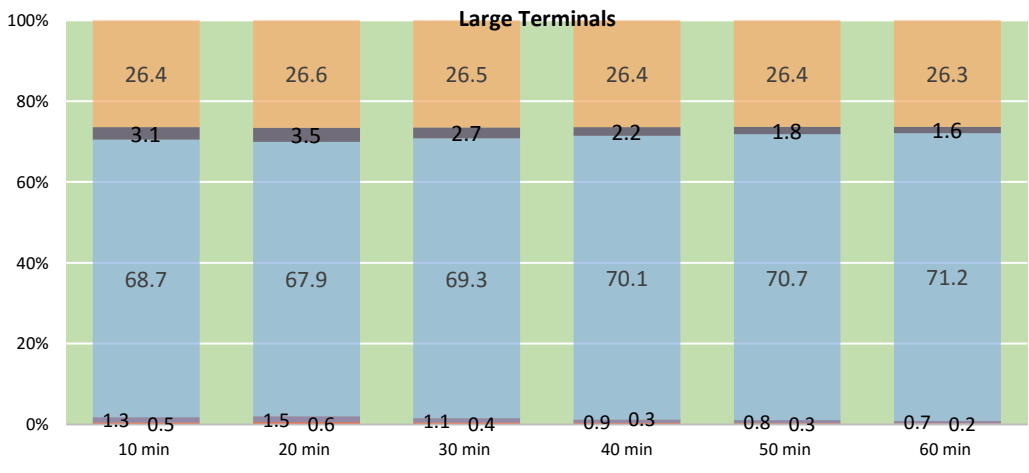
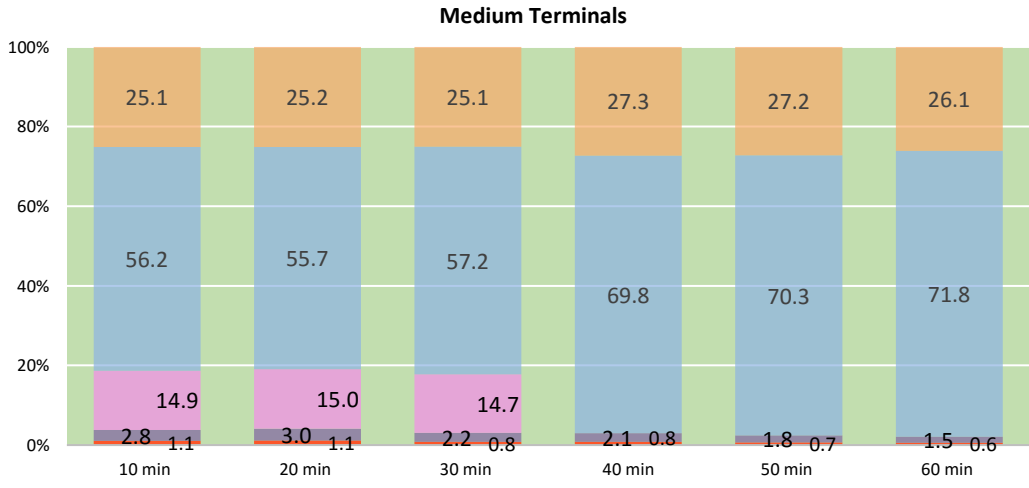
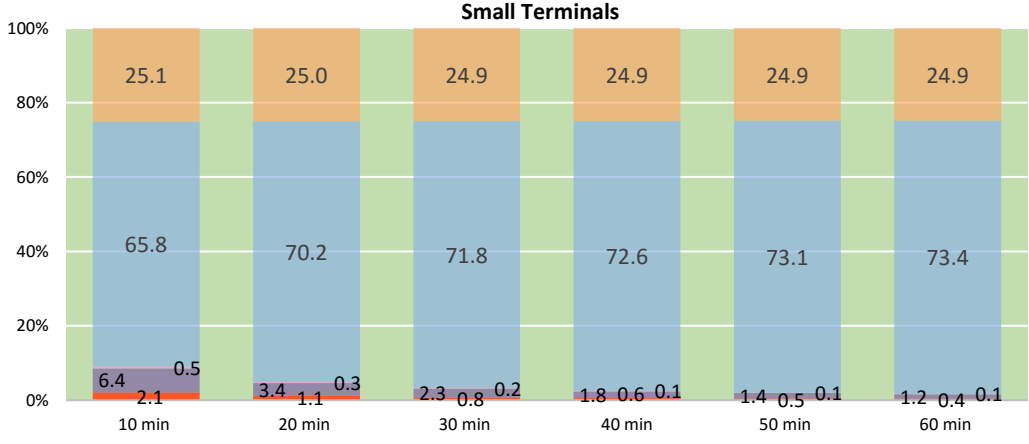

For all terminal sizes, increasing layover time, leads to increasing bus accumulation which leads to increased bus parking area requirement. This results in reduction of percentage of open area under other different functions.

Percentage of open area dedicated to car/private vehicle parking, for 40 to 60 minute layover time in medium terminals and all layover time in large terminals, is '0'. This is because for these terminal sizes (in this scenario) structured car parking is proposed when car parking requirement exceeds 120 ECS.

Drop Off (red) Pick up (purple) Car Parking (pink) Bus Parking (light blue) Circulation area (medium blue) Workshop area (orange) Pedestrian plaza (grey) Other (dark blue)

*The values represented here correspond 60 buses per hour for small terminal, 150 buses per hour for medium terminal and 390 buses per hour for large terminals

Spatial Requirements

Ba

Typology	Local	B
Operation	Fixed Route Bay	a

Scenario -5 : With Real Estate development, Multilevel (Ramp) Car parking and Multilevel (Ramp) Bus parking.

Site Area Distribution

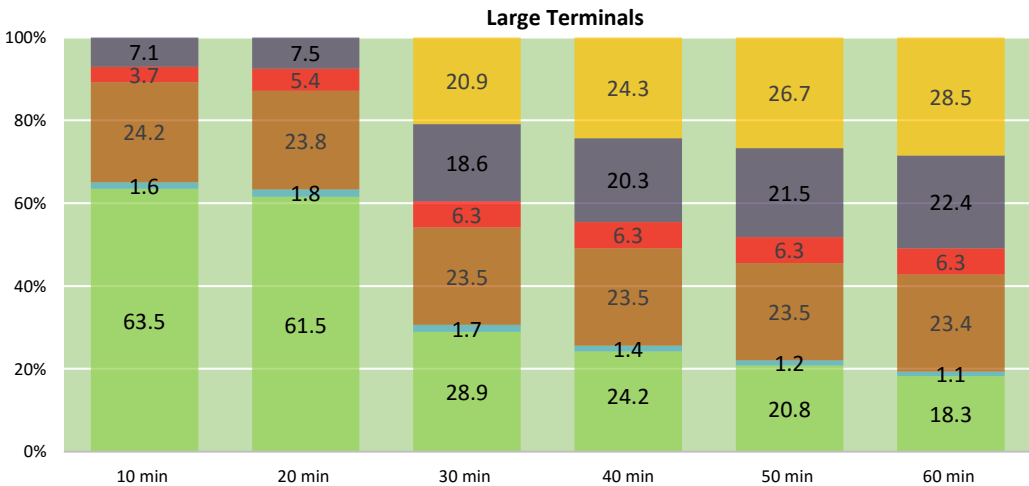
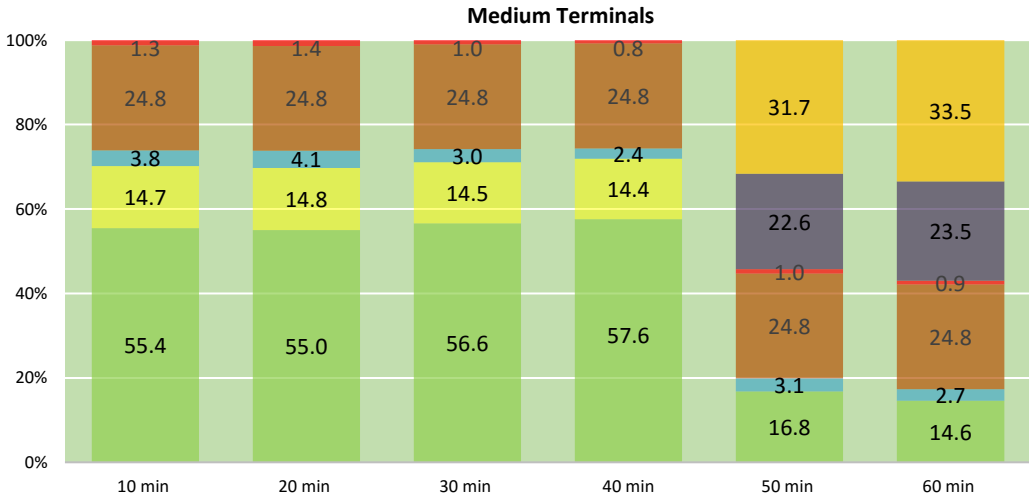
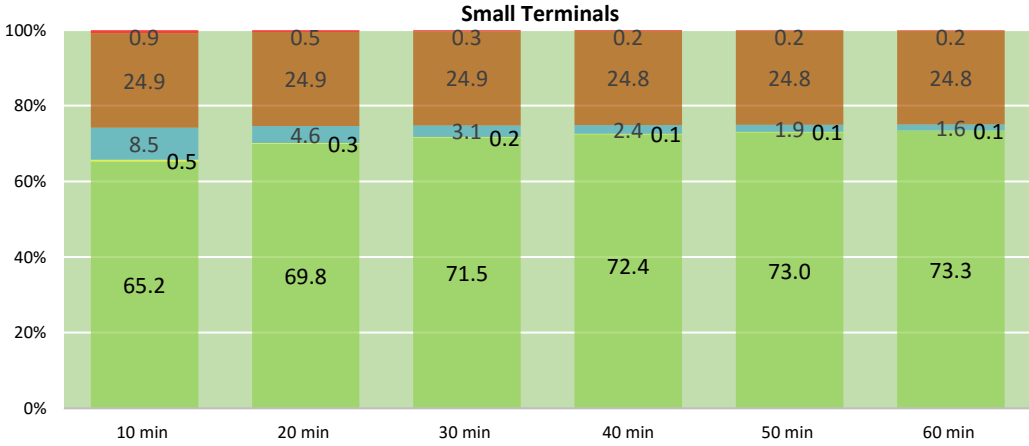

For all terminal sizes, increasing layover time, leads to increasing bus accumulation which leads to increased bus parking area requirement. This results in reduction of percentage of site area under other different functions.

In this scenario, multi level car parking (MLCP) replaces at grade private vehicle parking for 50 to 60 minute layover time in medium terminals, and all layover time in large terminals. This is because for these terminal sizes (layover time) car parking demand exceeds the minimum threshold requirement of 120 for a MLCP.

For layover time 50 to 60 minutes in medium terminal and layover time 30 to 60 minutes in large terminals, idle bus parking demand exceeds the minimum threshold of 130 buses for a multi level bus parking (MLBP) This leads to introduction of MLBP in these conditions, which results in reduced bus and workshop area.

Terminal building footprint (Red), MLCP building footprint (Purple), MLBP building footprint (Yellow), Circulation and Ped. Plaza (Light Green), Feeder parking area (Brown), Bus and Workshop area (Light Blue), Private Vehicle parking (Light Green)

*The values represented here correspond 60 buses per hour for small terminal, 150 buses per hour for medium terminal and 390 buses per hour for large terminals

Scenario -5 : With Real Estate development, Multilevel (Ramp) Car parking and Multilevel (Ramp) Bus parking

Typology	Local	B
Operation	Fixed Route Bay	a

Open Area Distribution

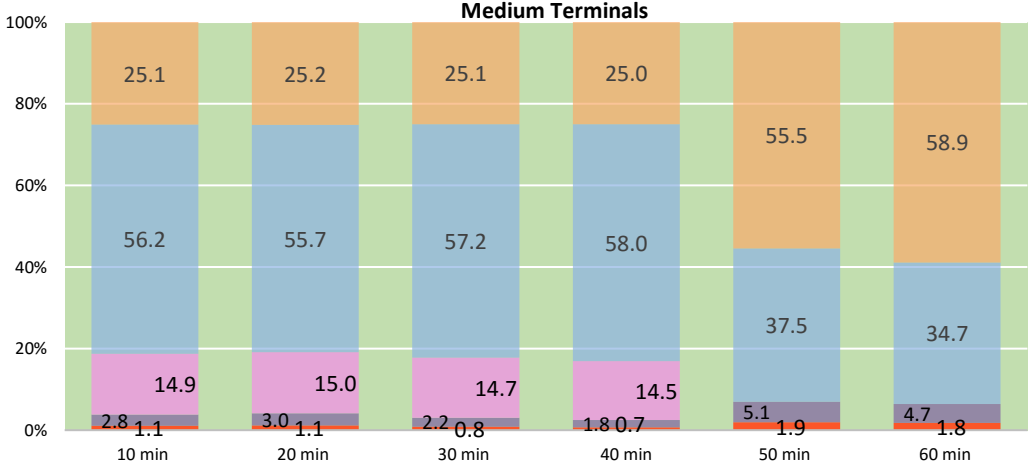
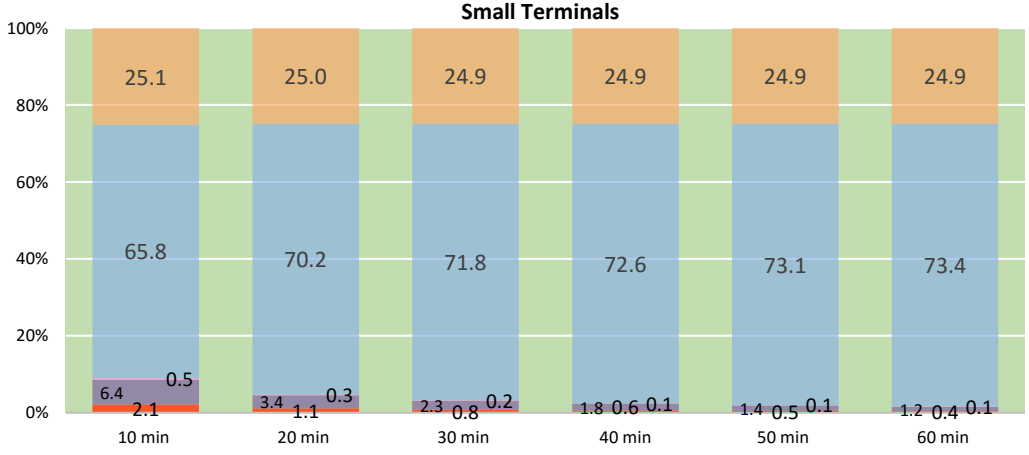

For all terminal sizes, increasing layover time, leads to increasing bus accumulation which leads to increased bus parking area requirement. This results in reduction of percentage of open area under other different functions.

Percentage of open area dedicated to car/private vehicle parking, for 50 to 60 minute layover time in medium terminals and all layover time in large terminals, is '0'. This is because for these terminal sizes (in this scenario) structured car parking is proposed when car parking requirement exceeds 120 ECS.

Similarly percentage of open area dedicated to bus functions (loading, offloading and idle parking) drops significantly for layover time 50 to 60 minute in case of medium terminals and layover time 30 to 60 minutes in case of large terminals. This is because in this scenario idle bus parking is provided in multi level bus parking when the demand for the same exceeds 130.

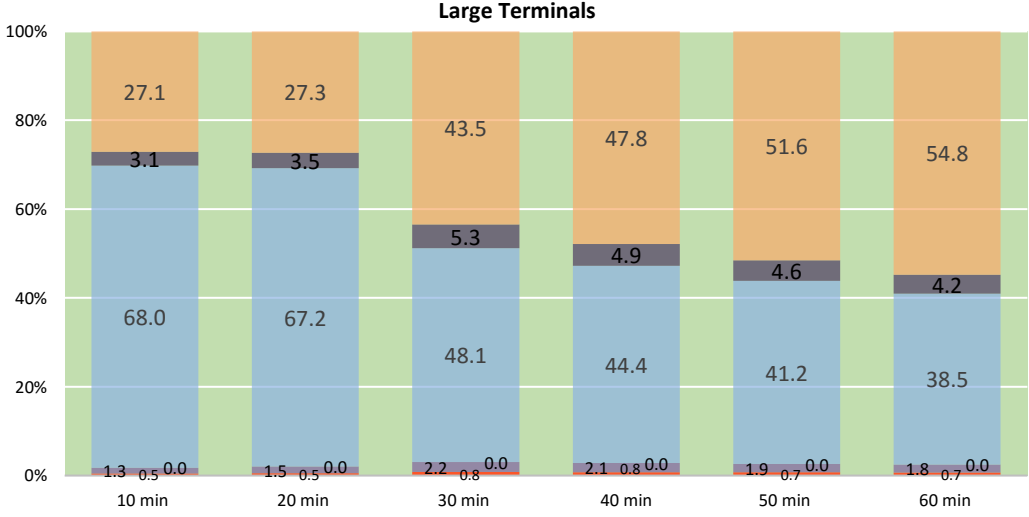

Drop Off (red) Pick up (purple) Car Parking (light purple) Bus Parking (light blue) Circulation area (medium blue) Workshop area (orange) Pedestrian plaza (dark grey) Other (teal)

*The values represented here correspond 60 buses per hour for small terminal, 150 buses per hour for medium terminal and 390 buses per hour for large terminals

Spatial Requirements

Ba

Typology	Local	B
Operation	Fixed Route Bay	a

Scenario -6 : With Real Estate development, Multilevel (Mechanical) Car parking and Multilevel (Ramp) Bus parking

Site Area Distribution

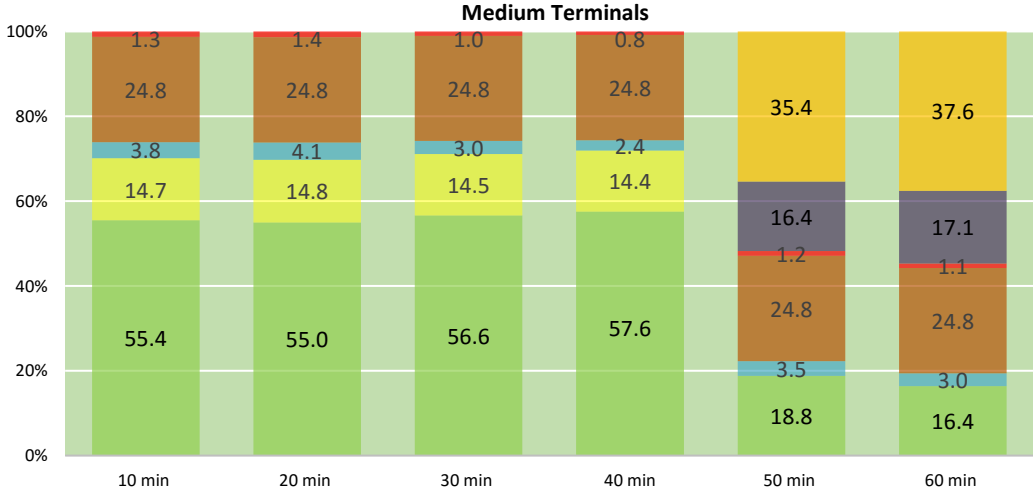
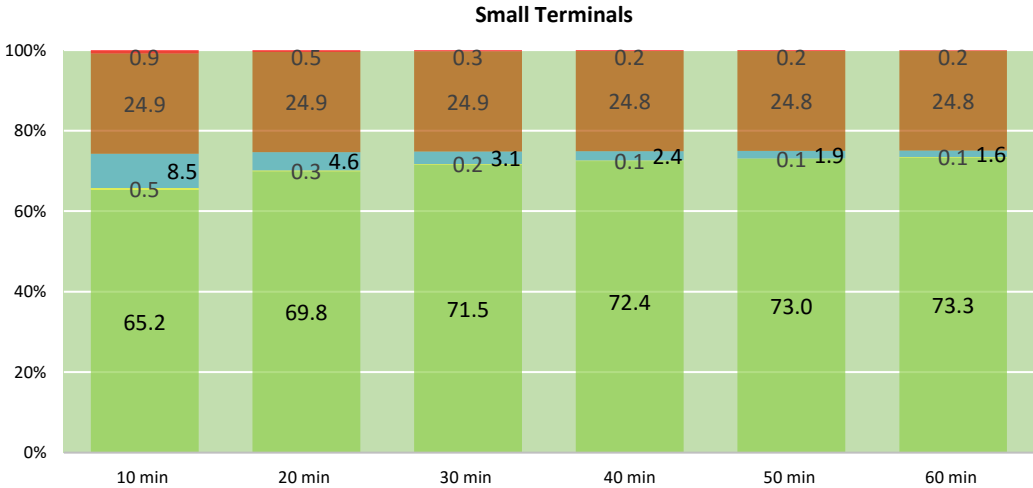

For all terminal sizes, increasing layover time, leads to increasing bus accumulation which leads to increased bus parking area requirement. This results in reduction of percentage of site area under other different functions.

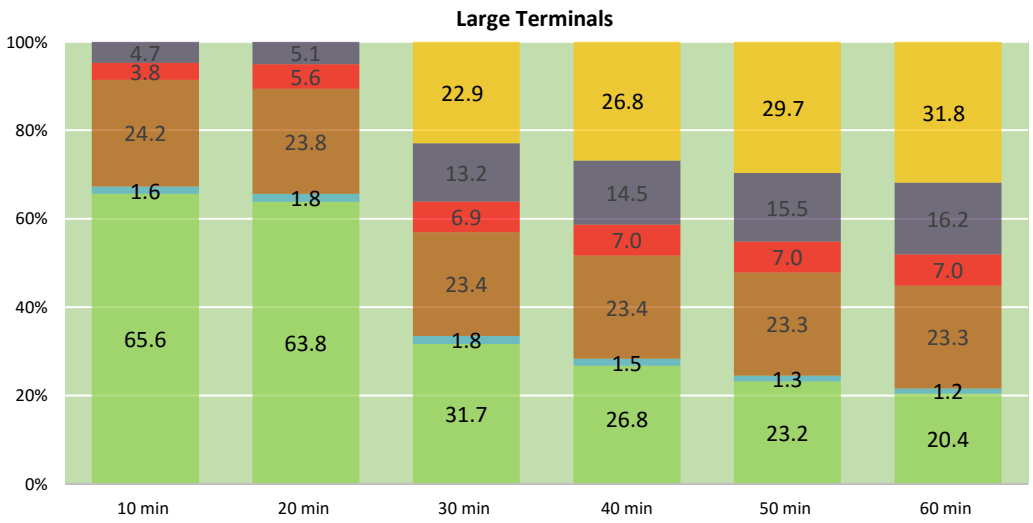

In this scenario, multi level car parking (MLCP) replaces at grade private vehicle parking for 50 to 60 minute layover time in medium terminals, and all layover time in large terminals. This is because for these terminal sizes (layover time) car parking demand exceeds the minimum threshold requirement of 120 for a MLCP.

For layover time 50 to 60 minutes in medium terminal and layover time 30 to 60 minutes in large terminals, idle bus parking demand exceeds the minimum threshold of 130 buses for a multi level bus parking (MLBP) This leads to introduction of MLBP in these conditions, which results in reduced bus and workshop area.

Terminal building footprint (red), MLCP building footprint (purple), MLBP building footprint (yellow), Circulation and Ped. Plaza (orange), Feeder parking area (light blue), Bus and Workshop area (green), Private Vehicle parking (yellow)

*The values represented here correspond 60 buses per hour for small terminal, 150 buses per hour for medium terminal and 390 buses per hour for large terminals

Scenario -6 : With Real Estate development, Multilevel (Mechanical) Car parking and Multilevel (Ramp) Bus parking.

Typology	Local	B
Operation	Fixed Route Bay	a

Open Area Distribution

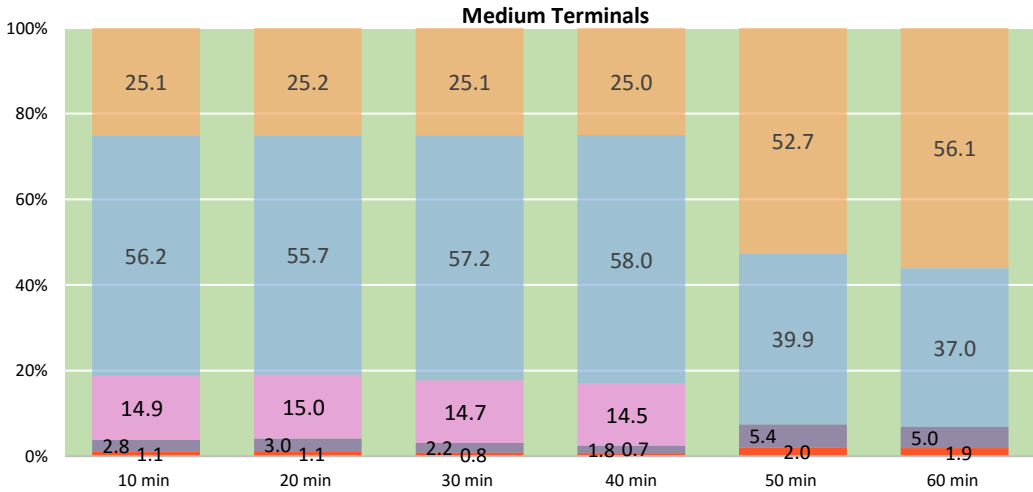
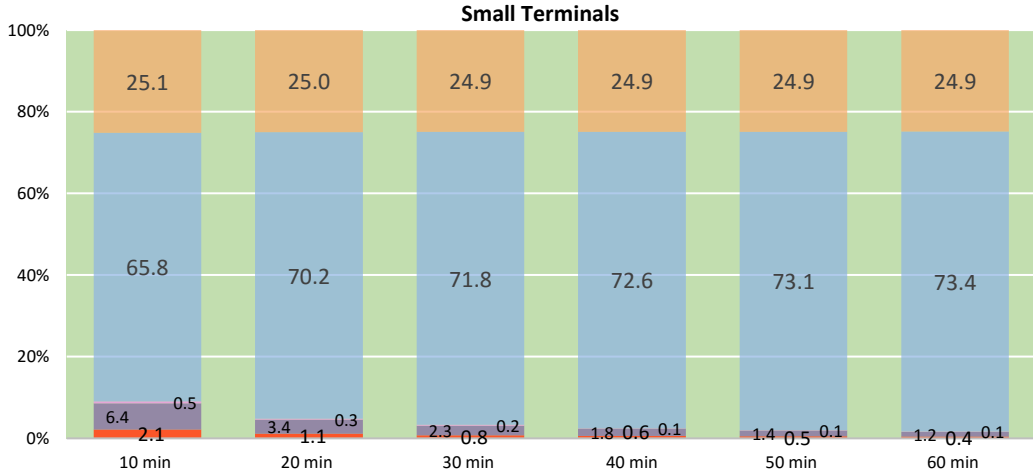

For all terminal sizes, increasing layover time, leads to increasing bus accumulation which leads to increased bus parking area requirement. This results in reduction of percentage of open area under other different functions.

Percentage of open area dedicated to car/private vehicle parking, for 50 to 60 minute layover time in medium terminals and all layover time in large terminals, is '0'. This is because for these terminal sizes (in this scenario) structured car parking is proposed when car parking requirement exceeds 120 ECS.

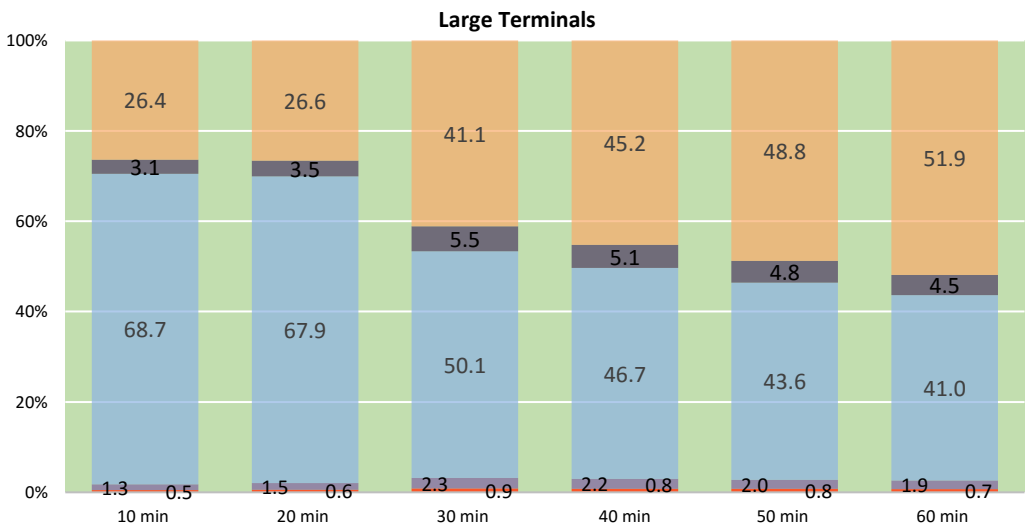

Similarly percentage of open area dedicated to bus functions (loading, offloading and idle parking) drops significantly for layover time 50 to 60 minute in case of medium terminals and layover time 30 to 60 minutes in case of large terminals. This is because in this scenario idle bus parking is provided in multi level bus parking when the demand for the same exceeds 130.

Drop Off (red) Pick up (purple) Car Parking (pink) Bus Parking (light blue) Circulation area (blue) Workshop area (orange) Pedestrian plaza (grey) Pedestrian plaza (green)

*The values represented here correspond 60 buses per hour for small terminal, 150 buses per hour for medium terminal and 390 buses per hour for large terminals

Spatial Requirements

Scenario - 7 : With Real estate Development, Basement Car parking & at grade Bus Parking.

Ba

Typology	Local	B
Operation	Fixed Route Bay	a

Site Area Distribution

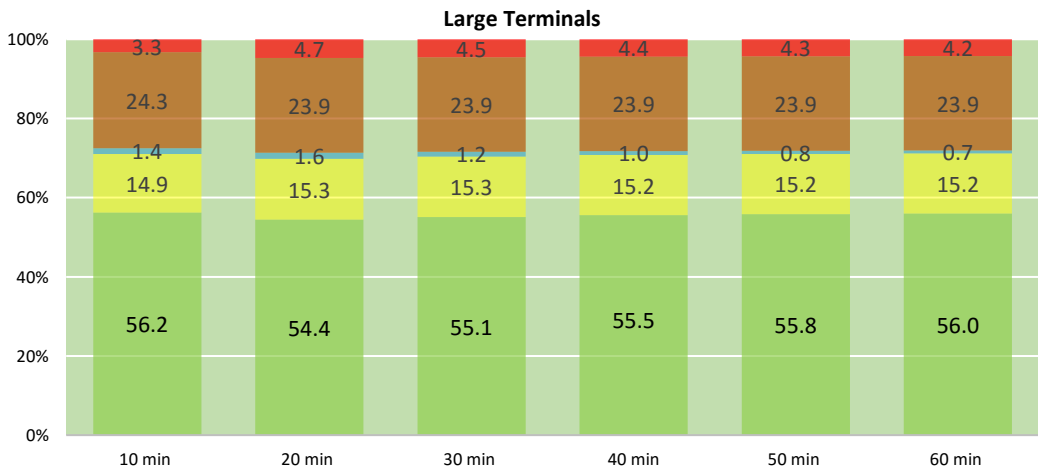
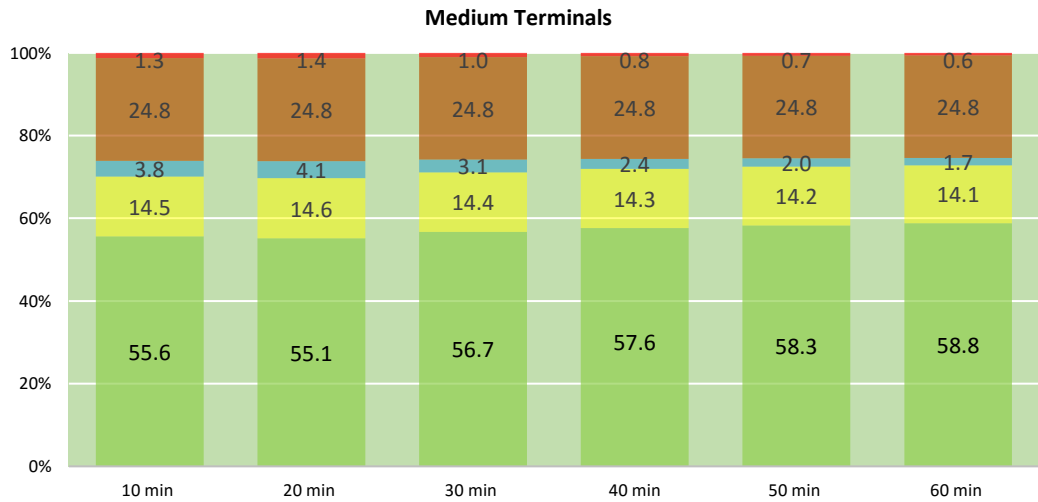
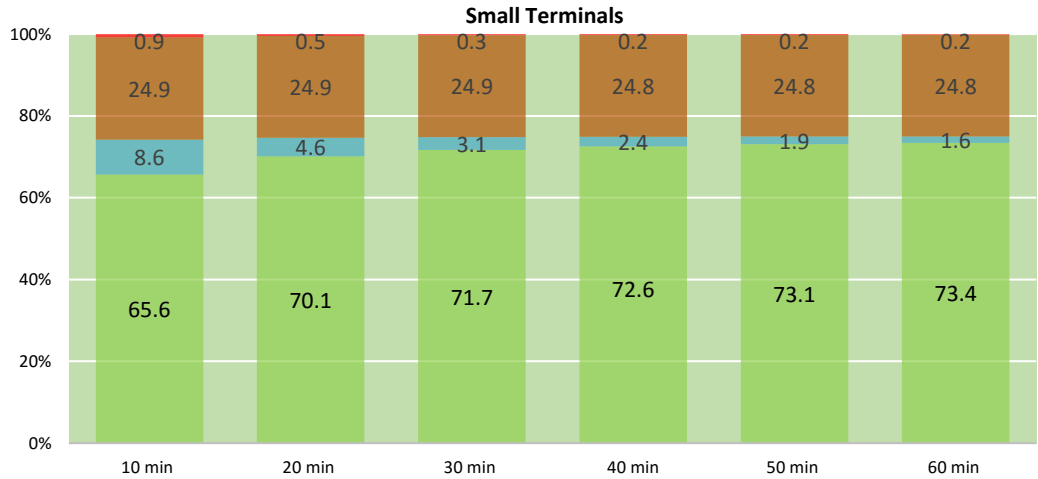

For all terminal sizes, increasing layover time, leads to increasing bus accumulation which leads to increased bus parking area requirement. This results in reduction of percentage of site area under other different functions.

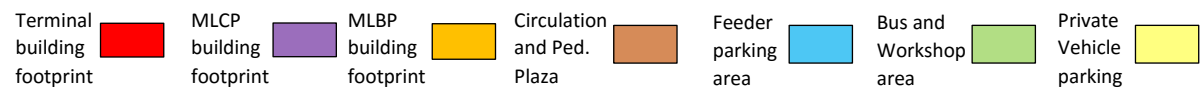

*The values represented here correspond 60 buses per hour for small terminal, 150 buses per hour for medium terminal and 390 buses per hour for large terminals

Scenario - 7 : With Real estate Development, Basement Car parking & at grade Bus Parking.

Typology	Local	B
Operation	Fixed Route Bay	a

Open Area Distribution

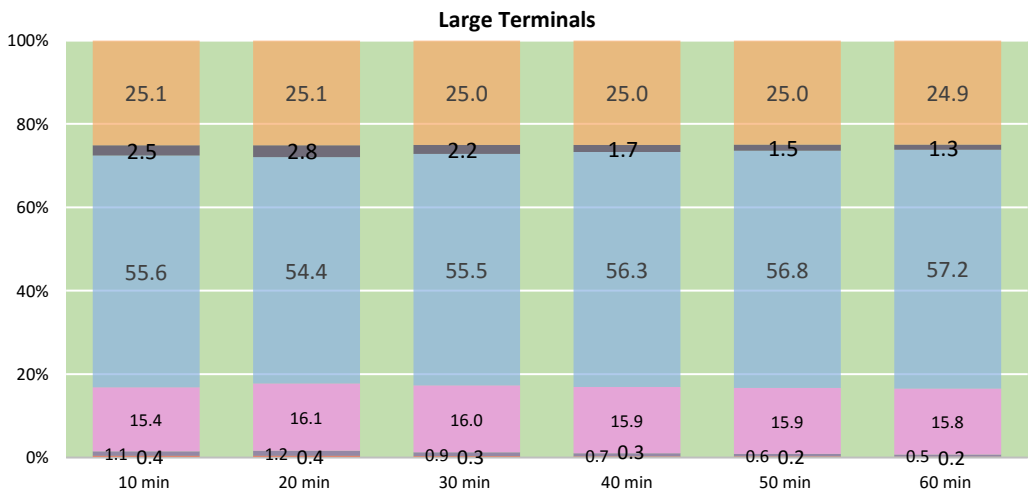
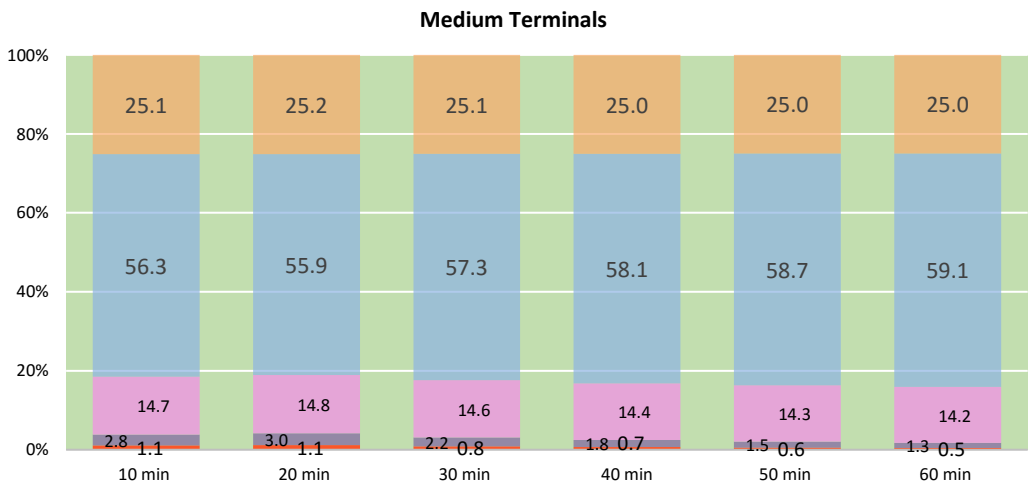
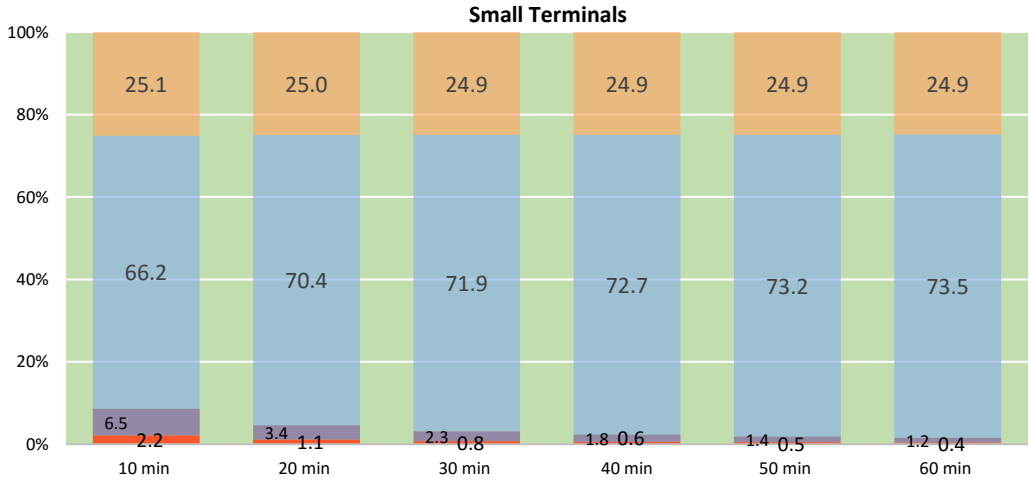

For all terminal sizes, increasing layover time, leads to increasing bus accumulation which leads to increased bus parking area requirement. This results in reduction of percentage of open area under other different functions.

Small terminals have significantly lower area dedicated to car/private vehicle parking as compared to medium and large terminals. This is because car parking requirement surges due to demand for real estate development to offset the cost of medium and large terminal development.

The basement level parking is limited to two floors under the terminal building. This can accommodate only a part of the total parking demand for medium and large terminals.

Drop Off ■ Pick up ■ Car Parking ■ Bus Parking ■ Circulation area ■ Workshop area ■ Pedestrian plaza ■

*The values represented here correspond 60 buses per hour for small terminal, 150 buses per hour for medium terminal and 390 buses per hour for large terminals

Bb

Typology	Local	B
Operation	Dynamic Bay	b

Site Area Distribution

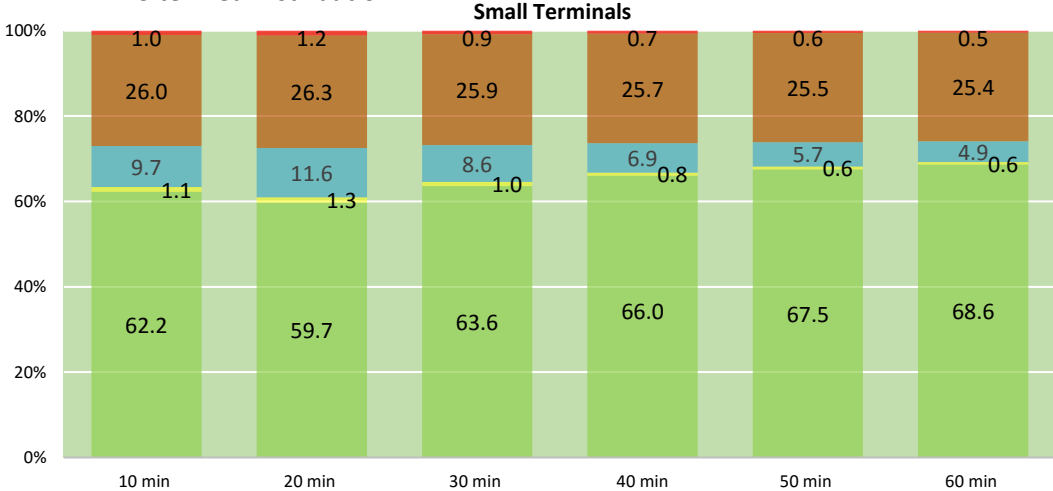

Medium Terminals

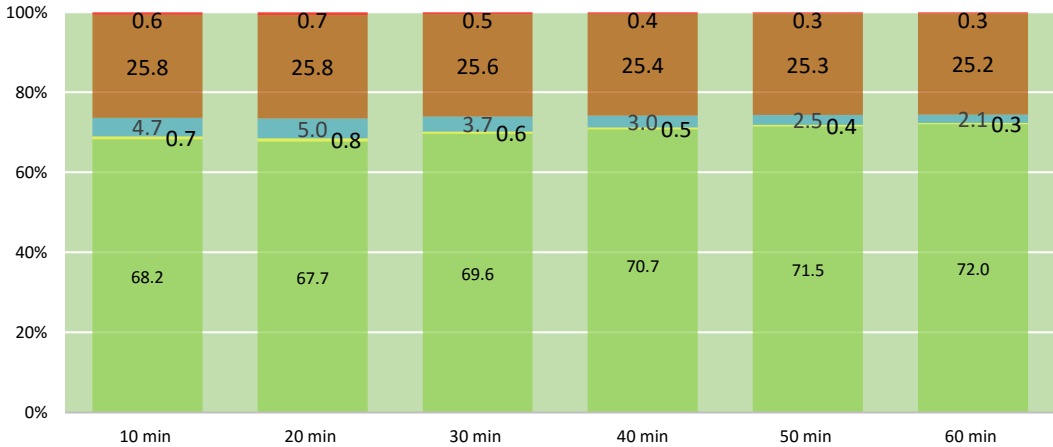

Large Terminals

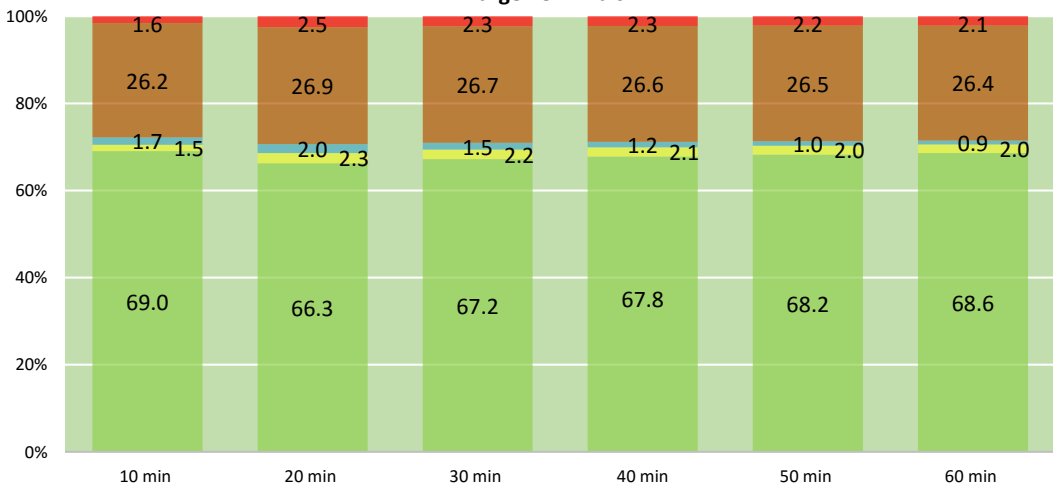

For all terminal sizes, increasing layover time, leads to increasing bus accumulation which leads to increased bus parking area requirement. This results in reduction of percentage of site area under other different functions.

In this scenario, private car parking demand remains minimal as parking demand in local terminal is mainly attributed to commercial/real estate development on the site.

- Terminal building footprint ■
- MLCP building footprint ■
- MLBP building footprint ■
- Circulation and Ped. Plaza ■
- Feeder parking area ■
- Bus and Workshop area ■
- Private Vehicle parking ■

*The values represented here correspond 60 buses per hour for small terminal, 150 buses per hour for medium terminal and 390 buses per hour for large terminals

Scenario -1: Without Real estate Development (No commercial) and at grade car & Bus Parking.

Typology	Local	B
Operation	Dynamic Bay	b

Open Area Distribution

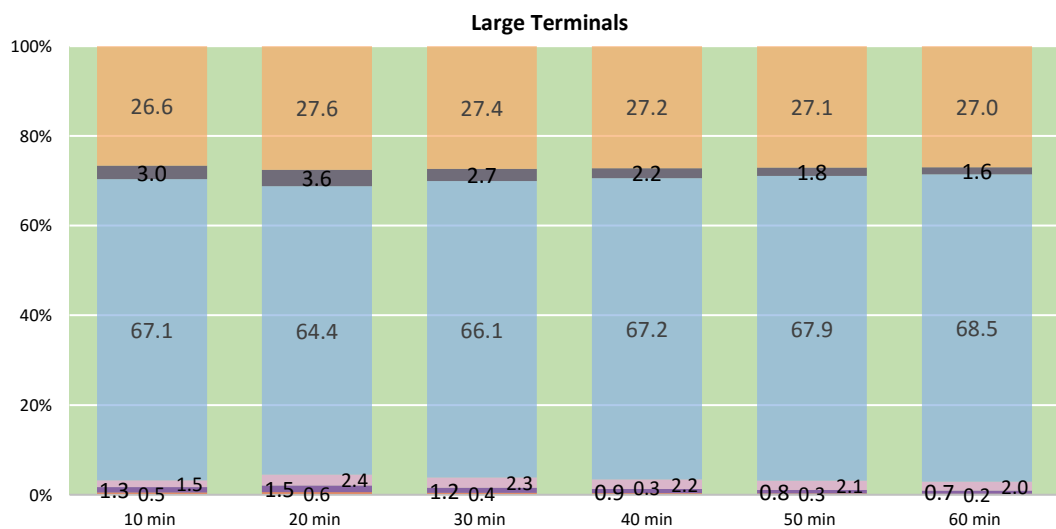
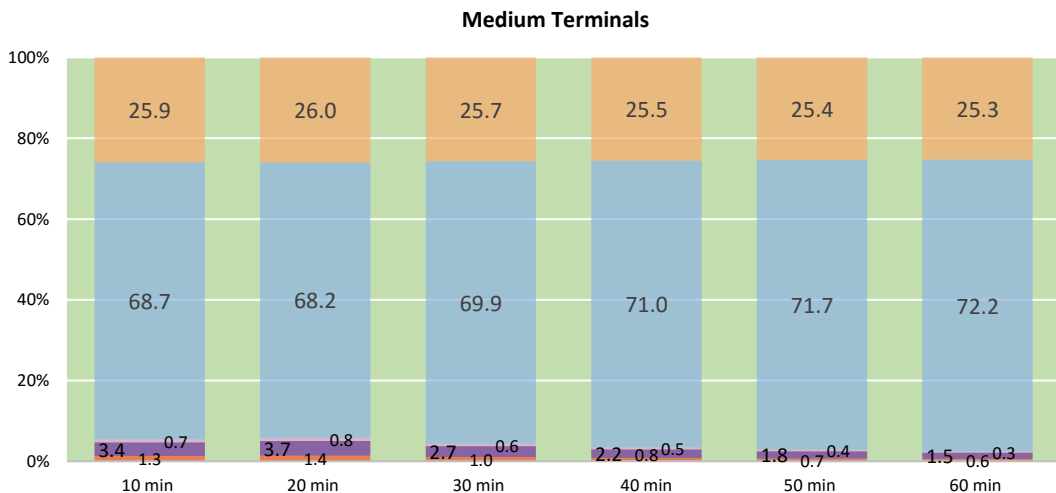
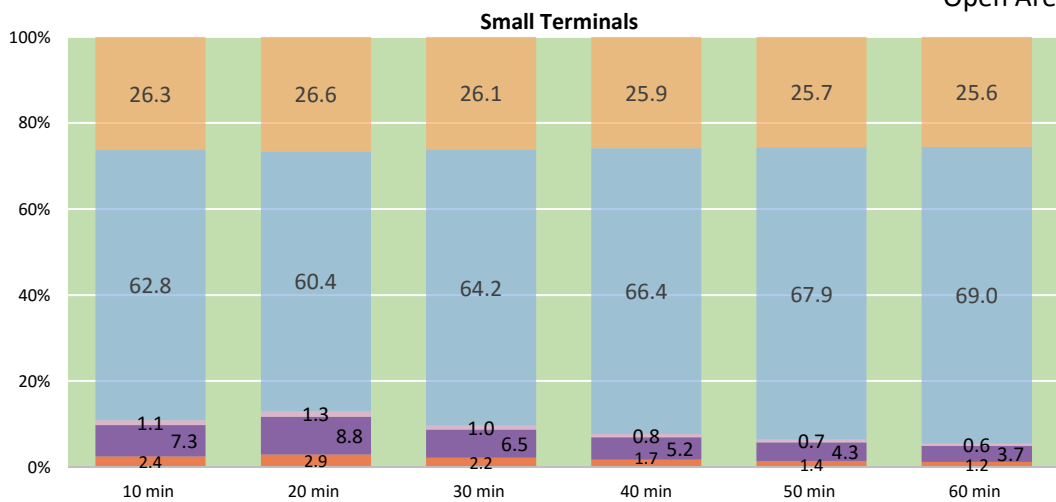

For all terminal sizes, increasing layover time, leads to increasing bus accumulation which leads to increased bus parking area requirement. This results in reduction of percentage of open area under other different functions.

Drop Off (red) Pick up (purple) Car Parking (pink) Bus Parking (light blue) Circulation area (blue) Workshop area (orange) Pedestrian plaza (grey) Open Area (green)

*The values represented here correspond 60 buses per hour for small terminal, 150 buses per hour for medium terminal and 390 buses per hour for large terminals

Spatial Requirements

Scenario 2 : With Real estate Development, at-grade Parking (Car & Bus).

Bb

Typology	Local	B
Operation	Dynamic Bay	b

Site Area Distribution Small Terminals

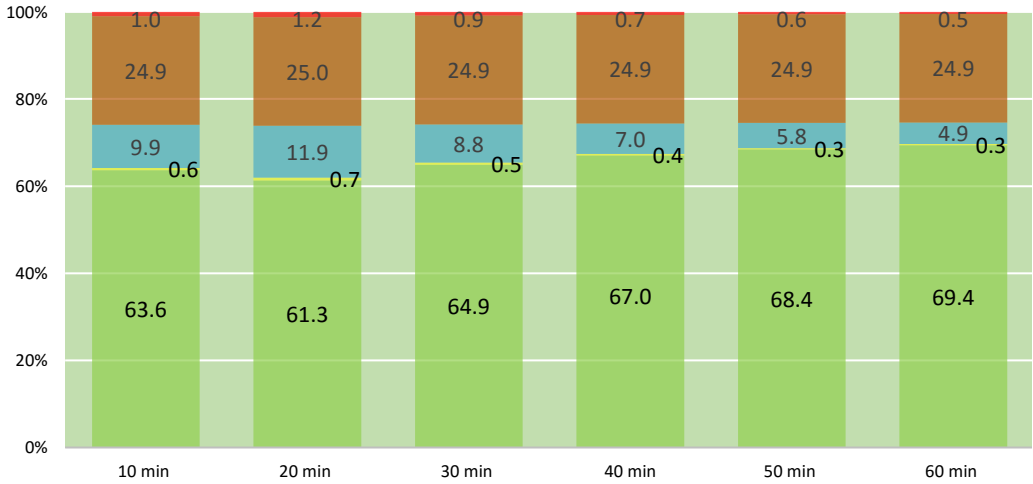

Medium Terminals

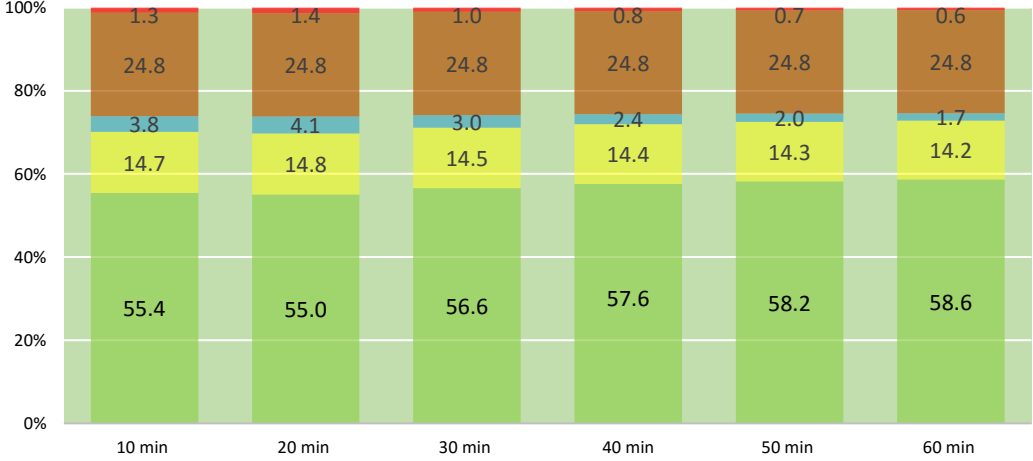

Large Terminals

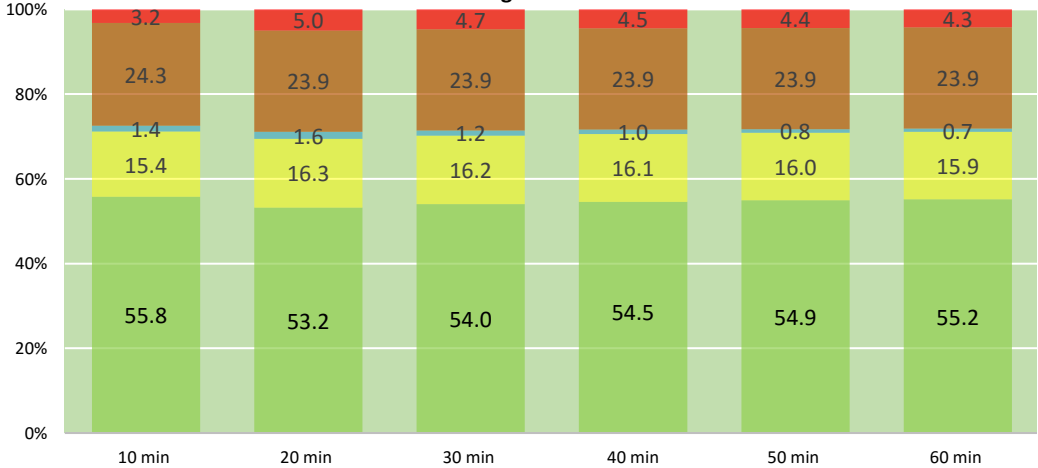

For all terminal sizes, increasing layover time, leads to increasing bus accumulation which leads to increased bus parking area requirement. This results in reduction in percentage of site area under other different functions.

Percentage of car/private vehicle parking area increases significantly for large and medium bus terminals, over small terminals. This is to accommodate increased demand from commercial/real estate development, taken up for these terminal sizes in order to offset the cost of infrastructure development.

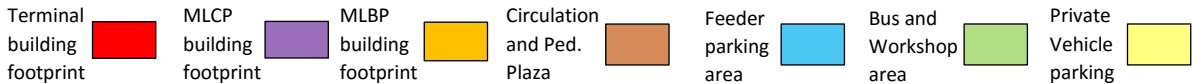

*The values represented here correspond 60 buses per hour for small terminal, 150 buses per hour for medium terminal and 390 buses per hour for large terminals

Scenario 2 : With Real estate Development, at-grade Parking (Car & Bus).

Typology	Local	B
Operation	Dynamic Bay	b

Open Area Distribution

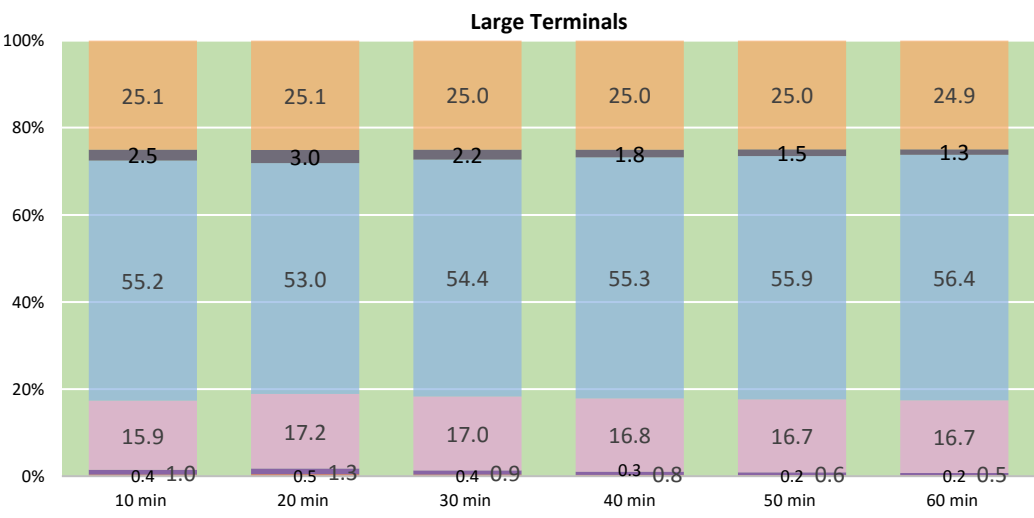
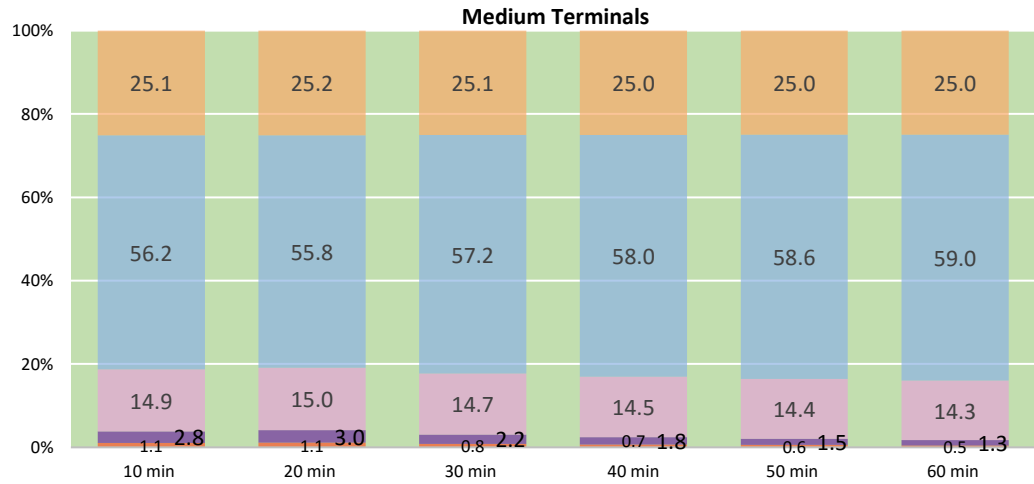
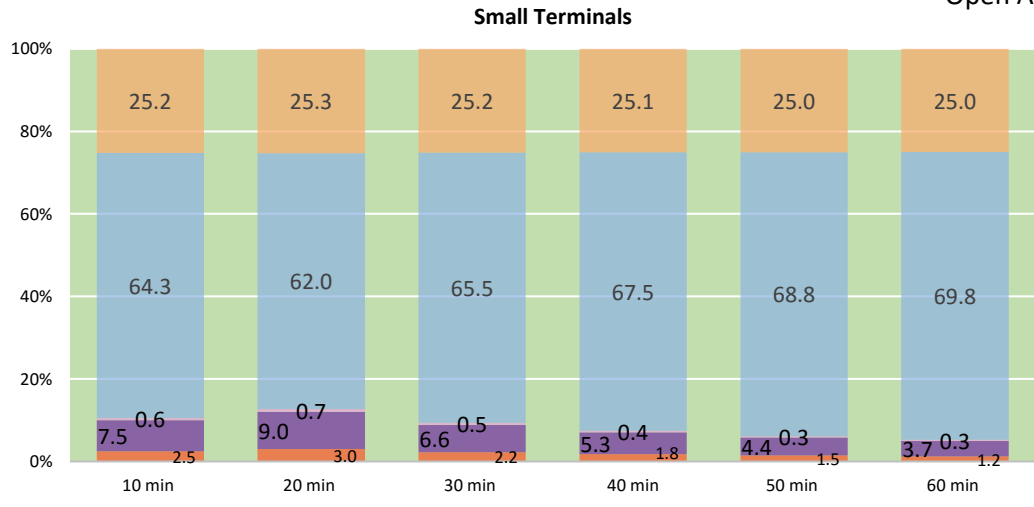

For all terminal sizes, increasing layover time, leads to increasing bus accumulation which leads to increased bus parking area requirement. This results in reduction of percentage of open area under other different functions.

Small terminals have significantly lower area dedicated to car/private vehicle parking as compared to medium and large terminals. This is because car parking requirement surges due to demand for real estate development to offset the cost of medium and large terminal development.

Drop Off ■ Pick up ■ Car Parking ■ Bus Parking ■ Circulation area ■ Workshop area ■ Pedestrian plaza ■

*The values represented here correspond 60 buses per hour for small terminal, 150 buses per hour for medium terminal and 390 buses per hour for large terminals

Spatial Requirements

Bb

Scenario -3 : With Real Estate development, Multilevel (Ramp) Car and (At grade) Bus parking.

Typology	Local	B
Operation	Dynamic Bay	b

Site Area Distribution

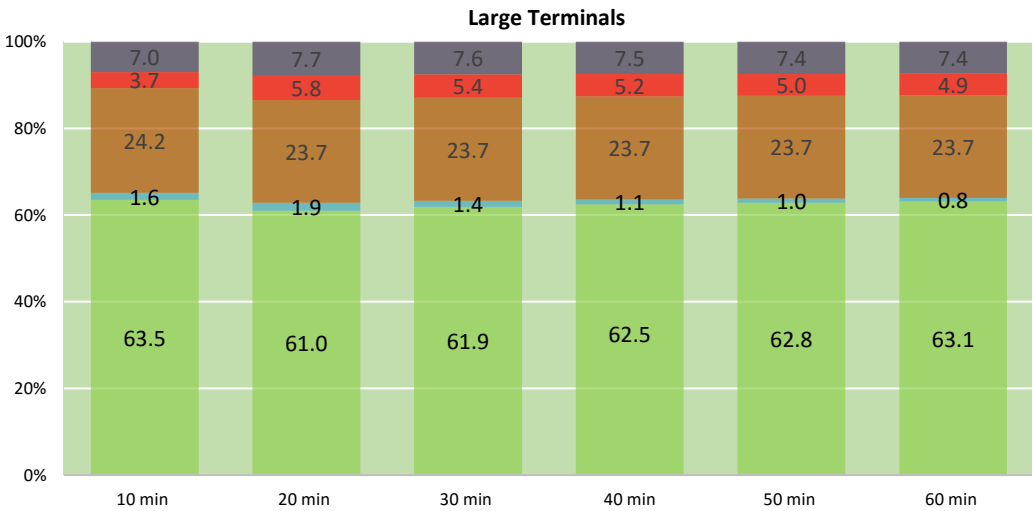
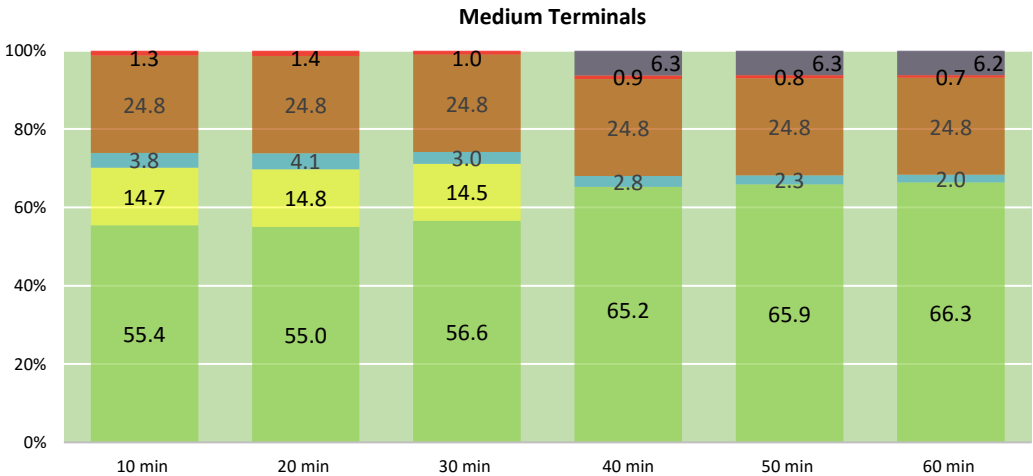
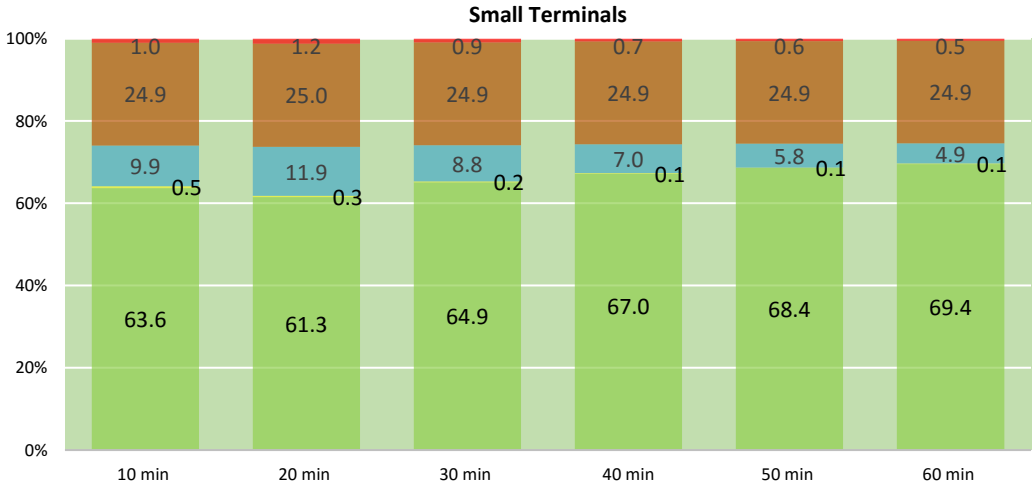

For all terminal sizes, increasing layover time, leads to increasing bus accumulation which leads to increased bus parking area requirement. This results in reduction of percentage of site area under other different functions.

In this scenario, multi level car parking (MLCP) replaces at grade private vehicle parking in medium terminals with layover time 40 to 60 minutes and large terminals for all layover time. This is because for these terminal sizes car parking demand exceeds the minimum threshold requirement of 120 for a MLCP.

Terminal building footprint (Red), MLCP building footprint (Purple), MLBP building footprint (Blue), Circulation and Ped. Plaza (Yellow), Feeder parking area (Orange), Bus and Workshop area (Light Blue), Private Vehicle parking (Green)

*The values represented here correspond 60 buses per hour for small terminal, 150 buses per hour for medium terminal and 390 buses per hour for large terminals

Scenario -3 : With Real Estate development, Multilevel (Ramp) Car and (At grade) Bus parking.

Typology	Local	B
Operation	Dynamic Bay	b

Open Area Distribution

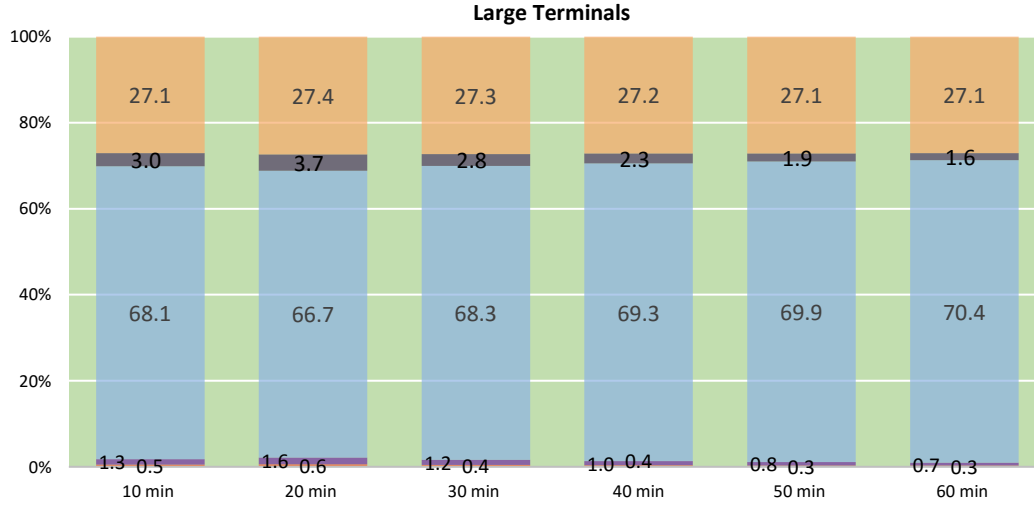
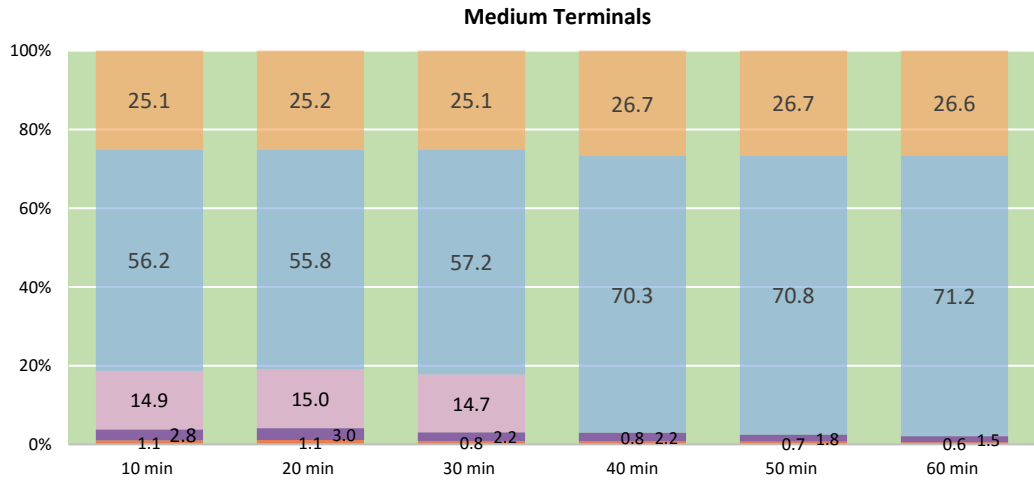
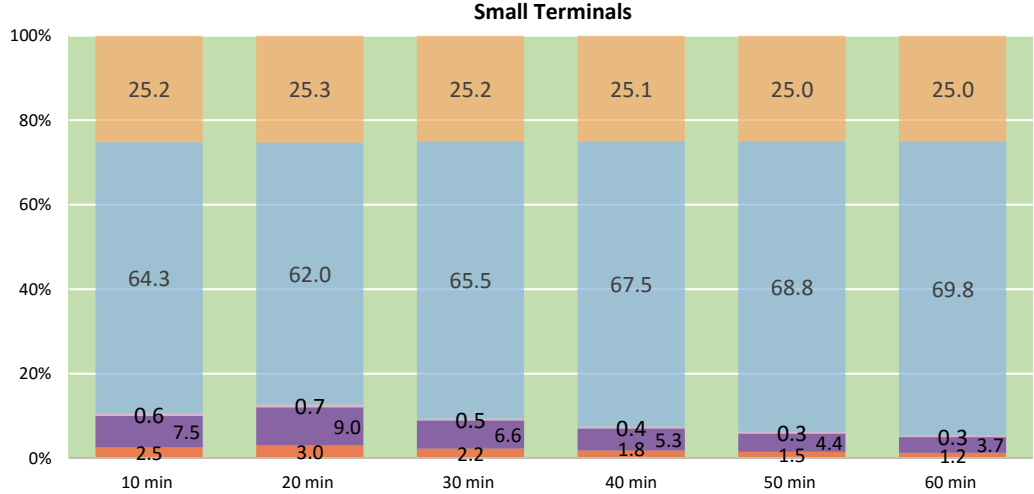

For all terminal sizes, increasing layover time, leads to increasing bus accumulation which leads to increased bus parking area requirement. This results in reduction of percentage of open area under other different functions.

Percentage of open area dedicated to car/private vehicle parking, for 40 to 60 minute layover time in medium terminals and all layover time in large terminals, is '0'. This is because for these terminal sizes (in this scenario) structured car parking is proposed when car parking requirement exceeds 120 ECS.

Drop Off (Red) Pick up (Purple) Car Parking (Light Purple) Bus Parking (Light Blue) Circulation area (Blue) Workshop area (Orange) Pedestrian plaza (Dark Blue) (Dark Green)

*The values represented here correspond 60 buses per hour for small terminal, 150 buses per hour for medium terminal and 390 buses per hour for large terminals

Spatial Requirements

Scenario -4 : With Real Estate development, Multilevel (Mechanical) Car parking and (At grade) Bus parking.

Bb

Typology	Local	B
Operation	Dynamic Bay	b

Site Area Distribution

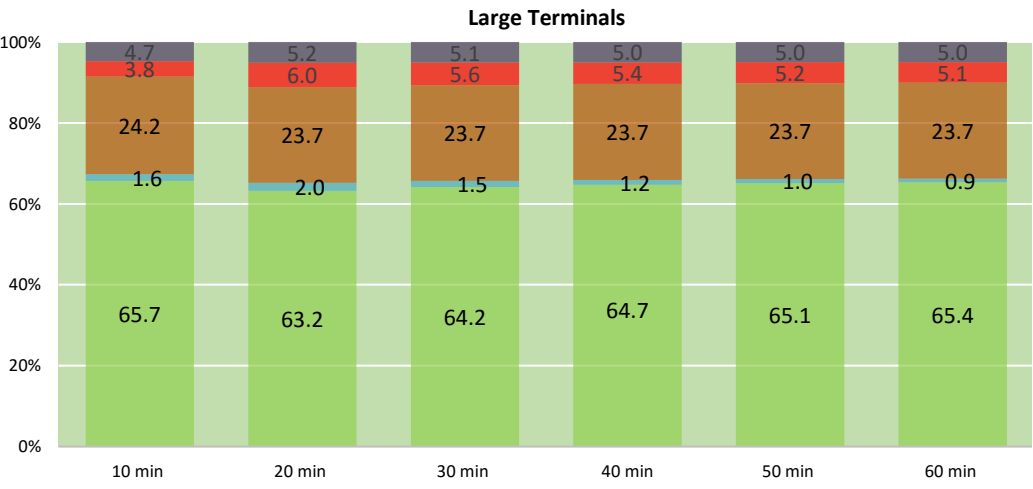
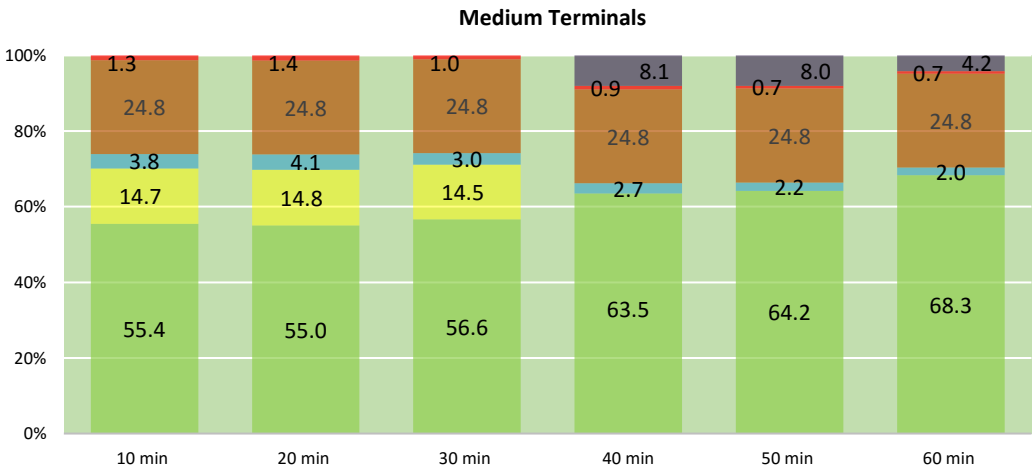
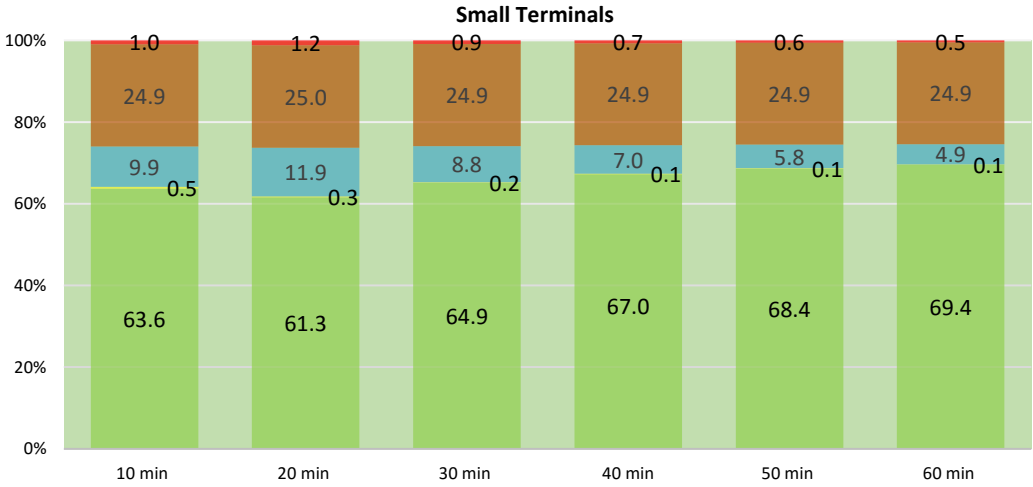

For all terminal sizes, increasing layover time, leads to increasing bus accumulation which leads to increased bus parking area requirement. This results in reduction of percentage of site area under other different functions.

In this scenario, multi level car parking (MLCP) replaces at grade private vehicle parking in medium terminals and large terminals for all layover time. This is because for these terminal sizes car parking demand exceeds the minimum threshold requirement of 120 for a MLCP.

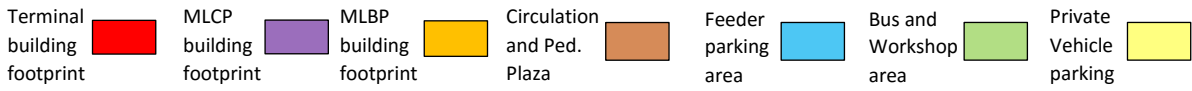

*The values represented here correspond 60 buses per hour for small terminal, 150 buses per hour for medium terminal and 390 buses per hour for large terminals

Scenario -4 : With Real Estate development, Multilevel (Mechanical) Car parking and (At grade) Bus parking.

Typology	Local	B
Operation	Dynamic Bay	b

Open Area Distribution

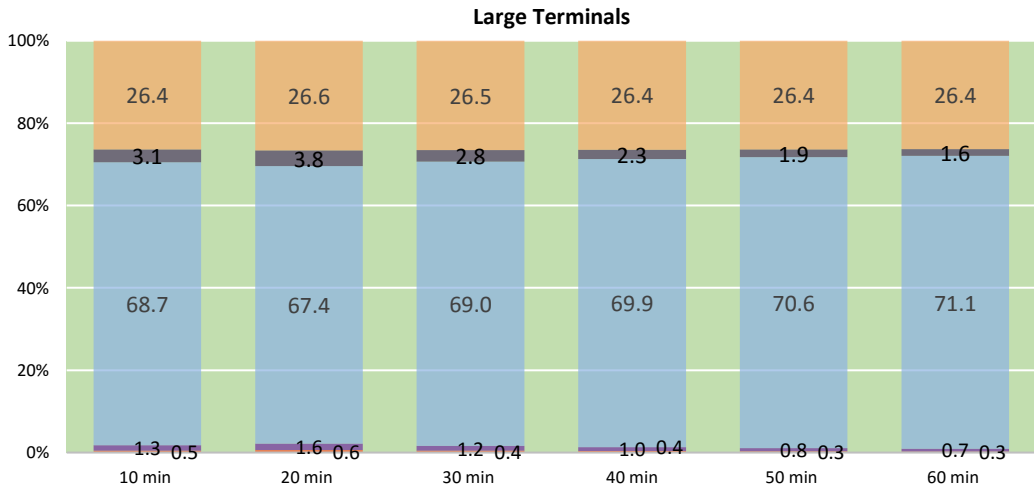
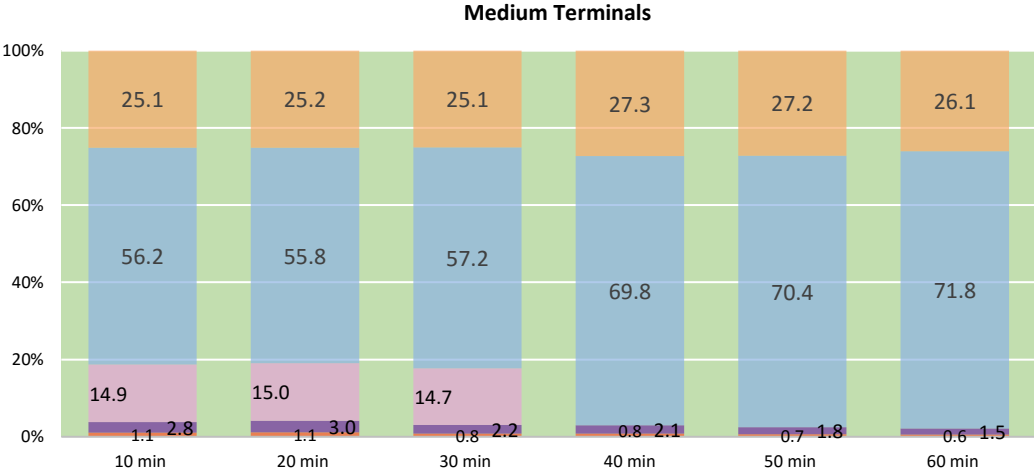
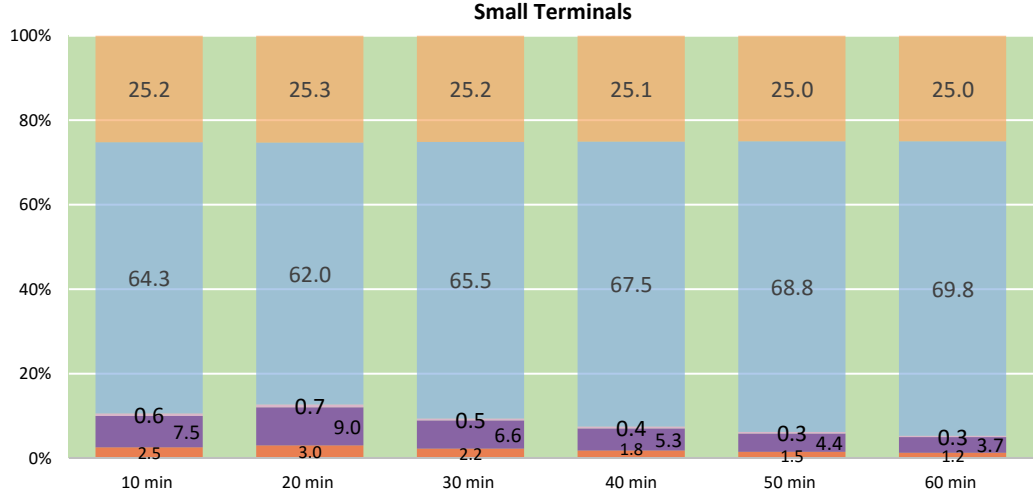

For all terminal sizes, increasing layover time, leads to increasing bus accumulation which leads to increased bus parking area requirement. This results in reduction of percentage of open area under other different functions.

Percentage of open area dedicated to car/private vehicle parking, for 40 to 60 minute layover time in medium terminals and all layover time in large terminals, is '0'. This is because for these terminal sizes (in this scenario) structured car parking is proposed when car parking requirement exceeds 120 ECS.

Drop Off ■ Pick up ■ Car Parking ■ Bus Parking ■ Circulation area ■ Workshop area ■ Pedestrian plaza ■

*The values represented here correspond 60 buses per hour for small terminal, 150 buses per hour for medium terminal and 390 buses per hour for large terminals

Spatial Requirements

Bb

Typology	Local	B
Operation	Dynamic Bay	b

Scenario -5 : With Real Estate development, Multilevel (Ramp) Car parking and Multilevel (Ramp) Bus parking

Site Area Distribution

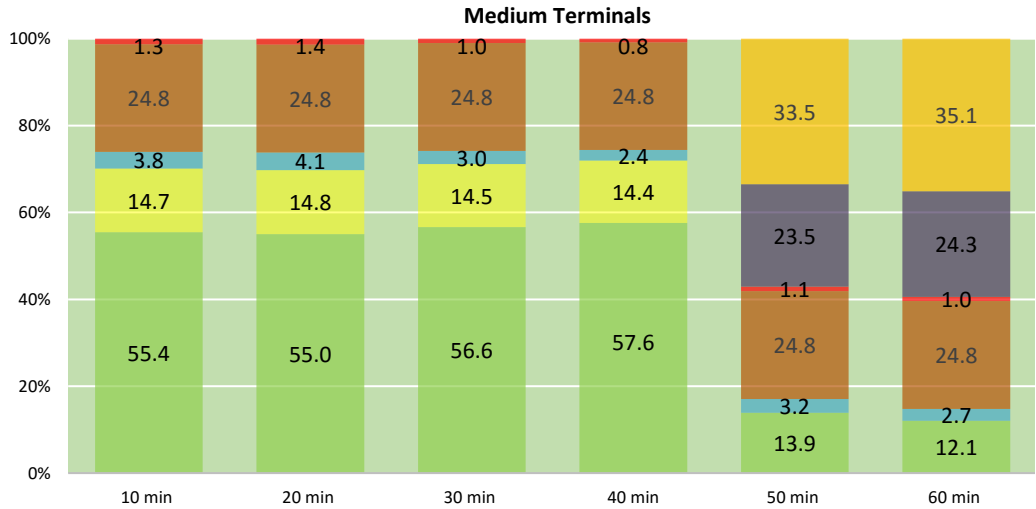
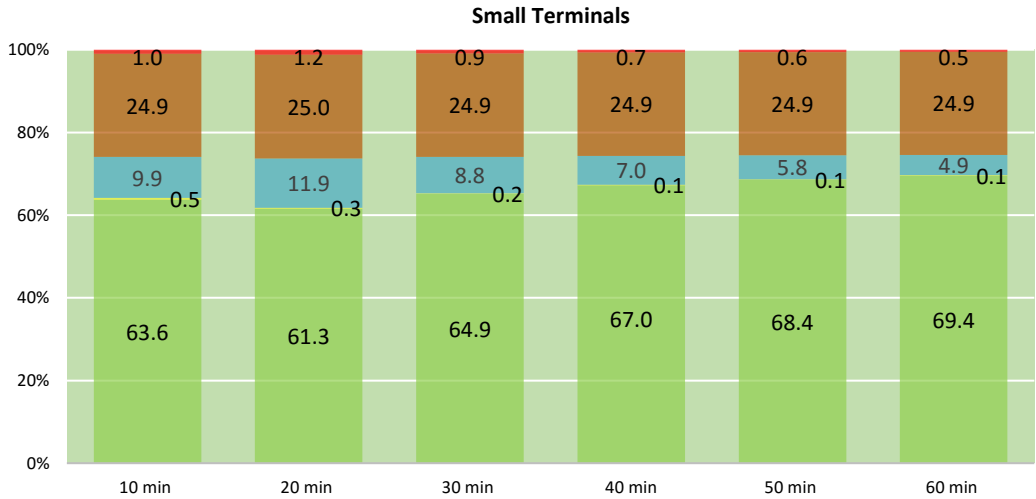

For all terminal sizes, increasing layover time, leads to increasing bus accumulation which leads to increased bus parking area requirement. This results in reduction of percentage of site area under other different functions.

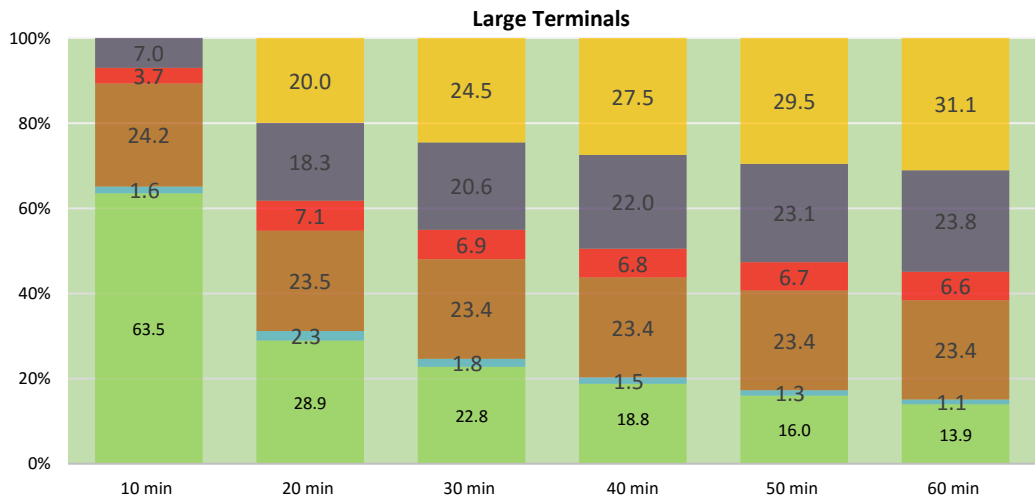

In this scenario, multi level car parking (MLCP) replaces at grade private vehicle parking for 50 to 60 minute layover time in medium terminals, and all layover time in large terminals. This is because for these terminal sizes (layover time) car parking demand exceeds the minimum threshold requirement of 120 for a MLCP.

For layover time 50 to 60 minutes in medium terminal and layover time 20 to 60 minutes in large terminals, idle bus parking demand exceeds the minimum threshold of 130 buses for a multi level bus parking (MLBP) This leads to introduction of MLBP in these conditions, which results in reduced bus and workshop area.

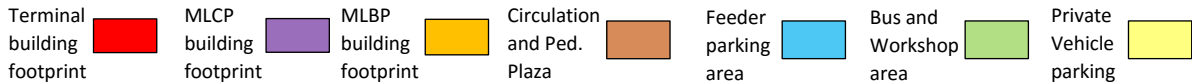

*The values represented here correspond 60 buses per hour for small terminal, 150 buses per hour for medium terminal and 390 buses per hour for large terminals

Scenario -5 : With Real Estate development, Multilevel (Ramp) Car parking and Multilevel (Ramp) Bus parking

Typology	Local	B
Operation	Dynamic Bay	b

Open Area Distribution

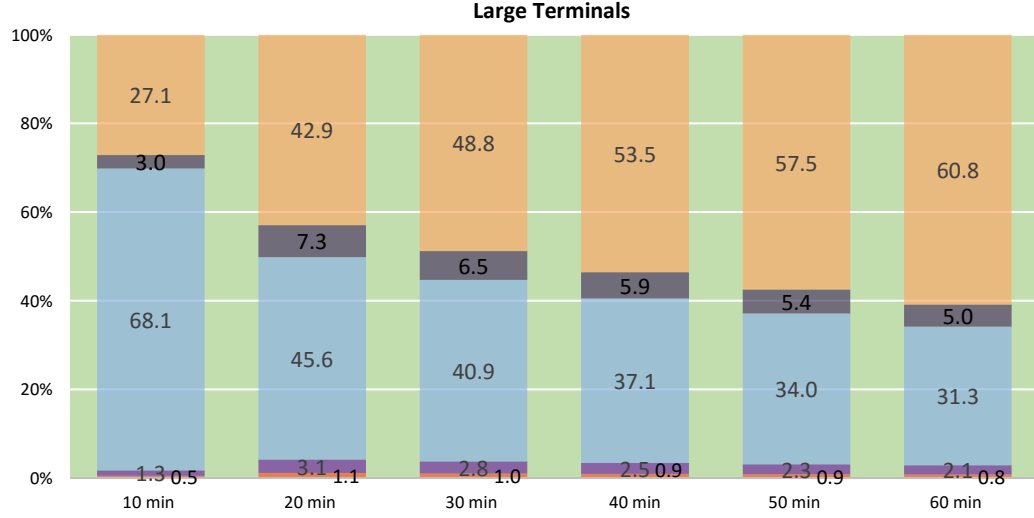
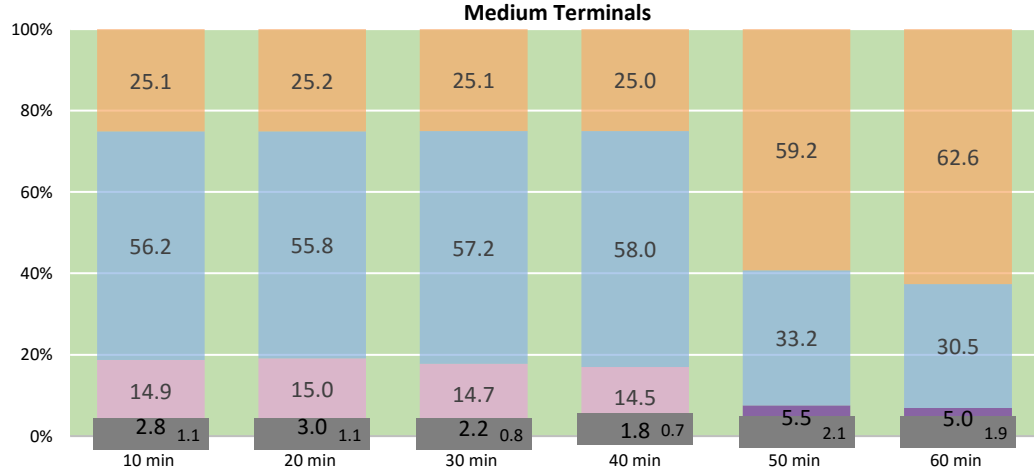
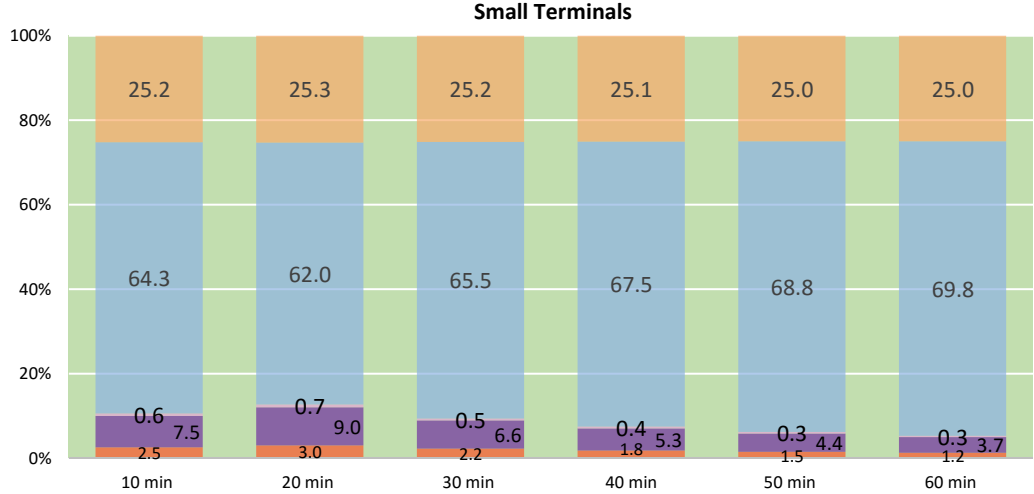

For all terminal sizes, increasing layover time, leads to increasing bus accumulation which leads to increased bus parking area requirement. This results in reduction of percentage of open area under other different functions.

Percentage of open area dedicated to car/private vehicle parking, for 50 to 60 minute layover time in medium terminals and all layover time in large terminals, is '0'. This is because for these terminal sizes (in this scenario) structured car parking is proposed when car parking requirement exceeds 120 ECS.

Similarly percentage of open area dedicated to bus functions (loading, offloading and idle parking) drops significantly for layover time 50 to 60 minute in case of medium terminals and layover time 20 to 60 minutes in case of large terminals. This is because in this scenario idle bus parking is provided in multi level bus parking when the demand for the same exceeds 130.

Drop Off ■ Pick up ■ Car Parking ■ Bus Parking ■ Circulation area ■ Workshop area ■ Pedestrian plaza ■

*The values represented here correspond 60 buses per hour for small terminal, 150 buses per hour for medium terminal and 390 buses per hour for large terminals

Spatial Requirements

Bb

Typology	Local	B
Operation	Dynamic Bay	b

Scenario - 6 : With Real Estate development, Multilevel (Mechanical) Car parking and Multilevel (Ramp) Bus parking

Site Area Distribution

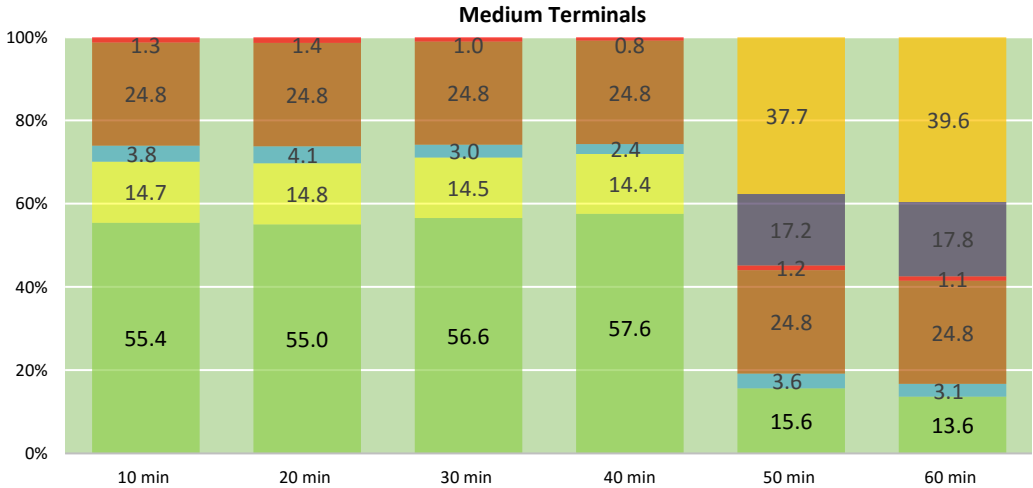
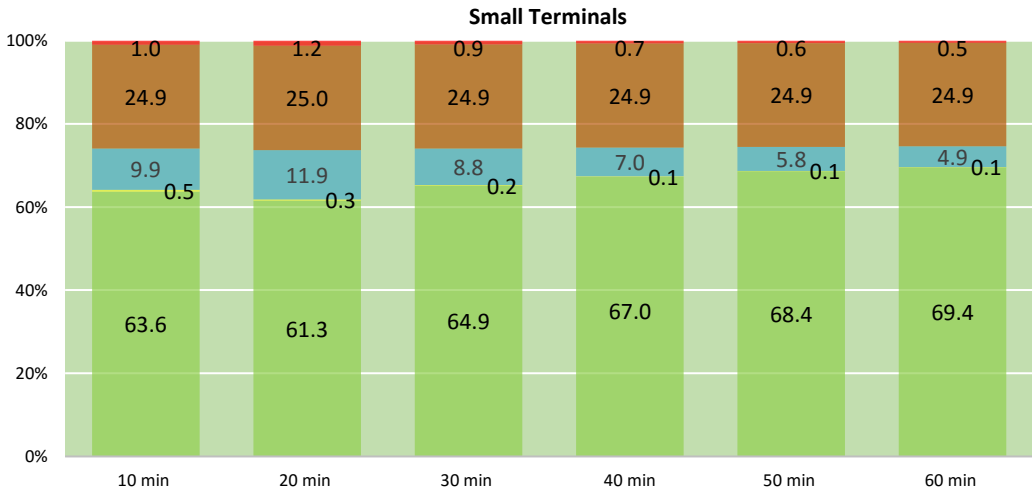

For all terminal sizes, increasing layover time, leads to increasing bus accumulation which leads to increased bus parking area requirement. This results in reduction of percentage of site area under other different functions.

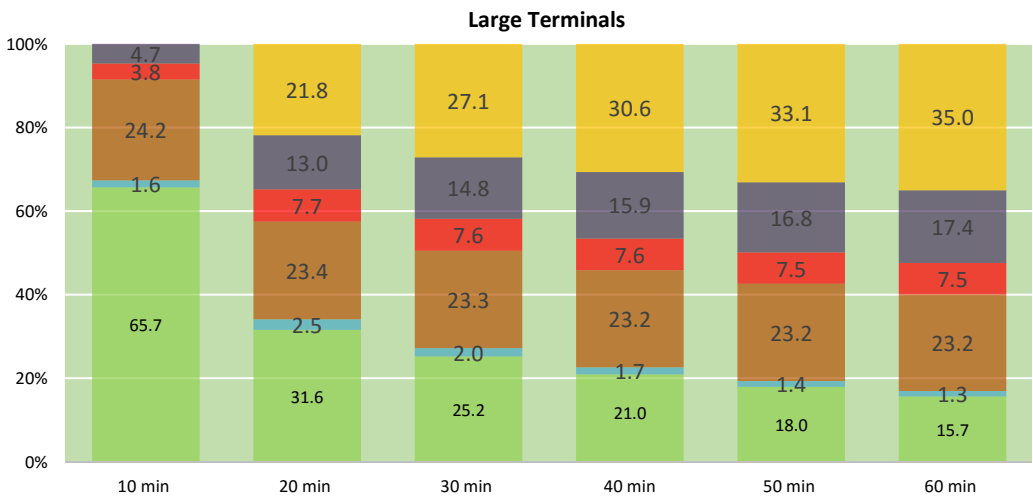

In this scenario, multi level car parking (MLCP) replaces at grade private vehicle parking for 50 to 60 minute layover time in medium terminals, and all layover time in large terminals. This is because for these terminal sizes (layover time) car parking demand exceeds the minimum threshold requirement of 120 for a MLCP.

For layover time 50 to 60 minutes in medium terminal and layover time 30 to 60 minutes in large terminals, idle bus parking demand exceeds the minimum threshold of 130 buses for a multi level bus parking (MLBP) This leads to introduction of MLBP in these conditions, which results in reduced bus and workshop area.

Terminal building footprint (brown), MLCP building footprint (red), MLBP building footprint (purple), Circulation and Ped. Plaza (blue), Feeder parking area (orange), Bus and Workshop area (light green), Private Vehicle parking (green)

*The values represented here correspond 60 buses per hour for small terminal, 150 buses per hour for medium terminal and 390 buses per hour for large terminals

Scenario - 6 : With Real Estate development, Multilevel (Mechanical) Car parking and Multilevel (Ramp) Bus parking

Typology	Local	B
Operation	Dynamic Bay	b

Open Area Distribution



For all terminal sizes, increasing layover time, leads to increasing bus accumulation which leads to increased bus parking area requirement. This results in reduction of percentage of open area under other different functions.

Percentage of open area dedicated to car/private vehicle parking, for 50 to 60 minute layover time in medium terminals and all layover time in large terminals, is '0'. This is because for these terminal sizes (in this scenario) structured car parking is proposed when car parking requirement exceeds 120 ECS.

Similarly percentage of open area dedicated to bus functions (loading, offloading and idle parking) drops significantly for layover time 50 to 60 minute in case of medium terminals and layover time 30 to 60 minutes in case of large terminals. This is because in this scenario idle bus parking is provided in multi level bus parking when the demand for the same exceeds 130.



*The values represented here correspond 60 buses per hour for small terminal, 150 buses per hour for medium terminal and 390 buses per hour for large terminals

Spatial Requirements

Bb

Scenario - 7 : With Real estate Development, Basement Car parking & at grade Bus Parking.

Typology	Local	B
Operation	Dynamic Bay	b

Site Area Distribution

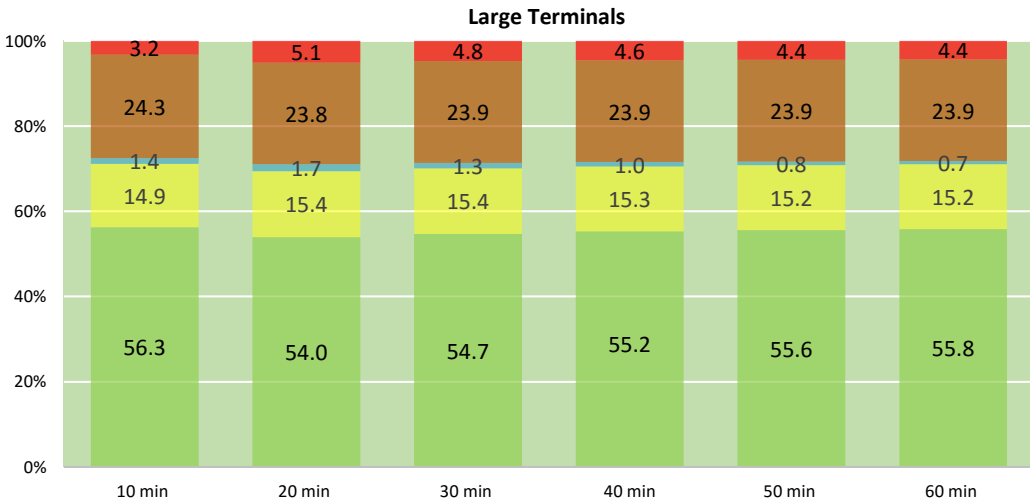
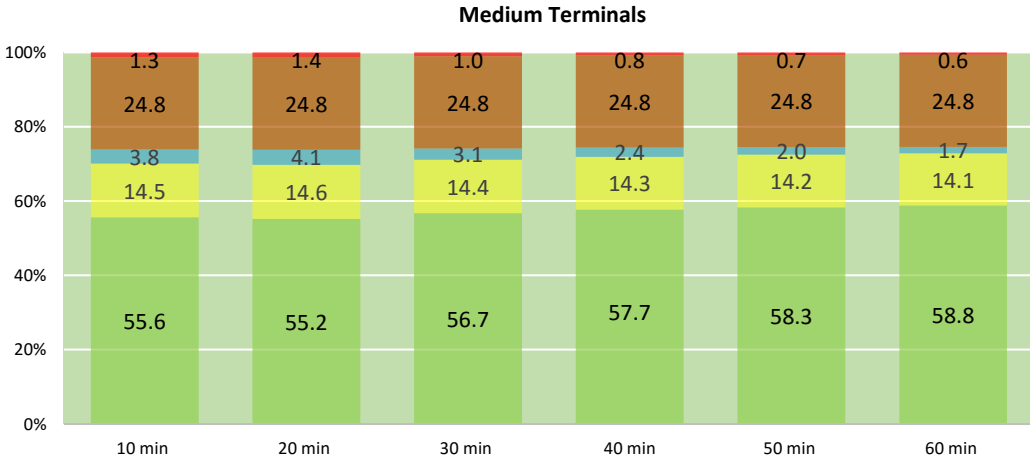
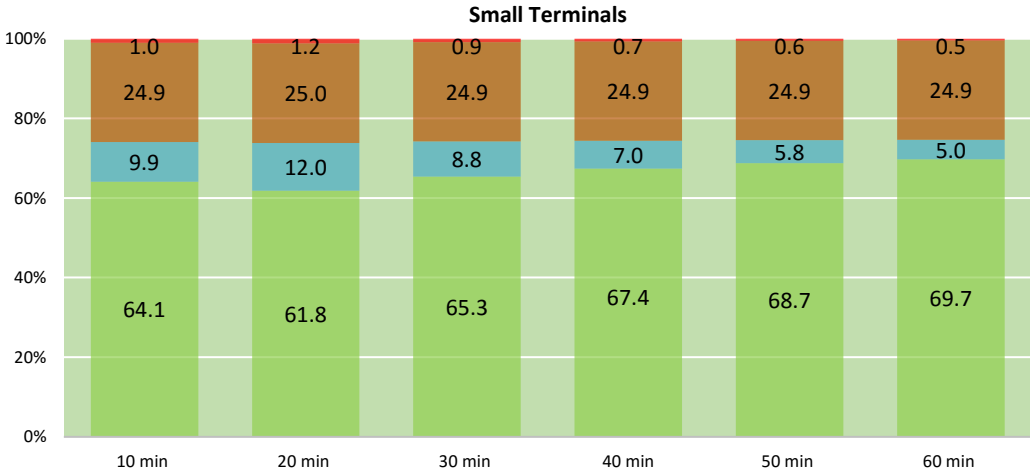

For all terminal sizes, increasing layover time, leads to increasing bus accumulation which leads to increased bus parking area requirement. This results in reduction of percentage of site area under other different functions.

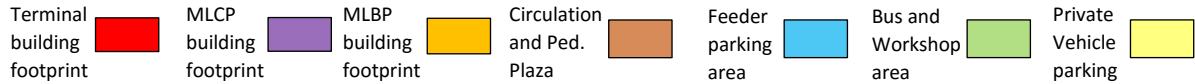

*The values represented here correspond 60 buses per hour for small terminal, 150 buses per hour for medium terminal and 390 buses per hour for large terminals

Scenario - 7 : With Real estate Development, Basement Car parking & at grade Bus Parking.

Typology	Local	B
Operation	Dynamic Bay	b

Open Area Distribution

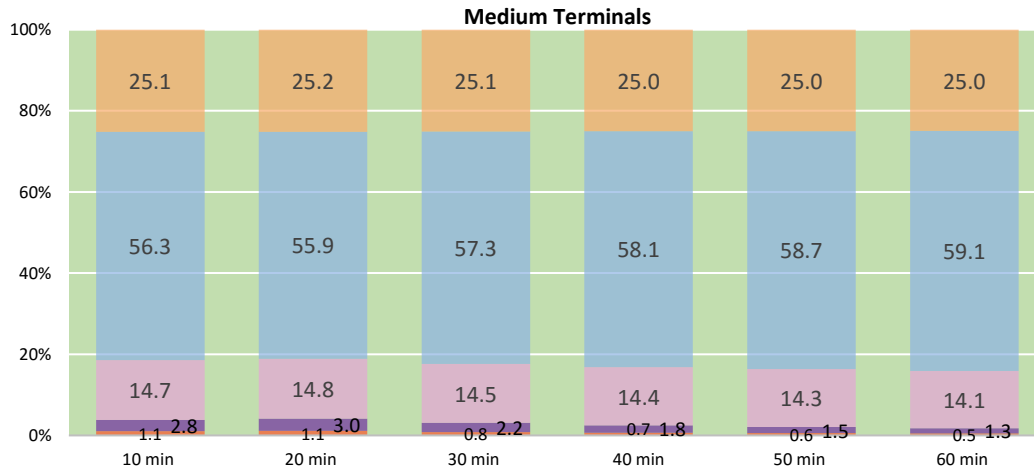
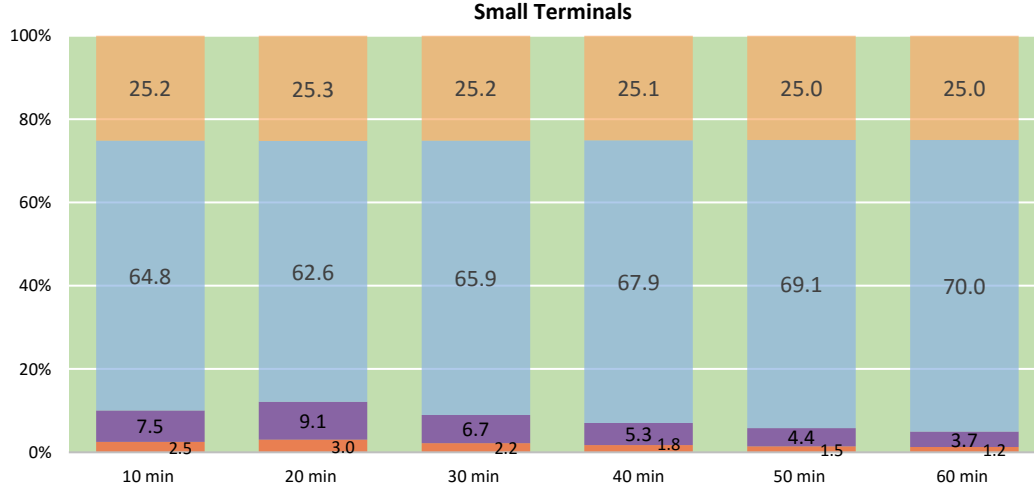

For all terminal sizes, increasing layover time, leads to increasing bus accumulation which leads to increased bus parking area requirement. This results in reduction of percentage of open area under other different functions.

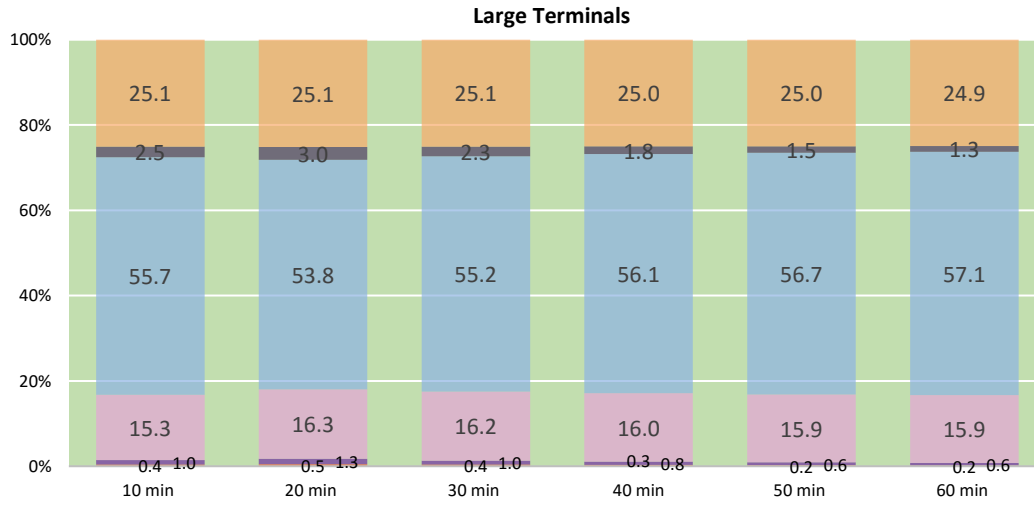

Small terminals have significantly lower area dedicated to car/private vehicle parking as compared to medium and large terminals. This is because car parking requirement surges due to demand for real estate development to offset the cost of medium and large terminal development.

The basement level parking is limited to two floors under the terminal building. This can accommodate only a part of the total parking demand for medium and large terminals.

Drop Off (red) Pick up (purple) Car Parking (pink) Bus Parking (light blue) Circulation area (medium blue) Workshop area (orange) Pedestrian plaza (green)

*The values represented here correspond 60 buses per hour for small terminal, 150 buses per hour for medium terminal and 390 buses per hour for large terminals

Spatial Requirements

Ba

Typology	Local	B
Operation	Fixed Route Bay	a

Built up Area Distribution

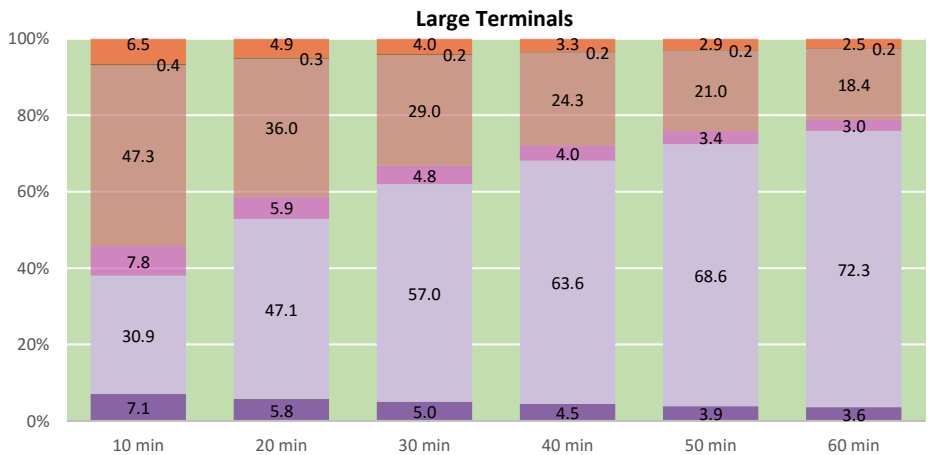
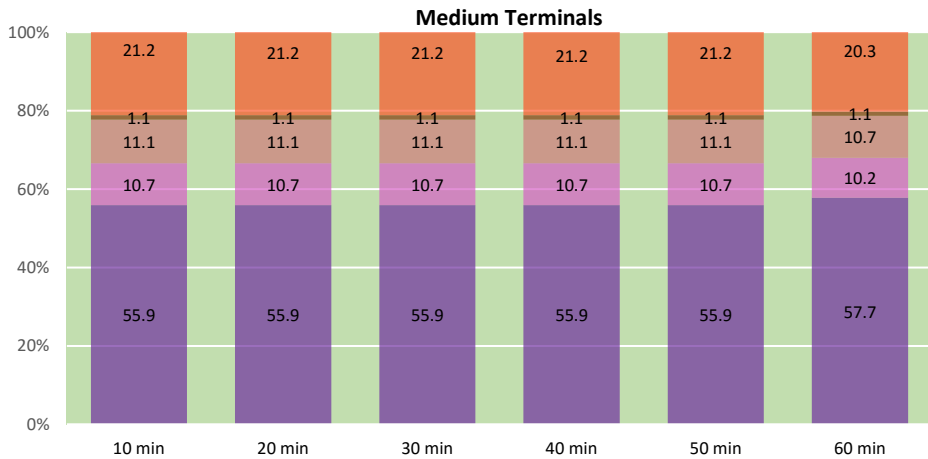
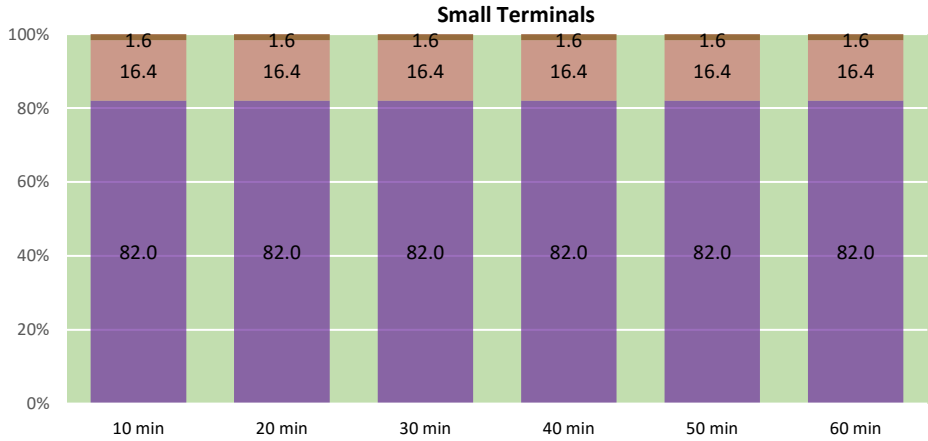

Built up area distribution does not include built up area under commercial/real estate development.

For local terminals, passengers accumulate at sheltered boarding bays. This eliminates/minimizes the requirement for a common passenger concourse.

- | | | | | | |
|----------------------|--|---------------------------------------|--|----------------|--|
| Passenger Concourse | | Services (Drinking water and Toilets) | | Information | |
| Canteen and Eateries | | Dormitories and Resting Rooms | | Security | |
| Terminal Office | | Cloak Room | | Ticket Counter | |

*The values represented here correspond 60 buses per hour for small terminal, 150 buses per hour for medium terminal and 390 buses per hour for large terminals

Typology	Local	A
Operation	Dynamic Bay	b

Built up Area Distribution

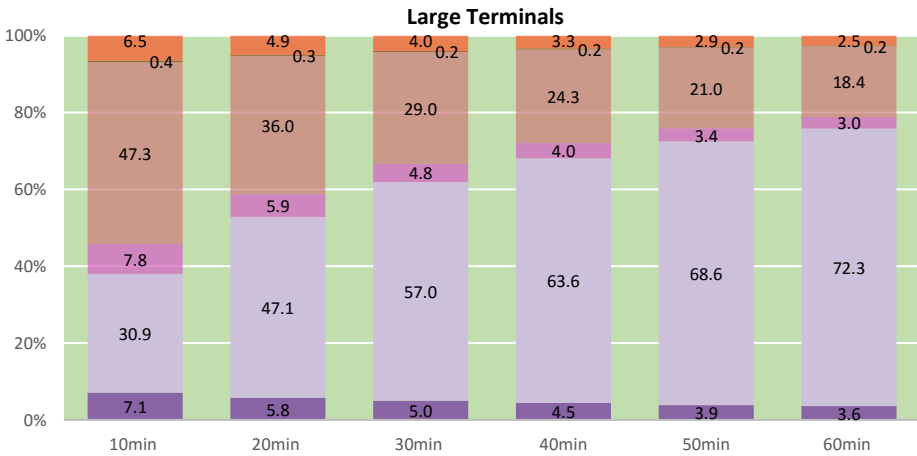
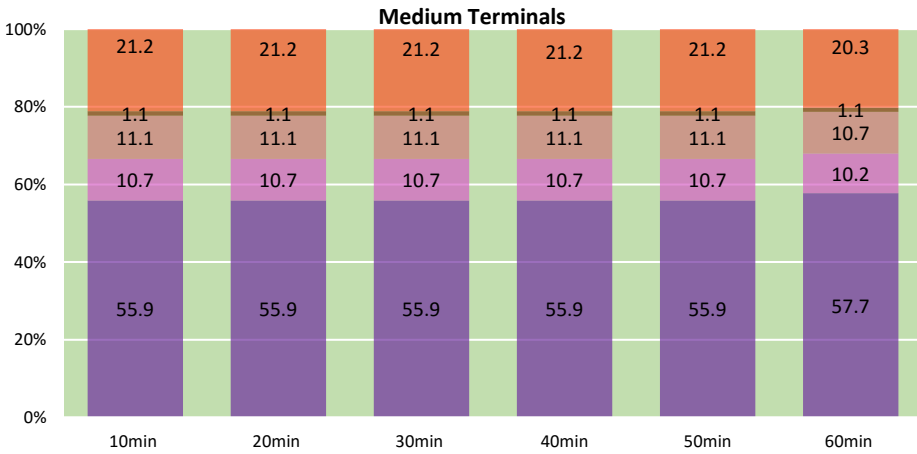
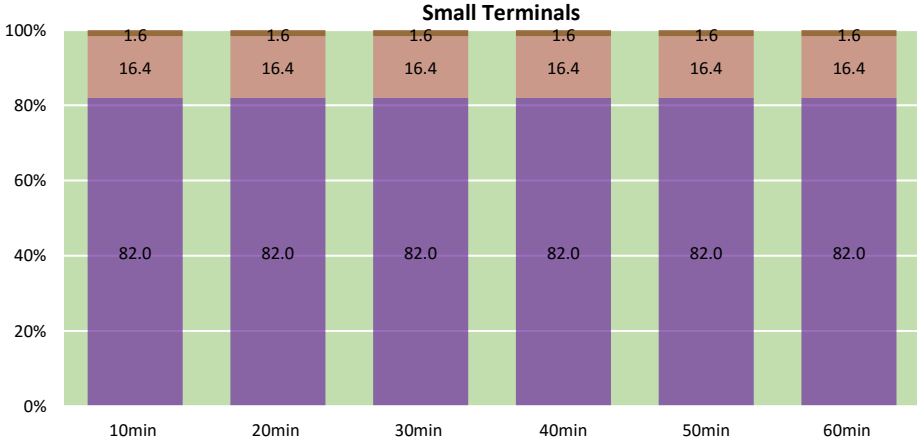

Built up area distribution does not include built up area under commercial/real estate development.

For local terminals, passengers accumulate at sheltered boarding bays. This eliminates/minimizes the requirement for a common passenger concourse.

- | | | | | | |
|----------------------|--|---------------------------------------|--|----------------|--|
| Passenger Concourse | | Services (Drinking water and Toilets) | | Information | |
| Canteen and Eateries | | Dormitories and Resting Rooms | | Security | |
| Terminal Office | | Cloak Room | | Ticket Counter | |

*The values represented here correspond 60 buses per hour for small terminal, 150 buses per hour for medium terminal and 390 buses per hour for large terminals

Spatial Requirements

Ba

Typology	Local	B
Operation	Fixed Route Bay	a

At grade Bus Parking Allocation

Small Terminals

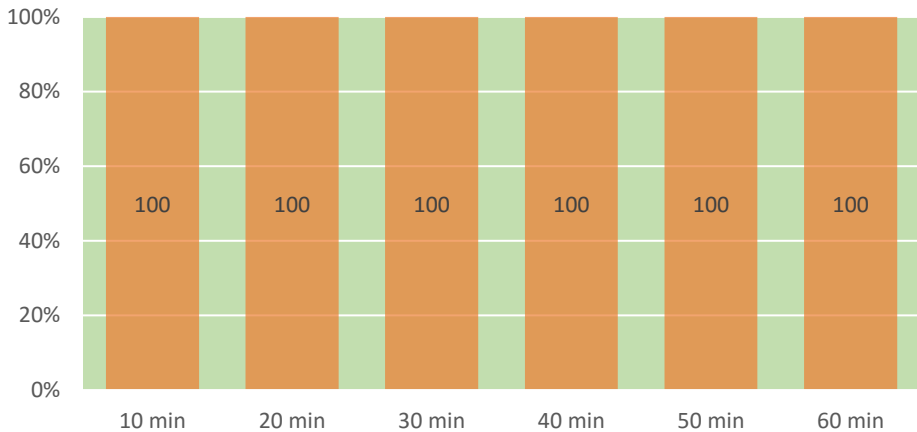

Medium Terminals

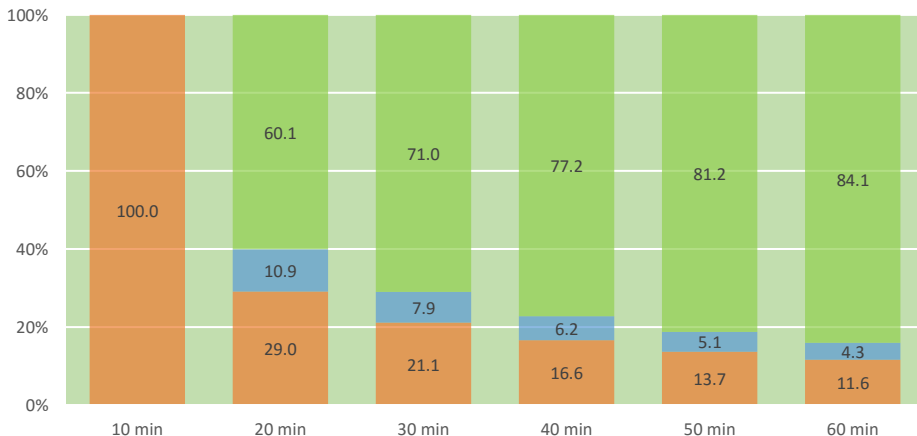

Large Terminals

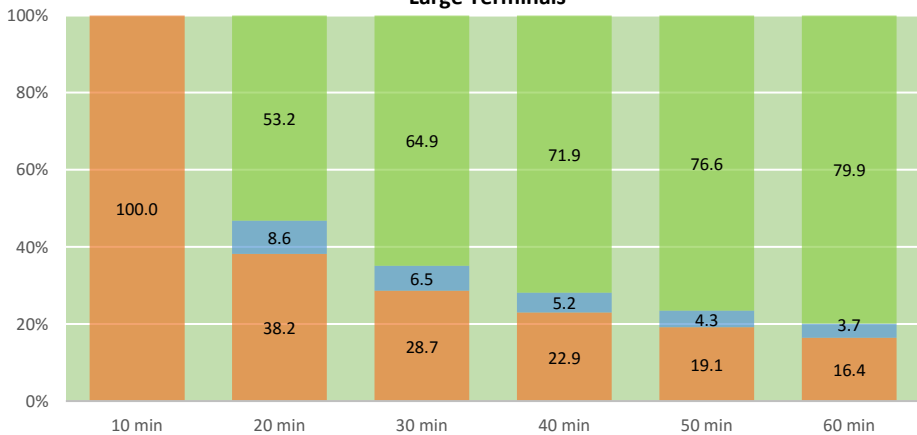

Because of low dwell time in case of local bus terminals, common bays (loading, offloading and idle) are preferred for small terminals where space saving by segregation of these bays is not significant.

In case of medium and large terminals, for layover time 10 minutes and less, operations of buses through idle parking bays is not feasible. Thus for these layover time, boarding bays serve as common, boarding, idle and offloading bays.

For medium and large terminals, Idle bus parking requirement increases with increasing layover time, across all terminal sizes. This results in relative reduction in percentage of area dedicated to loading and unloading bays.

Boarding Bays Off-loading Bays Idle Bus Bays

*The values represented here correspond 60 buses per hour for small terminal, 150 buses per hour for medium terminal and 390 buses per hour for large terminals

Typology	Local	B
Operation	Dynamic Bay	b

At grade Bus Parking Allocation

Small Terminals

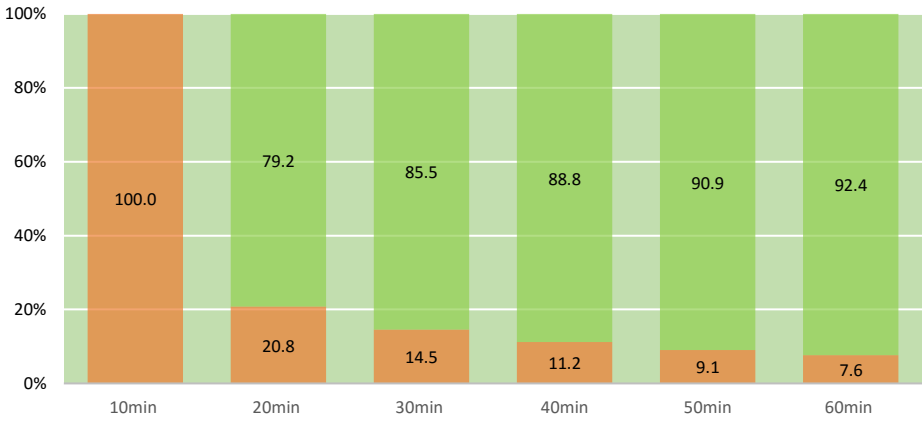

Medium Terminals

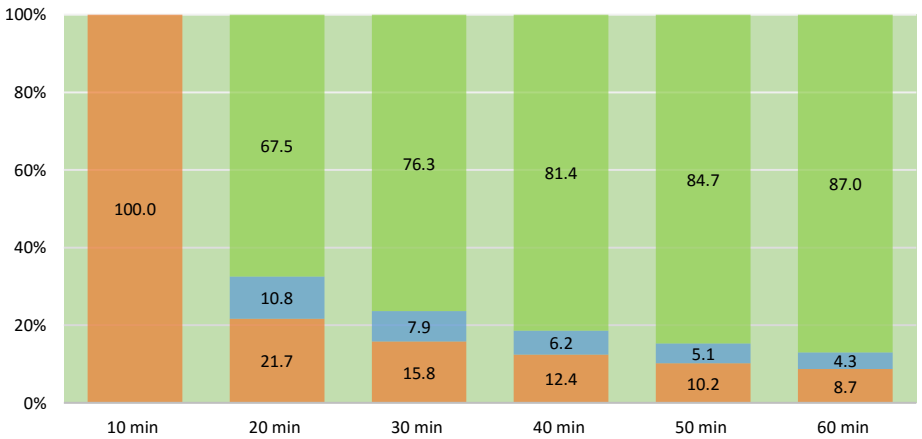

Large Terminals

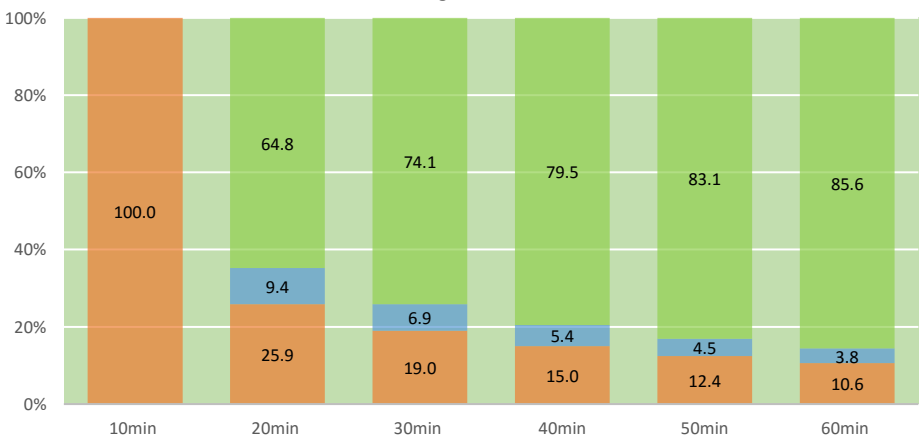

Because of low dwell time in case of local bus terminals, common bays (loading, offloading and idle) are preferred for small terminals where space saving by segregation of these bays is not significant.

In case of medium and large terminals, for layover time 10 minutes and less, operations of buses through idle parking bays is not feasible. Thus for these layover time, boarding bays serve as common, boarding, idle and offloading bays.

For medium and large terminals, Idle bus parking requirement increases with increasing layover time, across all terminal sizes. This results in relative reduction in percentage of area dedicated to loading and unloading bays.

Boarding Bays Off-loading Bays Idle Bus Bays

*The values represented here correspond 60 buses per hour for small terminal, 150 buses per hour for medium terminal and 390 buses per hour for large terminals

Spatial Requirements

Ba

Typology	Local	B
Operation	Fixed Route Bay	a

Multilevel Bus Parking Allocation

Small Terminals

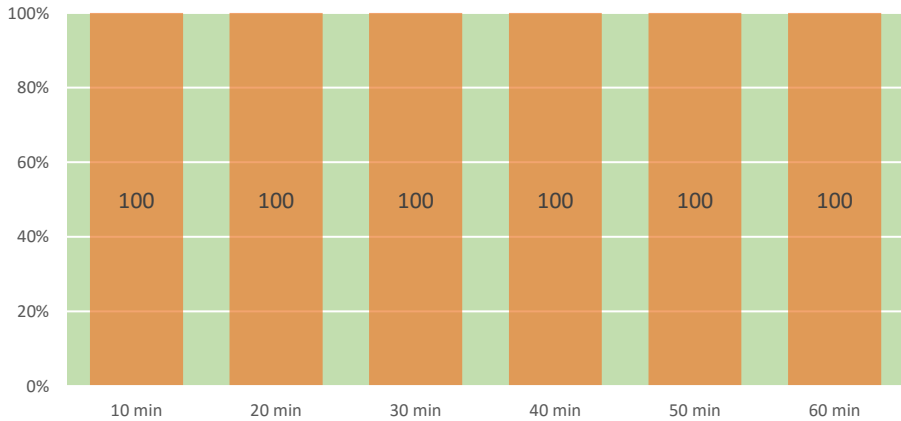

Medium Terminals

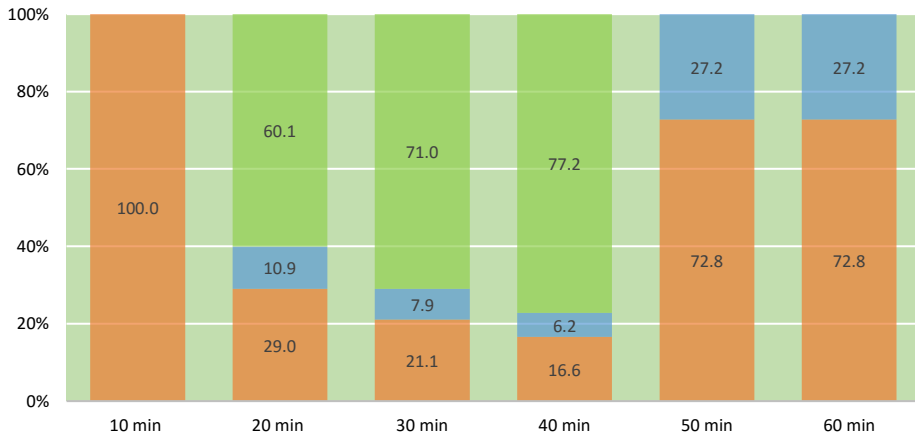

Large Terminals

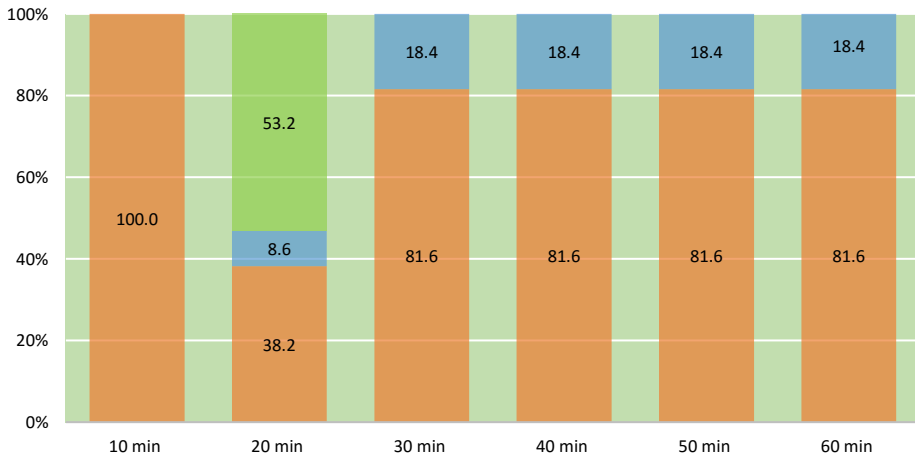

Because of low dwell time in case of local bus terminals, common bays (loading, offloading and idle) are preferred for small terminals where space saving by segregation of these bays is not significant.

In case of medium and large terminals, for layover time 10 minutes and less, operations of buses through idle parking bays is not feasible. Thus for these layover time, boarding bays serve as common, boarding, idle and offloading bays.

Requirement of idle bay drops down at layover time 50 min and 60 min for medium terminals and from 30 min to 60 min for large terminal as multilevel parking is introduced.

Boarding Bays Off-loading Bays Idle Bus Bays

*The values represented here correspond 60 buses per hour for small terminal, 150 buses per hour for medium terminal and 390 buses per hour for large terminals

Typology	Local	B
Operation	Dynamic Bay	b

Multilevel Bus Parking Allocation

Small Terminals

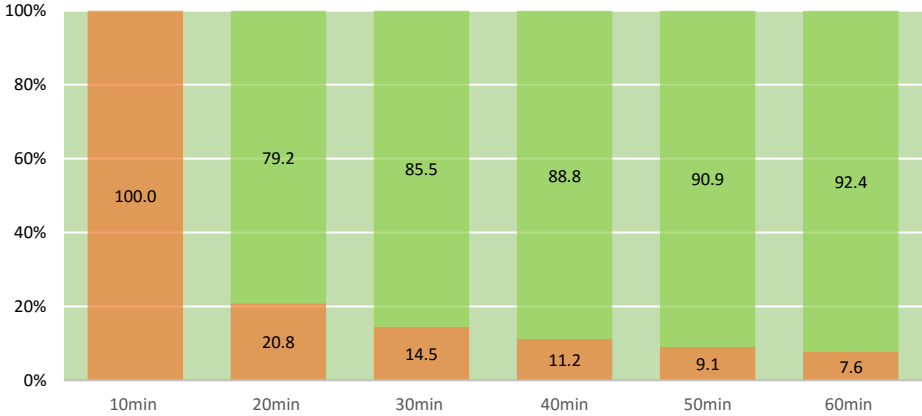

Medium Terminals

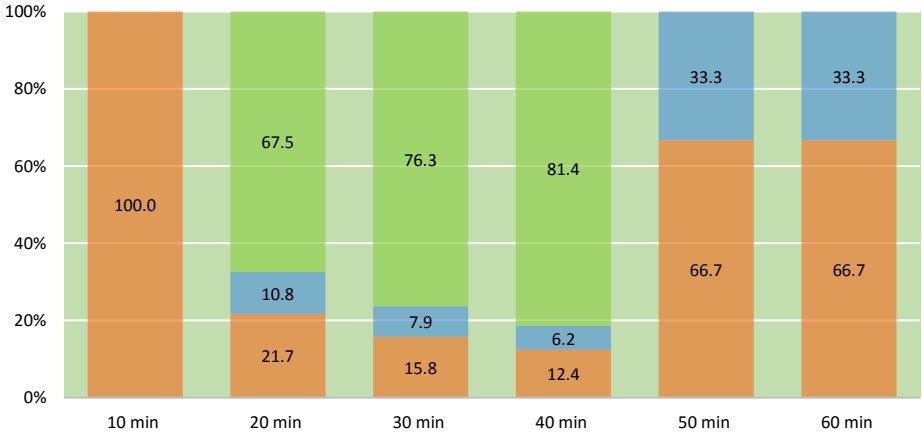

Large Terminals

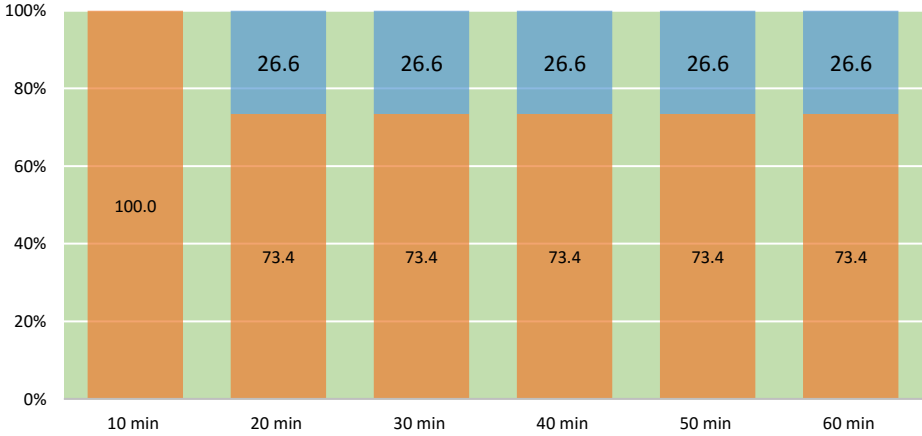

Because of low dwell time in case of local bus terminals, common bays (loading, offloading and idle) are preferred for small terminals where space saving by segregation of these bays is not significant.

In case of medium and large terminals, for layover time 10 minutes and less, operations of buses through idle parking bays is not feasible. Thus for these layover time, boarding bays serve as common, boarding, idle and offloading bays.

Requirement of idle bay drops down at layover time 50 min and 60 min for medium terminals and from 20 min to 60 min for large terminal as multilevel parking is introduced.

Boarding Bays Off-loading Bays Idle Bus Bays

*The values represented here correspond 60 buses per hour for small terminal, 150 buses per hour for medium terminal and 390 buses per hour for large terminals

7 References

1. Bangare, S.L., Kadam, A.D., Bangare, P.S., Katariya, P.V., Khot, C.A., & Kankure, N.R. 2013. *Solutions Concerning Information Systems for Real Time Bus Arrival*. IJEAT, 2,
2. Bhubaneswar Development Authority 2008. *Bhubaneswar Development Authority(Planning & Building Standards) Regulations- 2008*. *The Orissa Gazette Accessed 6 November 2015*.
3. Campbell, A. & Smith, B. 2008, *Palmerston North Bus Terminal Study*, Parsons Brinckerhoff, New Zealand.
4. Committee for Melbourne 2015. *Discussion Paper on Funding and Financing Infrastructure in Victoria*. Committee for Melbourne available from: www.melbourne.org.au
5. Department of Industrial Policy and Promotion 2011. *Discussion Paper On Financing Requirements Of Infrastructure And Industry*.
6. Higgins, N. *Transfer Development Rights*. 2015.
7. India Planning Commission 2011, *Recommendations of Working Group on Urban Transport for 12th Five Year Plan*, Planning Commission, Government of India..
8. Khan.R,H. *Financing Strategies for Urban Infrastructure: Trends and Challenges*. 2013. *RBI Bulletin*.
9. Lall.B, R. & Anand, R. 2009. *Financing Infrastructure*. IDFC Occasional Paper Series, 3, available from: www.idfc.com
10. Longwood Small Business Development Center 2012. *Type of Financing*.
11. MoUD, M. o. U. D. 2006, *National Urban Transport Policy*, Ministry of Urban Development.
12. Nallathiga, R. 2015.
13. *Land-based Resource Mobilisation for Urban Development Some Options for and Experiences of ULBs in India*. *Land-based Resource Mobilisation for Urban Development Some Options for and Experiences of ULBs in India*
14. *Pace Suburban Bus. Transit Supportive Guidelines*. 2015. Chicago..
15. Parashar, L. & Dubey, K.G. 2011.
16. *Efficacy of public private partnership (PPP)for city bus operation experience from Indian Cities.. Association for European Transport and Contributors 2011*
17. *Planning Department Hongkong 2014. Hong - Kong planning Standards and Guidelines Hong Kong, The government of the Hong kong Special Administrative Region*.
18. *Public Private Partnerships - The Haryana Exprience*.2015.
19. Rodrique, J.-P., Comtois, C., & Slack, B. 2013. *The Geography of Transport Systems, Third ed*. New York, Routledge.
20. *The Business Council of Australia (BCA) 2013, Securing Investment in Australia's Future: Infrastructure Funding and Financing, PricewaterhouseCoopers, Melbourne,Australia*.
21. *Transfer of Development Rights (TDR) 2015*.
22. *Transit Infrastructure Security Working Group 2009. Security Lighting for Transit Passenger Facilities. APTA Standard Development Program - Recommended Practices*.Washington, DC, The American Public Transportation Association.
23. *TransLink 2011, Public Transport Infrastructure Manual*., TransLink Transit Authority, Brisbane.
24. *Transportation Research Board 1996, Report - 19 : Guidelines for the Location and Design of Bus Stops*, National Academy Press, Washington, D.C. 19.
25. Trapeze. *Passenger Information Systems:What Transit Agencies Need to Know*. 2015. Trapeze.
26. *TRB 2011, ACPR Report 55: Passenger Level of Service and Spatial Planning for Airport Terminals*, Transportation Reserach Board, Washington D.C..
27. *United Nations Economic and Social Commission for Asia and the Pacific 2011*,
28. *A Guidebook on public private partnership in infrastructure, United Nations 2011, Bangkok*.
29. Vanajakshi, I., Ramadurai, G., & Anand Asha 2010, *Intelligent Transport Systems,synthesis report on ITS including Issues and Challenges in India*, Centre for Excellence in Urban Transport , IIT M, Madras.
30. *Washington Metropolitan area transit authority 2009, Guidelines for the Design and Placement of Transit Stops for the Washington Metropolitan Area Transit Authority, KFH GROUP, INC., Bethesda, Maryland*.
31. *WBDG Secure/Safe Committee. Fire Protection*. 2014. Washington, DC, National Institute of Building Science..
32. *Wikipedia. Passenger Information System*. 2015.

SG Architects

www.sgarchitects.in

6151/8 Sector D, Pocket 6,
Vasant Kunj
New Delhi 110070

Tel 011 - 42147521
Tel/Fax 011 - 26131060
email : design@sgarchitects.in

