

Volume VI Drawings

DRAWINGS: IMPROVEMENT OF WATER DISTRIBUTION SYSTEM

| Sr. No. | Drawing No | Drawing Name |
|---------|--------------------------------------|--|
| 1 | WTE – 2297-00-W-2.01-R1-Sheet 1 of 1 | IMPROVEMENT OF WATER DISTRIBUTION SYSTEM FOR DMA 1 & 18 (PHE STORE ESR) (IMMEDIATE STAGE - 2018) FOR ABD AREA |
| 2 | WTE – 2297-00-W-2.02-R1-Sheet 1 of 1 | IMPROVEMENT OF WATER DISTRIBUTION SYSTEM FOR DMA 2 (IMMEDIATE STAGE - 2018) FOR ABD AREA |
| 3 | WTE – 2297-00-W-2.03-R1-Sheet 1 of 1 | IMPROVEMENT OF WATER DISTRIBUTION SYSTEM FOR DMA 3, 4 & 5 (HIGH LEVEL GSR) (IMMEDIATE STAGE - 2018) FOR ABD AREA |
| 4 | WTE – 2297-00-W-2.04-R1-Sheet 1 of 1 | IMPROVEMENT OF WATER DISTRIBUTION SYSTEM FOR DMA 7 and 8(HIGH LEVEL GSR) (IMMEDIATE STAGE - 2018) FOR ABD AREA |
| 5 | WTE – 2297-00-W-2.05-R1-Sheet 1 of 1 | IMPROVEMENT OF WATER DISTRIBUTION SYSTEM FOR DMA 10,11,12,21,24 (HIGH LEVEL GSR) (IMMEDIATE STAGE - 2018) FOR ABD AREA |
| 6 | WTE – 2297-00-W-2.06-R1-Sheet 1 of 1 | IMPROVEMENT OF WATER DISTRIBUTION SYSTEM FOR DMA 13 (KASTURBA) (IMMEDIATE STAGE - 2018) FOR ABD AREA |
| 7 | WTE – 2297-00-W-2.07-R1-Sheet 1 of 1 | IMPROVEMENT OF WATER DISTRIBUTION SYSTEM FOR DMA 16 & 20 (PARCIVAL GSR A & B) (IMMEDIATE STAGE - 2018) FOR ABD AREA |
| 8 | WTE – 2297-00-W-2.08-R1-Sheet 1 of 1 | IMPROVEMENT OF WATER DISTRIBUTION SYSTEM FOR DMA 17 (UJANI) (IMMEDIATE STAGE - 2018) FOR ABD AREA |
| 9 | WTE – 2297-00-W-2.09-R1-Sheet 1 of 1 | IMPROVEMENT OF WATER DISTRIBUTION SYSTEM FOR DMA 19 (HIGH LEVEL ESR) (IMMEDIATE STAGE - 2018) FOR ABD AREA |
| 10 | WTE – 2297-00-W-2.10-R1-Sheet 1 of 1 | IMPROVEMENT OF WATER DISTRIBUTION SYSTEM FOR DMA 23 (IMMEDIATE STAGE - 2018) FOR ABD AREA |
| 11 | WTE – 2297-00-W-2.11-R1-Sheet 1 of 1 | IMPROVEMENT OF WATER DISTRIBUTION SYSTEM FOR DMA 1 & 18 (PHE STORE ESR) (ULTIMATE STAGE - 2051) FOR ABD AREA |
| 12 | WTE – 2297-00-W-2.12-R1-Sheet 1 of 1 | IMPROVEMENT OF WATER DISTRIBUTION SYSTEM FOR DMA 2 (ULTIMATE STAGE - 2051) FOR ABD AREA |
| 13 | WTE – 2297-00-W-2.13-R1-Sheet 1 of 1 | IMPROVEMENT OF WATER DISTRIBUTION SYSTEM FOR DMA 3, 4 & 5 (HIGH LEVEL GSR) (ULTIMATE STAGE - 2051) FOR ABD AREA |
| 14 | WTE – 2297-00-W-2.14-R1-Sheet 1 of 1 | IMPROVEMENT OF WATER DISTRIBUTION SYSTEM FOR DMA 7 and 8(HIGH LEVEL GSR) (ULTIMATE STAGE - 2051) FOR ABD AREA |
| 15 | WTE – 2297-00-W-2.15-R1-Sheet 1 of 1 | IMPROVEMENT OF WATER DISTRIBUTION SYSTEM FOR DMA 10,11,12,21,24 (HIGH LEVEL GSR) (ULTIMATE STAGE - 2051) FOR ABD AREA |

Appointment of Contractor for Carrying out Works of Improvements to Water Distribution System & Sewerage System in ABD Area of Solapur Smart City

| | | |
|-----------|---|---|
| 16 | WTE – 2297-00-W-2.16-R1-Sheet 1 of 1 | IMPROVEMENT OF WATER DISTRIBUTION SYSTEM FOR DMA 13 (KASTURBA) (ULTIMATE STAGE - 2051) FOR ABD AREA |
| 17 | WTE – 2297-00-W-2.17-R1-Sheet 1 of 1 | IMPROVEMENT OF WATER DISTRIBUTION SYSTEM FOR DMA 16 & 20 (PARCIVAL GSR A & B) (ULTIMATE STAGE - 2051) FOR ABD AREA |
| 18 | WTE – 2297-00-W-2.18-R1-Sheet 1 of 1 | IMPROVEMENT OF WATER DISTRIBUTION SYSTEM FOR DMA 17 (UJANI) (ULTIMATE STAGE - 2051) FOR ABD AREA |
| 19 | WTE – 2297-00-W-2.19-R1-Sheet 1 of 1 | IMPROVEMENT OF WATER DISTRIBUTION SYSTEM FOR DMA 19 (HIGH LEVEL ESR) (ULTIMATE STAGE - 2051) FOR ABD AREA |
| 20 | WTE – 2297-00-W-2.20-R1-Sheet 1 of 1 | IMPROVEMENT OF WATER DISTRIBUTION SYSTEM FOR DMA 23 (ULTIMATE STAGE - 2051) FOR ABD AREA |

DRAWINGS: TYPICAL DETAILS

Appointment of Contractor for Carrying out Works of Improvements to Water Distribution System & Sewerage System in ABD Area of Solapur Smart City

DRAWINGS: IMPROVEMENT TO SEWER NETWORK

For DMA 18

| Proposed Pipe DI K9 | |
|------------------------|---------------------|
| Diameter of pipe in mm | Length of pipe in M |
| 100mm | 4537 |
| 150mm | 432 |
| 200mm | 246 |
| 250mm | 410 |
| 300mm | 29 |
| 350mm | 58 |
| Total Length | 5702 |

| Bulk Flow Meter | | | |
|-----------------|------------------------------|-----|---------------------------|
| Description | Diameter of Flow Meter in mm | Nos | Type of flow meter |
| BFM 2 | 150 | 1 | Electromagnetic full bore |

| Pressure Reducing Valve (PRV) | | | |
|-------------------------------|-----------------------|------------------------|-------------------------------|
| Sr. No. | Diameter of PRV in mm | Diameter of Pipe in mm | Initial Pressure Setting in M |
| | | | 2016 2015 2014 2013 |
| PRV 1 | 200 | 300 | 16 5 17 10 |
| PRV 3 | 200 | 300 | 5 8 7 11 |
| PRV 4 | 100 | 250 | 6 7 10 10 |
| PRV 5 | 150 | 250 | 5 5 12 11 |

| Proposed Sluice Valve DI | |
|--------------------------------|-----------|
| Diameter of Sluice Valve in mm | Numbers |
| 100 | 25 |
| 200 | 1 |
| 250 | 4 |
| 300 | 2 |
| 350 | 1 |
| Total Numbers | 33 |

| No of Pressure Loggers | |
|-----------------------------|---------|
| No of Water Quality Loggers | Numbers |
| 5 | 5 |

| Air Valve (AV) | |
|-----------------------------|-----|
| Diameter of Air Valve in mm | Nos |
| 100 | 1 |

| Pressure Logger (Transmitter) | | | |
|-------------------------------|--------------|------------------|--------------------|
| Sr. No. | Tag No. | Near to Junction | Line Pressure in M |
| 1 | DMA-01-PL-01 | J-32 | 7 |
| 2 | DMA-01-PL-02 | J-51 | 7 |
| 3 | DMA-01-PL-03 | J-136 | 10 |
| 4 | DMA-01-PL-04 | J-142 | 11 |
| 5 | DMA-01-PL-05 | J-133 | 10 |
| 6 | DMA-18-PL-01 | J-166 | 16 |
| 7 | DMA-18-PL-02 | J-113 | 9 |
| 8 | DMA-18-PL-03 | J-140 | 11 |
| 9 | DMA-18-PL-04 | J-118 | 6 |
| 10 | DMA-18-PL-05 | J-161 | 12 |

| Water Quality Logger | | | |
|----------------------|--------------|------------------|--------------------|
| Sr. No. | Tag No. | Near to Junction | Line Pressure in M |
| 1 | DMA-01-QA-01 | J-32 | 7 |
| 2 | DMA-01-QA-02 | J-51 | 7 |
| 3 | DMA-01-QA-03 | J-136 | 10 |
| 4 | DMA-01-QA-04 | J-142 | 11 |
| 5 | DMA-01-QA-05 | J-133 | 10 |
| 6 | DMA-18-QA-01 | J-166 | 16 |
| 7 | DMA-18-QA-02 | J-113 | 9 |
| 8 | DMA-18-QA-03 | J-140 | 11 |
| 9 | DMA-18-QA-04 | J-118 | 6 |
| 10 | DMA-18-QA-05 | J-161 | 12 |

| Flow Meter | | |
|------------|--------------|------------------|
| Sr. No. | Tag No. | Near to Junction |
| 1 | DMA-01-FT-01 | J-32 |
| 2 | DMA-18-FT-01 | J-166 |

For DMA 1

| Proposed Pipe DI K9 | | |
|------------------------|---------------------|---------|
| Diameter of pipe in mm | Length of pipe in M | Numbers |
| 100mm | 4078 | 4078 |
| 150mm | 681 | 681 |
| 200mm | 21 | 21 |
| 300mm | 293 | 293 |
| Total Length | 5073 | |

| Proposed Sluice Valve DI | | |
|--------------------------------|-----------|---------------|
| Diameter of Sluice Valve in mm | Numbers | Total Numbers |
| 100 | 25 | 25 |
| 150 | 3 | 3 |
| 250 | 2 | 2 |
| Total Numbers | 30 | |

| Bulk Flow Meter | | | |
|-----------------|------------------------------|-----|---------------------------|
| Description | Diameter of Flow Meter in mm | Nos | Type of flow meter |
| BFM 1 | 150 | 1 | Electromagnetic full bore |

| Pressure Reducing Valve (PRV) | | | |
|-------------------------------|-----------------------|------------------------|-------------------------------|
| Description | Diameter of PRV in mm | Diameter of Pipe in mm | Initial Pressure Setting in M |
| | | | 2016 2015 2014 2013 |
| PRV 2 | 400 | 600 | 16 1 5 17 11 |

| No of Pressure Loggers | |
|------------------------|---------|
| No of Quality Loggers | Numbers |
| 5 | 5 |

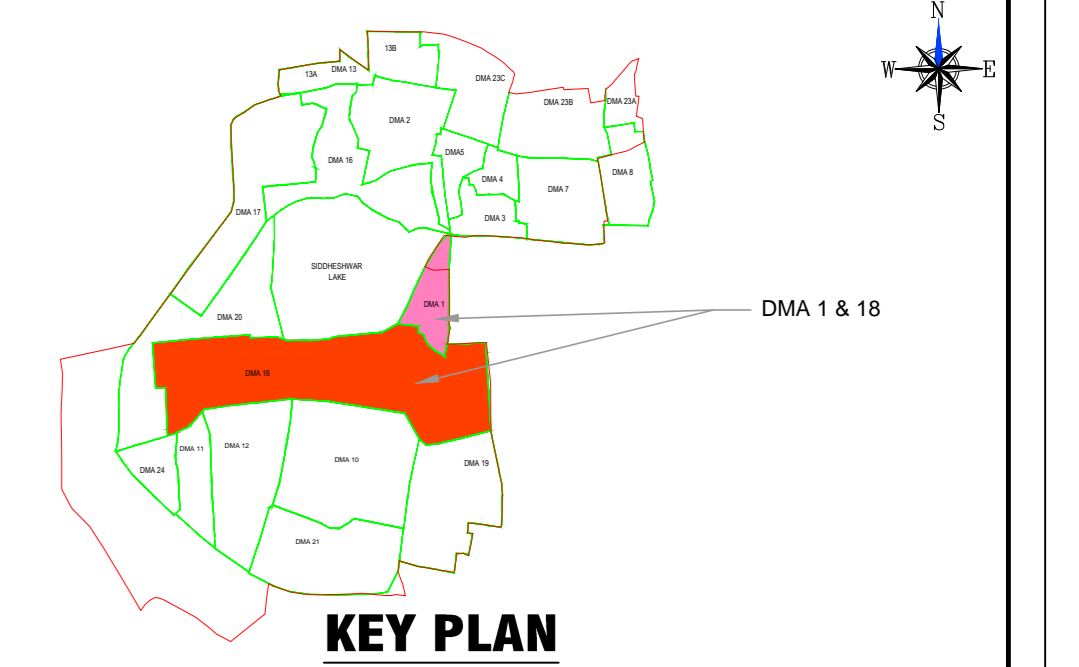

NOTES :-

ⓐ DUE TO NO DEVELOPMENT IN FUTURE WATER PIPE LINE IS NOT PROPOSED ON OTHER SIDE OF SMART ROADS

REFERENCE DRG. NO.

LEGEND :-

- ⓧ V = PROPOSED SLUICE VALVE
 - ⓧ PRV = PROPOSED PRESSURE REDUCING VALVE
 - ⓧ AV = PROPOSED AIR VALVE
 - ⓧ PL = PROPOSED PRESSURE LOGGERS
 - DMA = DISTRICT METREING AREA
 - ESR = ELEVATED SERVICE RESERVOIR
 - ⓧ BFM = PROPOSED BULK FLOW METRE
 - ⓧ Q = PROPOSED WATER QUALITY LOGGERS
- JUNCTION NO. / PRESSURE IN METRE HAZEN WILLIAMS CONSTANT (C) JUNCTION NO. / PRESSURE IN METRE
- ⓧ DIAMETER OF PIPE IN mm
- | C' VALUE | |
|-------------------|----------------------|
| 100 | 120 |
| EXISTING CI PIPES | EXISTING DI KT PIPES |
| 140 | PROPOSED DI K9 PIPES |
- SMART ROAD
 - - - ABD AREA BOUNDARY
 - - - DMA BOUNDARY

WTE DRAWING FOR COMMENTS / APPROVAL

SIGNATURE _____ DATE _____

| | | | | | |
|------|----------|-------------|-------|------|------|
| 4 | | | | | |
| 3 | | | | | |
| 2 | | | | | |
| 1 | 20.07.18 | FOR TENDER | BR | GNG | MS |
| 0 | 30.06.18 | FOR TENDER | BR | GNG | MS |
| Rev. | Date | Description | Drawn | Clk. | App. |

File name: WTE-2297-HI_ZONE 1 & 18_IMMEDIATE STAGE (2018).dwg

WTE Wadia Techno Engg. Services Ltd. **Louis Berger**

Client: SOLAPUR CITY DEVELOPMENT CORPORATION LTD.

Project: DESIGN, DEVELOP, MANAGE & IMPLEMENT URBAN INFRASTRUCTURE SERVICES PROJECTS UNDER SMART CITY MISSION (SCM) IN SOLAPUR CITY

Title: IMPROVEMENT OF WATER DISTRIBUTION SYSTEM FOR DMA 1 & 18 (PHE STORE ESR) (IMMEDIATE STAGE - 2018) FOR ABD AREA

North of Scale: **A0** **WTE-2297** 00 W 2.01 R1 1 1

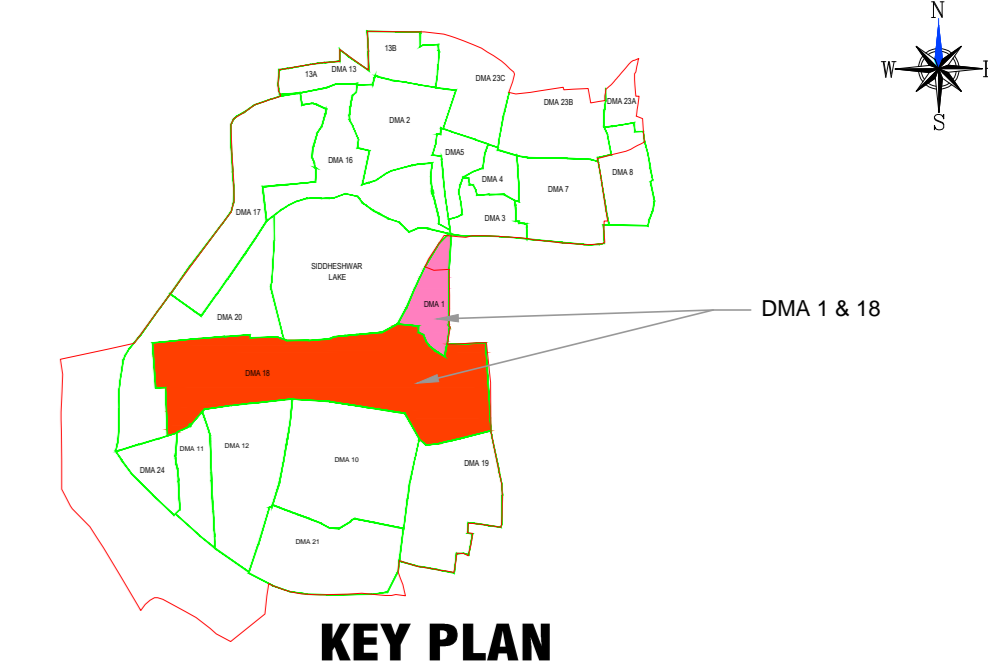
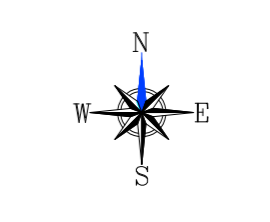

NOTES :-

Ⓐ DUE TO NO DEVELOPMENT IN FUTURE WATER PIPE LINE IS NOT PROPOSED ON OTHER SIDE OF SMART ROADS

REFERENCE DRG. NO.

LEGEND :-

- ⊕ V = PROPOSED SLUICE VALVE
 - ⊗ PRV = PROPOSED PRESSURE REDUCING VALVE
 - ⊙ AV = PROPOSED AIR VALVE
 - ⊙ PL = PROPOSED PRESSURE LOGGERS
 - ⊙ DMA = DISTRICT METREING AREA
 - ⊙ ESR = ELEVATED SERVICE RESERVOIR
 - ⊙ BFM = PROPOSED BULK FLOW METRE
 - ⊙ Q = PROPOSED WATER QUALITY LOGGERS
- JUNCTION NO. / PRESSURE IN METRE HAZEN WILLIAMS CONSTANT (C) JUNCTION NO. / PRESSURE IN METRE
- DIAMETRE OF PIPE IN mm
- | 'C' VALUE | |
|-----------|----------------------|
| 100 | EXISTING CI PIPES |
| 120 | EXISTING DI KT PIPES |
| 140 | PROPOSED DI K9 PIPES |
- SMART ROAD
 - - - ABD AREA BOUNDARY
 - - - DMA BOUNDARY

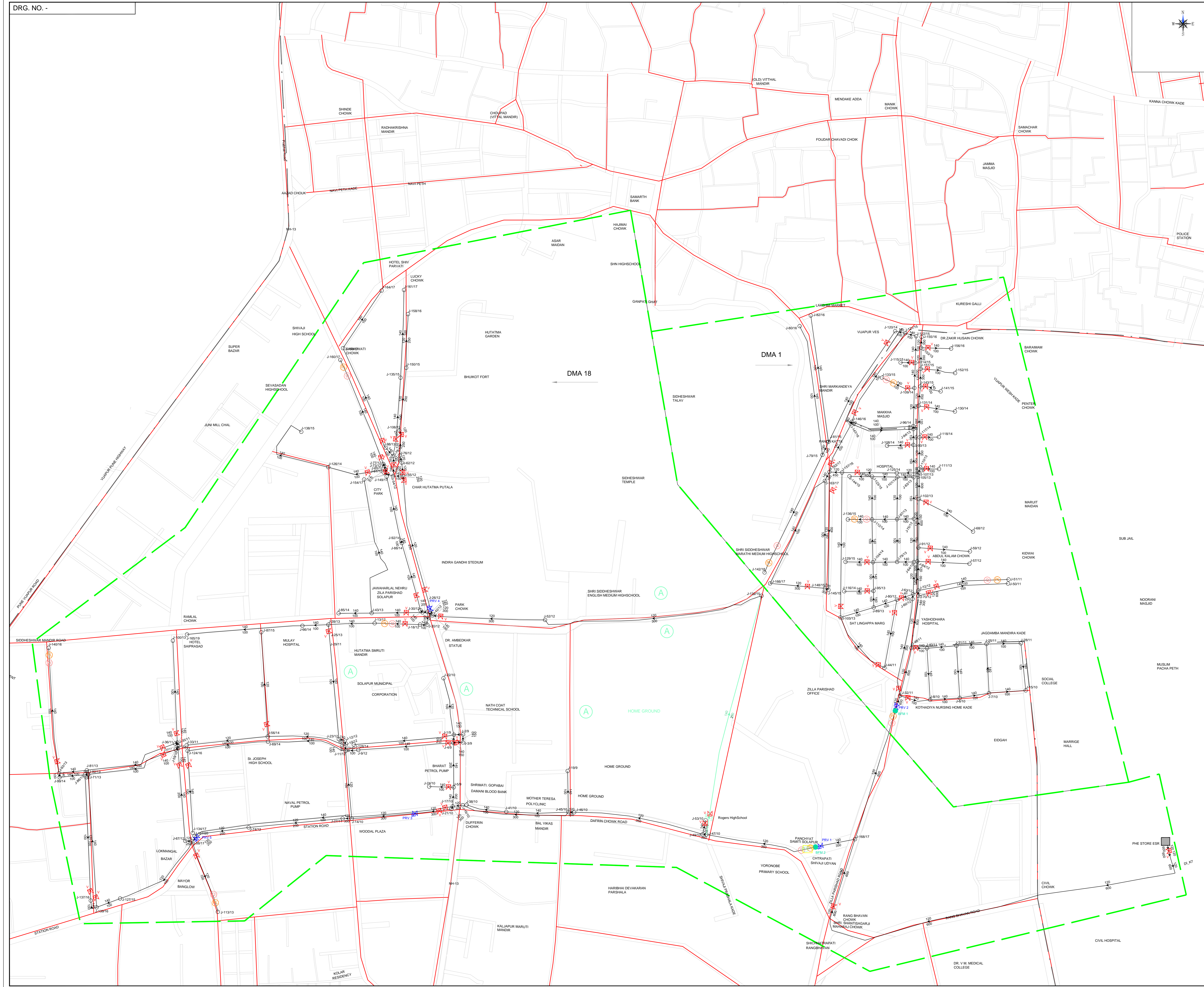

WTE DRAWING FOR COMMENTS / APPROVAL

SIGNATURE _____ DATE _____

| | | | | | |
|------|----------|-------------|-------|-----|------|
| 4 | | | | | |
| 3 | | | | | |
| 2 | | | | | |
| 1 | 20.07.18 | FOR TENDER | BR | GNG | MS |
| 0 | 30.06.18 | FOR TENDER | BR | GNG | MS |
| Rev. | Date | Description | Drawn | Ck. | App. |

Wadia Techno Engg. Services Ltd. Louis Berger

Client: SOLAPUR CITY DEVELOPMENT CORPORATION LTD.

Project: DESIGN, DEVELOP, MANAGE & IMPLEMENT URBAN INFRASTRUCTURE SERVICES PROJECTS UNDER SMART CITY MISSION (SCM) IN SOLAPUR CITY

Title: IMPROVEMENT OF WATER DISTRIBUTION SYSTEM FOR DMA 1 & 18 (PHE STORE ESR) (ULTIMATE STAGE - 2051) FOR ABD AREA

North of Scale A 0 NTS WTE-2297 00 W 2.11 R1 1 1

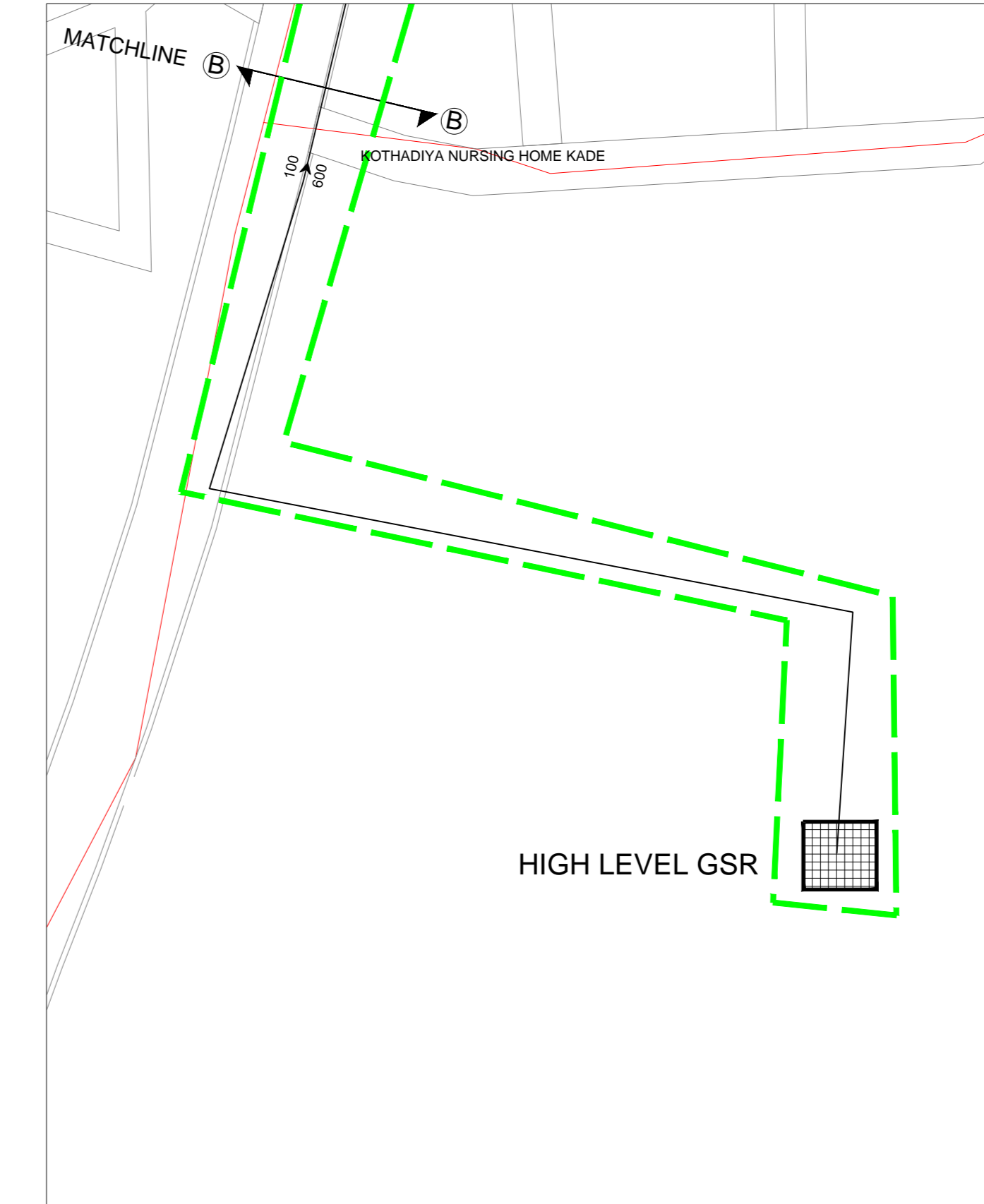
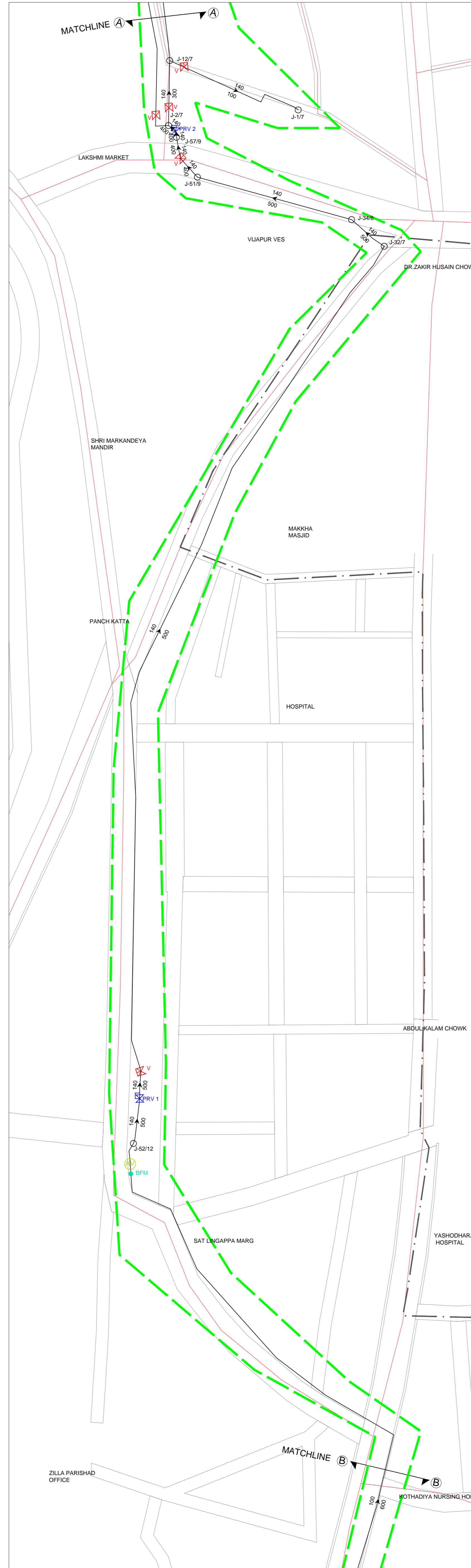
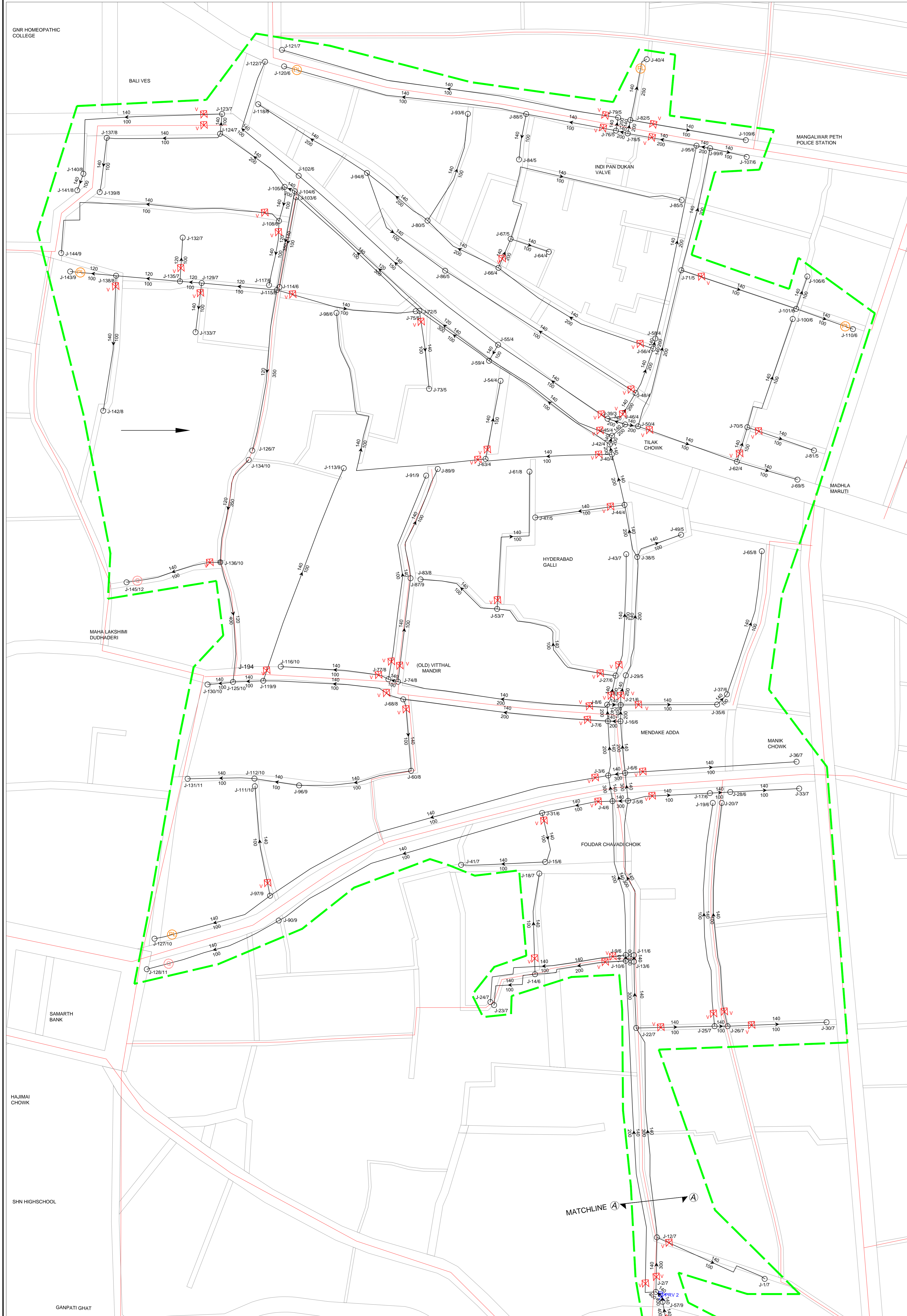

For DMA 2

| Proposed Pipe DI K9 | | Bulk Flow Metre | |
|------------------------|---------------------|-----------------|------------------------------|
| Diameter of pipe in mm | Length of pipe in M | Description | Diameter of Flow metre in mm |
| 100mm | 5598 | BFM 1 | 150 |
| 150mm | 234 | | |
| 200mm | 1720 | | |
| 300mm | 341 | | |
| 400mm | 25 | | |
| 500mm | 592 | | |
| Total Length | 8510 | | |

| Proposed Sluice Valve DI | | Pressure Reducing Valve (PRV) | |
|--------------------------------|---------|-------------------------------|-----------------------|
| Diameter of Sluice Valve in mm | Numbers | Description | Diameter of PRV in mm |
| 100 | 45 | PRV 1 | 400 |
| 150 | 1 | PRV 2 | 300 |
| 200 | 10 | | |
| 300 | 1 | | |
| 400 | 1 | | |
| 500 | 1 | | |
| Total Numbers | 59 | | |

| Proposed Air Valve | | No. of Pressure Loggers | |
|-----------------------------|-----|-------------------------|---------|
| Diameter of Air Valve in mm | Nos | Description | Numbers |
| 100 | 1 | | 5 |
| 150 | 1 | | |
| 200 | 1 | | |
| 300 | 1 | | |
| 400 | 1 | | |
| 500 | 1 | | |
| Total Numbers | 5 | | |

| Proposed Pressure Reducing Valve | | No. of Water Quantity Loggers | |
|----------------------------------|-----|-------------------------------|---------|
| Diameter of PRV in mm | Nos | Description | Numbers |
| 150 | 1 | | 2 |
| 200 | 1 | | |
| 300 | 1 | | |
| 400 | 1 | | |
| 500 | 1 | | |
| Total Numbers | 5 | | |

| Proposed Pressure Logger | | Water Quality Logger | |
|--------------------------|----------------------|----------------------|------------------|
| Tag No. | Line Pressure in Bar | Tag No. | Need to Junction |
| 1 | 140 | 1 | J-142 |
| 2 | 134 | 2 | J-144 |
| 3 | 174 | | |
| 4 | 140 | | |
| 5 | 140 | | |

| Flow Metre | |
|------------|------------------|
| Tag No. | Need to Junction |
| 1 | J-95 |

NOTES :-
 (A) DUE TO NO DEVELOPMENT IN FUTURE WATER PIPE LINE IS NOT PROPOSED ON OTHER SIDE OF SMART ROADS

REFERENCE DRG. NO.

- LEGEND :-**
- V = PROPOSED SLUICE VALVE
 - PRV = PROPOSED PRESSURE REDUCING VALVE
 - AV = PROPOSED AIR VALVE
 - PL = PROPOSED PRESSURE LOGGERS
 - DMA = DISTRICT METREING AREA
 - ESR = ELEVATED SERVICE RESERVOIR
 - BFM = PROPOSED BULK FLOW METRE
 - Q = PROPOSED WATER QUALITY LOGGERS
- JUNCTION NO. / PRESSURE IN METRE HAZEN WILLIAMS CONSTANT(C) JUNCTION NO. / PRESSURE IN METRE
- DIAMETRE OF PIPE IN mm
- | 'C' VALUE | |
|-----------|----------------------|
| Value | EXISTING CI PIPES |
| 100 | EXISTING CI PIPES |
| 120 | EXISTING DI K7 PIPES |
| 140 | PROPOSED DI K9 PIPES |
- SMART ROAD
 - ABD AREA BOUNDARY
 - DMA BOUNDARY

WTE DRAWING FOR COMMENTS / APPROVAL

SIGNATURE _____ DATE _____

| | | | | | |
|------|----------|-------------|-------|------|------|
| 4 | | | | | |
| 3 | | | | | |
| 2 | | | | | |
| 1 | 20.07.18 | FOR TENDER | BR | GNG | MS |
| 0 | 30.06.18 | FOR TENDER | BR | GNG | MS |
| Rev. | Date | Description | Drawn | Chk. | App. |

File name :- WTE-2297-HI-ZONE 2 IMMEDIATE STAGE (2018).dwg

WTE Wadia Techno Engg. Services Ltd. Mumbai **Louis Berger**

Client: **SOLAPUR CITY DEVELOPMENT CORPORATION LTD.**

Project: **DESIGN, DEVELOP, MANAGE & IMPLEMENT URBAN INFRASTRUCTURE SERVICES PROJECTS UNDER SMART CITY MISSION (SCM) IN SOLAPUR CITY.**

Title: **IMPROVEMENT OF WATER DISTRIBUTION SYSTEM FOR DMA 2 (IMMEDIATE STAGE - 2018)**

North of Scale: **A 0 NTS** **WTE-2297** 00 W 2.02 R1 1 1

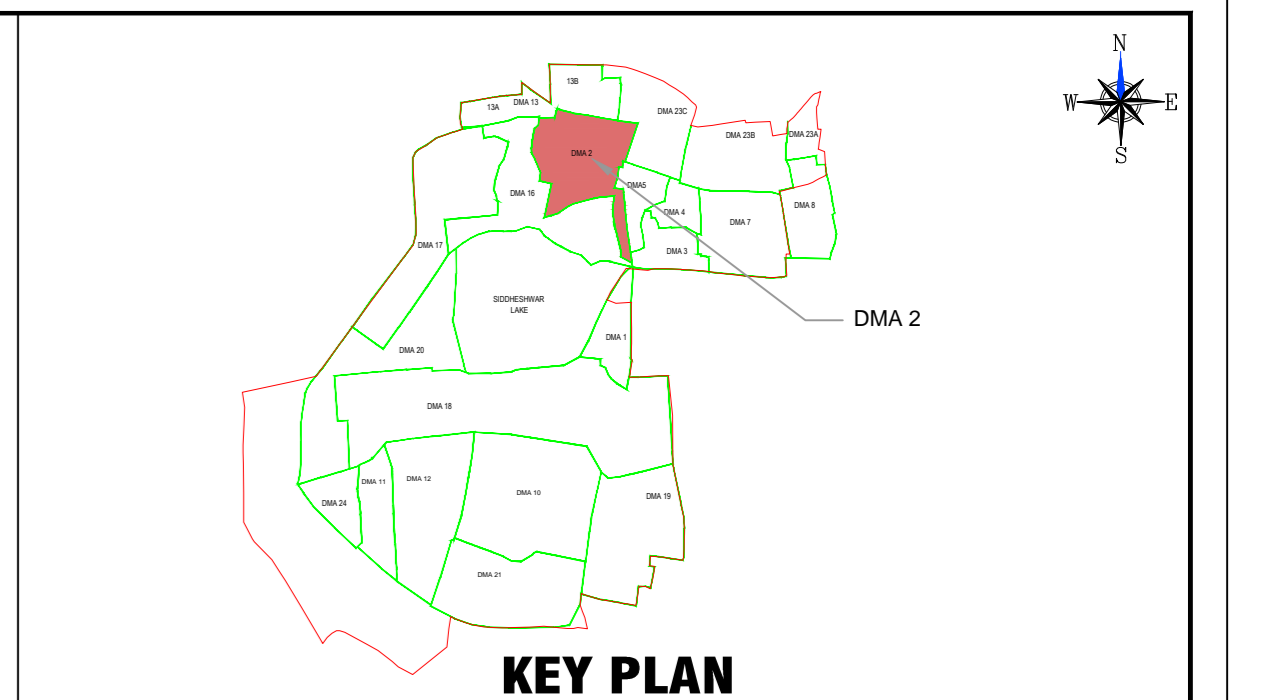
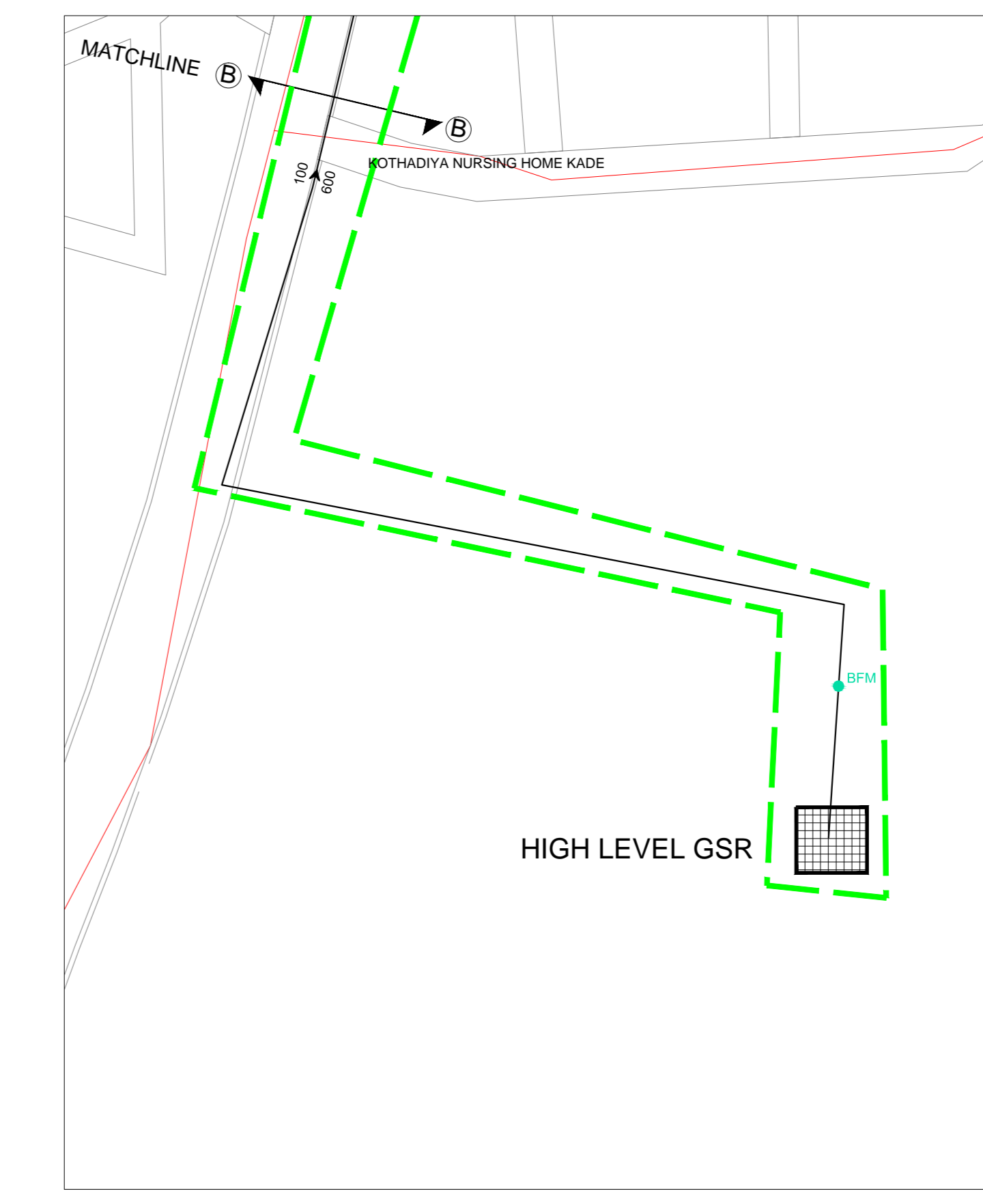
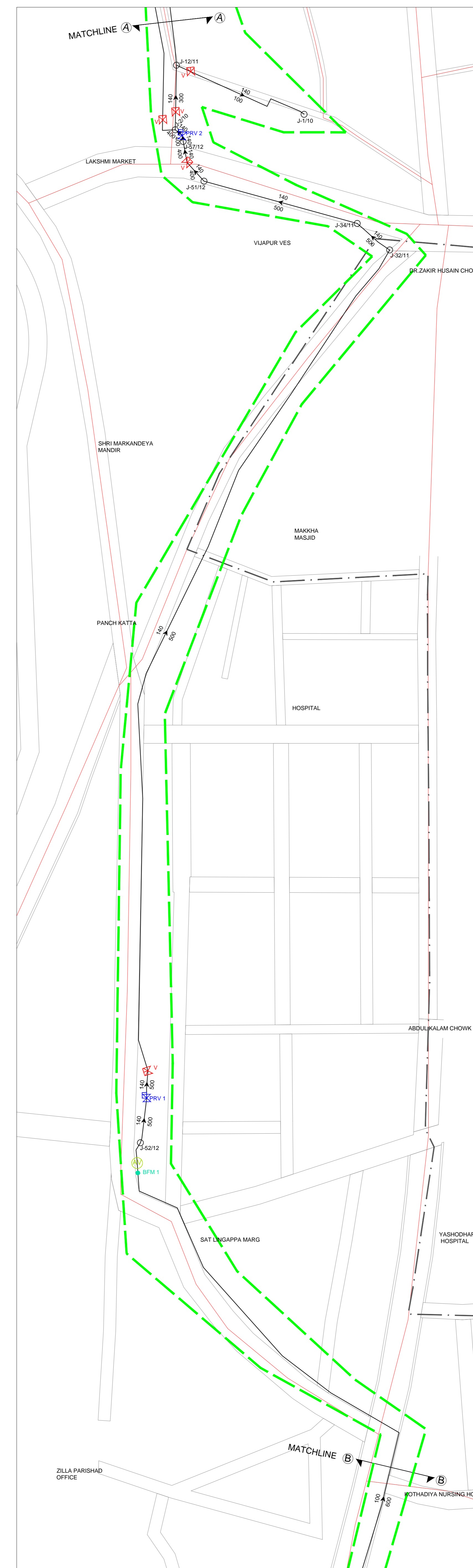
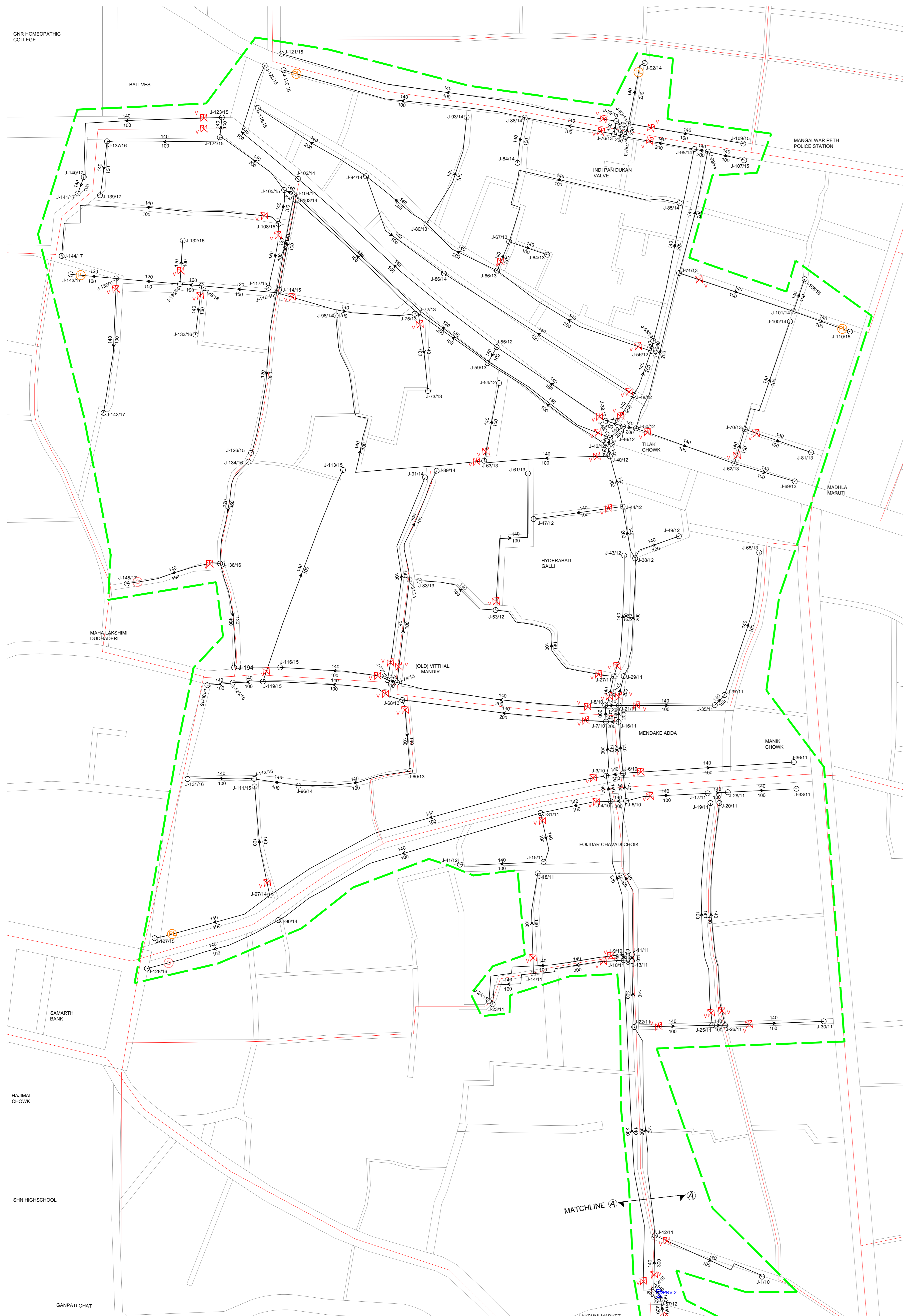

NOTES :-
 (A) DUE TO NO DEVELOPMENT IN FUTURE WATER PIPE LINE IS NOT PROPOSED ON OTHER SIDE OF SMART ROADS

REFERENCE DRG. NO.

LEGEND :-

- V = PROPOSED SLUICE VALVE
- PRV = PROPOSED PRESSURE REDUCING VALVE
- AV = PROPOSED AIR VALVE
- PL = PROPOSED PRESSURE LOGGERS
- DMA = DISTRICT METREING AREA
- ESR = ELEVATED SERVICE RESERVOIR
- BFM = PROPOSED BULK FLOW METRE
- Q = PROPOSED WATER QUALITY LOGGERS

JUNCTION NO. / PRESSURE IN METRE HAZEN WILLIAMS CONSTANT(C) JUNCTION NO. / PRESSURE IN METRE

| C' VALUE | |
|----------|----------------------|
| 100 | EXISTING CI PIPES |
| 120 | EXISTING DI K7 PIPES |
| 140 | PROPOSED DI K9 PIPES |

— SMART ROAD
 - - - ABD AREA BOUNDARY
 - - - DMA BOUNDARY

WTE DRAWING FOR COMMENTS / APPROVAL

SIGNATURE _____ DATE _____

| | | | | | |
|------|----------|-------------|--|-------|-----------|
| 4 | | | | | |
| 3 | | | | | |
| 2 | | | | | |
| 1 | 20.07.18 | FOR TENDER | | BR | GNG MS |
| 0 | 30.06.18 | FOR TENDER | | BR | GNG MS |
| Rev. | Date | Description | | Drawn | Clk. App. |

File name: WTE-2297-HZ-ZONE 2 ULTIMATE STAGE (2051).dwg

WTE Wadia Techno Engg. Services Ltd. Mumbai

Louis Berger

Client: SOLAPUR CITY DEVELOPMENT CORPORATION LTD.

Project: DESIGN, DEVELOP, MANAGE & IMPLEMENT URBAN INFRASTRUCTURE SERVICES PROJECTS UNDER SMART CITY MISSION (SCM) IN SOLAPUR CITY.

Title: IMPROVEMENT OF WATER DISTRIBUTION SYSTEM FOR DMA 2 (ULTIMATE STAGE - 2051) FOR ABD AREA

North of Scale: A 0 NTS WTE-2297 00 W 2.12 R1 1 1

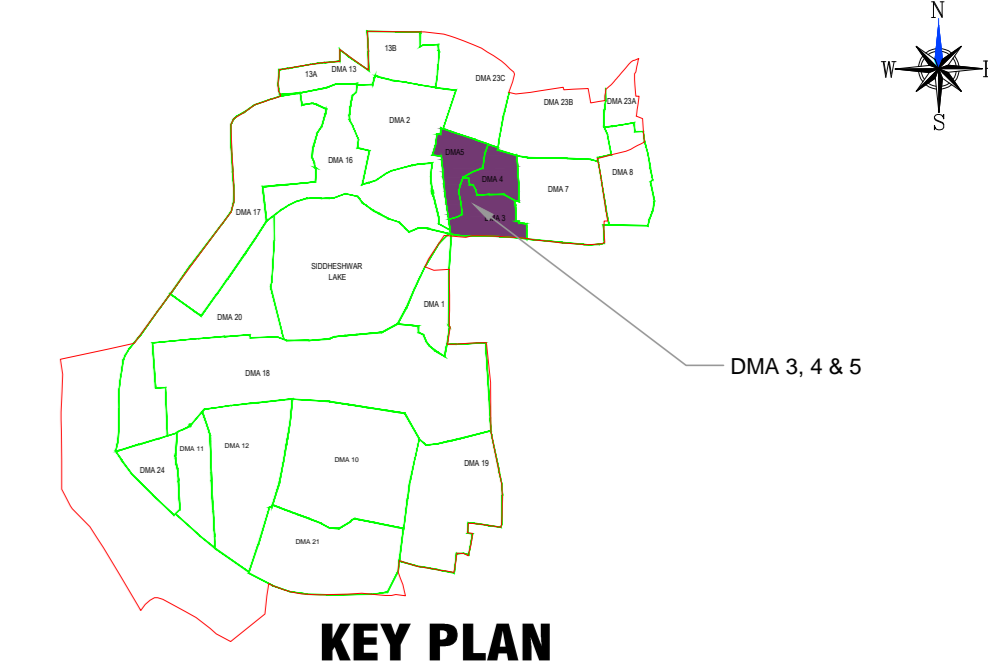
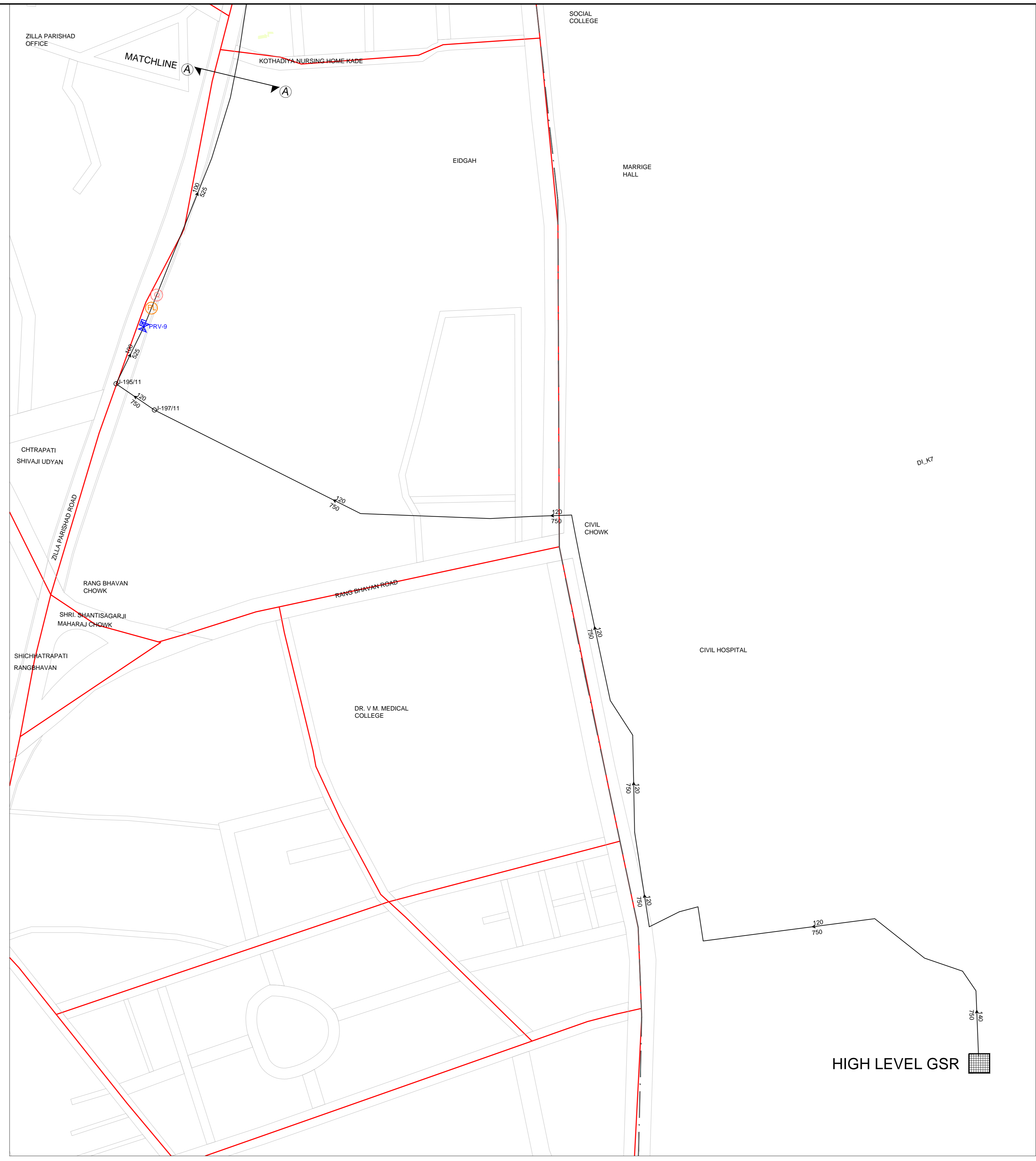
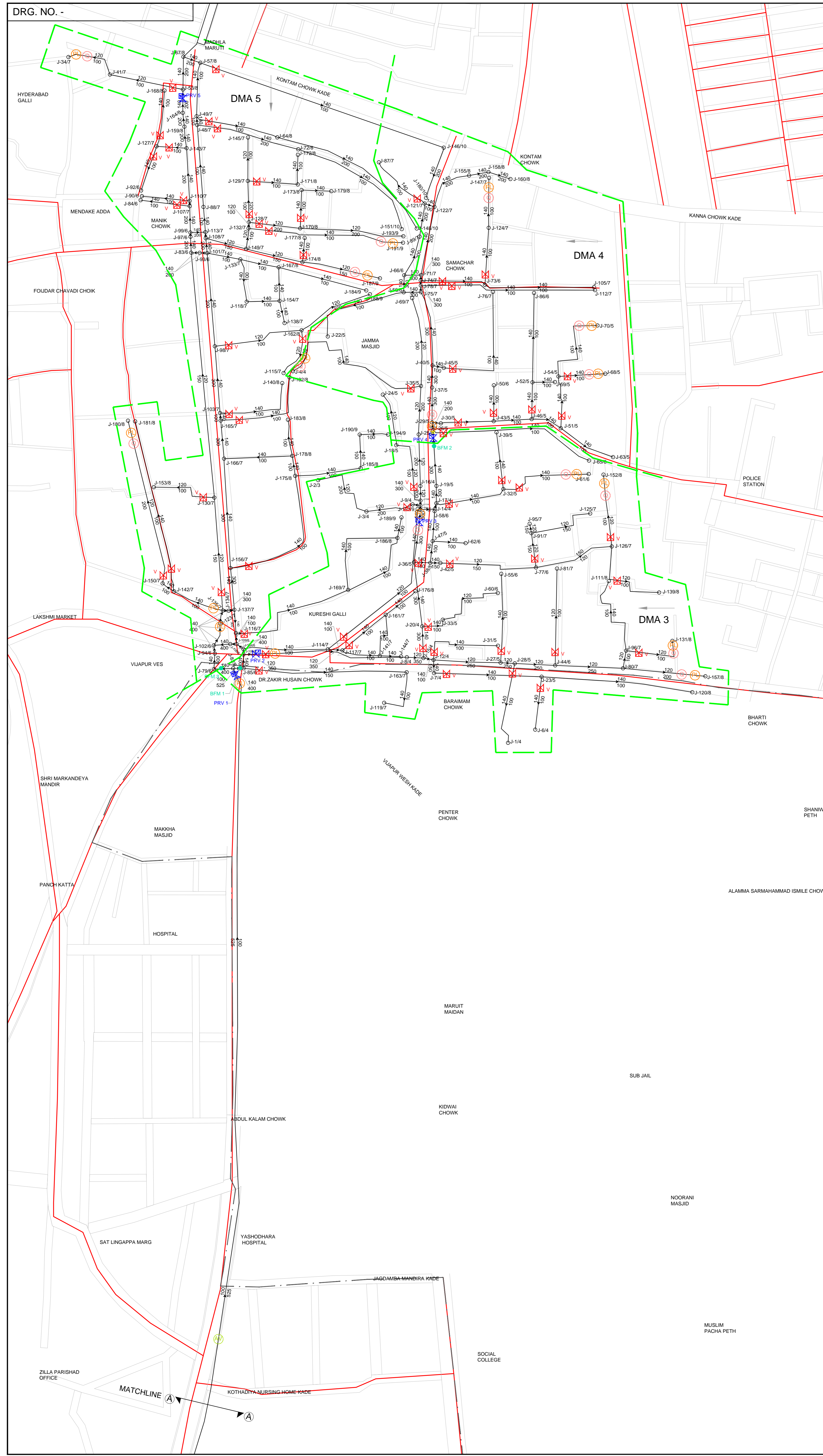

NOTES :-
 (A) DUE TO NO DEVELOPMENT IN FUTURE WATER PIPE LINE IS NOT PROPOSED ON OTHER SIDE OF SMART ROADS

REFERENCE DRG. NO.

LEGEND :-

- V = PROPOSED SLUICE VALVE
- PRV = PROPOSED PRESSURE REDUCING VALVE
- AV = PROPOSED AIR VALVE
- PL = PROPOSED PRESSURE LOGGERS
- DMA = DISTRICT METERING AREA
- ESR = ELEVATED SERVICE RESERVOIR
- BFM = PROPOSED BULK FLOW METRE
- Q = PROPOSED WATER QUALITY LOGGERS

JUNCTION NO. / PRESSURE IN METRE HAZEN-WILLIAMS CONSTANT(C) JUNCTION NO. / PRESSURE IN METRE

DIAMETRE OF PIPE IN mm

| 'C' VALUE |
|--------------------------|
| 100 EXISTING CI PIPES |
| 120 EXISTING DI K7 PIPES |
| 140 PROPOSED DI K9 PIPES |

— SMART ROAD
 --- ABD AREA BOUNDARY
 --- DMA BOUNDARY

For DMA 3

| Proposed Pipe DI K9 | |
|------------------------|---------------------|
| Diameter of pipe in mm | Length of pipe in M |
| 100mm | 1296 |
| 150mm | 173 |
| 200mm | 9 |
| 300mm | 214 |
| 400mm | 26 |
| Total Length | 1718 |

| Proposed Sluice Valve DI | |
|--------------------------------|-----------|
| Diameter of Sluice Valve in mm | Numbers |
| 100 | 17 |
| 150 | 4 |
| 200 | 1 |
| 300 | 1 |
| 350 | 1 |
| Total Numbers | 24 |

| Bulk Flow Meter | | | |
|-----------------|------------------------------|-----|---------------------------|
| Description | Diameter of Flow Meter in mm | Nos | Type of flow meter |
| BFM 1 | 150 | 1 | Electromagnetic full bore |

| Pressure Reducing Valve (PRV) | | | |
|-------------------------------|-----------------------|------------------------|-------------------------------|
| Description | Diameter of PRV in mm | Diameter of Pipe in mm | Initial Pressure Setting in M |
| PRV 2 | 200 | 300 | 6 4 12 13 |
| PRV 3 | 200 | 300 | 5 4 15 16 |
| PRV 5 | 200 | 300 | 8 8 16 17 |

| No of Pressure Loggers | |
|------------------------|---|
| No of Pressure Loggers | 7 |

| Air Valve (AV) | |
|-----------------------------|-----|
| Diameter of Air Valve in mm | Nos |
| 150 | 1 |

| Pressure Logger (Transmitter) | | | |
|-------------------------------|--------------|------------------|--------------------|
| Sr. No. | Tag No. | Near to Junction | Line Pressure in M |
| 1 | DMA-03-PL-01 | J-1201 | 8 |
| 2 | DMA-03-PL-02 | J-131 | 8 |
| 3 | DMA-03-PL-03 | J-152 | 8 |
| 4 | DMA-03-PL-04 | J-61 | 6 |
| 5 | DMA-03-PL-05 | J-10 | 4 |
| 6 | DMA-03-PL-06 | J-100 | 7 |
| 7 | DMA-03-PL-07 | J-195 | 11 |
| 8 | DMA-04-PL-01 | J-68 | 7 |
| 9 | DMA-04-PL-02 | J-7 | 7 |
| 10 | DMA-04-PL-03 | J-147 | 8 |
| 11 | DMA-04-PL-04 | J-4 | 4 |
| 12 | DMA-04-PL-05 | J-29 | 5 |
| 13 | DMA-05-PL-01 | J-123 | 8 |
| 14 | DMA-05-PL-02 | J-135 | 8 |
| 15 | DMA-05-PL-03 | J-180 | 9 |
| 16 | DMA-05-PL-04 | J-34 | 5 |
| 17 | DMA-05-PL-05 | J-191 | 10 |
| 18 | DMA-05-PL-06 | J-187 | 10 |

| Water Quality Logger | | | |
|----------------------|--------------|------------------|--------------------|
| Sr. No. | Tag No. | Near to Junction | Line Pressure in M |
| 1 | DMA-03-QA-01 | J-120 | 8 |
| 2 | DMA-03-QA-02 | J-131 | 8 |
| 3 | DMA-03-QA-03 | J-152 | 8 |
| 4 | DMA-03-QA-04 | J-61 | 6 |
| 5 | DMA-03-QA-05 | J-10 | 4 |
| 6 | DMA-03-QA-06 | J-195 | 11 |
| 7 | DMA-04-QA-01 | J-68 | 7 |
| 8 | DMA-04-QA-02 | J-7 | 7 |
| 9 | DMA-04-QA-03 | J-147 | 8 |
| 10 | DMA-04-QA-04 | J-4 | 4 |
| 11 | DMA-04-QA-05 | J-37 | 7 |
| 12 | DMA-05-QA-01 | J-180 | 9 |
| 13 | DMA-05-QA-02 | J-134 | 8 |
| 14 | DMA-05-QA-03 | J-191 | 10 |
| 15 | DMA-05-QA-04 | J-187 | 10 |

For DMA 4

| Proposed Pipe DI K9 | |
|------------------------|---------------------|
| Diameter of pipe in mm | Length of pipe in M |
| 100mm | 1229 |
| 150mm | 358 |
| 200mm | 177 |
| Total Length | 1664 |

| Proposed Sluice Valve DI | |
|--------------------------------|-----------|
| Diameter of Sluice Valve in mm | Numbers |
| 100 | 12 |
| 150 | - |
| 200 | - |
| 300 | - |
| Total Numbers | 12 |

| Bulk Flow Meter | | | |
|-----------------|------------------------------|-----|---------------------------|
| Description | Diameter of Flow Meter in mm | Nos | Type of flow meter |
| BFM 2 | 150 | 1 | Electromagnetic full bore |

| Pressure Reducing Valve (PRV) | | | |
|-------------------------------|-----------------------|------------------------|-------------------------------|
| Description | Diameter of PRV in mm | Diameter of Pipe in mm | Initial Pressure Setting in M |
| PRV 4 | 200 | 300 | 5 5 13 11 |

| No of Pressure Loggers | |
|------------------------|---|
| No of Pressure Loggers | 5 |

| No of Water Quantity Loggers | |
|------------------------------|---|
| No of Water Quantity Loggers | 5 |

| Flow Meter | | | |
|------------|--------------|------------------|--------------------|
| Sr. No. | Tag No. | Near to Junction | Line Pressure in M |
| 1 | DMA-03-FT-01 | J-82 | 8 |
| 2 | DMA-04-FT-01 | J-26 | 8 |
| 3 | DMA-05-FT-01 | J-102 | 10 |

For DMA 5

| Proposed Pipe DI K9 | |
|------------------------|---------------------|
| Diameter of pipe in mm | Length of pipe in M |
| 100mm | 2241 |
| 150mm | 98 |
| 200mm | 836 |
| 300mm | 10 |
| 400mm | 85 |
| Total Length | 3270 |

| Proposed Sluice Valve DI | |
|--------------------------------|-----------|
| Diameter of Sluice Valve in mm | Numbers |
| 100 | 12 |
| 150 | 2 |
| 200 | - |
| 300 | - |
| Total Numbers | 16 |

| Bulk Flow Meter | | | |
|-----------------|------------------------------|-----|---------------------------|
| Description | Diameter of Flow Meter in mm | Nos | Type of flow meter |
| BFM 3 | 150 | 1 | Electromagnetic full bore |

| Pressure Reducing Valve (PRV) | | | |
|-------------------------------|-----------------------|------------------------|-------------------------------|
| Description | Diameter of PRV in mm | Diameter of Pipe in mm | Initial Pressure Setting in M |
| PRV 1 | 400 | 525 | 11 6 11 12 |

| No of Pressure Loggers | |
|------------------------|---|
| No of Pressure Loggers | 6 |

| No of Water Quantity Loggers | |
|------------------------------|---|
| No of Water Quantity Loggers | 4 |

WTE DRAWING FOR COMMENTS / APPROVAL

SIGNATURE _____ DATE _____

| | | | | | |
|-----|----------|-------------|-------|------|--------|
| 4 | | | | | |
| 3 | | | | | |
| 2 | | | | | |
| 1 | 20.07.18 | FOR TENDER | | BR | GNG MS |
| 0 | 30.06.18 | FOR TENDER | | BR | GNG MS |
| Rev | Date | Description | Drawn | Chk. | App. |

Client: **Wadia Techno Engg. Services Ltd., Mumbai**

Client: **SOLAPUR CITY DEVELOPMENT CORPORATION LTD.**

Project: **DESIGN, DEVELOP, MANAGE & IMPLEMENT URBAN INFRASTRUCTURE SERVICES PROJECTS UNDER SMART CITY MISSION (SCM) IN SOLAPUR CITY**

Title: **IMPROVEMENT OF WATER DISTRIBUTION SYSTEM FOR DMA 3, 4 & 5 (HIGH LEVEL GSR) (IMMEDIATE STAGE - 2018) FOR ABD AREA**

North of Scale: **A0 NTS WTE-2297 00 W 2.03 R1 1 1**

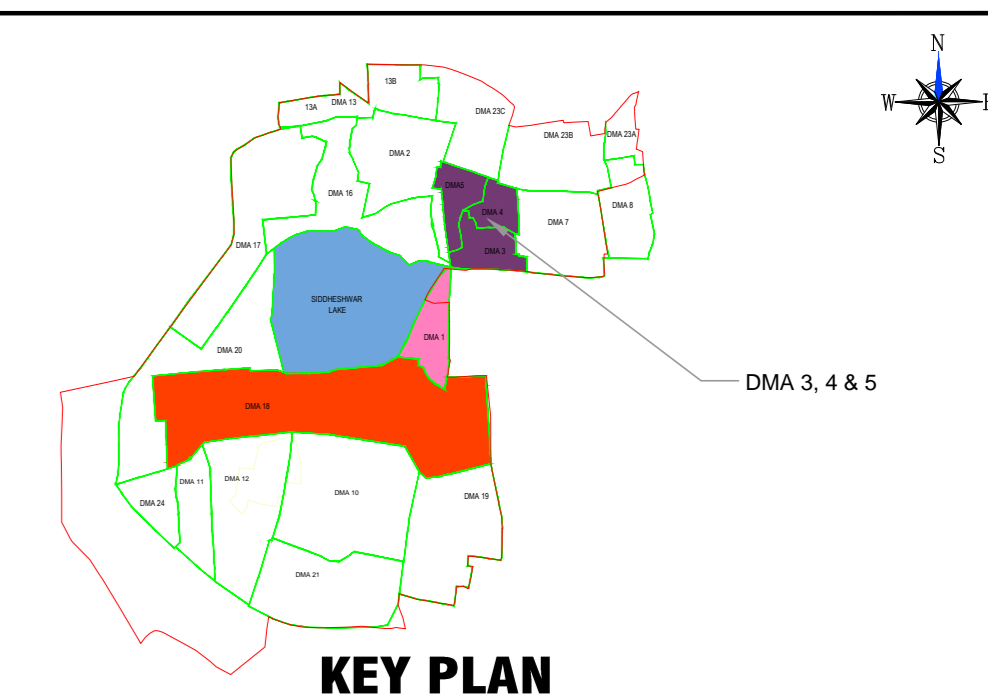
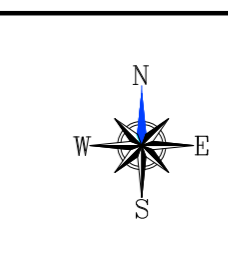
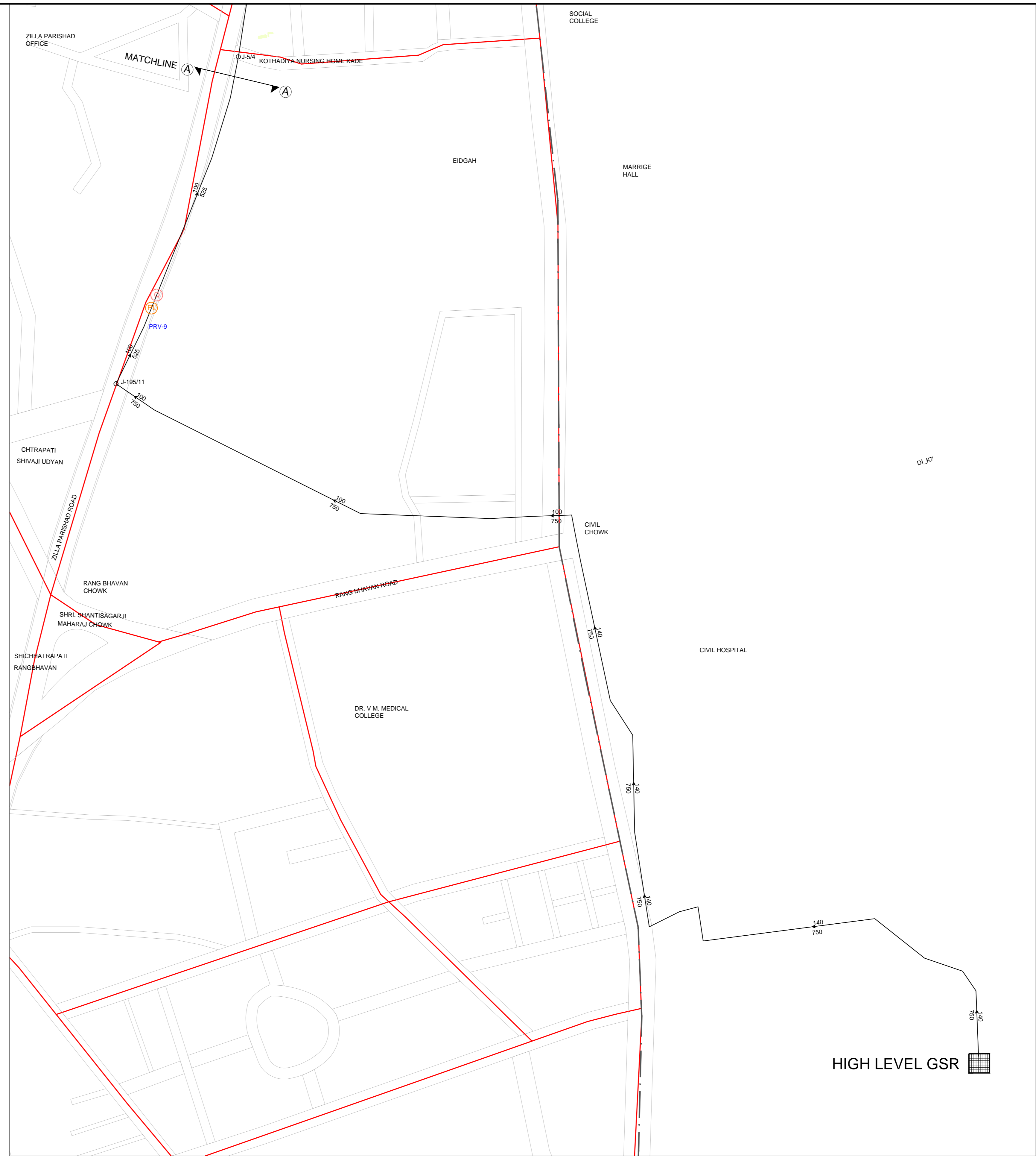
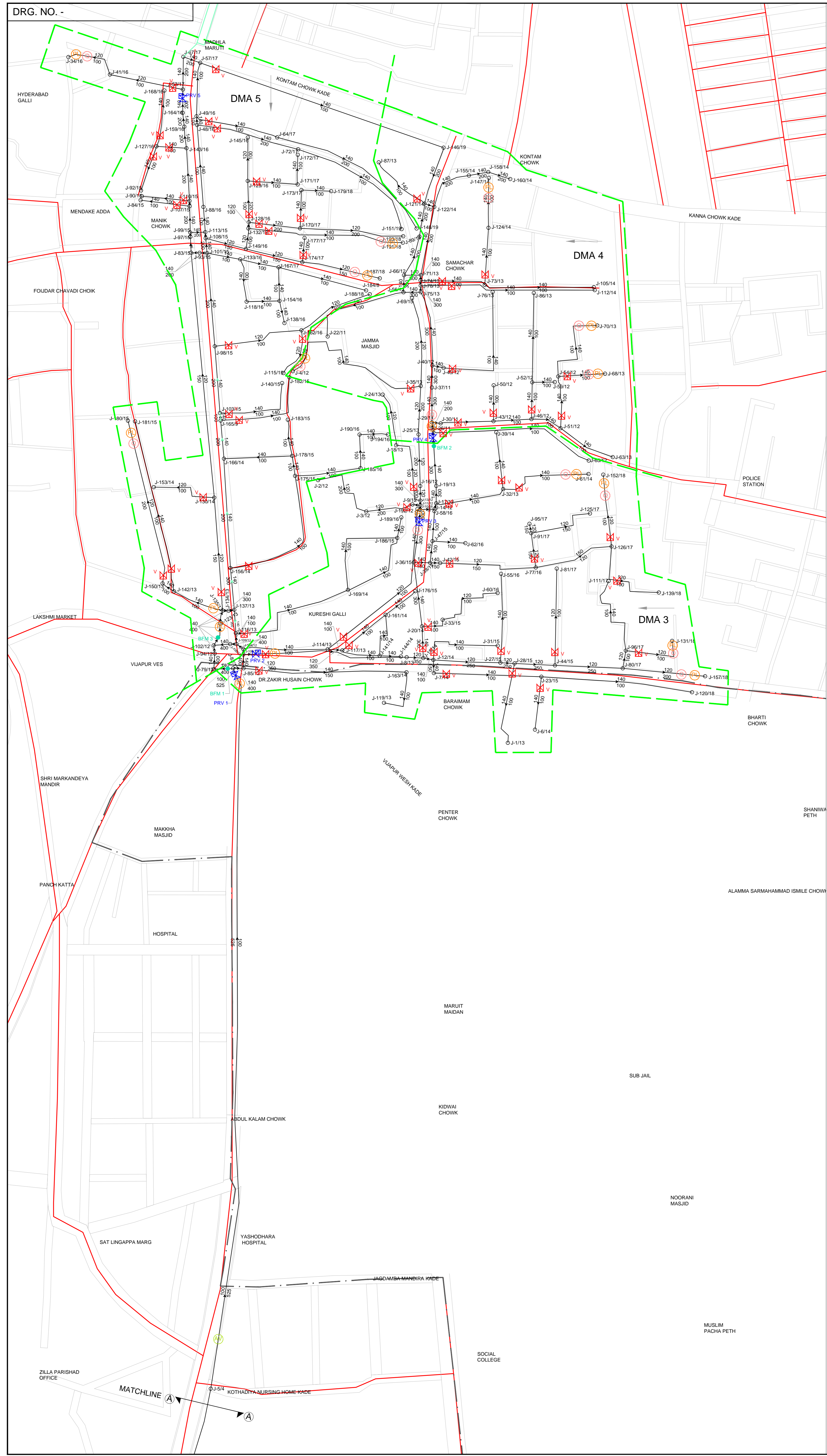

NOTES :-

- Ⓐ DUE TO NO DEVELOPMENT IN FUTURE WATER PIPE LINE IS NOT PROPOSED ON OTHER SIDE OF SMART ROADS

REFERENCE DRG. NO.

LEGEND :-

- V = PROPOSED SLUICE VALVE
- PRV = PROPOSED PRESSURE REDUCING VALVE
- AV = PROPOSED AIR VALVE
- PL = PROPOSED PRESSURE LOGGERS
- DMA = DISTRICT METREING AREA
- ESR = ELEVATED SERVICE RESERVOIR
- BFM = PROPOSED BULK FLOW METRE
- Q = PROPOSED WATER QUALITY LOGGERS

JUNCTION NO. / PRESSURE IN METRE DIAZEN WILLIAMS CONSTANT(C) JUNCTION NO. / PRESSURE IN METRE

| "C" VALUE | |
|-----------|----------------------|
| 100 | EXISTING CI PIPES |
| 120 | EXISTING DI KI PIPES |
| 140 | PROPOSED DI K9 PIPES |

- SMART ROAD
- - - ABD AREA BOUNDARY
- - - DMA BOUNDARY

WTE DRAWING FOR COMMENTS / APPROVAL

SIGNATURE _____ DATE _____

| | | | | | |
|-----|----------|-------------|-------|------|--------|
| 4 | | | | | |
| 3 | | | | | |
| 2 | | | | | |
| 1 | 20.07.18 | FOR TENDER | | BR | GNG MS |
| 0 | 30.06.18 | FOR TENDER | | BR | GNG MS |
| Rev | Date | Description | Drawn | Chk. | App. |

WTE Wadia Techno Engg. Services Ltd. Mumbai Louis Berger

Client: SOLAPUR CITY DEVELOPMENT CORPORATION LTD.
 Project: DESIGN, DEVELOP, MANAGE & IMPLEMENT URBAN INFRASTRUCTURE SERVICES PROJECTS UNDER SMART CITY MISSION (SCM) IN SOLAPUR CITY

Title: IMPROVEMENT OF WATER DISTRIBUTION SYSTEM FOR DMA 3, 4 & 5 (HIGH LEVEL GSR) (ULTIMATE STAGE - 2051) FOR ABD AREA

| | | | | | | | | |
|-------|---------|----------|------------|-------|------|-------|----|---|
| North | A 0 NTS | WTE-2297 | 00 | W | 2.13 | R1 | 1 | 1 |
| Scale | Job no. | Code | Discipline | Drawn | Rev. | Sheet | Of | |

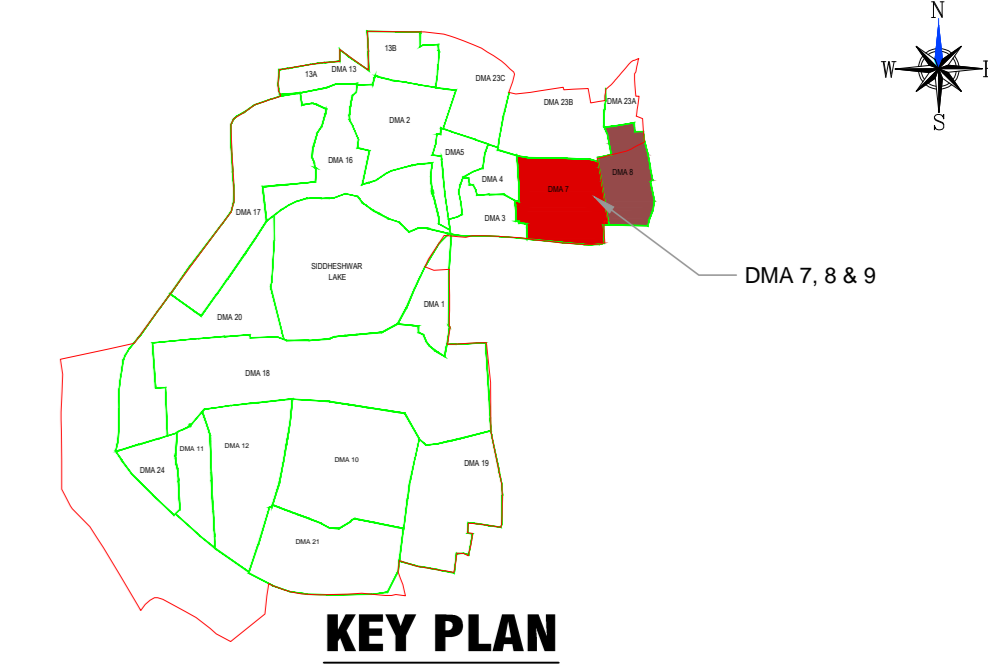
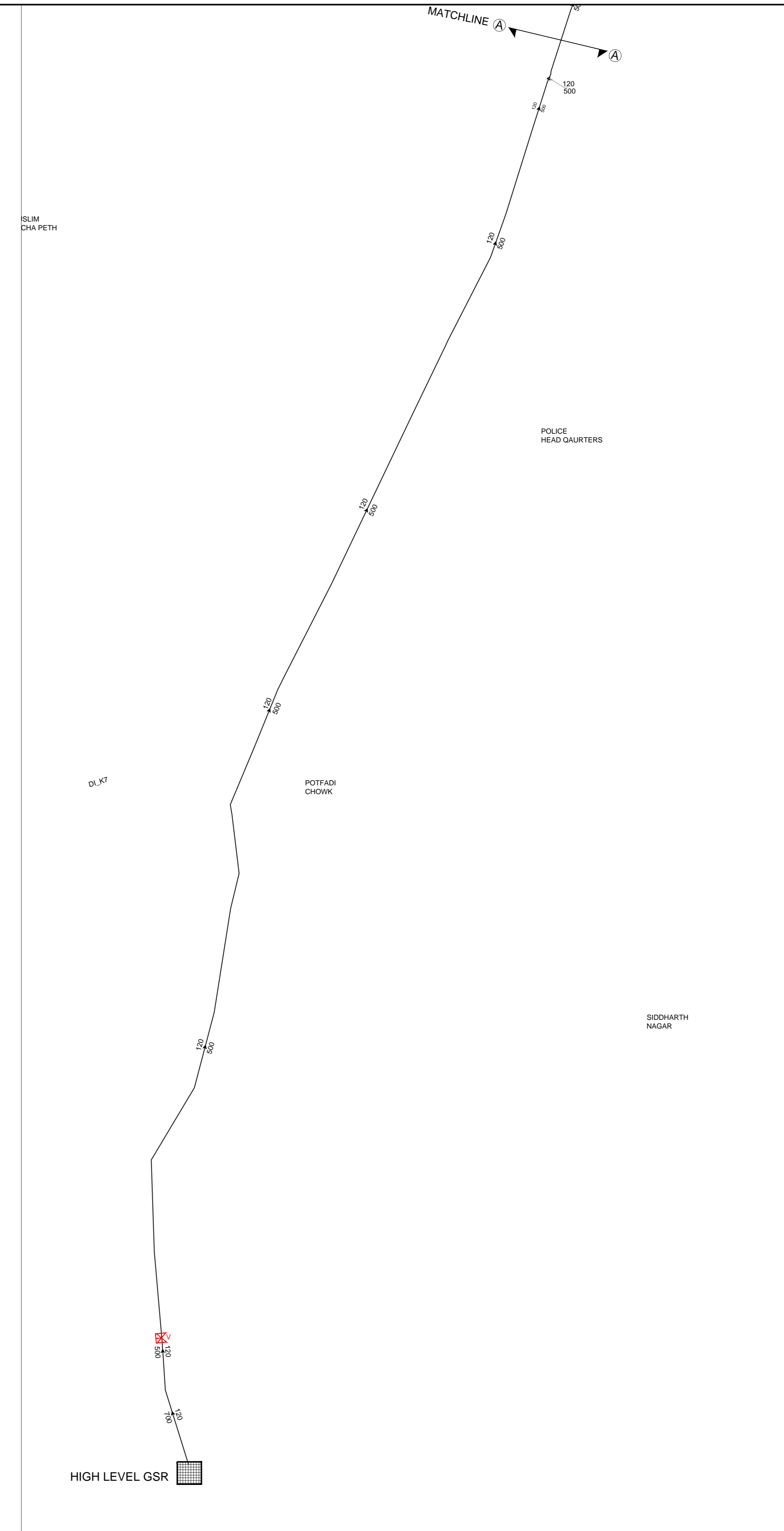
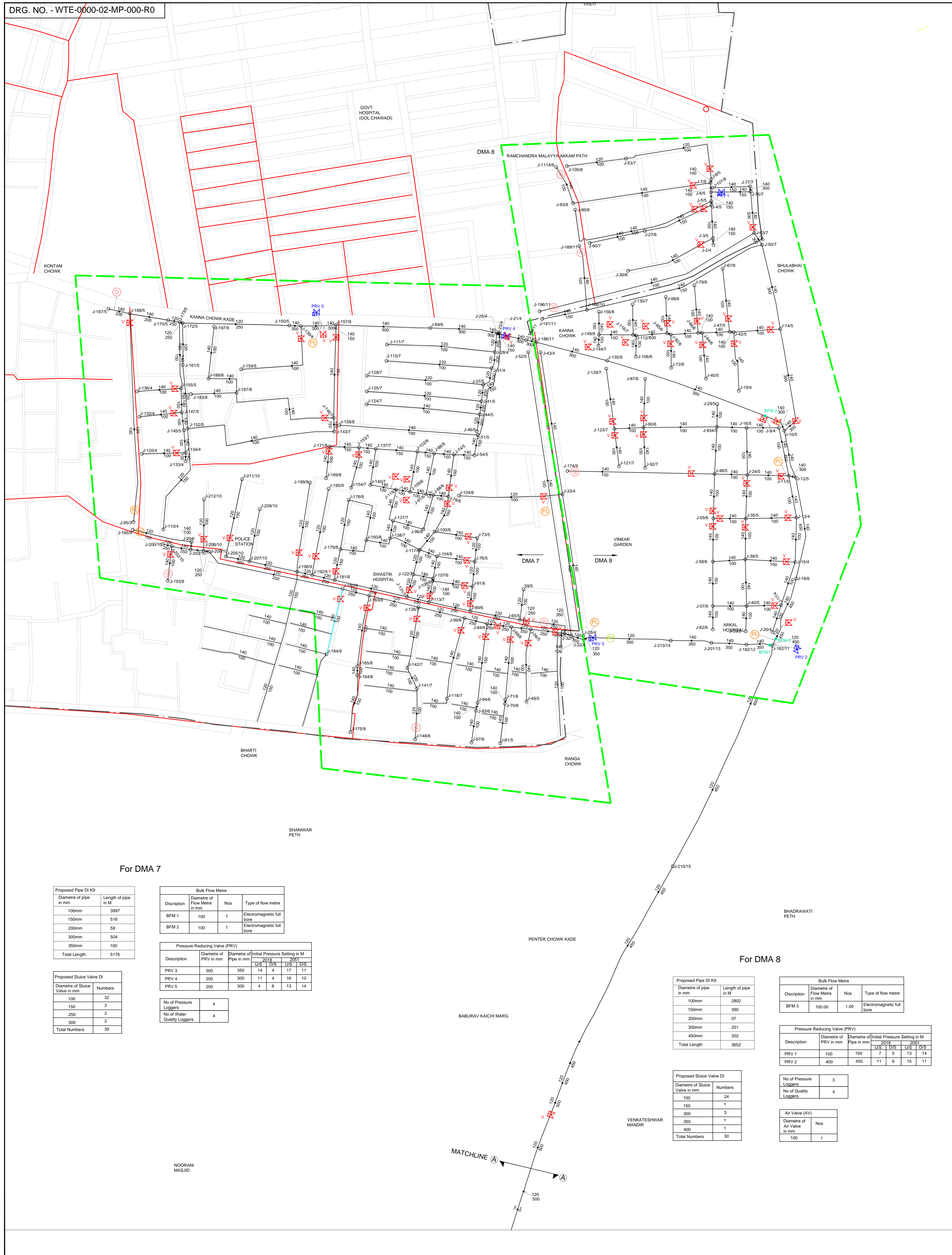

NOTES :-
 (A) DUE TO NO DEVELOPMENT IN FUTURE WATER PIPE LINE IS NOT PROPOSED ON OTHER SIDE OF SMART ROADS

REFERENCE DRG. NO.

- LEGEND :-**
- V = PROPOSED SLUICE VALVE
 - PRV = PROPOSED PRESSURE REDUCING VALVE
 - AV = PROPOSED AIR VALVE
 - PL = PROPOSED PRESSURE LOGGERS
 - DMA = DISTRICT METREING AREAS
 - ESR = ELEVATED SERVICE RESERVOIR
 - BFM = PROPOSED BULK FLOW METRE
 - Q = PROPOSED WATER QUALITY LOGGERS
- JUNCTION NO. / PRESSURE IN METRE HAZEN WILLIAM'S CONSTANT(C) JUNCTION NO. / PRESSURE IN METRE
- DIAMETRE OF PIPE IN mm
- | C' VALUE |
|--------------------------|
| 100 EXISTING CI PIPES |
| 120 EXISTING DI K7 PIPES |
| 140 PROPOSED DI K9 PIPES |
- SMART ROAD
- ABD AREA BOUNDARY
- DMA BOUNDARY

WTE DRAWING FOR COMMENTS / APPROVAL

SIGNATURE _____ DATE _____

| | | | | | |
|-----|----------|-------------|-------|------|--------|
| 4 | | | | | |
| 3 | | | | | |
| 2 | | | | | |
| 1 | 20.07.18 | FOR TENDER | | BR | GNG MS |
| 0 | 30.06.18 | FOR TENDER | | BR | GNG MS |
| Rev | Date | Description | Drawn | Clk. | App. |

File name :- WTE-2297-HI_ZONE 7.8.9 IMMEDIATE STAGE 2018.dwg

WTE Wadia Techno Engg. Services Ltd. Mumbai

Louis Berger

Client: SOLAPUR CITY DEVELOPMENT CORPORATION LTD.

Project: DESIGN, DEVELOP, MANAGE & IMPLEMENT URBAN INFRASTRUCTURE SERVICES PROJECTS UNDER SMART CITY MISSION (SCM) IN SOLAPUR CITY.

Title: IMPROVEMENT OF WATER DISTRIBUTION SYSTEM FOR DMA 7, 8 & 9 (HIGH LEVEL GSR) (IMMEDIATE STAGE - 2018) FOR ABD AREA

North of Scale: **A0 NTS WTE-2297** 00 W 2.04 R1 1 1

Scale: Job no. Code Discipline Drg. no. Rev. Sheet of

For DMA 7

| Proposed Pipe DI K9 | |
|------------------------|---------------------|
| Diameter of pipe in mm | Length of pipe in M |
| 100mm | 3997 |
| 150mm | 516 |
| 200mm | 59 |
| 300mm | 504 |
| 350mm | 100 |
| Total Length | 5176 |

| Bulk Flow Metre | | | |
|-----------------|------------------------------|-----|---------------------------|
| Description | Diameter of Flow Metre in mm | Nos | Type of flow metre |
| BFM 1 | 100 | 1 | Electromagnetic full bore |
| BFM 2 | 100 | 1 | Electromagnetic full bore |

| Pressure Reducing Valve (PRV) | | | | |
|-------------------------------|-----------------------|------------------------|-------------------------------|------------|
| Description | Diameter of PRV in mm | Diameter of Pipe in mm | Initial Pressure Setting in M | No. of PRV |
| | | | DS | DS |
| PRV 3 | 300 | 300 | 14 | 4 |
| PRV 4 | 200 | 300 | 11 | 4 |
| PRV 5 | 200 | 300 | 8 | 13 |

| Proposed Sluice Valve DI | |
|--------------------------------|---------|
| Diameter of Sluice Valve in mm | Numbers |
| 100 | 32 |
| 150 | 3 |
| 250 | 2 |
| 300 | 2 |
| Total Numbers | 39 |

| No. of Pressure Loggers | | | |
|------------------------------|-----|------|-----|
| Description | No. | Type | No. |
| No. of Pressure Loggers | 4 | | |
| No. of Water Quality Loggers | 4 | | |

For DMA 8

| Proposed Pipe DI K9 | |
|------------------------|---------------------|
| Diameter of pipe in mm | Length of pipe in M |
| 100mm | 2602 |
| 150mm | 300 |
| 200mm | 07 |
| 300mm | 251 |
| 400mm | 202 |
| Total Length | 3662 |

| Bulk Flow Metre | | | |
|-----------------|------------------------------|------|---------------------------|
| Description | Diameter of Flow Metre in mm | Nos | Type of flow metre |
| BFM 3 | 100.00 | 1.00 | Electromagnetic full bore |

| Pressure Reducing Valve (PRV) | | | | |
|-------------------------------|-----------------------|------------------------|-------------------------------|------------|
| Description | Diameter of PRV in mm | Diameter of Pipe in mm | Initial Pressure Setting in M | No. of PRV |
| | | | DS | DS |
| PRV 1 | 100 | 150 | 7 | 5 |
| PRV 2 | 400 | 450 | 11 | 6 |

| Proposed Sluice Valve DI | |
|--------------------------------|---------|
| Diameter of Sluice Valve in mm | Numbers |
| 100 | 24 |
| 150 | 1 |
| 300 | 3 |
| 400 | 1 |
| Total Numbers | 30 |

| No. of Pressure Loggers | |
|-------------------------|-----|
| Description | No. |
| No. of Pressure Loggers | 3 |
| No. of Quality Loggers | 4 |

| Air Valve (AV) | |
|-----------------------------|-----|
| Diameter of Air Valve in mm | Nos |
| 100 | 1 |

| Pressure Logger (Transmitter) | | | |
|-------------------------------|--------------|------------------|--------------------|
| Sl. No. | Tag No. | Near to Junction | Line Pressure in M |
| 1 | DMA-07-PL-01 | J-146 | 8 |
| 2 | DMA-07-PL-02 | J-68 | 7 |
| 3 | DMA-07-PL-03 | J-109 | 8 |
| 4 | DMA-07-PL-04 | J-4 | 3 |
| 5 | DMA-08-PL-01 | J-1 | 3 |
| 6 | DMA-08-PL-02 | J-206 | 15 |
| 7 | DMA-08-PL-03 | J-64 | 6 |

| Water Quality Logger | | |
|----------------------|--------------|------------------|
| Sl. No. | Tag No. | Near to Junction |
| 1 | DMA-07-QA-01 | J-142 |
| 2 | DMA-07-QA-02 | J-148 |
| 3 | DMA-07-QA-03 | J-75 |
| 4 | DMA-07-QA-04 | J-17 |
| 5 | DMA-08-QA-01 | J-199 |
| 6 | DMA-08-QA-02 | J-204 |
| 7 | DMA-08-QA-03 | J-201 |
| 8 | DMA-08-QA-04 | J-189 |

| Flow Metre | | |
|------------|--------------|------------------|
| Sl. No. | Tag No. | Near to Junction |
| 1 | DMA-07-FT-01 | J-1 |
| 2 | DMA-07-FT-02 | J-203 |
| 3 | DMA-08-FT-01 | J-206 |

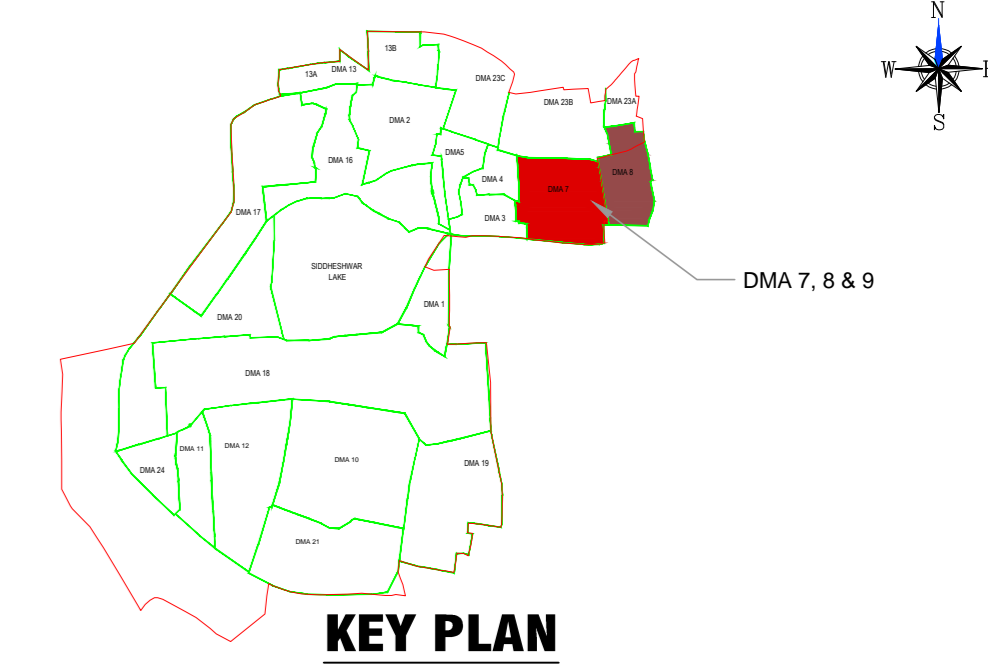
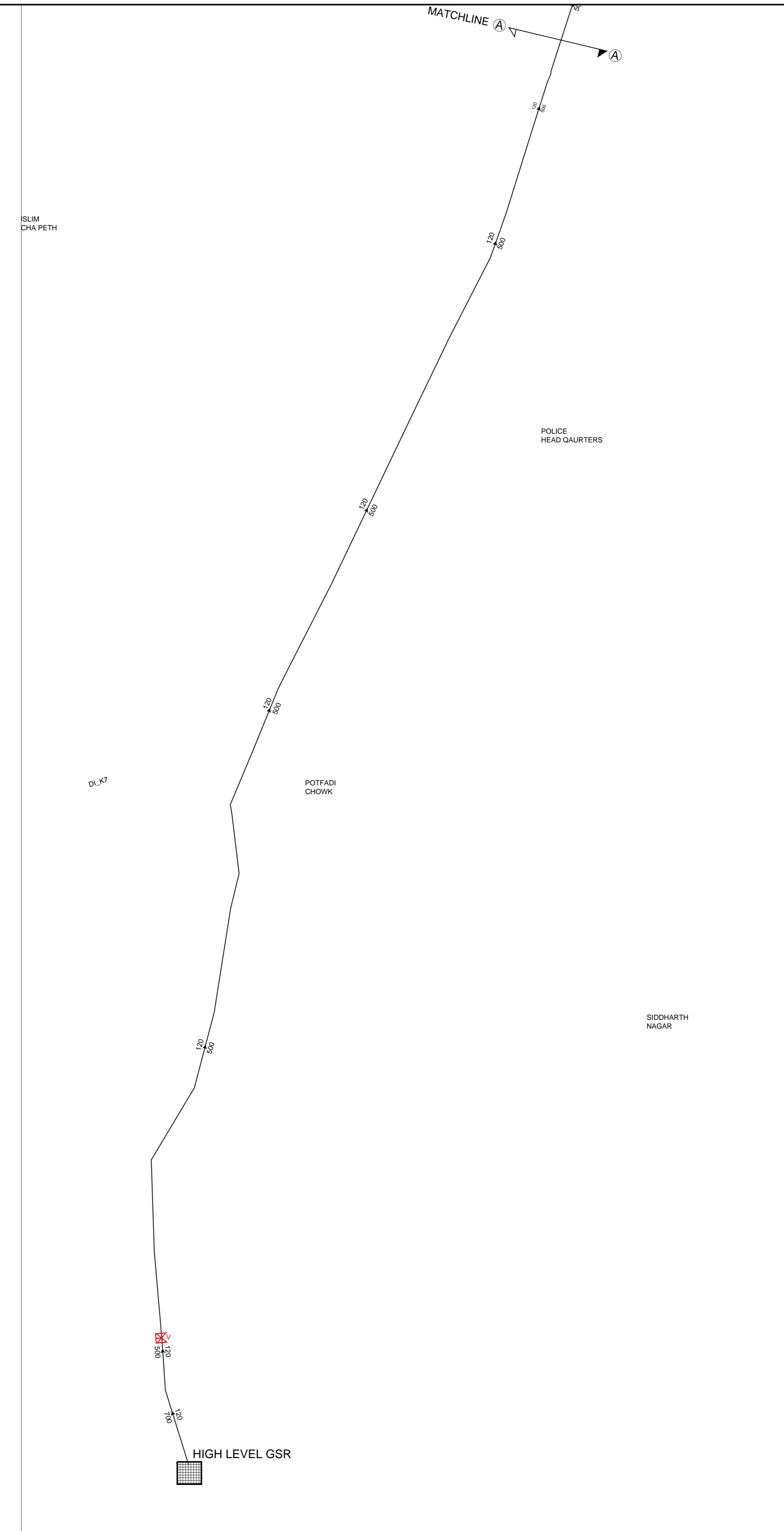
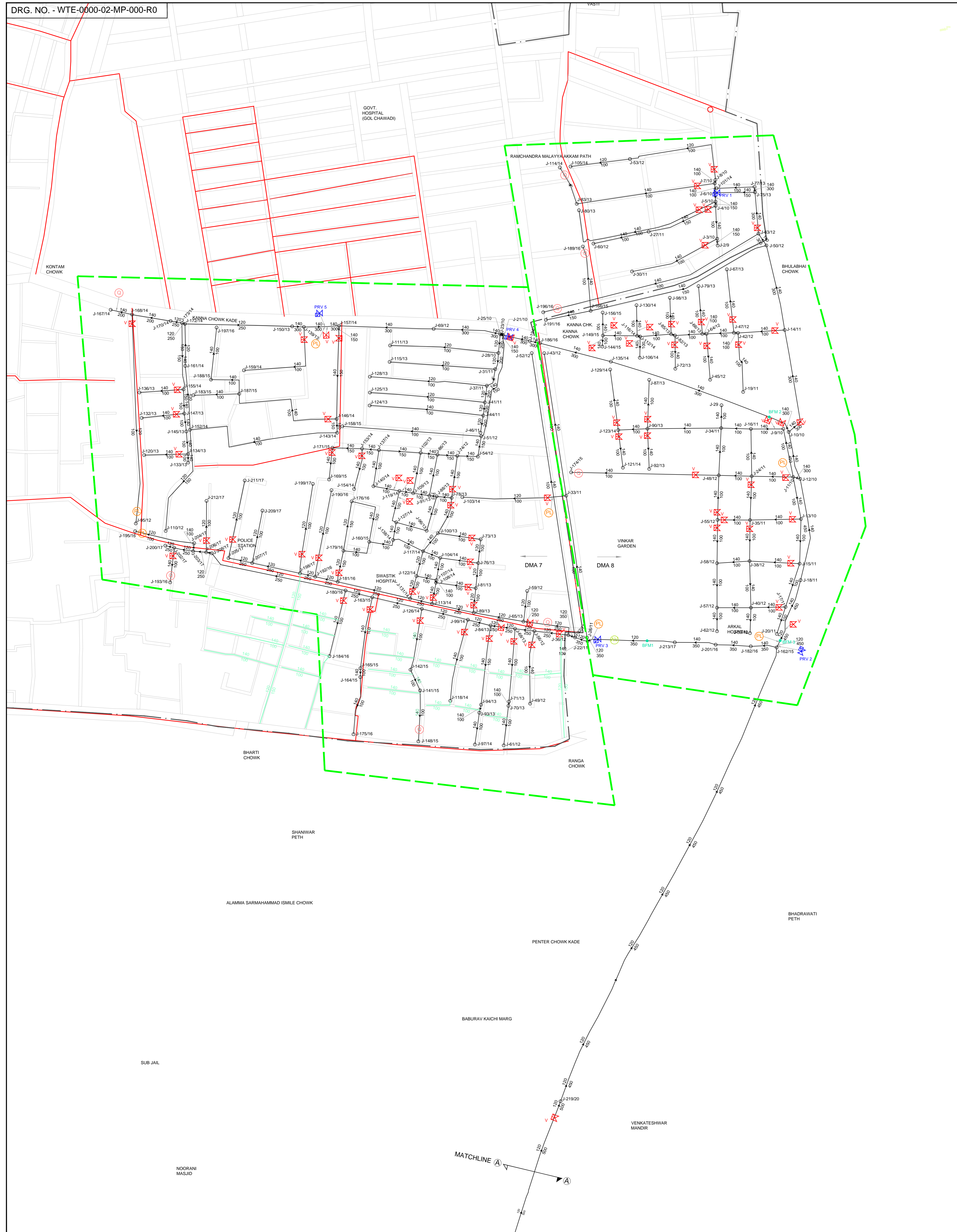

NOTES :-
 (A) DUE TO NO DEVELOPMENT IN FUTURE WATER PIPE LINE IS NOT PROPOSED ON OTHER SIDE OF SMART ROADS

REFERENCE DRG. NO.

- LEGEND :-**
- V = PROPOSED SLUICE VALVE
 - PRV = PROPOSED PRESSURE REDUCING VALVE
 - AV = PROPOSED AIR VALVE
 - PL = PROPOSED PRESSURE LOGGERS
 - DMA = DISTRICT METREING AREA
 - ESR = ELEVATED SERVICE RESERVOIR
 - BFM = PROPOSED BULK FLOW METRE
 - Q = PROPOSED WATER QUALITY LOGGERS
- JUNCTION NO. / PRESSURE IN METRE HAZEN WILLIAMS CONSTANT(C) JUNCTION NO. / PRESSURE IN METRE
- DIAMETRE OF PIPE IN mm
- | 'C' VALUE | |
|-----------|----------------------|
| 100 | EXISTING CI PIPES |
| 120 | EXISTING DI KI PIPES |
| 140 | PROPOSED DI K9 PIPES |
- SMART ROAD
 - ABD AREA BOUNDARY
 - DMA BOUNDARY

WTE DRAWING FOR COMMENTS / APPROVAL

SIGNATURE _____ DATE _____

| | | | | | |
|-----|----------|-------------|-------|------|------|
| 4 | | | | | |
| 3 | | | | | |
| 2 | | | | | |
| 1 | 20.07.18 | FOR TENDER | BR | GNG | MS |
| 0 | 30.06.18 | FOR TENDER | BR | GNG | MS |
| Rev | Date | Description | Drawn | Chk. | App. |

File name : WTE-2297-HI-ZONE 7&8 ULTIMATE STAGE (2051).dwg

WTE Wadia Techno Eng. Services Ltd. Mumbai

Louis Berger

Client: SOLAPUR CITY DEVELOPMENT CORPORATION LTD.

Project: DESIGN, DEVELOP, MANAGE & IMPLEMENT URBAN INFRASTRUCTURE SERVICES PROJECTS UNDER SMART CITY MISSION (SCM) IN SOLAPUR CITY.

Title: IMPROVEMENT OF WATER DISTRIBUTION SYSTEM FOR DMA 7, 8 & 9 (HIGH LEVEL GSR) (ULTIMATE STAGE - 2051) FOR ABD AREA

North of Scale: **A 0 NTS** **WTE-2297** 00 W 2.14 R1 1 1

Scale Job no. Code Discipline Design Rev. Sheet Of

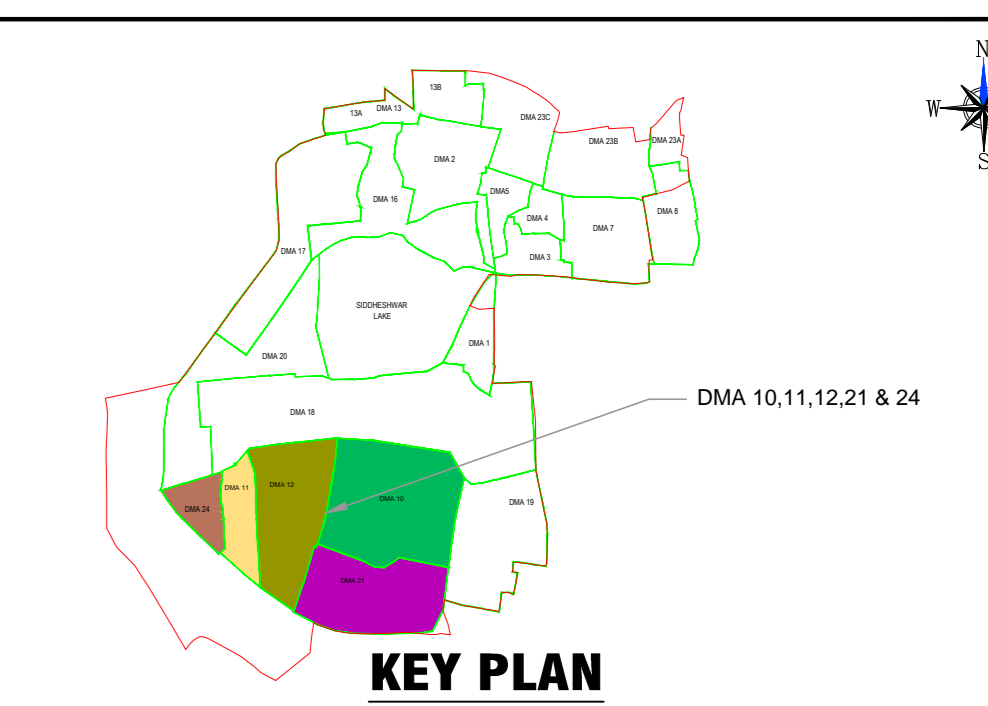
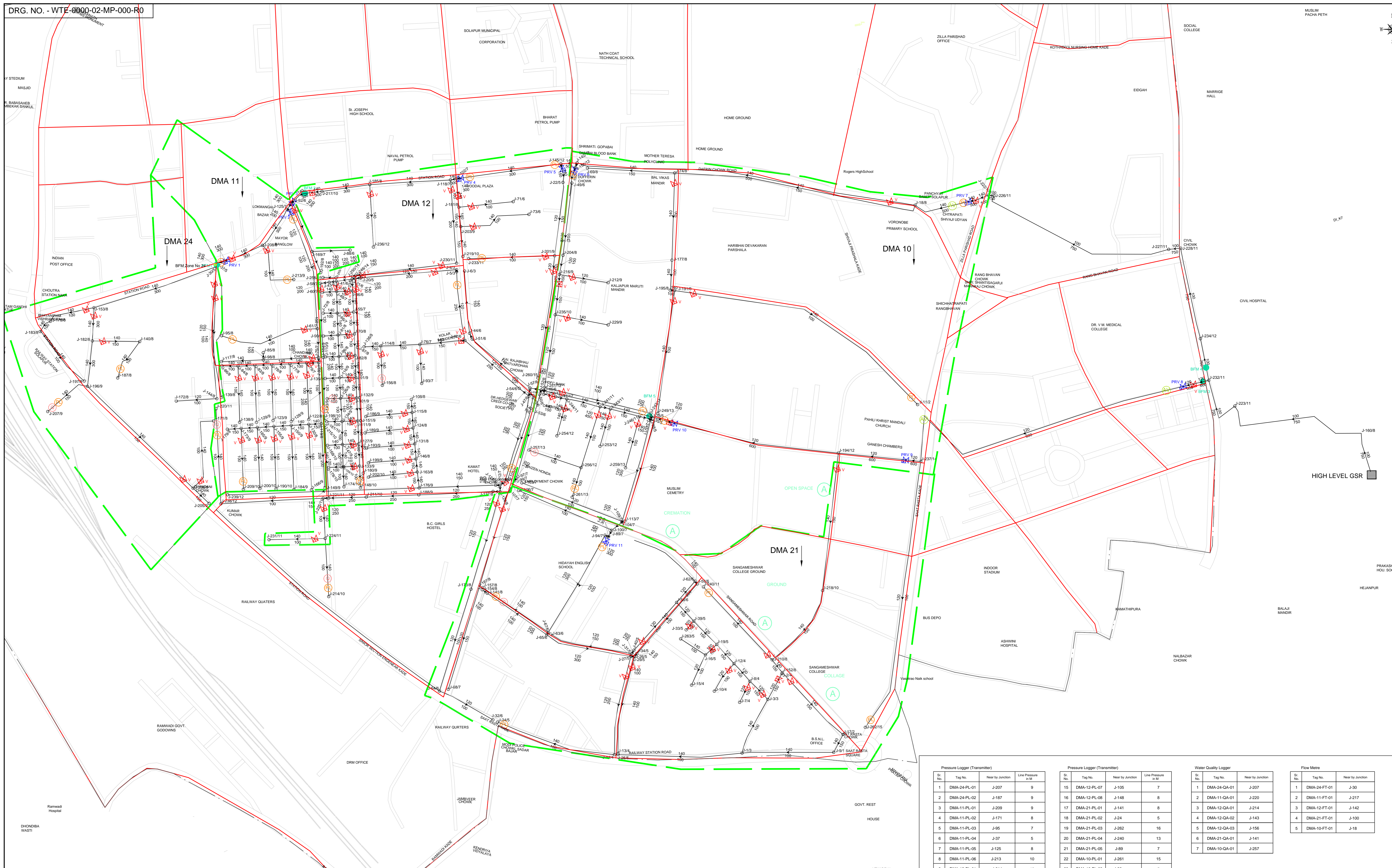

NOTES :-
 (A) DUE TO NO DEVELOPMENT IN FUTURE WATER PIPE LINE IS NOT PROPOSED ON OTHER SIDE OF SMART ROADS

REFERENCE DRG. NO.



LEGEND :-

| JUNCTION NO. / PRESSURE | HAZEN WILLIAMS CONSTANT (C) | JUNCTION NO. / PRESSURE | DIAMETRE OF PIPE IN mm |
|-------------------------|-----------------------------|-------------------------|------------------------|
| 100 | EXISTING CI PIPES | | |
| 120 | EXISTING DI K7 PIPES | | |
| 140 | PROPOSED DI K9 PIPES | | |

— SMART ROAD
 - - - ABD AREA BOUNDARY
 - - - DMA BOUNDARY

| Sl. No. | Tag No. | Near by Junction | Line Pressure (M) |
|---------|--------------|------------------|-------------------|
| 1 | DMA-24-PL-01 | J-207 | 9 |
| 2 | DMA-24-PL-02 | J-187 | 9 |
| 3 | DMA-11-PL-01 | J-209 | 9 |
| 4 | DMA-11-PL-02 | J-171 | 8 |
| 5 | DMA-11-PL-03 | J-95 | 7 |
| 6 | DMA-11-PL-04 | J-37 | 5 |
| 7 | DMA-11-PL-05 | J-125 | 8 |
| 8 | DMA-11-PL-06 | J-213 | 10 |
| 9 | DMA-12-PL-01 | J-214 | 10 |
| 10 | DMA-12-PL-02 | J-198 | 9 |
| 11 | DMA-12-PL-03 | J-102 | 7 |
| 12 | DMA-12-PL-04 | J-145 | 8 |
| 13 | DMA-12-PL-05 | J-233 | 11 |
| 14 | DMA-12-PL-06 | J-6 | 3 |

| Sl. No. | Tag No. | Near by Junction | Line Pressure (M) |
|---------|--------------|------------------|-------------------|
| 15 | DMA-12-PL-07 | J-105 | 7 |
| 16 | DMA-12-PL-08 | J-148 | 8 |
| 17 | DMA-21-PL-01 | J-141 | 8 |
| 18 | DMA-21-PL-02 | J-24 | 5 |
| 19 | DMA-21-PL-03 | J-262 | 16 |
| 20 | DMA-21-PL-04 | J-240 | 13 |
| 21 | DMA-21-PL-05 | J-99 | 7 |
| 22 | DMA-10-PL-01 | J-261 | 15 |
| 23 | DMA-10-PL-02 | J-28 | 5 |
| 24 | DMA-10-PL-03 | J-242 | 13 |
| 25 | DMA-10-PL-04 | J-158 | 8 |
| 26 | DMA-10-PL-05 | J-11 | 4 |
| 27 | DMA-10-PL-06 | J-222 | 11 |

| Sl. No. | Tag No. | Near by Junction |
|---------|--------------|------------------|
| 1 | DMA-24-QA-01 | J-207 |
| 2 | DMA-11-QA-01 | J-220 |
| 3 | DMA-12-QA-01 | J-214 |
| 4 | DMA-12-QA-02 | J-143 |
| 5 | DMA-12-QA-03 | J-156 |
| 6 | DMA-21-QA-01 | J-141 |
| 7 | DMA-10-QA-01 | J-257 |

| Sl. No. | Tag No. | Near by Junction |
|---------|--------------|------------------|
| 1 | DMA-24-FT-01 | J-300 |
| 2 | DMA-11-FT-01 | J-217 |
| 3 | DMA-12-FT-01 | J-142 |
| 4 | DMA-21-FT-01 | J-100 |
| 5 | DMA-10-FT-01 | J-18 |

WTE DRAWING FOR COMMENTS / APPROVAL
 SIGNATURE: _____ DATE: _____

For DMA 24

| Proposed Pipe DI K9 | Diameter of pipe in mm | Length of pipe in M |
|---------------------|------------------------|---------------------|
| 100mm | 409 | |
| 150mm | 422 | |
| 300mm | 320 | |
| 300mm | 198 | |
| Total Length | 1161 | |

| Bulk Flow metre | | | |
|-----------------|------------------------|-----|---------------------------|
| Description | Diameter of Pipe in mm | Nos | Type of flow metre |
| BFM 1 | 100 | 1 | Electromagnetic full bore |

| Pressure Reducing Valve (PRV) | | | |
|-------------------------------|-----------------------|---|------------------------|
| Description | Diameter of PRV in mm | Diameter of Initial Pressure Setting in M | Diameter of Pipe in mm |
| PRV 1 | 250 | 300 | 8 5 11 8 |

| Proposed Sluice Valve DI | |
|--------------------------------|--------------|
| Diameter of Sluice Valve in mm | Numbers |
| 100 | 11 |
| 150 | 1 |
| 250 | 1 |
| Total Numbers | 13.00 |

| No of Pressure Loggers | |
|------------------------|----------|
| 250 | 1 |
| Total Numbers | 1 |

For DMA 11

| Proposed Pipe DI K9 | Diameter of pipe in mm | Length of pipe in M |
|---------------------|------------------------|---------------------|
| 100mm | 1583 | |
| 150mm | 150 | |
| 200mm | 452 | |
| 300mm | 198 | |
| Total Length | 2383 | |

| Bulk Flow metre | | | |
|-----------------|------------------------|-----|---------------------------|
| Description | Diameter of Pipe in mm | Nos | Type of flow metre |
| BFM 2 | 150 | 1 | Electromagnetic full bore |

| Pressure Reducing Valve (PRV) | | | |
|-------------------------------|-----------------------|---|------------------------|
| Description | Diameter of PRV in mm | Diameter of Initial Pressure Setting in M | Diameter of Pipe in mm |
| PRV 2 | 150 | 200 | 7 7 10 11 |
| PRV 3 | 200 | 300 | 10 6 13 9 |

| Proposed Sluice Valve DI | |
|--------------------------------|-----------|
| Diameter of Sluice Valve in mm | Numbers |
| 100 | 14 |
| 150 | 2 |
| 250 | 1 |
| 300 | 1 |
| Total Numbers | 16 |

| No of Pressure Loggers | |
|------------------------|----------|
| 150 | 6 |
| Total Numbers | 6 |

| No of Water Quantity Loggers | |
|------------------------------|----------|
| 150 | 1 |
| Total Numbers | 1 |

For DMA 12

| Proposed Pipe DI K9 | Diameter of pipe in mm | Length of pipe in M |
|---------------------|------------------------|---------------------|
| 100mm | 2476 | |
| 150mm | 99 | |
| 300mm | 33 | |
| Total Length | 3607 | |

| Bulk Flow metre | | | |
|-----------------|------------------------|-----|---------------------------|
| Description | Diameter of Pipe in mm | Nos | Type of flow metre |
| BFM 5 | 150 | 1 | Electromagnetic full bore |

| Pressure Reducing Valve (PRV) | | | |
|-------------------------------|-----------------------|---|------------------------|
| Description | Diameter of PRV in mm | Diameter of Initial Pressure Setting in M | Diameter of Pipe in mm |
| PRV 8 | 500 | 600 | 14 12 17 15 |
| PRV 10 | 400 | 600 | 12 5 18 10 |

| Proposed Sluice Valve DI | |
|--------------------------------|-----------|
| Diameter of Sluice Valve in mm | Numbers |
| 100 | 18 |
| 150 | 4 |
| 200 | 3 |
| 250 | 2 |
| 300 | 1 |
| Total Numbers | 28 |

| No of Pressure Loggers | |
|------------------------|----------|
| 500 | 8 |
| Total Numbers | 8 |

| No of Water Quantity Loggers | |
|------------------------------|----------|
| 500 | 3 |
| Total Numbers | 3 |

For DMA 21

| Proposed Pipe DI K9 | Diameter of pipe in mm | Length of pipe in M |
|---------------------|------------------------|---------------------|
| 100mm | 1773 | |
| 150mm | 601 | |
| 300mm | 33 | |
| Total Length | 2607 | |

| Bulk Flow metre | | | |
|-----------------|------------------------|-----|---------------------------|
| Description | Diameter of Pipe in mm | Nos | Type of flow metre |
| BFM 3 | 100 | 1 | Electromagnetic full bore |

| Pressure Reducing Valve (PRV) | | | |
|-------------------------------|-----------------------|---|------------------------|
| Description | Diameter of PRV in mm | Diameter of Initial Pressure Setting in M | Diameter of Pipe in mm |
| PRV 9 | 400 | 600 | 11 14 12 17 |
| PRV 11 | 200 | 300 | 7 7 16 15 |

| Proposed Sluice Valve DI | |
|--------------------------------|-----------|
| Diameter of Sluice Valve in mm | Numbers |
| 100 | 6 |
| 150 | 3 |
| 200 | 1 |
| 250 | 1 |
| 300 | 11 |
| Total Numbers | 22 |

| No of Pressure Loggers | |
|------------------------|----------|
| 100 | 5 |
| Total Numbers | 5 |

| No of Water Quantity Loggers | |
|------------------------------|----------|
| 100 | 1 |
| Total Numbers | 1 |

For DMA 10

| Proposed Pipe DI K9 | Diameter of pipe in mm | Length of pipe in M |
|---------------------|------------------------|---------------------|
| 100mm | 2025 | |
| 150mm | 1684 | |
| 200mm | 133 | |
| 300mm | 432 | |
| 500mm | 691 | |
| Total Length | 4335 | |

| Bulk Flow metre | | | |
|-----------------|------------------------|-----|---------------------------|
| Description | Diameter of Pipe in mm | Nos | Type of flow metre |
| BFM 4 | 150 | 1 | Electromagnetic full bore |

| Pressure Reducing Valve (PRV) | | | |
|-------------------------------|-----------------------|---|------------------------|
| Description | Diameter of PRV in mm | Diameter of Initial Pressure Setting in M | Diameter of Pipe in mm |
| PRV 4 | 300 | 300 | 12 7 16 10 |
| PRV 5 | 100 | 150 | 12 5 15 9 |
| PRV 6 | 100 | 150 | 12 6 15 8 |
| PRV 7 | 400 | 500 | 10 8 11 11 |

| Proposed Sluice Valve DI | |
|--------------------------------|-----------|
| Diameter of Sluice Valve in mm | Numbers |
| 100 | 2 |
| 150 | 8 |
| 250 | 1 |
| 300 | 10 |
| Total Numbers | 10 |

| No of Pressure Loggers | |
|------------------------|----------|
| 150 | 6 |
| Total Numbers | 6 |

| No of Water Quantity Loggers | |
|------------------------------|----------|
| 150 | 1 |
| Total Numbers | 1 |

| | | | | | |
|---|----------|------------|----|-----|----|
| 4 | | | | | |
| 3 | | | | | |
| 2 | | | | | |
| 1 | 20.07.18 | FOR TENDER | BR | GNG | MS |
| 0 | 30.06.18 | FOR TENDER | BR | GNG | MS |

Rev. Date Description
 File name: WTE-2297-HI_ZONE_10.11.12.21_24_IMMEDIATE_STAGE_2018.dwg

Client: **Wadia Techno Engg. Services Pvt. Ltd., Mumbai**
 Client: **SOLAPUR CITY DEVELOPMENT CORPORATION LTD.**
 Project: DESIGN, DEVELOP, MANAGE & IMPLEMENT URBAN INFRASTRUCTURE SERVICES PROJECTS UNDER SMART CITY MISSION (SCM) IN SOLAPUR CITY

10th IMPROVEMENT OF WATER DISTRIBUTION SYSTEM FOR DMA 10,11,12,24,21 (HIGH LEVEL GSR) (IMMEDIATE STAGE - 2018) FOR ABD AREA

North of Scale: **A 0 NTS**
 Job no: **WTE-2297** 00 W 2.05 R1 1 1
 Scale Job no. Code Discipline Drg. no. Rev. Sheet of

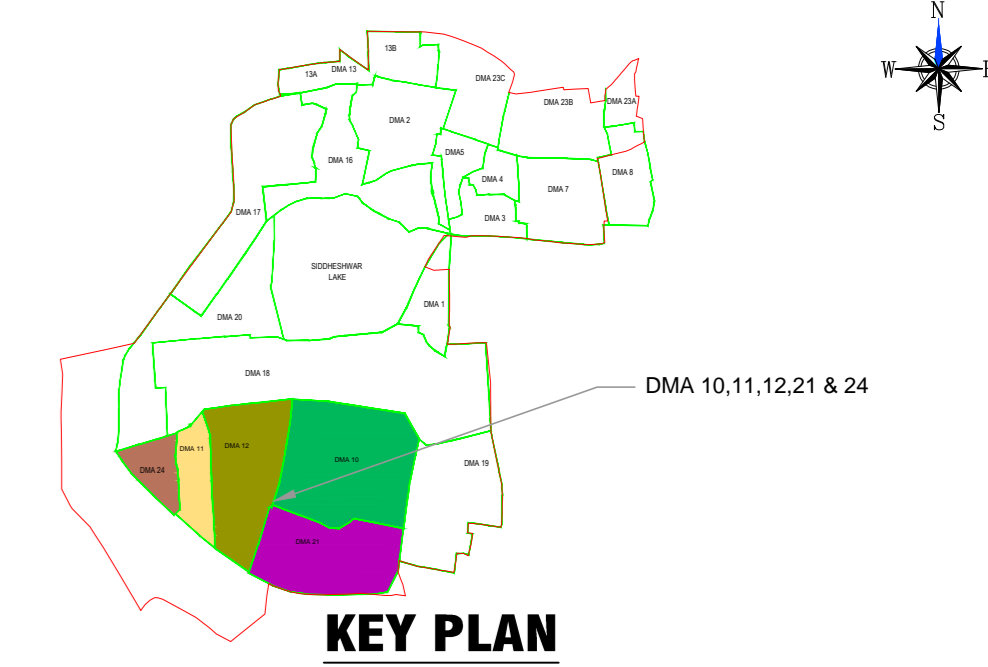
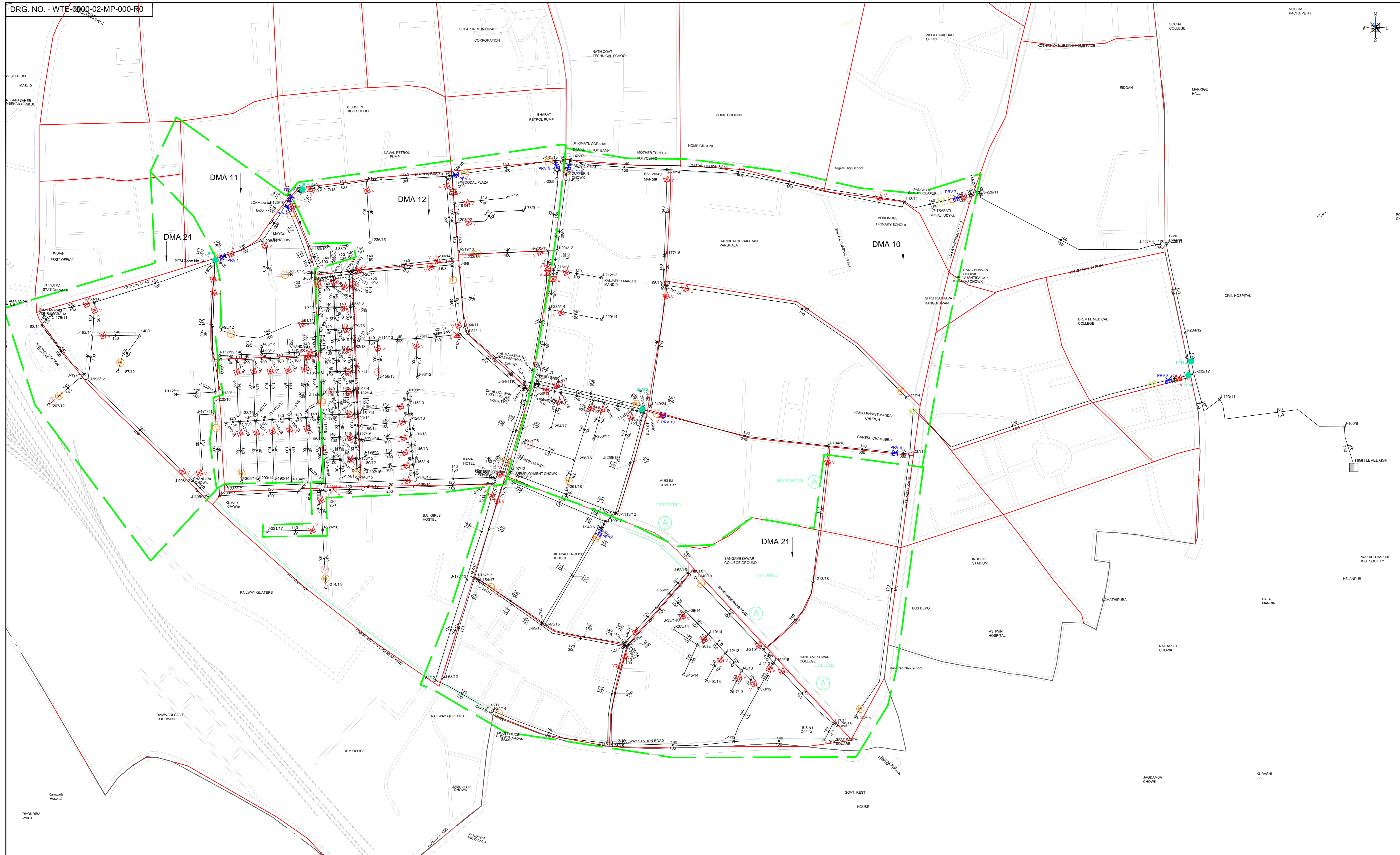

NOTES :-
 (A) DUE TO NO DEVELOPMENT IN FUTURE WATER PIPE LINE IS NOT PROPOSED ON OTHER SIDE OF SMART ROADS

REFERENCE DRG. NO.

LEGEND :-

- V = PROPOSED SLUICE VALVE
- PRV = PROPOSED PRESSURE REDUCING VALVE
- AV = PROPOSED AIR VALVE
- PL = PROPOSED PRESSURE LOGGERS
- DMA = DISTRICT METERING AREA
- ESR = ELEVATED SERVICE RESERVOIR
- BFM = PROPOSED BULK FLOW METRE
- Q = PROPOSED WATER QUALITY LOGGERS

JUNCTION NO. / PRESSURE IN METRE HAZEN WILLIAMS CONSTANT (C) JUNCTION NO. / PRESSURE IN METRE

| | |
|-----|----------------------|
| 100 | EXISTING CI PIPES |
| 120 | EXISTING DI KT PIPES |
| 140 | PROPOSED DI K9 PIPES |

— SMART ROAD
 - - - ABD AREA BOUNDARY
 - - - DMA BOUNDARY

WTE DRAWING FOR COMMENTS / APPROVAL

SIGNATURE _____ DATE _____

| | | | | | |
|------|----------|-------------|-------|------|--------|
| 4 | | | | | |
| 3 | | | | | |
| 2 | | | | | |
| 1 | 20.07.18 | FOR TENDER | | BR | GNG MS |
| 0 | 30.06.18 | FOR TENDER | | BR | GNG MS |
| Rev. | Date | Description | Drawn | Chk. | App. |

File name : WTE-2297-HI-ZONE 10,11,12,21 & 24 ULTIMATE STAGE (2051).dwg

WTE Wadia Techno Eng. Services Ltd. Mumbai

Louis Berger

Client: **SOLAPUR CITY DEVELOPMENT CORPORATION LTD.**

Project: **TO DESIGN, DEVELOP, MANAGE & IMPLEMENT URBAN INFRASTRUCTURE SERVICES PROJECTS UNDER SMART CITY MISSION (SCM) IN SOLAPUR CITY.**

1th IMPROVEMENT OF WATER DISTRIBUTION SYSTEM FOR DMA 10,11,12,21,24 (HIGH LEVEL GSR) (ULTIMATE STAGE - 2051) FOR ABD AREA

North: **WTE-2297** 00 W 2.15 R1 1 1

Scale: _____ Job no. _____ Code _____ Discipline _____ Drg. no. _____ Rev. _____ Sheet _____ of _____

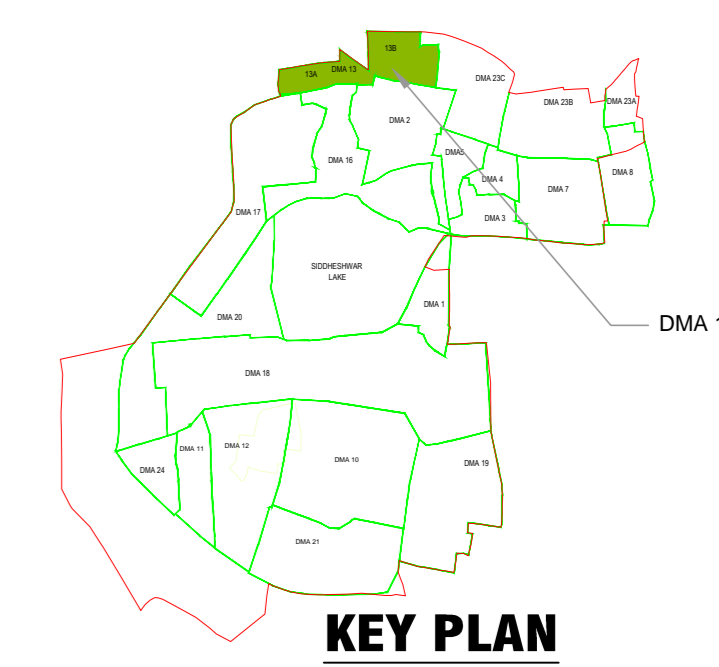
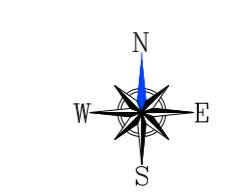

For DMA 13/B

| Proposed Pipe DI K9 | | Bulk Flow Meter | | | |
|------------------------|---------------------|-----------------|------------------------|-----|---------------------------|
| Diameter of pipe in mm | Length of pipe in M | Description | Diameter of Pipe in mm | Nos | Type of flow meter |
| 100mm | 2485 | BFM 2 | 100 | 1 | Electromagnetic full bore |
| 150mm | 73 | BFM 3 | 100 | 1 | Electromagnetic full bore |
| 200mm | 171 | | | | |
| 250mm | 127 | | | | |
| 300mm | 547 | | | | |
| Total Length | | 3403 | | | |

| Proposed Sluice Valve DI | | |
|--------------------------------|---------|----|
| Diameter of Sluice Valve in mm | Numbers | |
| 100 | 28 | |
| 150 | 1 | |
| 200 | 3 | |
| 250 | 2 | |
| 300 | 1 | |
| Total Numbers | | 35 |

| Pressure Reducing Valve (PRV) | | | | | |
|-------------------------------|------------------------|------------------------|-------------------------------|------|------|
| Description | Diameter of Pipe in mm | Diameter of Pipe in mm | Initial Pressure Setting in M | 2018 | 2021 |
| PRV 2 | 200 | 300 | 7 | 5 | 12 |

| | |
|-----------------------------|---|
| No of Pressure Loggers | 4 |
| No of Water Quality Loggers | 4 |

Pressure Logger (Transmitter)

| Sr. No. | Tag No. | Near by Junction | Line Pressure in M |
|---------|---------------|------------------|--------------------|
| 1 | DMA-13A-PL-01 | J-16 | 5 |
| 2 | DMA-13A-PL-02 | J-61 | 6 |
| 3 | DMA-13A-PL-03 | J-80 | 7 |
| 4 | DMA-13A-PL-04 | J-112 | 7 |
| 5 | DMA-13A-PL-05 | J-92 | 7 |
| 6 | DMA-13A-PL-06 | J-141 | 8 |
| 7 | DMA-13B-PL-01 | J-101 | 7 |
| 8 | DMA-13B-PL-02 | J-126 | 8 |
| 9 | DMA-13B-PL-03 | J-132 | 8 |
| 10 | DMA-13B-PL-04 | J-60 | 6 |

Water Quality Logger

| Sr. No. | Tag No. | Near by Junction |
|---------|---------------|------------------|
| 1 | DMA-13A-QA-01 | J-16 |
| 2 | DMA-13A-QA-02 | J-61 |
| 3 | DMA-13A-QA-03 | J-80 |
| 4 | DMA-13A-QA-04 | J-112 |
| 5 | DMA-13A-QA-05 | J-92 |
| 6 | DMA-13A-QA-06 | J-141 |
| 7 | DMA-13B-QA-01 | J-101 |
| 8 | DMA-13B-QA-02 | J-126 |
| 9 | DMA-13B-QA-03 | J-132 |
| 10 | DMA-13B-QA-04 | J-60 |

Flow Meter

| Sr. No. | Tag No. | Near by Junction |
|---------|---------------|------------------|
| 1 | DMA-13B-FT-01 | J-141 |
| 2 | DMA-13B-FT-01 | J-100 |
| 3 | DMA-13B-FT-02 | J-80 |

For DMA 13/A

| Proposed Pipe DI K9 | | |
|------------------------|---------------------|------|
| Diameter of pipe in mm | Length of pipe in M | |
| 100mm | 2084 | |
| 150mm | 188 | |
| 200mm | 74 | |
| 250mm | 520 | |
| 300mm | 277 | |
| Total Length | | 3143 |

| Proposed Sluice Valve | | |
|--------------------------------|---------|----|
| Diameter of Sluice Valve in mm | Numbers | |
| 100 | 25 | |
| 150 | 3 | |
| 250 | 8 | |
| 300 | 6 | |
| 350 | 1 | |
| Total Numbers | | 40 |

| Bulk Flow Meter | | | |
|-----------------|------------------------|--------------------|---------------------------|
| Description | Diameter of Pipe in mm | Type of flow meter | |
| BFM 1 | 100 | 1 | Electromagnetic full bore |

| Schedule of Pressure Reducing Valve (PRV) | | | | | |
|---|------------------------|------------------------|-------------------------------|------|------|
| Description | Diameter of Pipe in mm | Diameter of Pipe in mm | Initial Pressure Setting in M | 2018 | 2021 |
| PRV 1 | 400 | 500 | 8 | 8 | 13 |

| | |
|-----------------------------|---|
| No of Pressure Loggers | 6 |
| No of Water Quality Loggers | 6 |

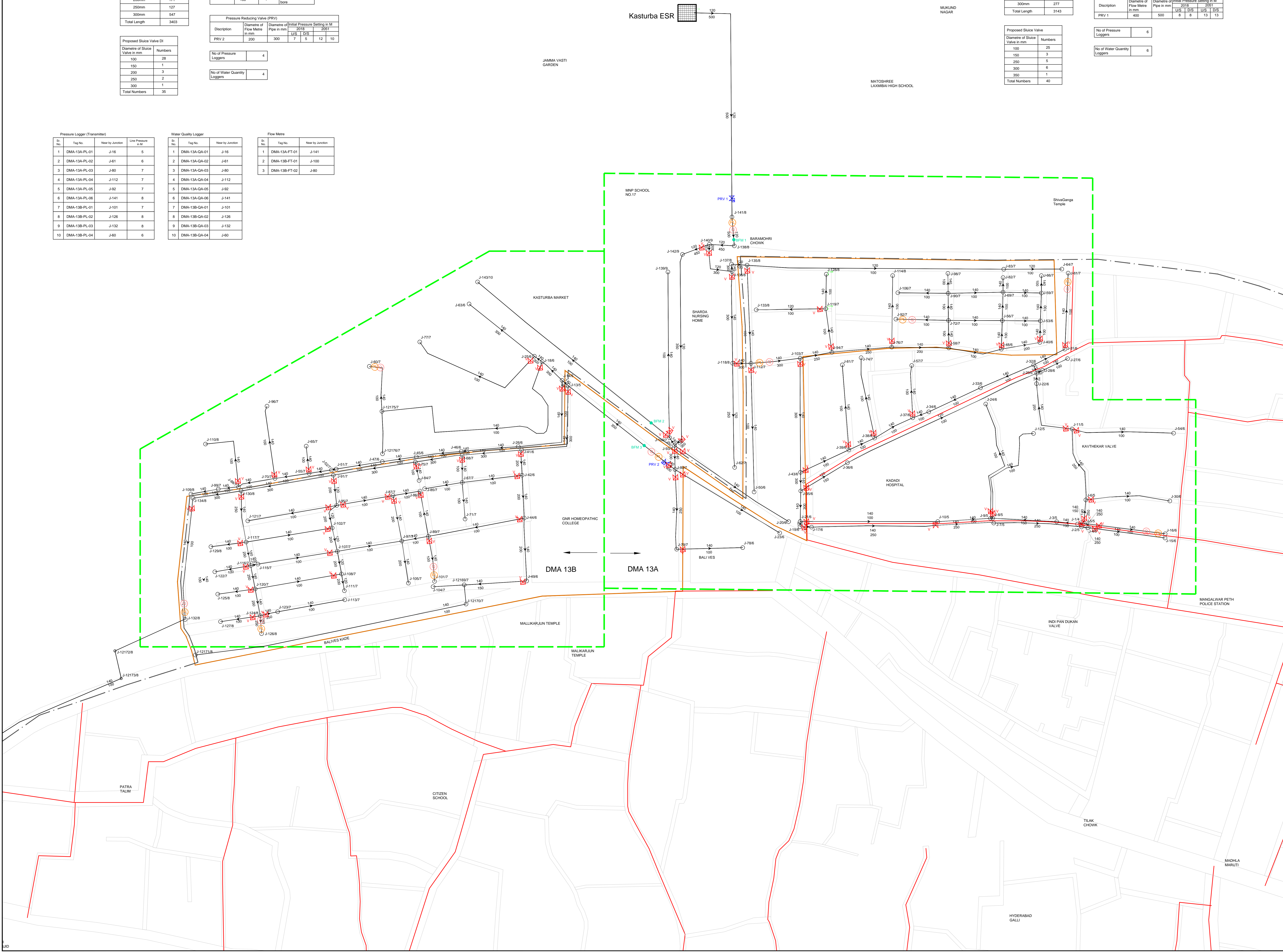

NOTES :-

⊕ DUE TO NO DEVELOPMENT IN FUTURE WATER PIPE LINE IS NOT PROPOSED ON OTHER SIDE OF SMART ROADS

REFERENCE DRG. NO.

LEGEND :-

- ⊕ V = PROPOSED SLUICE VALVE
 - ⊕ PRV = PROPOSED PRESSURE REDUCING VALVE
 - ⊕ AV = PROPOSED AIR VALVE
 - ⊕ PL = PROPOSED PRESSURE LOGGERS
 - ⊕ DMA = DISTRICT METREING AREA
 - ⊕ ESR = ELEVATED SERVICE RESERVOIR
 - ⊕ BFM = PROPOSED BULK FLOW METRE
 - ⊕ Q = PROPOSED WATER QUALITY LOGGERS
- JUNCTION NO. / PRESSURE IN METRE HAZEN WILLIAM'S CONSTANT(C) JUNCTION NO. / PRESSURE IN METRE
- | DIAMETER OF PIPE IN mm | |
|------------------------|----------------------|
| 'C' VALUE | |
| 100 | EXISTING CI PIPES |
| 120 | EXISTING DI K7 PIPES |
| 140 | PROPOSED DI K9 PIPES |
- SMART ROAD
 - ABD AREA BOUNDARY
 - - - DMA BOUNDARY

WTE DRAWING FOR COMMENTS / APPROVAL

SIGNATURE _____ DATE _____

| | | | | | |
|-----|----------|-------------|-------|------|------|
| 4 | | | | | |
| 3 | | | | | |
| 2 | | | | | |
| 1 | 20.07.18 | FOR TENDER | BR | GNG | MS |
| 0 | 30.06.18 | FOR TENDER | BR | GNG | MS |
| Rev | Date | Description | Drawn | Clk. | App. |

File name: WTE-2297-HZ-ZONE 13 IMMEDIATE STAGE (2018).dwg

WTE Wadia Techno Eng. Services Ltd. Mumbai **LB** Louis Berger

Client: SOLAPUR CITY DEVELOPMENT CORPORATION LTD.

Project: DESIGN, DEVELOP, MANAGE & IMPLEMENT URBAN INFRASTRUCTURE SERVICES PROJECTS UNDER SMART CITY MISSION (SCM) IN SOLAPUR CITY.

Title: IMPROVEMENT OF WATER DISTRIBUTION SYSTEM FOR DMA 13 (KASTURBA) (IMMEDIATE STAGE - 2018)

North of 10 Scale: 1:1000 Job no: WTE-2297 Code: 00 W 2.06 R1 1 1

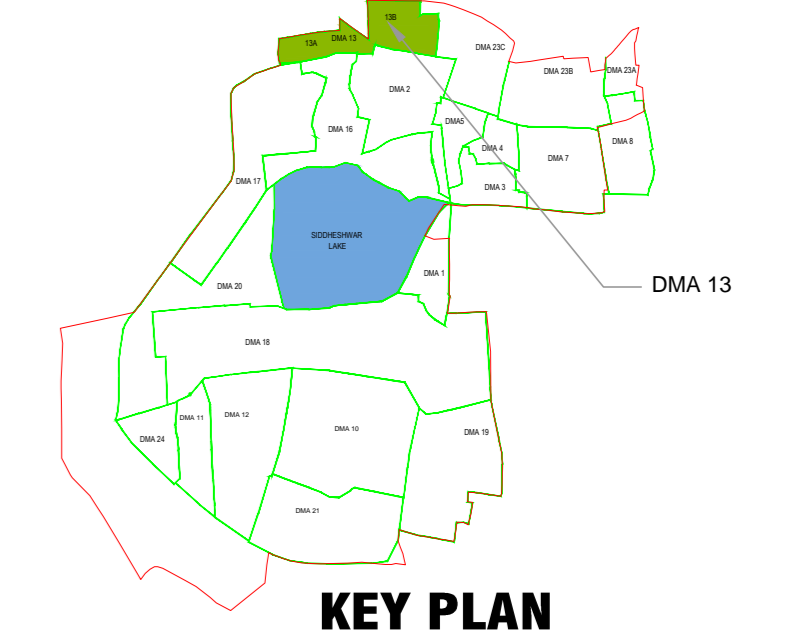
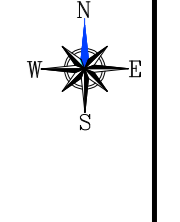
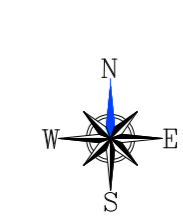

KEY PLAN

NOTES :-

(A) DUE TO NO DEVELOPMENT IN FUTURE WATER PIPE LINE IS NOT PROPOSED ON OTHER SIDE OF SMART ROADS

REFERENCE DRG. NO.

LEGEND :-

- V = PROPOSED SLUICE VALVE
 - PRV = PROPOSED PRESSURE REDUCING VALVE
 - AV = PROPOSED AIR VALVE
 - PL = PROPOSED PRESSURE LOGGERS
 - DMA = DISTRICT METREING AREA
 - ESR = ELEVATED SERVICE RESERVOIR
 - BFM = PROPOSED BULK FLOW METRE
 - Q = PROPOSED WATER QUALITY LOGGERS
- JUNCTION NO. / PRESSURE IN METRE HAZEN WILLIAMS CONSTANT(C) JUNCTION NO. / PRESSURE IN METRE
- DIAMETRE OF PIPE IN mm
- | C' VALUE |
|--------------------------|
| 100 EXISTING CI PIPES |
| 120 EXISTING CI KY PIPES |
| 140 PROPOSED DI K9 PIPES |
- SMART ROAD
 - ABD AREA BOUNDARY
 - DMA BOUNDARY

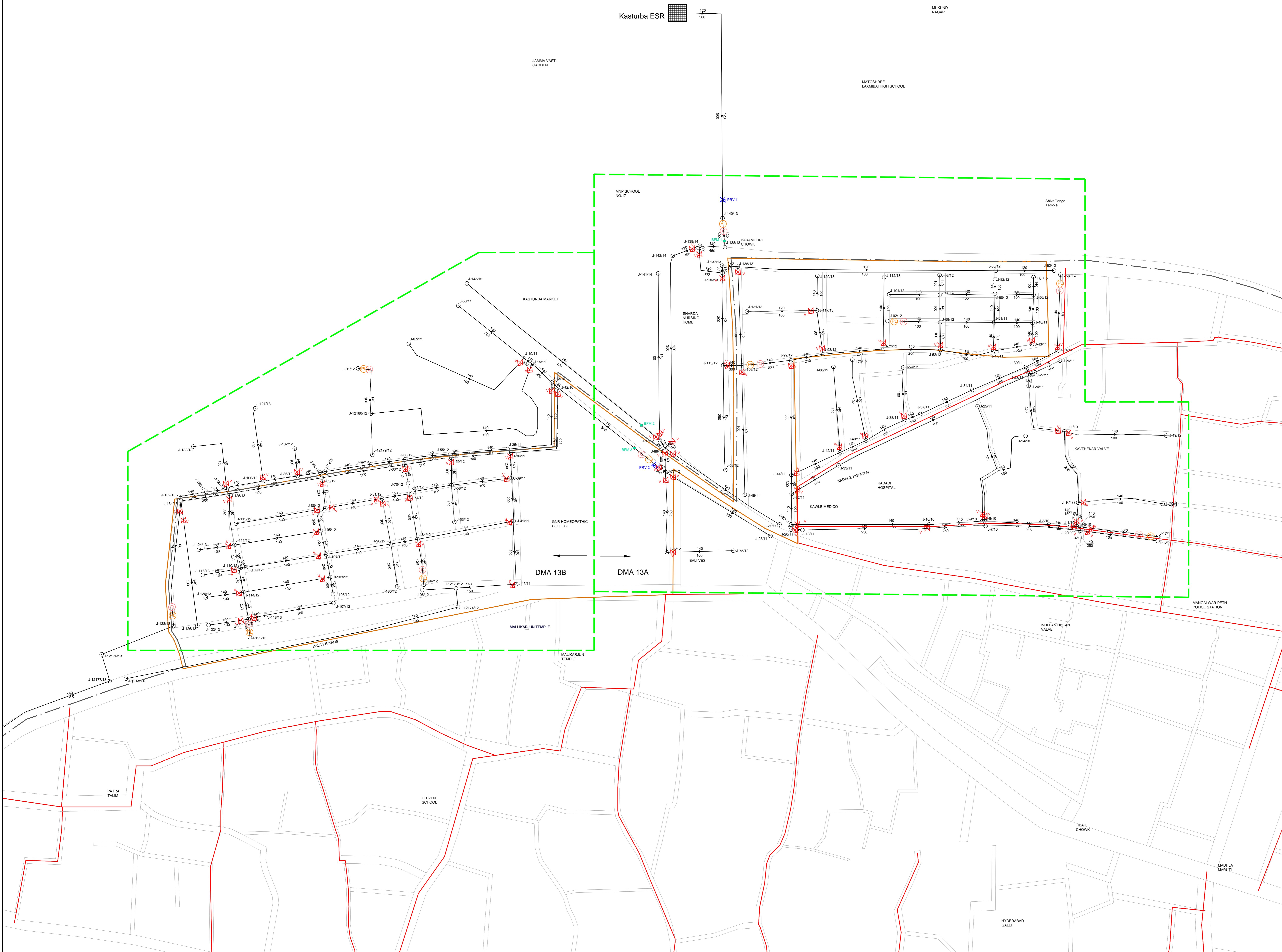

WTE DRAWING FOR COMMENTS / APPROVAL

SIGNATURE _____ DATE _____

| | | | | | |
|-----|----------|-------------|-------|------|------|
| 4 | | | | | |
| 3 | | | | | |
| 2 | | | | | |
| 1 | 20.07.18 | FOR TENDER | BR | GNG | MS |
| 0 | 30.06.18 | FOR TENDER | BR | GNG | MS |
| Rev | Date | Description | Drawn | Chk. | App. |

File name: WTE-2297-HZ-ZONE 13 ULTIMATE STAGE (2051).dwg

| | | | |
|--|---|----------|---------------------|
| | Wadia Techno Engg. Services Ltd. Mumbai | | Louis Berger |
| Client: SOLAPUR CITY DEVELOPMENT CORPORATION LTD. | | | |
| Project: DESIGN, DEVELOP, MANAGE & IMPLEMENT URBAN INFRASTRUCTURE SERVICES PROJECTS UNDER SMART CITY MISSION (SCM) IN SOLAPUR CITY | | | |
| Title: IMPROVEMENT OF WATER DISTRIBUTION SYSTEM FOR DMA 13 (KASTURBA) (ULTIMATE STAGE - 2051) FOR ABD AREA | | | |
| North of Scale | A 0 NTS | WTE-2297 | 00 W 2.16 R1 1 1 |

For DMA 16

| Proposed Pipe DI K9 | Diameter of pipe in mm | Length of pipe in M |
|---------------------|------------------------|---------------------|
| 100mm | 3463 | |
| 150mm | 3038 | |
| 200mm | 783 | |
| 250mm | 238 | |
| 300mm | 1103 | |
| 400mm | 12 | |
| 500 | 1 | |
| Total Length | 8697 | |

| Bulk Flow Meter | Description | Diameter of Flow Meter in mm | No. | Type of flow metre |
|-----------------|-------------|------------------------------|---------------------------|--------------------|
| BFM 3 | 100 | 1 | Electromagnetic full bore | |

| Pressure Reducing Valve (PRV) | Description | Diameter of PRV in mm | Initial Pressure Setting in M | Final Pressure Setting in M |
|-------------------------------|-------------|-----------------------|-------------------------------|-----------------------------|
| PRV 1 | 400 | 525 | 7 | 3 |
| PRV 2 | 300 | 525 | 7 | 3 |

| Proposed Sluice Valve DI | Diameter of Sluice Valve in mm | Numbers |
|--------------------------|--------------------------------|---------|
| 100 | 38 | |
| 150 | 16 | |
| 250 | 4 | |
| 300 | 1 | |
| 350 | 5 | |
| 400 | 2 | |
| 500 | 1 | |
| Total Numbers | 67 | |

| No of Pressure Loggers | 7 |
|------------------------|---|
| No of Quality Loggers | 5 |

| Pressure Logger (Transmitter) | Tag No. | Near to Junction | Line Pressure in M |
|-------------------------------|--------------|------------------|--------------------|
| 1 | DMA-16-PL-01 | J-12 | 3 |
| 2 | DMA-16-PL-02 | J-30 | 3 |
| 3 | DMA-16-PL-03 | J-32 | 3 |
| 4 | DMA-16-PL-04 | J-160 | 6 |
| 5 | DMA-16-PL-05 | J-273 | 9 |
| 6 | DMA-16-PL-06 | J-252 | 8 |
| 7 | DMA-16-PL-07 | J-225 | 8 |

| Water Quality Logger | Tag No. | Near to Junction |
|----------------------|--------------|------------------|
| 1 | DMA-16-QA-01 | J-160 |
| 2 | DMA-16-QA-02 | J-208 |
| 3 | DMA-16-QA-03 | J-207 |
| 4 | DMA-16-QA-04 | BUS STAND KADE |
| 5 | DMA-16-QA-05 | J-227 |

| Flow Meter | Tag No. | Near to Junction |
|------------|-------------|------------------|
| 1 | DMA-16FT-01 | J-237 |

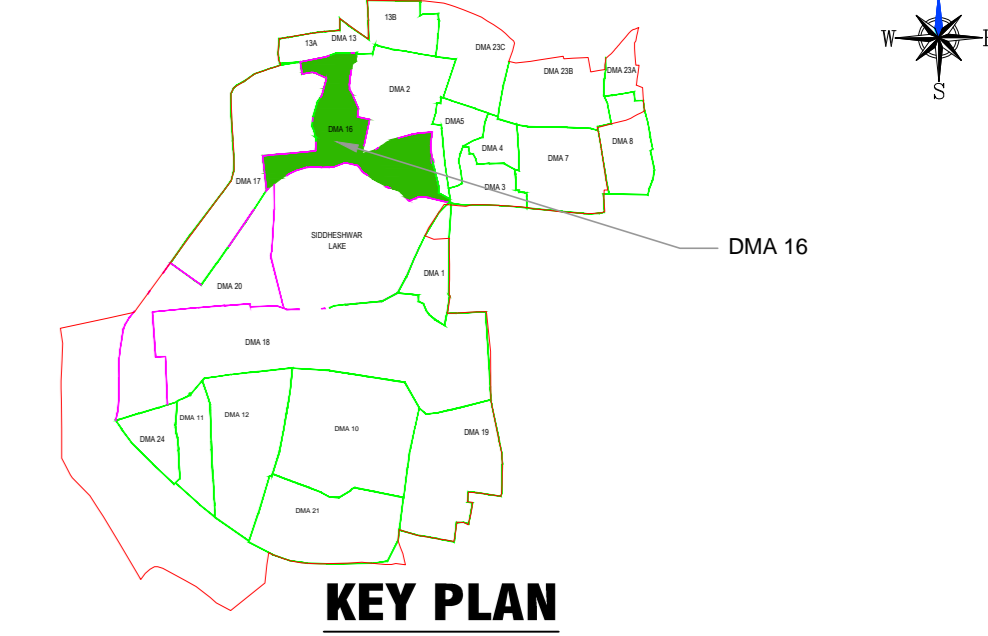
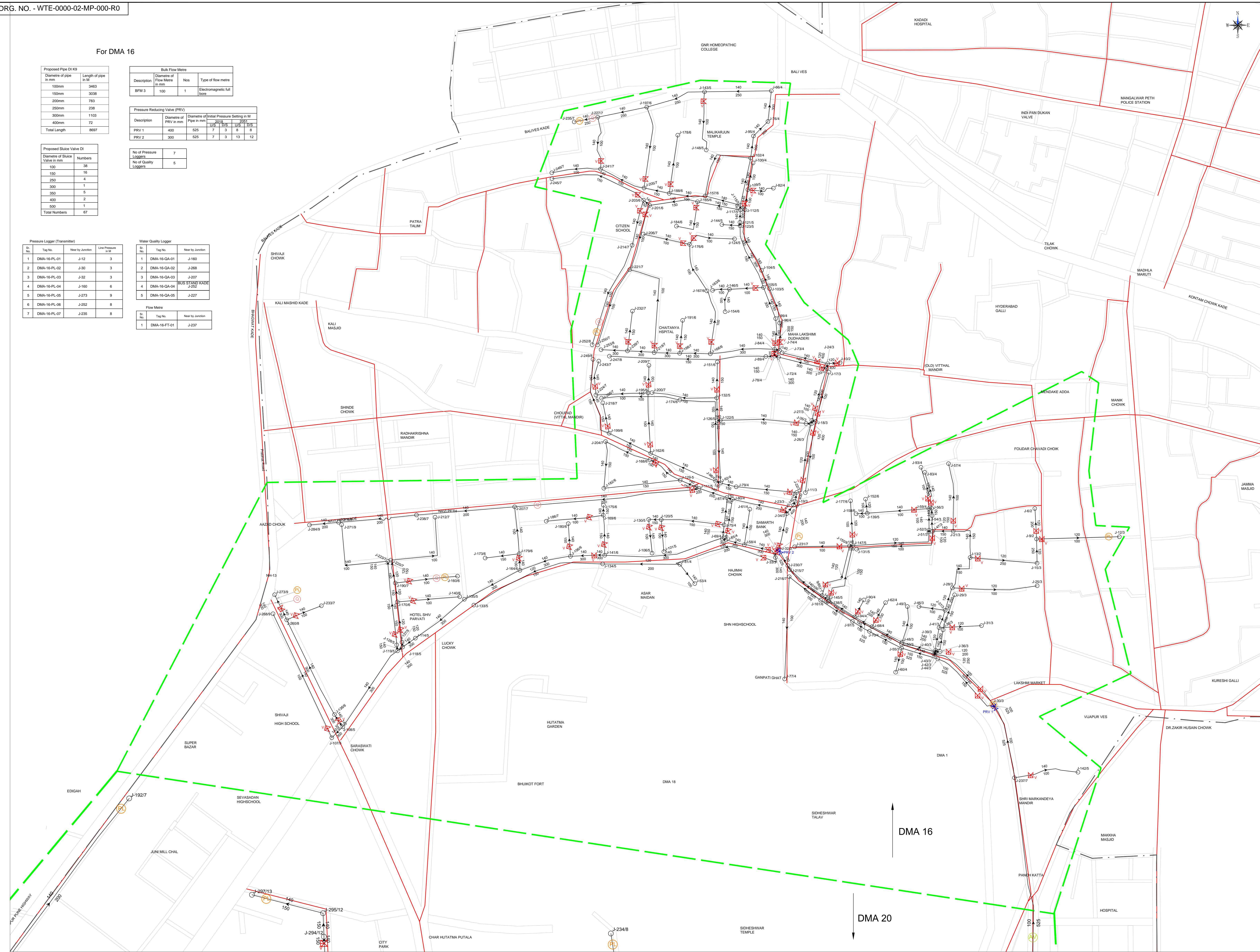

NOTES :-
 (1) DUE TO NO DEVELOPMENT IN FUTURE WATER PIPE LINE IS NOT PROPOSED ON OTHER SIDE OF SMART ROADS

REFERENCE DRG. NO.

- LEGEND :-**
- V = PROPOSED SLUICE VALVE
 - PRV = PROPOSED PRESSURE REDUCING VALVE
 - AV = PROPOSED AIR VALVE
 - PL = PROPOSED PRESSURE LOGGERS
 - DMA = DISTRICT METREING AREA
 - ESR = ELEVATED SERVICE RESERVOIR
 - BFM = PROPOSED BULK FLOW METRE
 - Q = PROPOSED WATER QUALITY LOGGERS
- JUNCTION NO. / PRESSURE IN METRE HAZEN WILLIAMS CONSTANT(C) JUNCTION NO. / PRESSURE IN METRE
- DIAMETRE OF PIPE IN mm
- | | |
|-----|----------------------|
| 100 | EXISTING CI PIPES |
| 120 | EXISTING DI KY PIPES |
| 140 | PROPOSED DI K9 PIPES |
- SMART ROAD
 - ABD AREA BOUNDARY
 - DMA BOUNDARY

WTE DRAWING FOR COMMENTS / APPROVAL

SIGNATURE _____ DATE _____

| | | | | | |
|------|----------|-------------|-------|------|------|
| 4 | | | | | |
| 3 | | | | | |
| 2 | | | | | |
| 1 | 20.07.18 | FOR TENDER | BR | GNG | MS |
| 0 | 30.06.18 | FOR TENDER | BR | GNG | MS |
| Rev. | Date | Description | Drawn | Clk. | App. |

File name: WTE-2297-HZ-ZONE 16 & 20 IMMEDIATE STAGE (2018).dwg

WTE Wadia Techno Engg. Services Ltd. **Louis Berger**

Client: SOLAPUR CITY DEVELOPMENT CORPORATION LTD.

Project: DESIGN, DEVELOP, MANAGE & IMPLEMENT URBAN INFRASTRUCTURE SERVICES PROJECTS UNDER SMART CITY MISSION (SCM) IN SOLAPUR CITY.

Title: IMPROVEMENT OF WATER DISTRIBUTION SYSTEM FOR DMA 16 & 20 (PARCIAVAL GSR A & B) (IMMEDIATE STAGE - 2018) FOR ABD AREA

North of Scale: A 0 NTS **WTE-2297** 00 W 2.07 R1 1 2

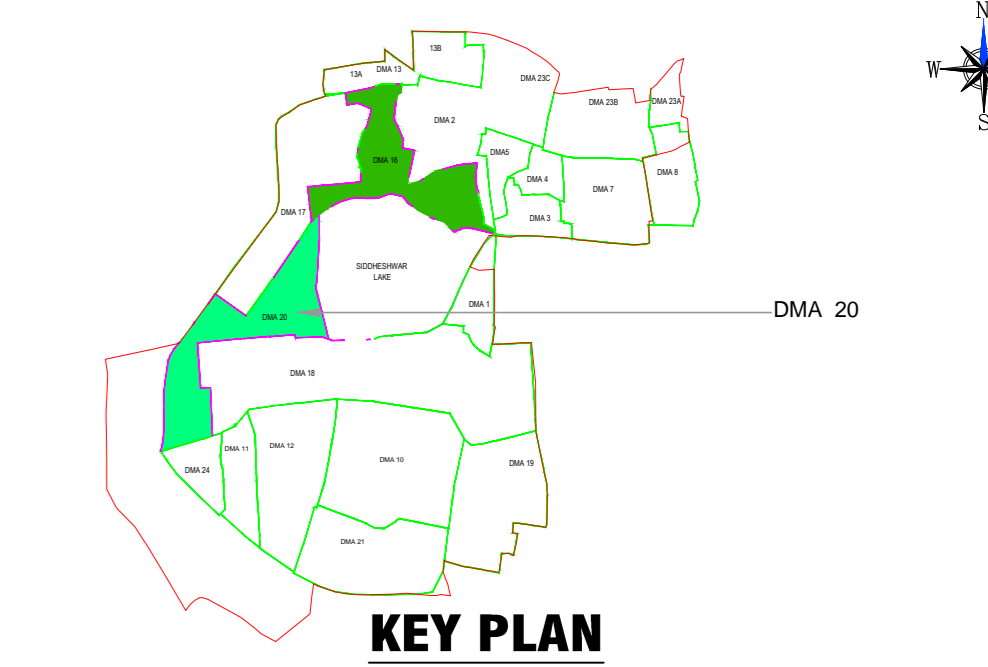
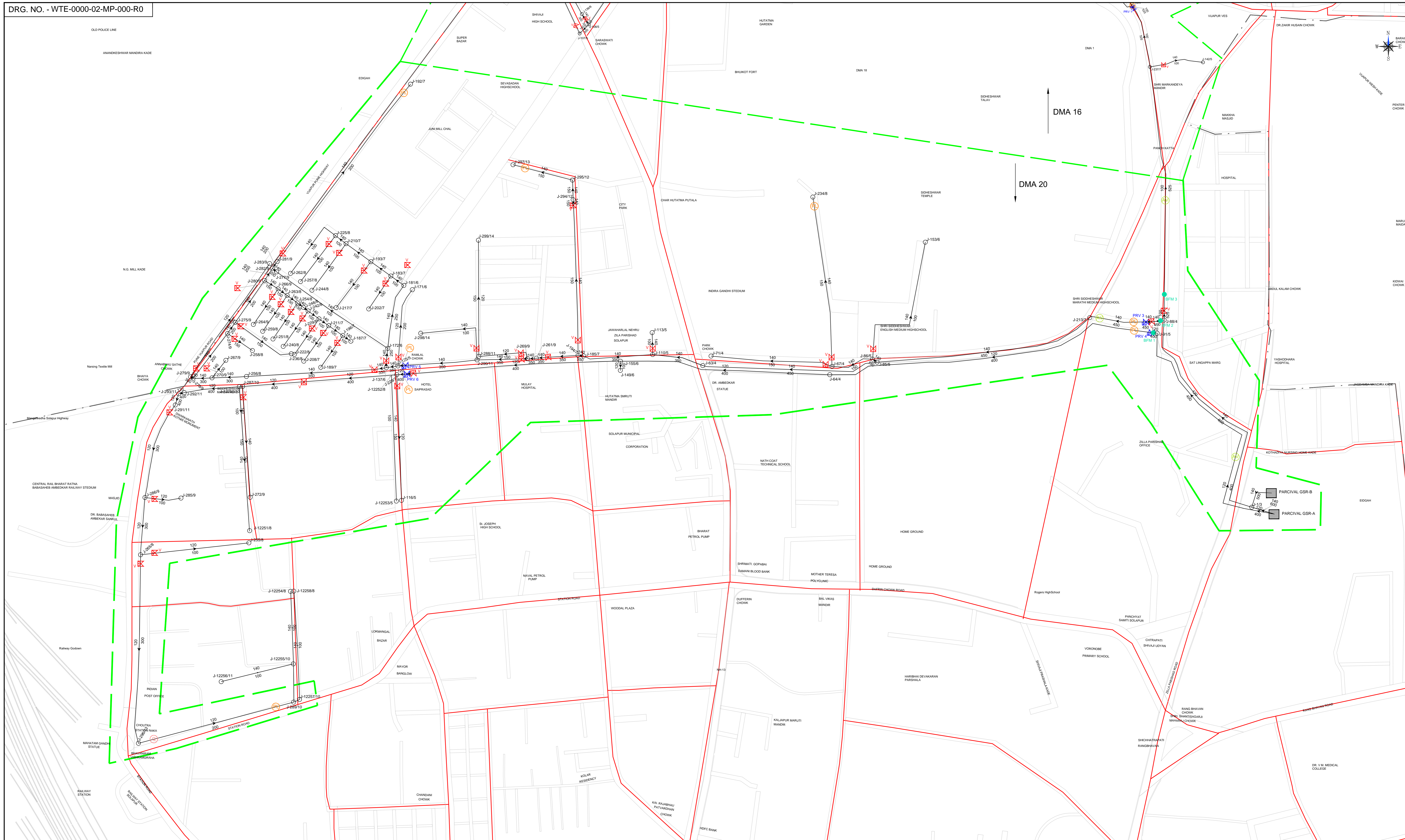

NOTES :-
 (A) DUE TO NO DEVELOPMENT IN FUTURE WATER PIPE LINE IS NOT PROPOSED ON OTHER SIDE OF SMART ROADS

REFERENCE DRG. NO.

- LEGEND :-**
- V = PROPOSED SLUICE VALVE
 - PRV = PROPOSED PRESSURE REDUCING VALVE
 - AV = PROPOSED AIR VALVE
 - PL = PROPOSED PRESSURE LOGGERS
 - DMA = DISTRICT METREING AREA
 - ESR = ELEVATED SERVICE RESERVOIR
 - BFM = PROPOSED BULK FLOW METRE
 - Q = PROPOSED WATER QUALITY LOGGERS
- JUNCTION NO. / PRESSURE IN METRE HAZEN WILLIAMS CONSTANT(C) JUNCTION NO. / PRESSURE IN METRE
- DIAMETRE OF PIPE IN mm
- | | |
|-----|----------------------|
| 100 | EXISTING CI PIPES |
| 120 | EXISTING DI K7 PIPES |
| 140 | PROPOSED DI K9 PIPES |
- SMART ROAD
 - ABD AREA BOUNDARY
 - DMA BOUNDARY

For DMA 20

| Proposed New DI K9 | Length of pipe in M |
|------------------------|---------------------|
| DIAMETRE of pipe in mm | |
| 100mm | 2438 |
| 150mm | 953 |
| 200mm | 525 |
| 250mm | 121 |
| 300mm | 80 |
| 350mm | 651 |
| 400mm | 673 |
| 500mm | 44 |
| 600mm | 412 |
| Total Length | 5897 |

| Bulk Flow Meter | | | |
|-----------------|------------|-----|---------------------------|
| Description | Flow Meter | No. | Type of flow metre |
| BFM 1 | 100 | 1 | Electromagnetic full bore |
| BFM 2 | 100 | 1 | Electromagnetic full bore |

| Pressure Reducing Valve (PRV) | | | |
|-------------------------------|------------------------|-------------------------------|-----------------------------|
| Description | Diameter of Pipe in mm | Initial Pressure Setting in M | Final Pressure Setting in M |
| PRV 3 | 400 | 4.7 | 5.8 |
| PRV 4 | 300 | 4.4 | 5.4 |
| PRV 5 | 300 | 11.5 | 11.10 |
| PRV 6 | 300 | 4.0 | 6.7 |

| Pressure Logger (Transmitter) | | | |
|-------------------------------|--------------|------------------|--------------------|
| Sl. No. | Tag No. | Near by Junction | Line Pressure in M |
| 1 | DMA-20-PL-01 | J-88 | 5 |
| 2 | DMA-20-PL-02 | J-91 | 5 |
| 3 | DMA-20-PL-03 | J-234 | 7 |
| 4 | DMA-20-PL-04 | J-237 | 13 |
| 5 | DMA-20-PL-05 | J-192 | 7 |
| 6 | DMA-20-PL-06 | J-228 | 7 |
| 7 | DMA-20-PL-07 | J-125 | 5 |
| 8 | DMA-20-PL-08 | J-289 | 10 |

| Water Quality Logger | | | |
|----------------------|--------------|------------------|--------------------|
| Sl. No. | Tag No. | Near by Junction | Line Pressure in M |
| 1 | DMA-20-QA-01 | J-160 | |

| Flow Meter | | | |
|------------|--------------|------------------|--------------------|
| Sl. No. | Tag No. | Near by Junction | Line Pressure in M |
| 1 | DMA-20-FT-01 | J-237 | |
| 2 | DMA-20-FT-02 | J-237 | |

WTE DRAWING FOR COMMENTS / APPROVAL

SIGNATURE _____ DATE _____

| | | | | | |
|---|----------|------------|----|-----|----|
| 4 | | | | | |
| 3 | | | | | |
| 2 | | | | | |
| 1 | 20.07.18 | FOR TENDER | BR | GNG | MS |
| 0 | 30.06.18 | FOR TENDER | BR | GNG | MS |

File name: WTE-2297-HZ-ZONE 16 & 20 IMMEDIATE STAGE (2018).dwg

WTE Wadia Techno Engg. Services Ltd. Mumbai **LB** Louis Berger

Client: SOLAPUR CITY DEVELOPMENT CORPORATION LTD.

Project: DESIGN, DEVELOP, MANAGE & IMPLEMENT URBAN INFRASTRUCTURE SERVICES PROJECTS UNDER SMART CITY MISSION (SCM) IN SOLAPUR CITY.

Title: IMPROVEMENT OF WATER DISTRIBUTION SYSTEM FOR DMA 16 & 20 (PARCIVAL GSR A & B) (IMMEDIATE STAGE - 2018) FOR ABD AREA

North of Scale: **A0** **WTE-2297** **00** **W** **2.07** **R1** **2** **2**

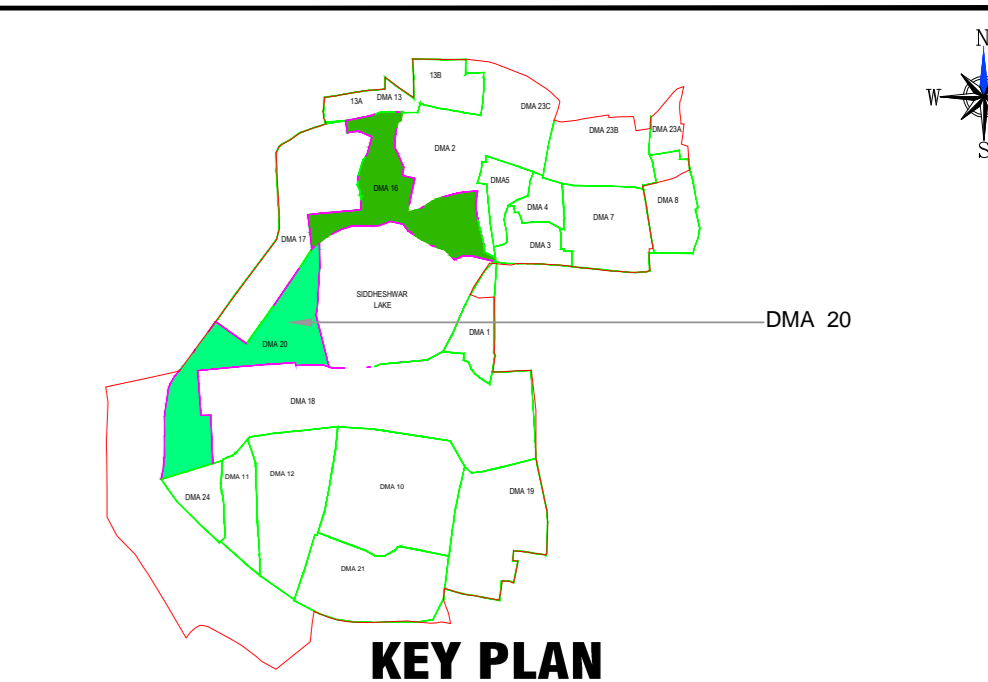
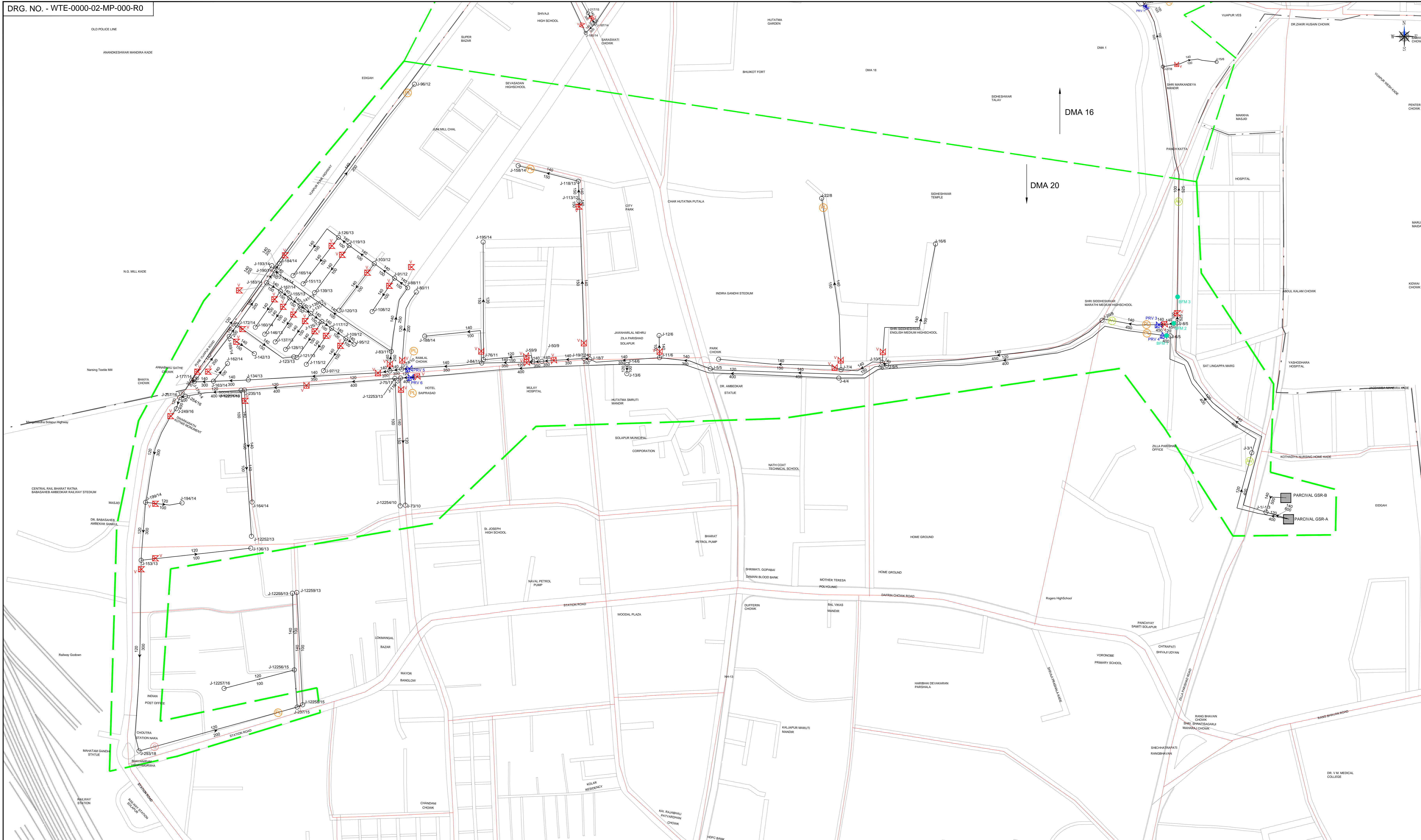

NOTES :-
 (A) DUE TO NO DEVELOPMENT IN FUTURE WATER PIPE LINE IS NOT PROPOSED ON OTHER SIDE OF SMART ROADS

REFERENCE DRG. NO.

- LEGEND :-**
- V = PROPOSED SLUIZE VALVE
 - PRV = PROPOSED PRESSURE REDUCING VALVE
 - AV = PROPOSED AIR VALVE
 - PL = PROPOSED PRESSURE LOGGERS
 - DMA = DISTRICT METREING AREA
 - ESR = ELEVATED SERVICE RESERVOIR
 - BFM = PROPOSED BULK FLOW METRE
 - Q = PROPOSED WATER QUALITY LOGGERS
- JUNCTION NO. / PRESSURE IN METRE
- HAZEN WILLIAM'S CONSTANT(C)
- JUNCTION NO. / PRESSURE IN METRE
- DIAMETRE OF PIPE IN mm
- | "C" VALUE | |
|-----------|----------------------|
| 100 | EXISTING CI PIPES |
| 120 | EXISTING DI K7 PIPES |
| 140 | PROPOSED DI K9 PIPES |
- SMART ROAD
 - ABD AREA BOUNDARY
 - DMA BOUNDARY

WTE DRAWING FOR COMMENTS / APPROVAL

SIGNATURE _____ DATE _____

| | | | | | |
|------|----------|-------------|-------|------|--------|
| 4 | | | | | |
| 3 | | | | | |
| 2 | | | | | |
| 1 | 20.07.18 | FOR TENDER | | BR | GNG MS |
| 0 | 30.06.18 | FOR TENDER | | BR | GNG MS |
| Rev. | Date | Description | Drawn | Chk. | App. |

File name : WTE-2297-W_ZONE 16 & 20 ULTIMATE STAGE (2051).dwg

WTE Wadia Techno Engg. Services Ltd. Mumbai

Louis Berger

Client: SOLAPUR CITY DEVELOPMENT CORPORATION LTD.

Project: DESIGN, DEVELOP, MANAGE & IMPLEMENT URBAN INFRASTRUCTURE SERVICES PROJECTS UNDER SMART CITY MISSION (SCM) IN SOLAPUR CITY

Title: IMPROVEMENT OF WATER DISTRIBUTION SYSTEM FOR DMA 16 & 20 (PARCIVAL GSR A & B) (ULTIMATE STAGE - 2051) FOR ABD AREA

North: A 0 NTS

Scale: WTE-2297 00 W 2.17 R1 2 2

Scale Job no. Code Discipline Drg no. Rev. Sheet of

For DMA 17

| Proposed Pipe DI K9 | Diameter of pipe in mm | Length of pipe in M |
|---------------------|------------------------|---------------------|
| 100mm | 5522 | |
| 150mm | 1250 | |
| 200mm | 140 | |
| 250mm | 236 | |
| 300mm | 361 | |
| Total Length | 7509 | |

| Bulk Flow Meter | | | |
|-----------------|------------------------------|-----|---------------------------|
| Description | Diameter of flow Meter in mm | No. | Type of flow metre |
| BFM 1 | 100 | 1 | Electromagnetic full bore |

| Pressure Reducing Valve (PRV) | | | | |
|-------------------------------|-----------------------|------------------------|-----------------------|-----------------------|
| Description | Diameter of PRV in mm | Diameter of Pipe in mm | Initial Pressure in M | Pressure Setting in M |
| PRV | 600 | 700 | 12 | 12 |
| | | | 12 | 18 |
| | | | 12 | 18 |

| No of Pressure Loggers | |
|------------------------|---|
| No of Pressure Loggers | 7 |

| No of Water Quantity Loggers | |
|------------------------------|---|
| No of Water Quantity Loggers | 7 |

| Proposed Sluice Valve DI | |
|--------------------------------|-----------|
| Diameter of Sluice Valve in mm | Numbers |
| 100 | 49 |
| 150 | 9 |
| 200 | 5 |
| 250 | 4 |
| 300 | 3 |
| 400 | 1 |
| 700 | 1 |
| Total Numbers | 72 |

| Pressure Logger (Characterist) | | | |
|--------------------------------|--------------|------------------|--------------------|
| Sl. No. | Tag No. | Near to Junction | Line Pressure in M |
| 1 | DMA-17-PL-01 | J-166 | 12 |
| 2 | DMA-17-PL-02 | J-170 | 12 |
| 3 | DMA-17-PL-03 | J-171 | 12 |
| 4 | DMA-17-PL-04 | J-62 | 8 |
| 5 | DMA-17-PL-05 | J-72 | 8 |
| 6 | DMA-17-PL-06 | J-55 | 7 |
| 7 | DMA-17-PL-07 | J-44 | 6 |

| Water Quality Logger | | | |
|----------------------|--------------|------------------|--------------------|
| Sl. No. | Tag No. | Near to Junction | Line Pressure in M |
| 1 | DMA-17-QA-01 | J-166 | |
| 2 | DMA-17-QA-02 | J-170 | |
| 3 | DMA-17-QA-03 | J-171 | |
| 4 | DMA-17-QA-04 | J-62 | |
| 5 | DMA-17-QA-05 | J-72 | |
| 6 | DMA-17-QA-06 | J-55 | |
| 7 | DMA-17-QA-07 | J-44 | |

| Flow Meter | | | |
|------------|--------------|------------------|--------------------|
| Sl. No. | Tag No. | Near to Junction | Line Pressure in M |
| 1 | DMA-17-FM-01 | J-166 | |

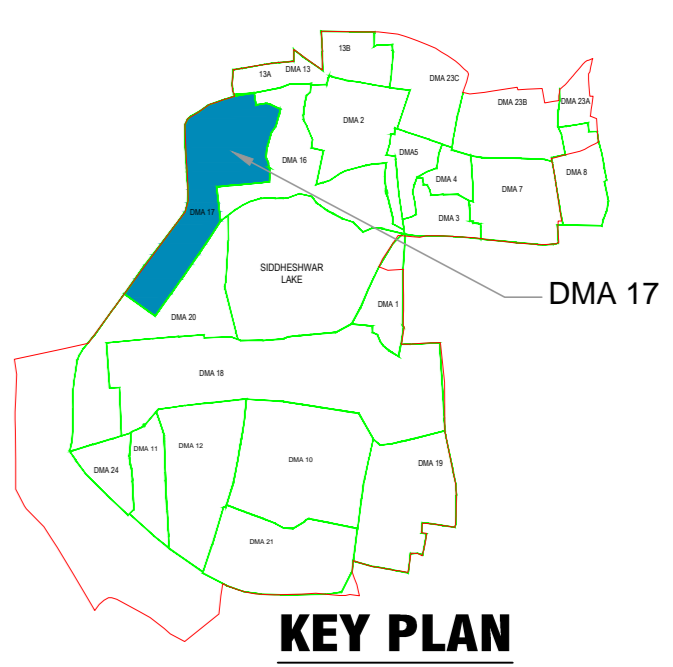
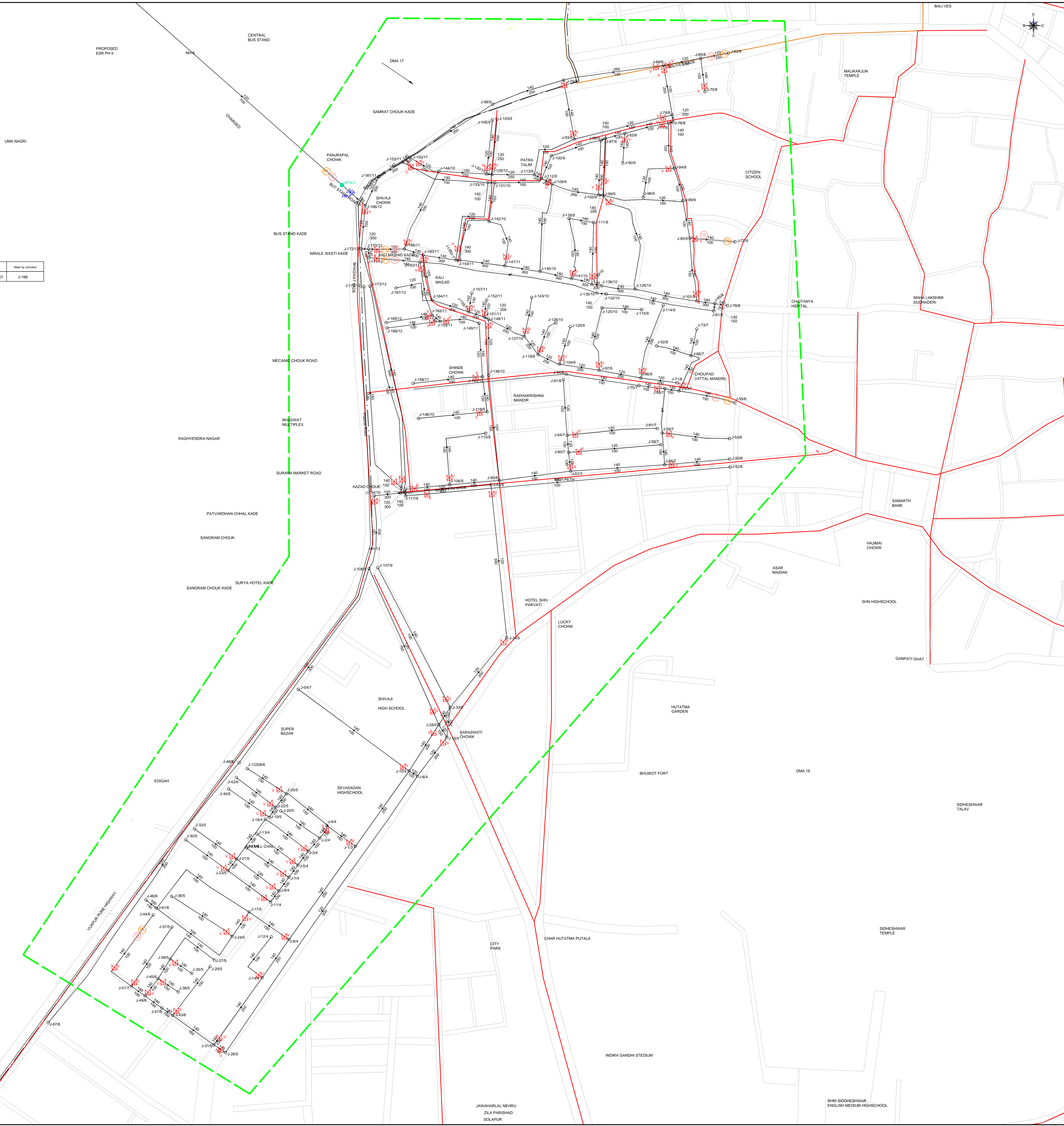

NOTES :-
 (1) DUE TO NO DEVELOPMENT IN FUTURE WATER PIPE LINE IS NOT PROPOSED ON OTHER SIDE OF SMART ROADS

REFERENCE DRG. NO.

- LEGEND :-**
- V = PROPOSED SLUICE VALVE
 - PRV = PROPOSED PRESSURE REDUCING VALVE
 - AV = PROPOSED AIR VALVE
 - PL = PROPOSED PRESSURE LOGGERS
 - DMA = DISTRICT METREING AREA
 - ESR = ELEVATED SERVICE RESERVOIR
 - BFM = PROPOSED BULK FLOW METRE
 - Q = PROPOSED WATER QUALITY LOGGERS
- JUNCTION NO. / PRESSURE IN METRE HAZEN WILLIAM'S CONSTANT(C) JUNCTION NO. / PRESSURE IN METRE
- | "C" VALUE | |
|-----------|----------------------|
| 100 | EXISTING CI PIPES |
| 120 | EXISTING DI K7 PIPES |
| 140 | PROPOSED DI K9 PIPES |
- SMART ROAD
 - ABD AREA BOUNDARY
 - DMA BOUNDARY

WTE DRAWING FOR COMMENTS / APPROVAL

SIGNATURE _____ DATE _____

| | | | | | |
|------|----------|-------------|-------|------|------|
| 4 | | | | | |
| 3 | | | | | |
| 2 | | | | | |
| 1 | 20.07.18 | FOR TENDER | BR | GNG | MS |
| 0 | 20.06.18 | FOR TENDER | BR | GNG | MS |
| Rev. | Date | Description | Drawn | Clk. | App. |

File name :- WTE-2297-HZ-ZONE 17 IMMEDIATE STAGE (2018).dwg

WTE Wadia Techno Engg. Services Ltd. Mumbai **LB** Louis Berger

Client: SOLAPUR CITY DEVELOPMENT CORPORATION LTD.

Project: DEVELOP, MANAGE & IMPLEMENT URBAN INFRASTRUCTURE SERVICES PROJECTS UNDER SMART CITY MISSION (SCM) IN SOLAPUR CITY.

Title: IMPROVEMENT OF WATER DISTRIBUTION SYSTEM FOR DMA 17 (UJANI) (IMMEDIATE STAGE - 2018) FOR ABD AREA

North of Scale: **A 0 NTS** **WTE-2297** 00 W 2.08 R1 1 1

Scale: Job no. Code Discipline Drg. no. Rev. Sheet of

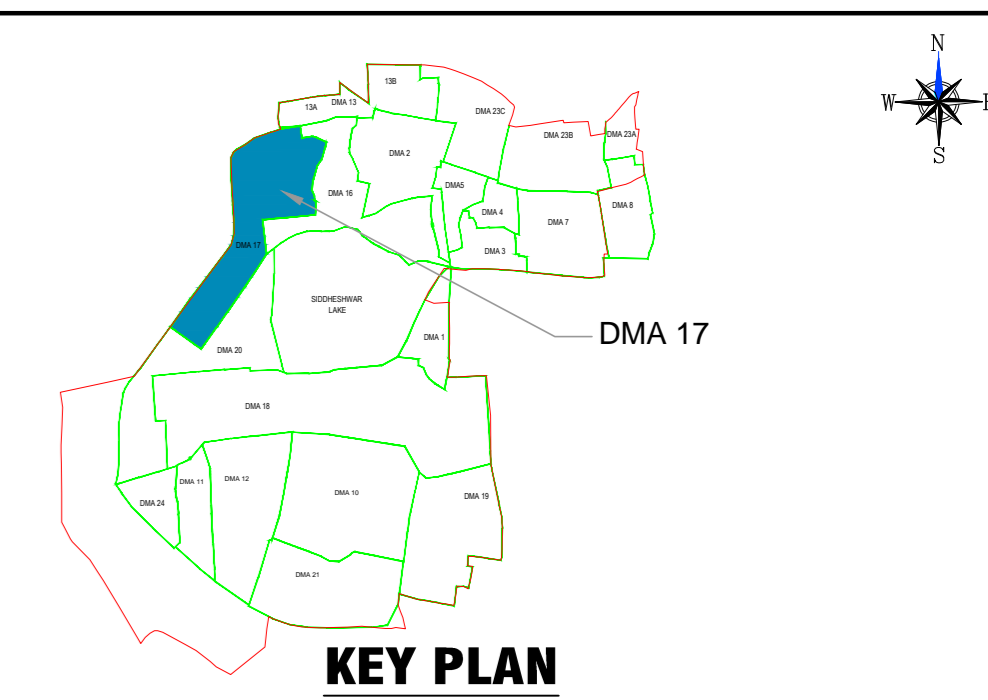
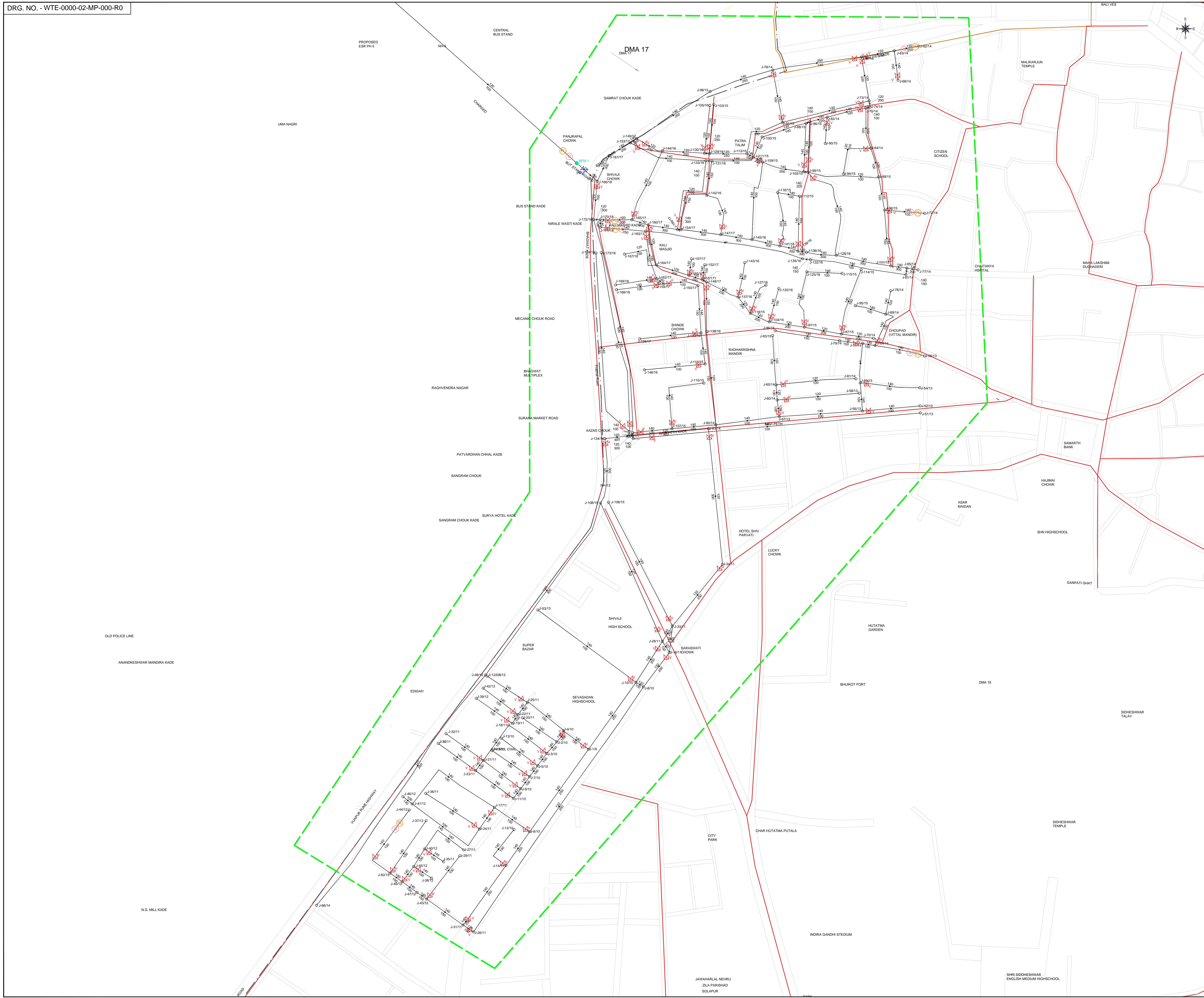

NOTES :-
 (A) DUE TO NO DEVELOPMENT IN FUTURE WATER PIPE LINE IS NOT PROPOSED ON OTHER SIDE OF SMART ROADS

REFERENCE DRG. NO.

- LEGEND :-**
- V = PROPOSED SLUICE VALVE
 - PRV = PROPOSED PRESSURE REDUCING VALVE
 - AV = PROPOSED AIR VALVE
 - PL = PROPOSED PRESSURE LOGGERS
 - DMA = DISTRICT METREING AREA
 - ESR = ELEVATED SERVICE RESERVOIR
 - BFM = PROPOSED BULK FLOW METRE
 - Q = PROPOSED WATER QUALITY LOGGERS
- JUNCTION NO. / PRESSURE IN METRE DIAZEN WILLIAMS CONSTANT(C) JUNCTION NO. / PRESSURE IN METRE
- DIAMETRE OF PIPE IN mm
- | C' VALUE | DIAMETRE OF PIPE IN mm |
|----------|------------------------|
| 100 | EXISTING CI PIPES |
| 120 | EXISTING DI KT PIPES |
| 140 | PROPOSED DI K9 PIPES |

- SMART ROAD
- - - ABD AREA BOUNDARY
- - - - - DMA BOUNDARY

WTE DRAWING FOR COMMENTS / APPROVAL

SIGNATURE _____ DATE _____

| | | | | | |
|------|----------|-------------|-------|------|------|
| 4 | | | | | |
| 3 | | | | | |
| 2 | | | | | |
| 1 | 20.07.18 | FOR TENDER | BR | GNG | MS |
| 0 | 30.06.18 | FOR TENDER | BR | GNG | MS |
| Rev. | Date | Description | Drawn | Chk. | App. |

File name: WTE-2297-HI-ZONE 17 ULTIMATE STAGE (2051).dwg

WTE Wadia Techno Engg. Services Ltd. Mumbai **LB** Louis Berger

Client: **SOLAPUR CITY DEVELOPMENT CORPORATION LTD.**

Project: DESIGN, DEVELOP, MANAGE & IMPLEMENT URBAN INFRASTRUCTURE SERVICES PROJECTS UNDER SMART CITY MISSION (SCM) IN SOLAPUR CITY.

Title: **IMPROVEMENT OF WATER DISTRIBUTION SYSTEM FOR DMA 17 (UJANI) (ULTIMATE STAGE - 2051) FOR ABD AREA**

North of Scale: **A 0 NTS** **WTE-2297** 00 W 2.18 R1 1 1

Scale: _____ Job no. _____ Code _____ Discipline _____ Design _____ Rev. _____ Sheet _____ of _____

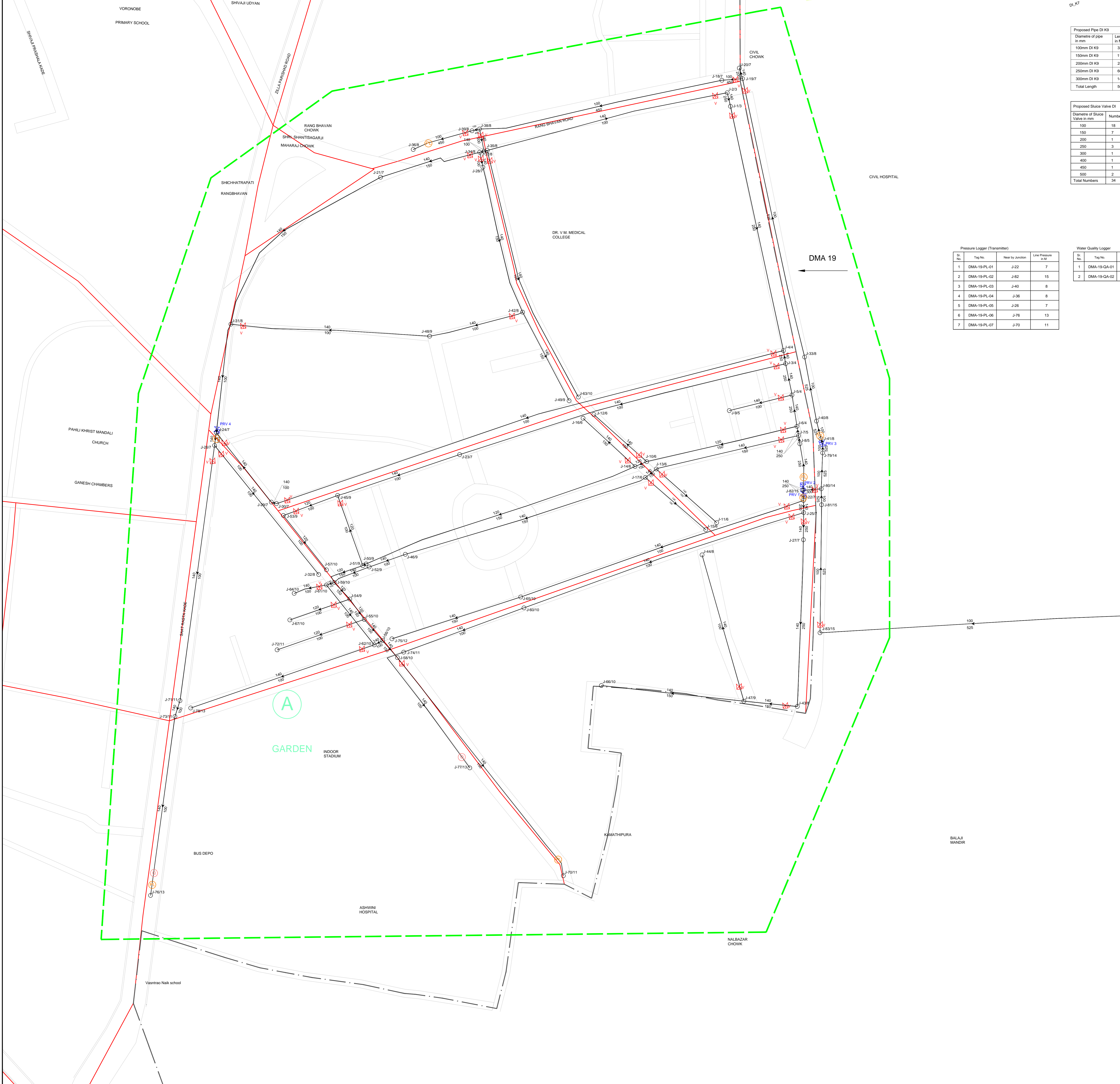

For DMA 19

| Proposed Pipe DI K9 | Length of ppo in M |
|---------------------|--------------------|
| 100mm DI K9 | 3251 |
| 150mm DI K9 | 1146 |
| 200mm DI K9 | 25 |
| 250mm DI K9 | 609 |
| 300mm DI K9 | 14 |
| Total Length | 5045 |

| Proposed Sluice Valve DI | Numbers |
|--------------------------|---------|
| 150 | 18 |
| 200 | 7 |
| 250 | 1 |
| 300 | 1 |
| 400 | 1 |
| 450 | 1 |
| 500 | 2 |
| Total Numbers | 34 |

| Bulk Flow Meter | |
|-----------------|-----|
| Description | No. |
| BFM | 1 |

| Pressure Reducing Valve (PRV) | | | |
|-------------------------------|------------------------|-------------------------------|-----------------------------|
| Description | Diameter of Pipe in mm | Initial Pressure Setting in M | Final Pressure Setting in M |
| PRV 1 | 200 | 15 | 7 |
| PRV 2 | 250 | 15 | 5 |
| PRV 3 | 450 | 525 | 14 |
| PRV 4 | 100 | 8 | 7 |

| Pressure Logger (Transmitter) | |
|-------------------------------|--------------|
| Sl. No. | Tag No. |
| 1 | DMA-19-PL-01 |
| 2 | DMA-19-PL-02 |
| 3 | DMA-19-PL-03 |
| 4 | DMA-19-PL-04 |
| 5 | DMA-19-PL-05 |
| 6 | DMA-19-PL-06 |
| 7 | DMA-19-PL-07 |

| Water Quality Logger | |
|----------------------|--------------|
| Sl. No. | Tag No. |
| 1 | DMA-19-QA-01 |
| 2 | DMA-19-QA-02 |

| Flow Meter | |
|------------|--------------|
| Sl. No. | Tag No. |
| 1 | DMA-19-FT-01 |

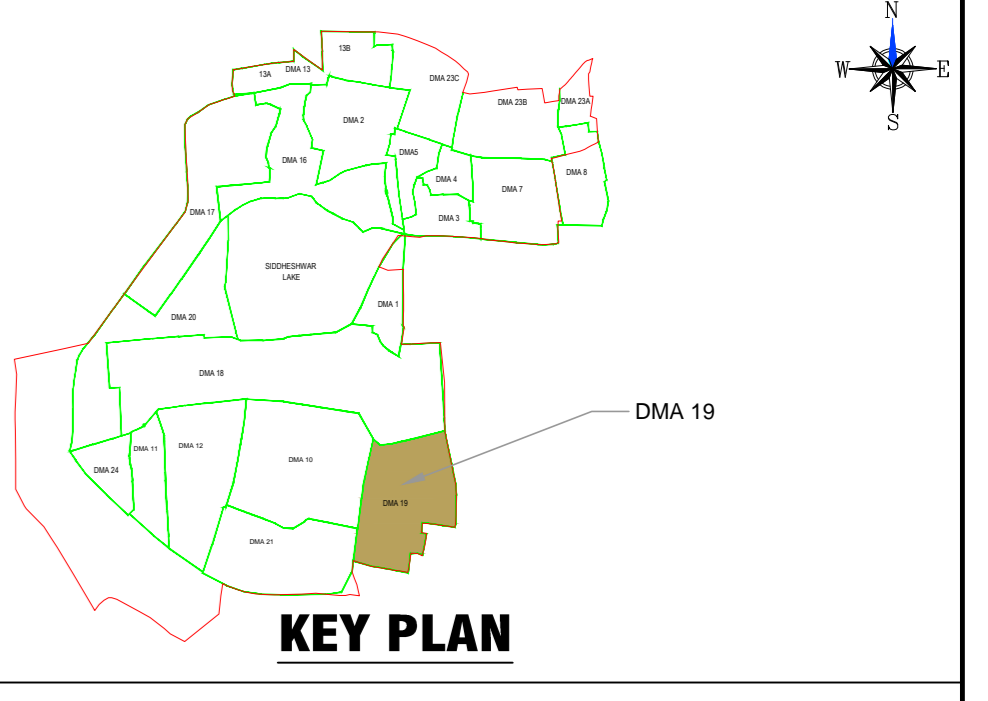

NOTES :-
 ⓐ DUE TO NO DEVELOPMENT IN FUTURE WATER PIPE LINE IS NOT PROPOSED ON OTHER SIDE OF SMART ROADS

REFERENCE DRG. NO.

- LEGEND :-**
- V = PROPOSED SLUICE VALVE
 - PRV = PROPOSED PRESSURE REDUCING VALVE
 - AV = PROPOSED AIR VALVE
 - PL = PROPOSED PRESSURE LOGGERS
 - DMA = DISTRICT METREING AREA
 - ESR = ELEVATED SERVICE RESERVOIR
 - BFM = PROPOSED BULK FLOW METRE
 - Q = PROPOSED WATER QUALITY LOGGERS
- JUNCTION NO. / PRESSURE IN METRE HAZEN WILLIAM'S CONSTANT(C) JUNCTION NO. / PRESSURE IN METRE
- | DIAMETRE OF PIPE IN mm | |
|------------------------|----------------------|
| C' VALUE | |
| 100 | EXISTING CI PIPES |
| 120 | EXISTING DI K7 PIPES |
| 140 | PROPOSED DI K9 PIPES |
- SMART ROAD
 - ABD AREA BOUNDARY
 - DMA BOUNDARY

Z19: HIGH LEVEL ZONE ESR 1004

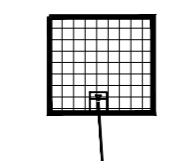

WTE DRAWING FOR COMMENTS / APPROVAL

SIGNATURE _____ DATE _____

| | | | | | |
|-----|----------|-------------|-------|------|--------|
| 4 | | | | | |
| 3 | | | | | |
| 2 | | | | | |
| 1 | 20.07.18 | FOR TENDER | | BR | GNG MS |
| 0 | 30.06.18 | FOR TENDER | | BR | GNG MS |
| Rev | Date | Description | Drawn | Chk. | App. |

File name: WTE-2297-HZ-ZONE 19 IMMEDIATE STAGE (2018).dwg

WTE Wadia Techno Engg. Services Ltd. Mumbai

Louis Berger

Client: SOLAPUR CITY DEVELOPMENT CORPORATION LTD.

Project: DESIGN, DEVELOP, MANAGE & IMPLEMENT URBAN INFRASTRUCTURE SERVICES PROJECTS UNDER SMART CITY MISSION (SCM) IN SOLAPUR CITY.

Title: IMPROVEMENT OF WATER DISTRIBUTION SYSTEM FOR DMA 19 (HIGH LEVEL ESR) (IMMEDIATE STAGE - 2018) FOR ABD AREA

North of Scale: **A 0 NTS** **WTE-2297** 00 W 2.09 R1 1 1

Scale Job no. Code Discipline Drgno. Rev. Sheet of

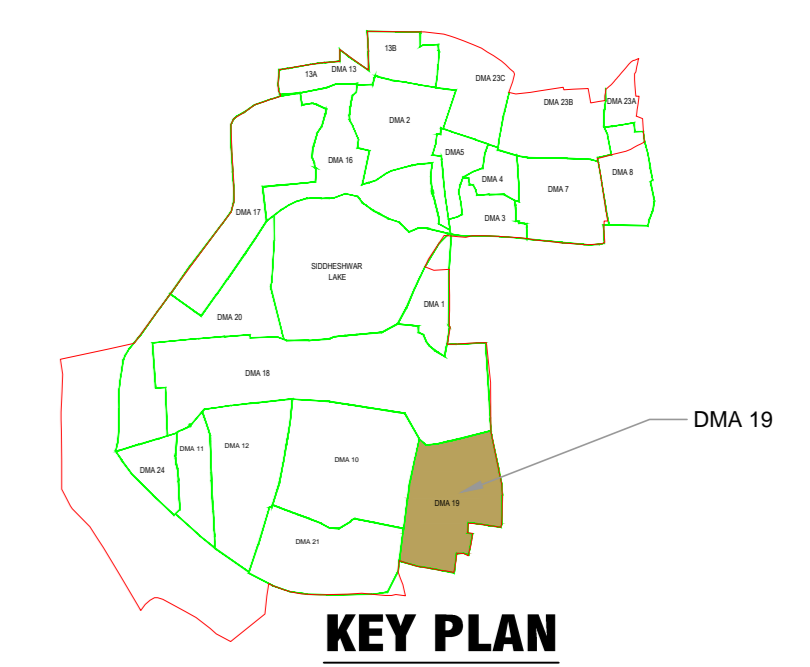
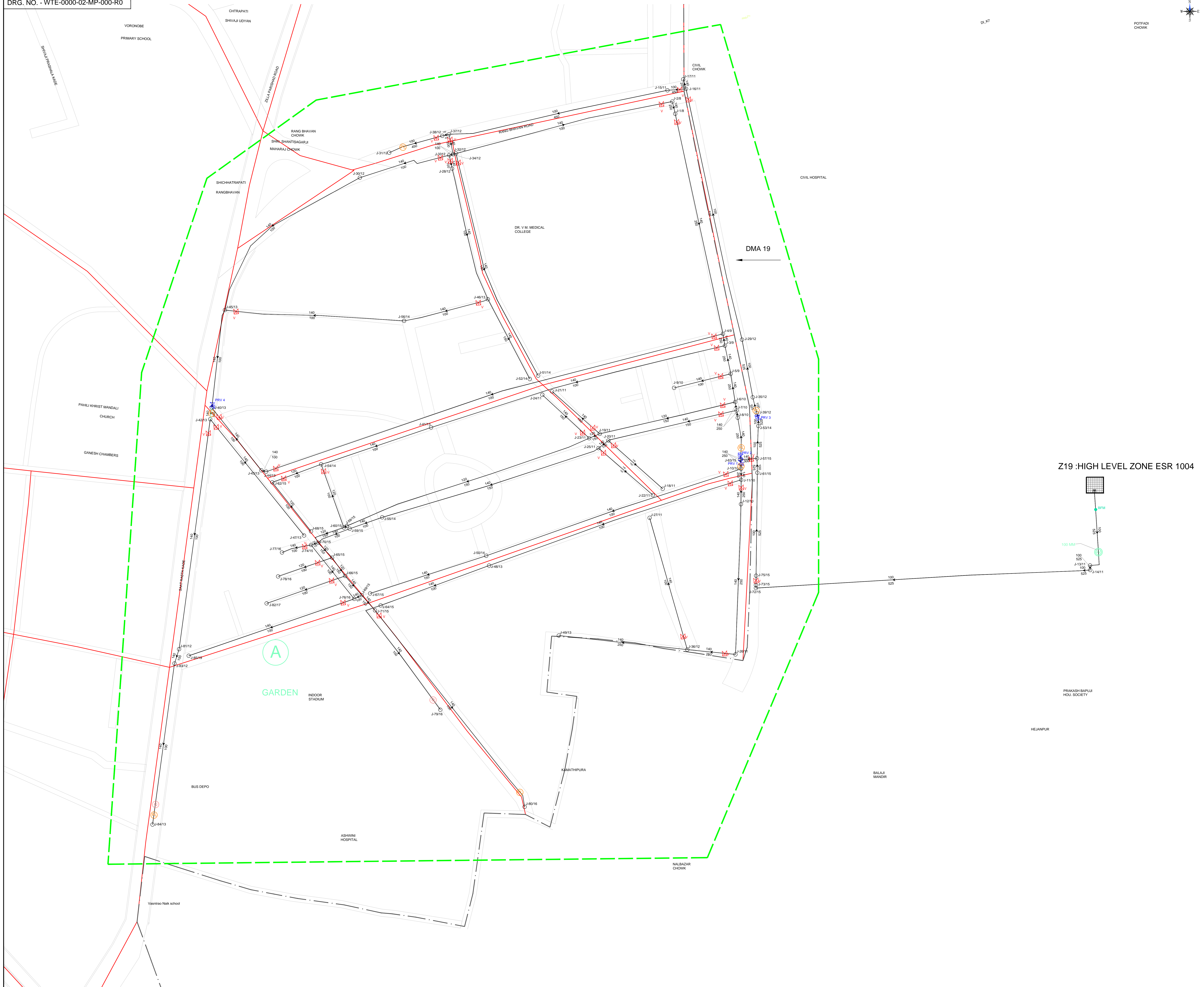

NOTES :-
 (A) DUE TO NO DEVELOPMENT IN FUTURE WATER PIPE LINE IS NOT PROPOSED ON OTHER SIDE OF SMART ROADS

REFERENCE DRG. NO.

- LEGEND :-**
- V = PROPOSED SLUICE VALVE
 - PRV = PROPOSED PRESSURE REDUCING VALVE
 - AV = PROPOSED AIR VALVE
 - PL = PROPOSED PRESSURE LOGGERS
 - DMA = DISTRICT METREING AREA
 - ESR = ELEVATED SERVICE RESERVOIR
 - BFM = PROPOSED BULK FLOW METRE
 - Q = PROPOSED WATER QUALITY LOGGERS
- JUNCTION NO. / PRESSURE IN METRE HAZEN WILLIAM'S CONSTANT(C) JUNCTION NO. / PRESSURE IN METRE
- | "C" VALUE | |
|-----------|----------------------|
| 100 | EXISTING CI PIPES |
| 120 | EXISTING DI KI PIPES |
| 140 | PROPOSED DI K9 PIPES |
- DIAMETRE OF PIPE IN mm
- SMART ROAD
 - ABD AREA BOUNDARY
 - DMA BOUNDARY

Z19 :HIGH LEVEL ZONE ESR 1004

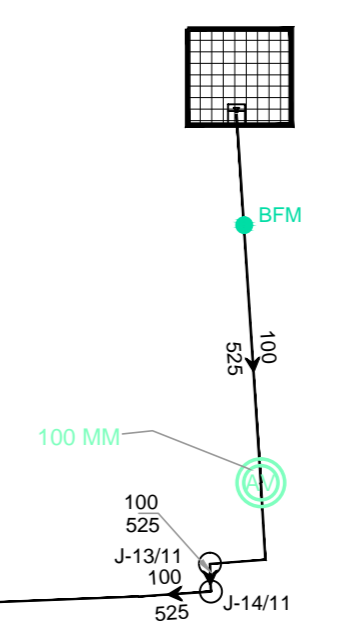

WTE DRAWING FOR COMMENTS / APPROVAL

SIGNATURE _____ DATE _____

| | | | | | |
|------|----------|-------------|-------|------|------|
| 4 | | | | | |
| 3 | | | | | |
| 2 | | | | | |
| 1 | 20.07.18 | FOR TENDER | BR | GNG | MS |
| 0 | 30.06.18 | FOR TENDER | BR | GNG | MS |
| Rev. | Date | Description | Drawn | Clk. | App. |

File name : WTE-2297-HZ-ZONE 19 ULTIMATE STAGE (2051).dwg

WTE Wadia Techno Engg. Services Ltd. Mumbai

Louis Berger

Client: SOLAPUR CITY DEVELOPMENT CORPORATION LTD.

Project: DESIGN, DEVELOP, MANAGE & IMPLEMENT URBAN INFRASTRUCTURE SERVICES PROJECTS UNDER SMART CITY MISSION (SCM) IN SOLAPUR CITY.

Title: IMPROVEMENT OF WATER DISTRIBUTION SYSTEM FOR DMA 19 (HIGH LEVEL ESR) (ULTIMATE STAGE - 2051) FOR ABD AREA

North of Scale: **A 0 NTS WTE-2297** 00 W 2.19 R1 1 1

Scale: Job no. Code Discipline Drg.no. Rev. Sheet of

For DMA 23/C

| Proposed Pipe DI K9 | |
|------------------------|---------------------|
| Diameter of pipe in mm | Length of pipe in m |
| 100mm | 3101 |
| 150mm | 879 |
| 200mm | 545 |
| 250mm | 175 |
| Total Length | 4700 |

| Bulk Flow metre | | | |
|-----------------|------------------------------|-----|---------------------------|
| Description | Diameter of Flow Metre in mm | Nos | Type of flow metre |
| BFM 3 | 150 | 1 | Electromagnetic full bore |
| BFM 4 | 150 | 1 | Electromagnetic full bore |

| Proposed Sluice Valve DI | |
|--------------------------------|-----------|
| Diameter of Sluice Valve in mm | Numbers |
| 150 | 28 |
| 200 | 2 |
| 250 | 2 |
| 300 | 1 |
| Total Numbers | 33 |

| Pressure Reducing Valve (PRV) | | | | | |
|-------------------------------|-----------------------|------------------------|-------------------------------|------|------|
| Description | Diameter of PRV in mm | Diameter of Pipe in mm | Initial Pressure Setting in M | | |
| | | | 2018 | 2021 | 2024 |
| PRV 3 | 300 | 350 | 13 | 12 | 16 |
| PRV 4 | 300 | 300 | 12 | 11 | 20 |

| | |
|-----------------------------|---|
| No of Pressure Loggers | 6 |
| No of Water Quality Loggers | 1 |

| Pressure Logger (Transmitter) | | | |
|-------------------------------|---------------|------------------|---------------|
| Sr. No. | Tag No. | Near to Junction | Line Pressure |
| 1 | DMA-23A-PL-01 | J-432 | 16 |
| 2 | DMA-23A-PL-02 | J-431 | 15 |
| 3 | DMA-23A-PL-03 | J-311 | 9 |
| 4 | DMA-23B-PL-01 | J-428 | 12 |
| 5 | DMA-23B-PL-02 | J-427 | 12 |
| 6 | DMA-23C-PL-03 | J-317 | 9 |
| 7 | DMA-23B-PL-04 | J-152 | 6 |
| 8 | DMA-23B-PL-05 | J-409 | 11 |
| 9 | DMA-23C-PL-01 | J-100 | 5 |
| 10 | DMA-23C-PL-02 | J-271 | 8 |
| 11 | DMA-23C-PL-03 | J-29 | 3 |
| 12 | DMA-23C-PL-04 | J-117 | 5 |
| 13 | DMA-23C-PL-05 | J-1 | 1 |
| 14 | DMA-23C-PL-06 | J-428 | 12 |

| Water Quality Logger | | | |
|----------------------|---------------|------------------|---------------|
| Sr. No. | Tag No. | Near to Junction | Line Pressure |
| 1 | DMA-23A-QA-01 | J-299 | |
| 2 | DMA-23A-QA-02 | J-391 | |
| 3 | DMA-23B-QA-01 | J-427 | |
| 4 | DMA-23B-QA-02 | J-422 | |
| 5 | DMA-23B-QA-03 | J-409 | |
| 6 | DMA-23C-QA-01 | J-271 | |

| Flow Metre | | | |
|------------|---------------|------------------|---------------|
| Sr. No. | Tag No. | Near to Junction | Line Pressure |
| 1 | DMA-23A-FT-01 | J-431 | |
| 2 | DMA-23B-FT-01 | J-432 | |
| 3 | DMA-23C-FT-01 | J-416 | |
| 4 | DMA-23C-FT-02 | J-426 | |
| 5 | DMA-23C-FT-03 | J-428 | |

For DMA 23/B

| Proposed Pipe DI K9 | |
|------------------------|---------------------|
| Diameter of pipe in mm | Length of pipe in m |
| 100mm | 7586 |
| 150mm | 747 |
| 200mm | 114 |
| 250mm | 703 |
| 300mm | 261 |
| 350mm | 36 |
| Total Length | 9449 |

| Bulk Flow metre | | | |
|-----------------|------------------------------|-----|---------------------------|
| Description | Diameter of Flow Metre in mm | Nos | Type of flow metre |
| BFM 2 | 150 | 1 | Electromagnetic full bore |

| Pressure Reducing Valve (PRV) | | | | | |
|-------------------------------|-----------------------|------------------------|-------------------------------|------|------|
| Description | Diameter of PRV in mm | Diameter of Pipe in mm | Initial Pressure Setting in M | | |
| | | | 2018 | 2021 | 2024 |
| PRV 2 | 650 | 700 | 20 | 5 | 20 |

| | |
|-----------------------------|---|
| No of Pressure Loggers | 5 |
| No of Water Quality Loggers | 3 |

| Proposed Sluice Valve DI | |
|--------------------------------|-----------|
| Diameter of Sluice Valve in mm | Numbers |
| 100 | 67 |
| 150 | 4 |
| 200 | 1 |
| 600 | 1 |
| Total Numbers | 73 |

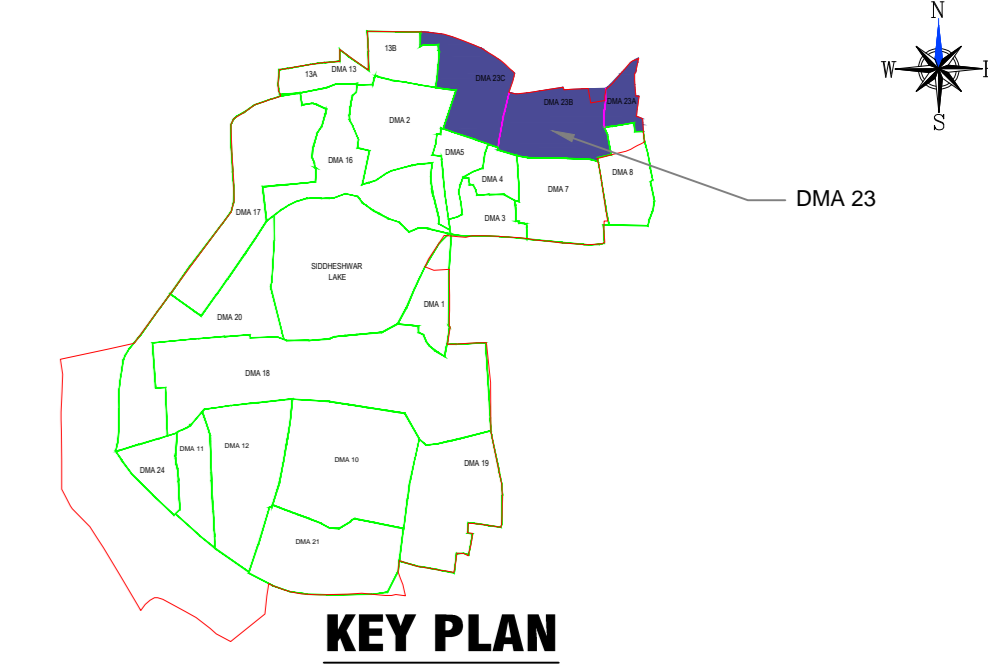
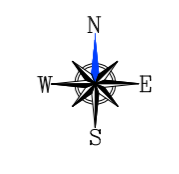

NOTES :-
 (A) DUE TO NO DEVELOPMENT IN FUTURE WATER PIPE LINE IS NOT PROPOSED ON OTHER SIDE OF SMART ROADS

REFERENCE DRG. NO.

- LEGEND :-**
- V = PROPOSED SLUICE VALVE
 - PRV = PROPOSED PRESSURE REDUCING VALVE
 - AV = PROPOSED AIR VALVE
 - PL = PROPOSED PRESSURE LOGGERS
 - DMA = DISTRICT METREING AREA
 - ESR = ELEVATED SERVICE RESERVOIR
 - BFM = PROPOSED BULK FLOW METRE
 - Q = PROPOSED WATER QUALITY LOGGERS
 - JUNCTION NO. / PRESSURE HAZEN WILLIAMS CONSTANT(C) DIAMETRE OF PIPE IN mm
- | C' VALUE | |
|----------|----------------------|
| 100 | EXISTING CI PIPES |
| 120 | EXISTING DI K7 PIPES |
| 140 | PROPOSED DI K9 PIPES |
- SMART ROAD
 - ABD AREA BOUNDARY
 - DMA BOUNDARY



For DMA 23/A

| Proposed Pipe DI K9 | |
|------------------------|---------------------|
| Diameter of pipe in mm | Length of pipe in m |
| 100mm | 1231 |
| 150mm | 300 |
| 200mm | 179 |
| Total Length | 1710 |

| Bulk Flow metre | | | |
|-----------------|------------------------------|-----|---------------------------|
| Description | Diameter of Flow Metre in mm | Nos | Type of flow metre |
| BFM 1 | 100 | 1 | Electromagnetic full bore |

| Pressure Reducing Valve (PRV) | | | | | |
|-------------------------------|-----------------------|------------------------|-------------------------------|------|------|
| Description | Diameter of PRV in mm | Diameter of Pipe in mm | Initial Pressure Setting in M | | |
| | | | 2018 | 2021 | 2024 |
| PRV 1 | 150 | 200 | 15 | 7 | 15 |

| Proposed Sluice Valve DI | |
|--------------------------------|-----------|
| Diameter of Sluice Valve in mm | Numbers |
| 100 | 9 |
| 150 | 1 |
| Total Numbers | 10 |

| | |
|-----------------------------|---|
| No of Pressure Loggers | 3 |
| No of Water Quality Loggers | 2 |

| Air Valve (AV) | |
|-----------------------------|-----|
| Diameter of Air Valve in mm | Nos |
| 150 | 1 |

| | | | | | |
|---|----------|------------|--|----|--------|
| 4 | | | | | |
| 3 | | | | | |
| 2 | | | | | |
| 1 | 20.07.18 | FOR TENDER | | BR | GNG MS |
| 0 | 30.06.18 | FOR TENDER | | BR | GNG MS |

File name: WTE-2297-HI-ZONE 23 IMMEDIATE STAGE (2018).dwg

Wadia Techno Engg. Services Ltd. | **Louis Berger**

Client: **SOLAPUR CITY DEVELOPMENT CORPORATION LTD.**

Project: **DESIGN, DEVELOP, MANAGE & IMPLEMENT URBAN INFRASTRUCTURE SERVICES PROJECTS UNDER SMART CITY MISSION (SCM) IN SOLAPUR CITY**

Title: **IMPROVEMENT OF WATER DISTRIBUTION SYSTEM FOR DMA 23 AT (IMMEDIATE STAGE - 2018) FOR ABD AREA**

North: **A 0 NTS** | Scale: **WTE-2297** | Job no.: **00** | Code: **W** | Discipline: **2.10** | Drg. no.: **R1** | Rev.: **1** | Sheet: **1** | Cf

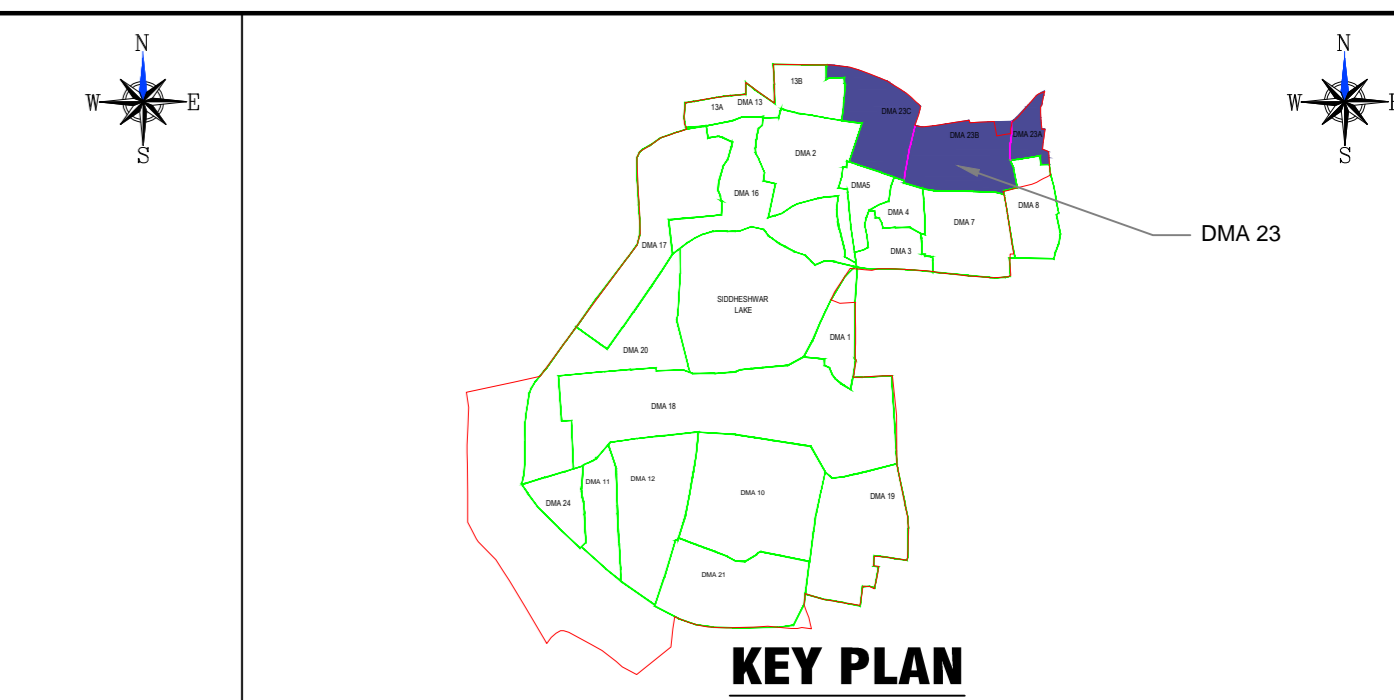

NOTES :-
 (A) DUE TO NO DEVELOPMENT IN FUTURE WATER PIPE LINE IS NOT PROPOSED ON OTHER SIDE OF SMART ROADS

REFERENCE DRG. NO.

- LEGEND :-**
- V = PROPOSED SLUICE VALVE
 - PRV = PROPOSED PRESSURE REDUCING VALVE
 - AV = PROPOSED AIR VALVE
 - PL = PROPOSED PRESSURE LOGGERS
 - DMA = DISTRICT METRING AREA
 - ESR = ELEVATED SERVICE RESERVOIR
 - BFM = PROPOSED BULK FLOW METRE
 - Q = PROPOSED WATER QUALITY LOGGERS
- JUNCTION NO. / PRESSURE IN METRE JUNCTION NO. / PRESSURE IN METRE
- HAZEN WILLIAMS CONSTANT (C)
- DIAMETRE OF PIPE IN mm
- | C' VALUE | DIAMETRE OF PIPE IN mm |
|----------|------------------------|
| 100 | EXISTING CI PIPES |
| 120 | EXISTING DI K7 PIPES |
| 140 | PROPOSED DI K9 PIPES |
- SMART ROAD
 - ABD AREA BOUNDARY
 - DMA BOUNDARY



| | | | | | |
|------|----------|-------------|-------|------|------|
| 4 | | | | | |
| 3 | | | | | |
| 2 | | | | | |
| 1 | 20.07.18 | FOR TENDER | BR | GNG | MS |
| 0 | 30.06.18 | FOR TENDER | BR | GNG | MS |
| Rev. | Date | Description | Drawn | Chk. | App. |

File name :- WTE-2297-HI_ZONE 23 ULTIMATE STAGE (2051).dwg

WTE Wadia Techno Engg. Services Ltd. Mumbai **LB** Louis Berger

Client: **SOLAPUR CITY DEVELOPMENT CORPORATION LTD.**

Project: **DESIGN, DEVELOP, MANAGE & IMPLEMENT URBAN INFRASTRUCTURE SERVICES PROJECTS UNDER SMART CITY MISSION (SCM) IN SOLAPUR CITY**

Title: **IMPROVEMENT OF WATER DISTRIBUTION SYSTEM FOR DMA 23 (ULTIMATE STAGE - 2051) FOR ABD AREA**

North of **A 0 NTS** **WTE-2297** 00 W 2.21 R1 1 1

Scale: _____ Job no. _____ Code _____ Discipline _____ Drg. no. _____ Rev. _____ Sheet _____ of _____

Solapur ABD Area Sewerage System- Zone1:Sewer Districts 1 and 2

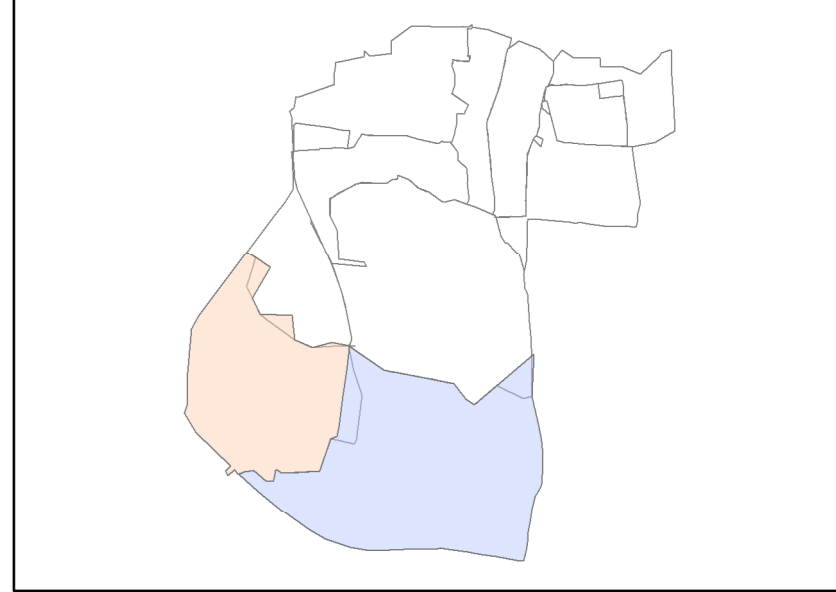

Key Plan

Legend

- Contours
- Water Body
- Road

Sewer Districts

- D1
- D2
- D3
- D4
- D5
- D6
- D7
- D8
- D9
- D10
- D11

Manhole Diameter (mm)

- R 1200
- R 1500

Conduit Diameter (mm)

- DWC 200
- RCC NP3 300
- 350
- 400
- 500
- 600, 700
- 800

Outfall Summary

| Label | Elevation (Ground) (m) | Elevation (Invert) (m) |
|----------|------------------------|------------------------|
| O-1 | 454.81 | 448.5 |
| O-MGMIII | 457 | 451.5 |

Pipe Summary (without SMC trunk mains)

| District | DWC | | Conduit Summary Table | | | | | | | | Grand Total |
|--------------------|--------------|--------------|-----------------------|-----------|----------|-----------|-----------|-----------|-----------|------------|--------------|
| | 200 | Total | 200 | 300 | 400 | 500 | 600 | 700 | 800 | Total | |
| 1 | 19336 | 19336 | 200 | 16 | | 14 | 8 | 22 | 20 | 80 | |
| 2 | 18288 | 18288 | 213 | 57 | | | | | | 270 | |
| Grand Total | 37824 | 37624 | 213 | 73 | 0 | 14 | 22 | 22 | 20 | 350 | 37974 |

Manhole Summary

| Sewer District | Diameter (mm) | | Grand Total |
|----------------|---------------|------|-------------|
| | 1200 | 1500 | |
| 1 | 789 | 142 | 931 |
| 2 | 595 | 193 | 788 |

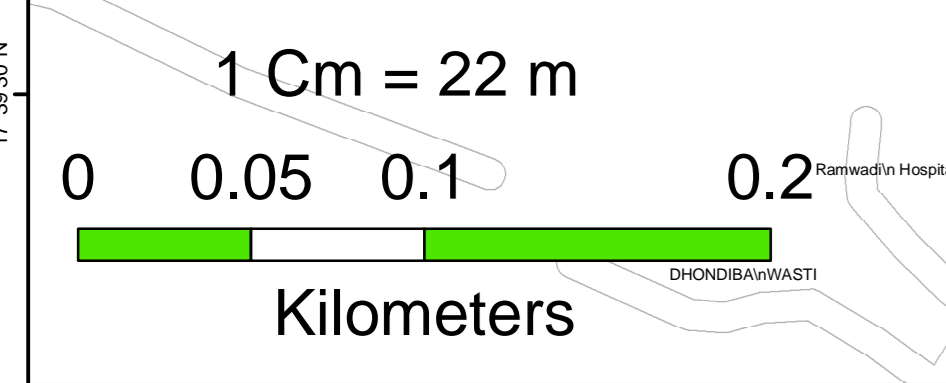
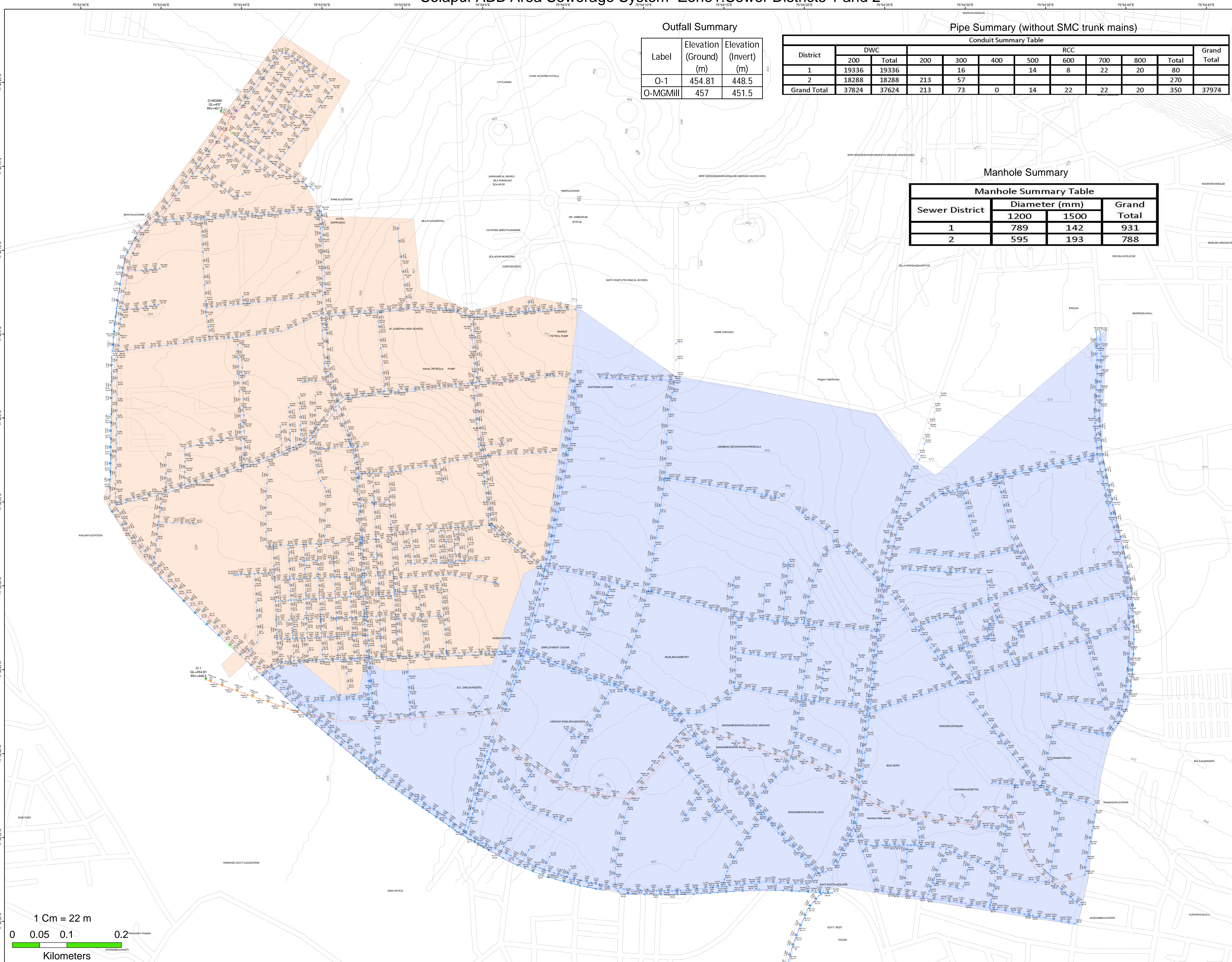

| Rev. | Date | Description | Drawn | Chk. | App. |
|------|------|-------------|-------|------|------|
| | | | | | |

| | |
|--|---|
| Wadia Techno Engg. Services Ltd. Mumbai | Louis Berger |
| Client: SOLAPUR CITY DEVELOPMENT CORPORATION LTD. | |
| Project: Solapur ABD Area Sewerage System | |
| Title: Zone1:Sewer Districts 1 and 2 | |
| No. A1 Scale NTS | Job No. WTE-2297 Date 0 W Drawn R0 Chk. 1 App. 1 |

Solapur ABD Area Sewerage System- Zone2:Sewer Districts 3, 4, 5 and 6

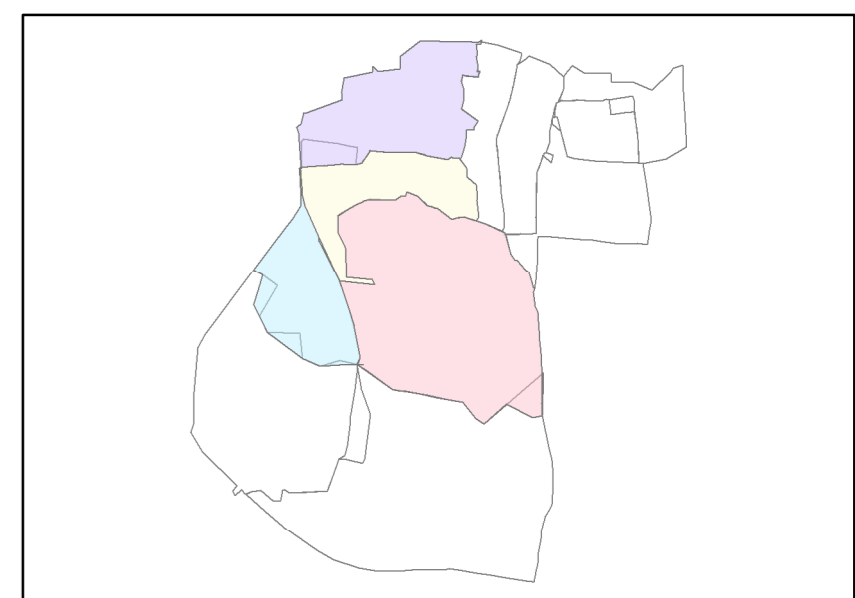
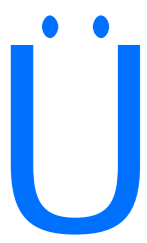

Key Plan

Legend

- Contours
- Water Body
- Road

Sewer Districts

- D1
- D2
- D3
- D4
- D5
- D6
- D7
- D8
- D9
- D10
- D11

Manhole Diameter (mm)

- 1200
- 1500

Conduit Diameter (mm)

- DWC**
- 200
- RCC NP3**
- 300
- 350
- 400
- 500
- 600, 700
- 800

Pipe Summary (without SMC trunk mains)

| District | DWC | | RCC | | | | | | | Grand Total | |
|--------------------|--------------|--------------|-------------|------------|----------|----------|----------|----------|----------|-------------|--------------|
| | 200 | Total | 200 | 300 | 400 | 500 | 600 | 700 | 800 | | |
| 3 | 6338 | 6338 | | 61 | 7 | | | | | | 68 |
| 4 | 8755 | 8755 | | 22 | | | | | | | 22 |
| 5 | 10069 | 10069 | 1298 | 792 | | | | | | | 2090 |
| 6 | 13116 | 13116 | | 11 | | | | | | | 11 |
| Grand Total | 38278 | 38278 | 1298 | 886 | 7 | 0 | 0 | 0 | 0 | 0 | 40469 |

Manhole Summary

| Sewer District | Diameter (mm) | | Grand Total |
|--------------------|---------------|------------|-------------|
| | 1200 | 1500 | |
| 3 | 232 | 59 | 291 |
| 4 | 424 | 22 | 446 |
| 5 | 328 | 201 | 529 |
| 6 | 607 | 63 | 670 |
| Grand Total | 1591 | 345 | 1936 |

Outfall Summary

| Label | Elevation (Ground) (m) | Elevation (Invert) (m) |
|-------|------------------------|------------------------|
| O-2 | 455.9 | 454.5 |
| O-4 | 453.36 | 448.3 |

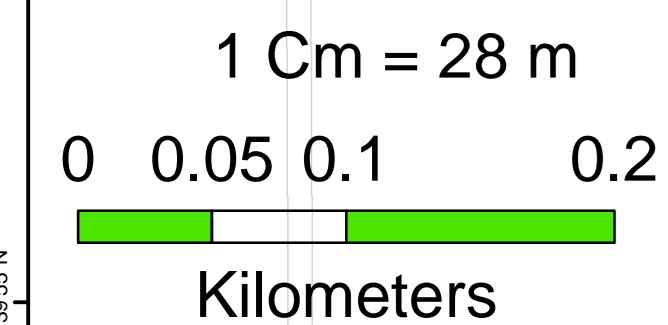

| Rev. | Date | Description | Drawn | Chk. | App. |
|------|------|-------------|-------|------|------|
| | | | | | |
| | | | | | |

| | | |
|------------|---|--------------|
| File Name: | Wadia Techno Engg. Services Ltd. Mumbai | Louis Berger |
| Client: | SOLAPUR CITY DEVELOPMENT CORPORATION LTD. | |
| Project: | Solapur ABD Area Sewerage System | |
| Title: | Zone2: Sewer Districts 3, 4, 5 and 6 | |
| Scale: | A1 NTS | WTE-2297 |
| Scale: | 0 | W |
| Scale: | R0 | 1 |
| Scale: | 1 | 1 |

Solapur ABD Area Sewerage System- Zones3:Sewer Districts 7, 8, 9, 10 and 11

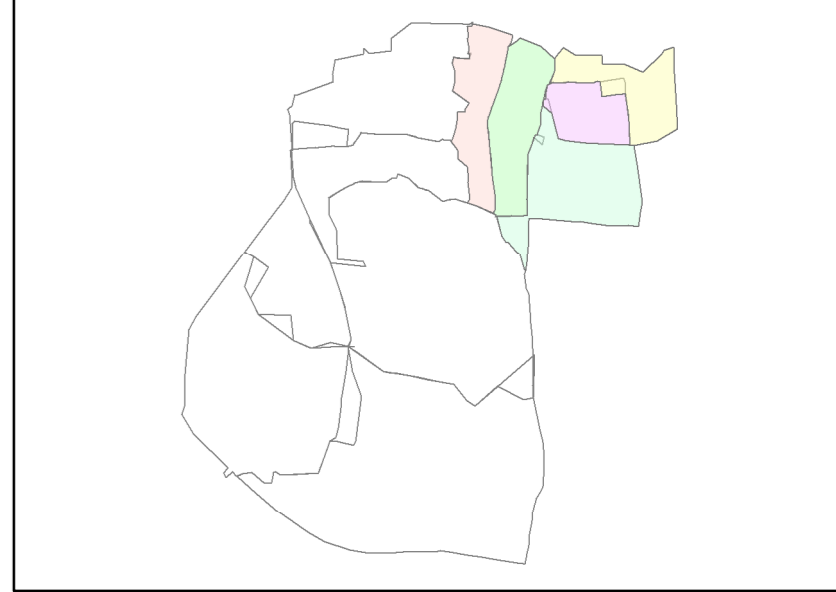

Key Plan

Legend

- Contours
- Water Body
- Road

Sewer Districts

- D1
- D2
- D3
- D4
- D5
- D6
- D7
- D8
- D9
- D10
- D11

Manhole Diameter (mm)

- 1200
- 1500

Conduit Diameter (mm)

- All diameters are linear
- DWC**
 - 200
 - RCC NP3**
 - 300
 - 350
 - 400
 - 500
 - 600, 700
 - 800

Outfall Summary

| Label | Elevation (Ground) (m) | Elevation (Invert) (m) |
|-------|------------------------|------------------------|
| O-3 | 460 | 457 |
| O-5 | 458.55 | 452 |

Manhole Summary

| Sewer District | Diameter (mm) | | Grand Total |
|--------------------|---------------|------------|-------------|
| | 1200 | 1500 | |
| 7 | 331 | 14 | 345 |
| 8 | 417 | 19 | 436 |
| 9 | 222 | 6 | 228 |
| 10 | 252 | 20 | 272 |
| 11 | 422 | 50 | 472 |
| Grand Total | 1644 | 109 | 1753 |

Pipe Summary (without SMC trunk mains)

| District | DWC | | RCC | | | | | Total | Grand Total |
|--------------|--------------|--------------|-----|-----|-----|-----|-----|-------|--------------|
| | 200 | Total | 300 | 400 | 500 | 600 | 675 | | |
| 7 | 6603 | 6603 | | | | | | | 6603 |
| 8 | 6988 | 6988 | | | | | | | 6988 |
| 9 | 4614 | 4614 | | | | | | | 4614 |
| 10 | 4899 | 4899 | | | | | | | 4899 |
| 11 | 9931 | 9931 | | | | | | | 9931 |
| Total | 33035 | 33035 | | | | | | | 33035 |

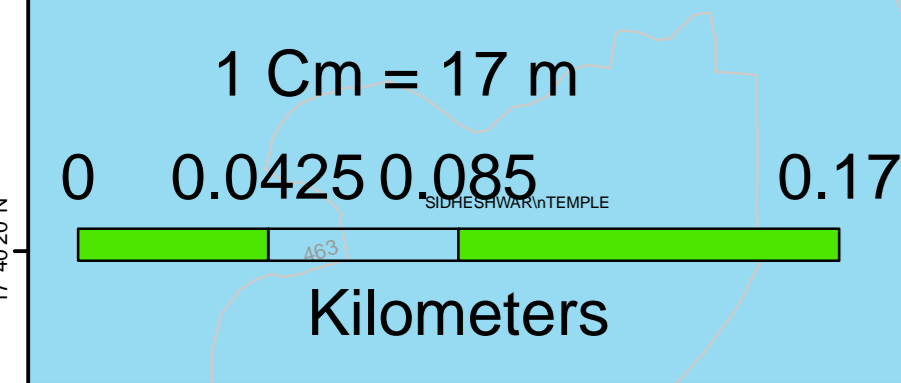
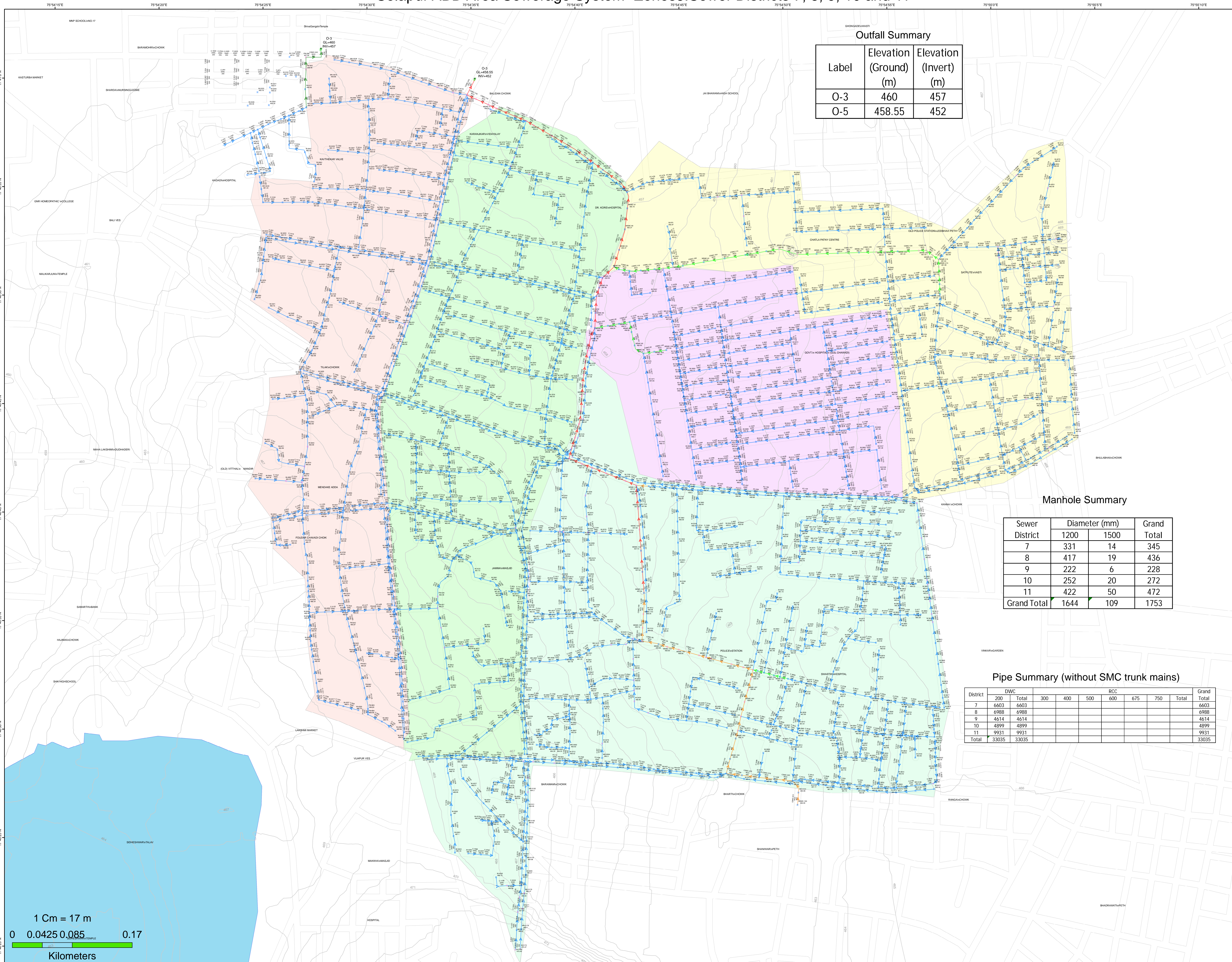

| Rev. | Date | Description | Drawn | Chk. | App. |
|------|------|-------------|-------|------|------|
| | | | | | |

File Name: _____
 Client: **Wadia Techno Engg. Services Ltd. Mumbai** / **Louis Berger**
 Project: **SOLAPUR CITY DEVELOPMENT CORPORATION LTD.**
Solapur ABD Area Sewerage System
 Title: **Zones3: Sewer Districts 7, 8, 9, 10 and 11**
 No. of Sheets: **A1** / **WTE-2297** / **0** / **W** / **RO** / **1** / **1**
 Scale: _____

Solapur ABD Area Sewerage System- All 3 Zones and 11 Sewer Districts



Key Plan

Legend

- Contours
- Water Body
- Road

- To be laid on both sides of the roads
- SMC Trunk Mains already laid

Sewer Districts

- D1
- D2
- D3
- D4
- D5
- D6
- D7
- D8
- D9
- D10
- D11

Manhole Diameter (mm)

- R 1200
- R 1500

smc_sewerage-zones

Conduit Diameter (mm)

- DWC**
- 200
- RCC NP3**
- 300
- 350
- 400
- 500
- 600, 700
- 800

Outfall Summary

| Label | Elevation (Ground) (m) | Elevation (Invert) (m) |
|----------|------------------------|------------------------|
| O-1 | 454.81 | 448.5 |
| O-2 | 455.9 | 454.5 |
| O-3 | 460 | 457 |
| O-4 | 453.36 | 448.3 |
| O-5 | 458.55 | 452 |
| O-MGMIII | 457 | 451.5 |

Manhole Summary

| Sewer District | Diameter (mm) | | Grand Total |
|--------------------|---------------|------------|-------------|
| | 1200 | 1500 | |
| 1 | 789 | 142 | 931 |
| 2 | 595 | 193 | 788 |
| 3 | 232 | 59 | 291 |
| 4 | 424 | 22 | 446 |
| 5 | 328 | 201 | 529 |
| 6 | 607 | 63 | 670 |
| 7 | 331 | 14 | 345 |
| 8 | 417 | 19 | 436 |
| 9 | 222 | 6 | 228 |
| 10 | 252 | 20 | 272 |
| 11 | 422 | 50 | 472 |
| Grand Total | 4619 | 789 | 5408 |

Pipe Summary (without SMC trunk mains)

| District | DWC | | RCC | | | | | | | | Total | Grand Total |
|--------------------|---------------|---------------|-------------|------------|----------|-----------|----------|-----------|-----------|-------------|---------------|-------------|
| | 200 | Total | 200 | 300 | 400 | 500 | 600 | 700 | 800 | | | |
| 1 | 19336 | 19336 | | | | | | | | | 79 | 57 |
| 2 | 18288 | 18288 | 213 | 57 | | | | | | | 20 | 68 |
| 3 | 6338 | 6338 | | 61 | 7 | | | | | | | 22 |
| 4 | 8755 | 8755 | | 22 | | | | | | | | 792 |
| 5 | 10069 | 10069 | 1298 | 792 | | | | | | | | 11 |
| 6 | 13116 | 13116 | | 11 | | | | | | | | |
| 7 | 6603 | 6603 | | | | | | | | | | |
| 8 | 6988 | 6988 | | | | | | | | | | |
| 9 | 4614 | 4614 | | | | | | | | | | |
| 10 | 4899 | 4899 | | | | | | | | | | |
| 11 | 9931 | 9931 | | | | | | | | | | |
| Grand Total | 108937 | 108937 | 1511 | 959 | 7 | 14 | 8 | 22 | 20 | 1028 | 111467 | |

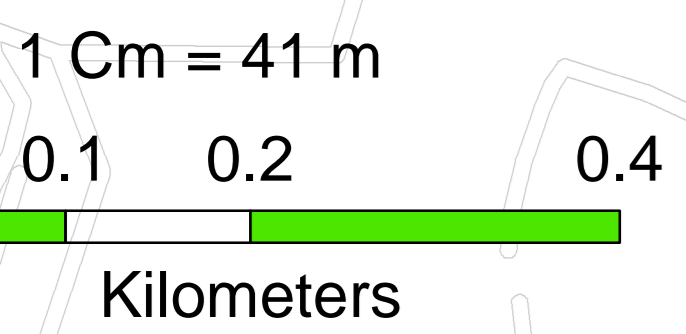

| | | | | | |
|------------|---|-------------|--------------|---------|--------|
| Rev. | Date | Description | Drawn | CHK. | App. |
| File Name: | Wadia Techno Engg. Services Ltd. Mumbai | | Louis Berger | | |
| Client: | SOLAPUR CITY DEVELOPMENT CORPORATION LTD. | | | | |
| Project: | Solapur ABD Area Sewerage System | | | | |
| Title: | All 3 Zones and 11 Sewer Districts | | | | |
| Scale: | A1 | WTE-2297 | 0 | W | R0 1 1 |
| Scale: | Job No. | Code | Discipline | Dwg No. | Rev. |

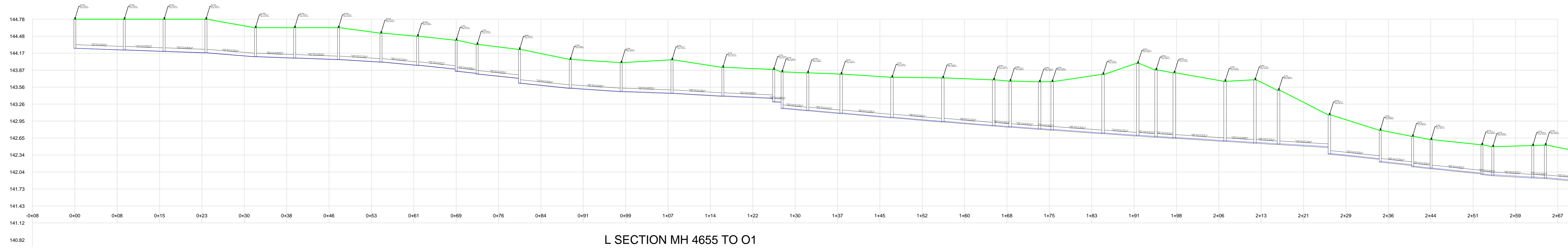
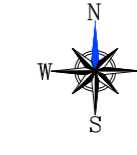

L SECTION MH 4655 TO O1

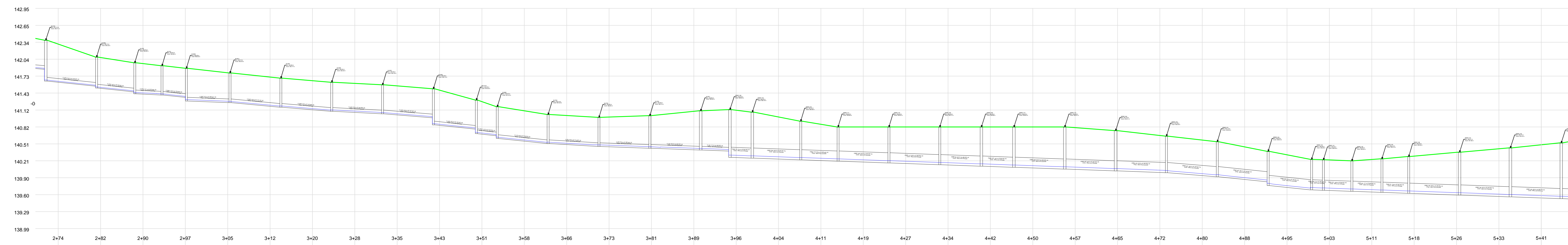

L SECTION MH 4655 TO O1

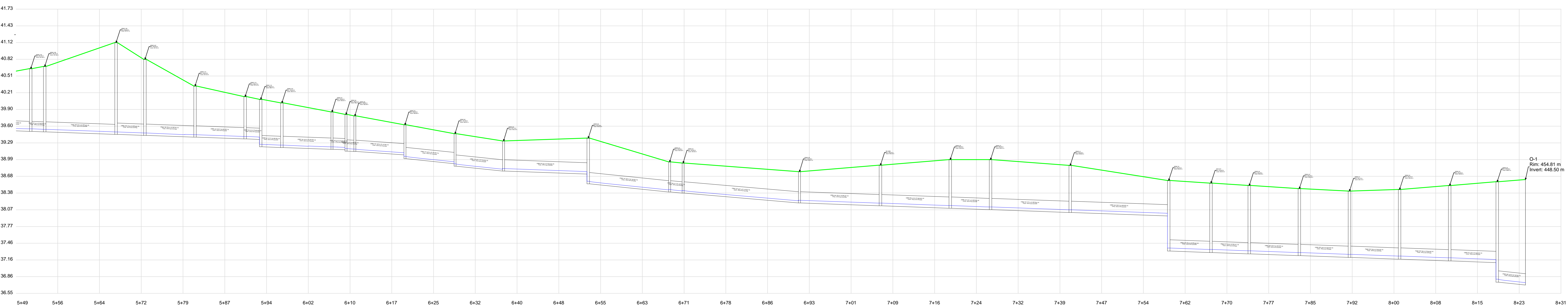

L SECTION MH 4655 TO O1

KEY PLAN

NOTES :-

REFERENCE DRG. NO.

LEGEND :-

- Ground Level
- Pipe
- MH Manhole
- GL Ground Level
- O Outfall

MATCH LINE 1-1

MATCH LINE 2-2

MATCH LINE 2-2

| | | | | | |
|------|----------|-------------|-------|------|------|
| 4 | | | | | |
| 3 | | | | | |
| 2 | | | | | |
| 1 | | | | | |
| 0 | 27.07.18 | FOR TENDER | BR | GN | MS |
| Rev. | Date | Description | Drawn | Chk. | App. |

File name :- MH 1655 TO O1.dwg

| | |
|--|---------------------------------------|
| | |
| Client: SOLAPUR CITY DEVELOPMENT CORPORATION LTD. | |
| Project: DESIGN, DEVELOP, MANAGE & IMPLEMENT URBAN INFRASTRUCTURE SERVICES PROJECTS UNDER SMART CITY MISSION (SCM) IN SOLAPUR CITY | |
| Title: L - Section of Sewer Improvement for ABD Area. | |
| North of NTS | Scale: A 0 WTE-2297 |
| 00 | W 3.01 R1 1 8 |
| Job no. | Code Discipline Drg no. Rev. Sheet of |

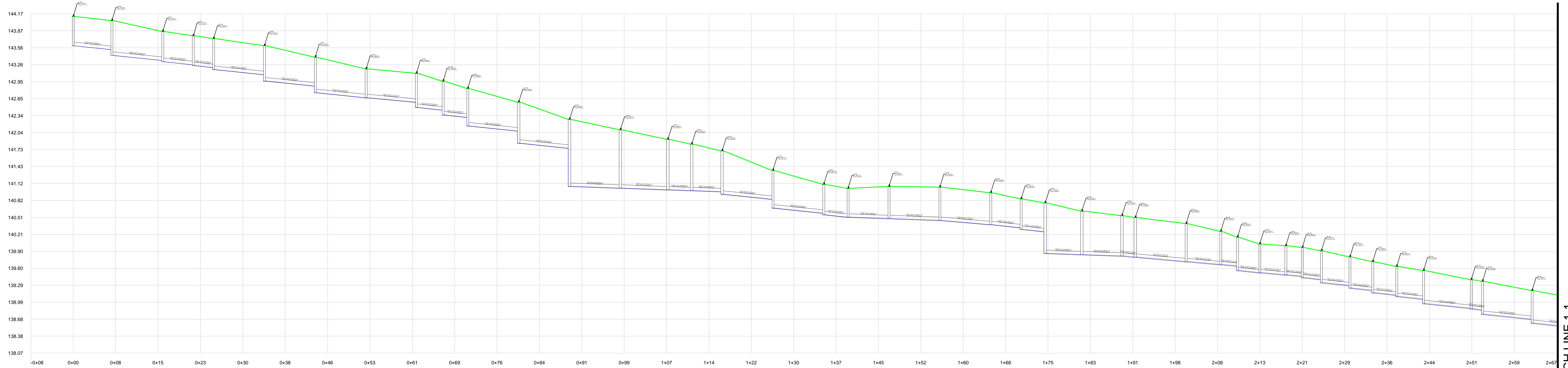

L SECTION MH 4881 TO O1

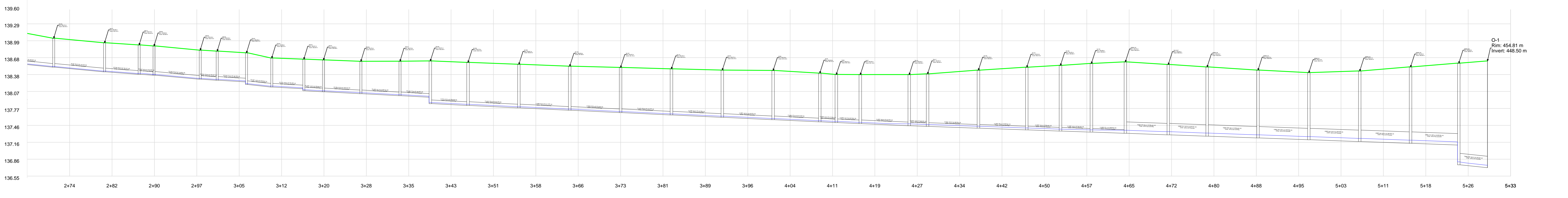

L SECTION MH 4881 TO O1

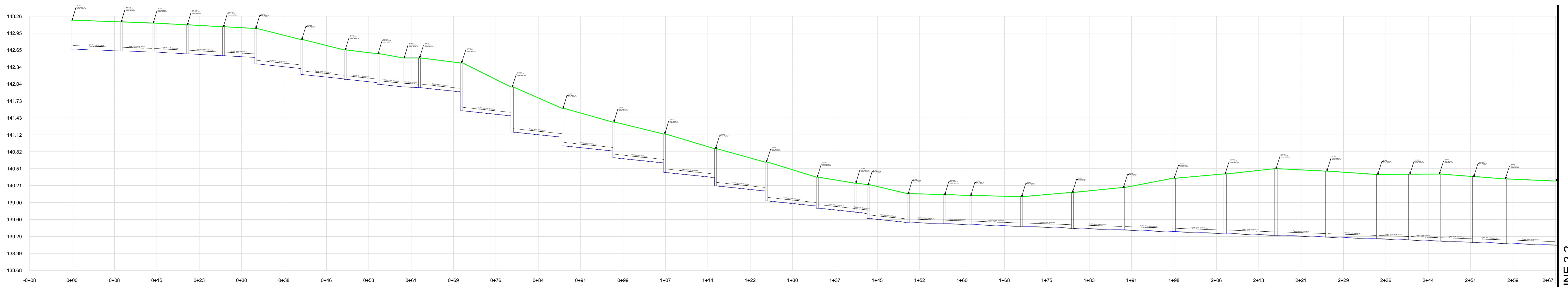

L SECTION MH 5143 TO O2

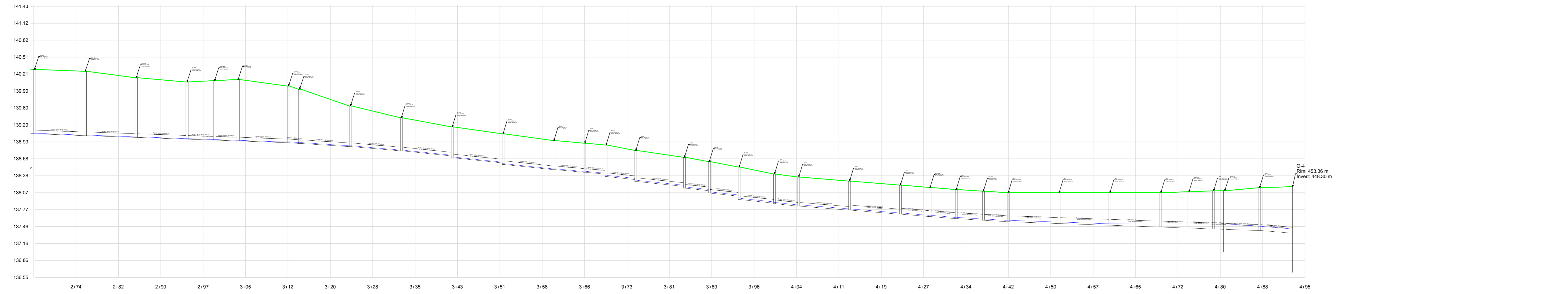

L SECTION MH 5143 TO O2

KEY PLAN

NOTES :-

REFERENCE DRG. NO.

LEGEND :-

- Ground Level
- Pipe
- MH Manhole
- GL Ground Level
- O Outfall

| | | | | | |
|------|----------|-------------|-------|------|------|
| 4 | | | | | |
| 3 | | | | | |
| 2 | | | | | |
| 1 | | | | | |
| 0 | 27.07.18 | FOR TENDER | BR | GN | MS |
| Rev. | Date | Description | Drawn | Chk. | App. |

Client: SOLAPUR CITY DEVELOPMENT CORPORATION LTD.
 Project: DESIGN, DEVELOP, MANAGE & IMPLEMENT URBAN INFRASTRUCTURE SERVICES PROJECTS UNDER SMART CITY MISSION (SCM) IN SOLAPUR CITY
 Title: L - Section of Sewer Improvement for ABD Area.

| | | | | | | | | |
|-------|-----|-----------------|------|------------|---------|------|-------|----|
| North | A 0 | WTE-2297 | 00 | W | 3.01 | R1 | 2 | 8 |
| Scale | NTS | Job no. | Code | Discipline | Dig.No. | Rev. | Sheet | Of |

MATCH LINE 1-1

MATCH LINE 1-1

MATCH LINE 2-2

MATCH LINE 2-2

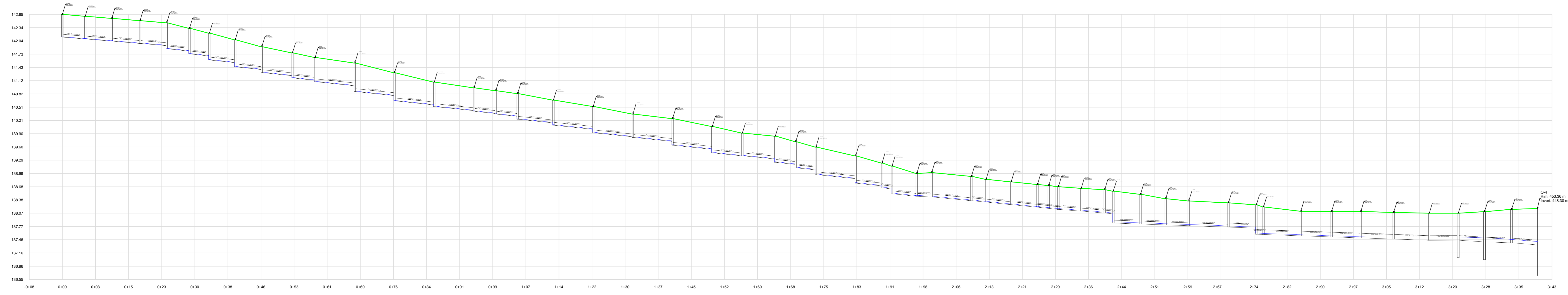

L SECTION MH 4763 TO O2

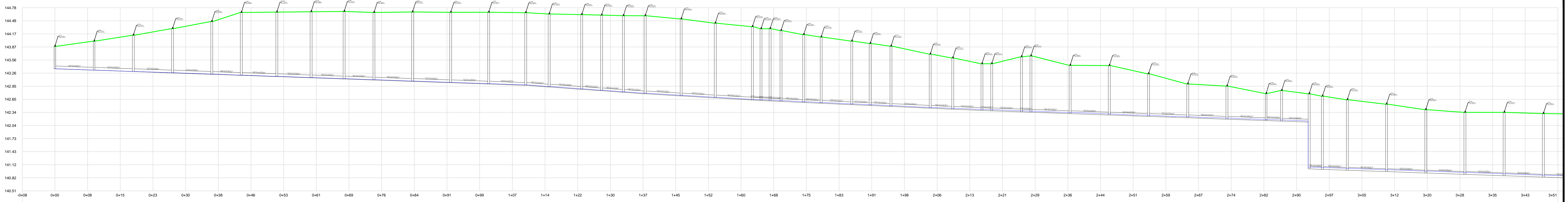

L SECTION MH 4771 TO O2

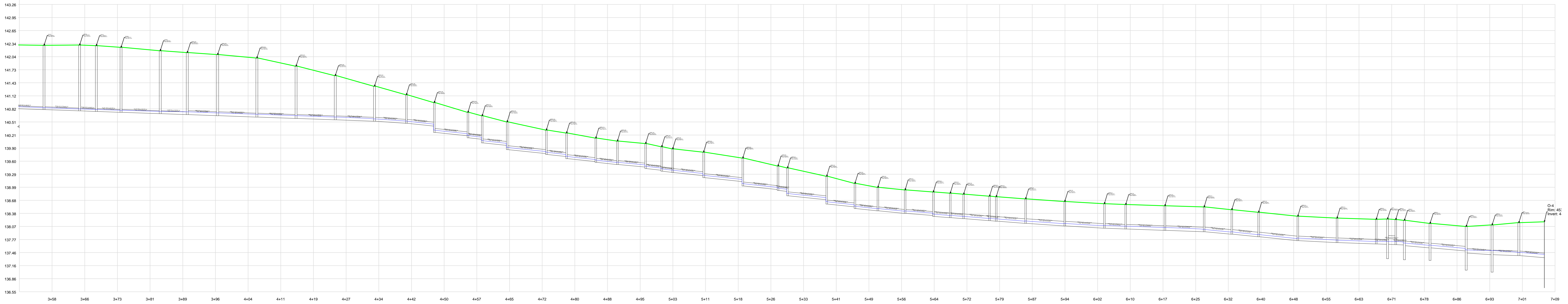

L SECTION MH 4771 TO O2

KEY PLAN

NOTES :-

REFERENCE DRG. NO.

LEGEND :-

- Ground Level
- Pipe
- MH Manhole
- GL Ground Level
- O Outfall

| | | | | |
|------|----------|-------------|-------|-----------|
| 4 | | | | |
| 3 | | | | |
| 2 | | | | |
| 1 | | | | |
| 0 | 27.07.18 | FOR TENDER | BR | GNG MS |
| Rev. | Date | Description | Drawn | Chk. App. |

Client: SOLAPUR CITY DEVELOPMENT CORPORATION LTD.
 Project: DESIGN, DEVELOP, MANAGE & IMPLEMENT URBAN INFRASTRUCTURE SERVICES PROJECTS UNDER SMART CITY MISSION (SCM) IN SOLAPUR CITY
 Title: L - Section of Sewer Improvement for ABD Area.

| | | | | | | | | |
|----------|-----|-----------------|------|------------|---------|------|-------|----|
| North of | A 0 | WTE-2297 | 00 | W | 3.01 | R1 | 3 | 8 |
| Scale | NTS | Job no. | Code | Discipline | Dig.No. | Rev. | Sheet | Of |

MATCH LINE 1-1

MATCH LINE 1-1

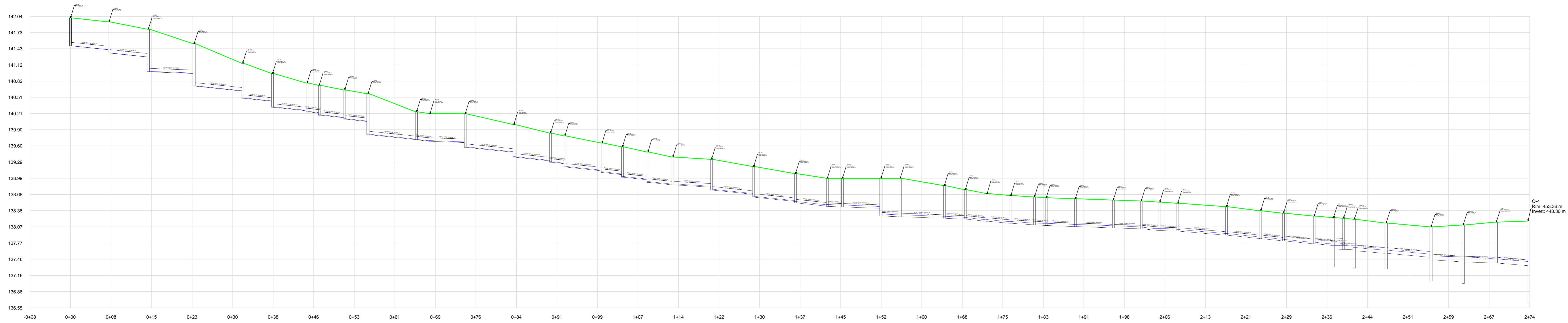

L SECTION MH 589 TO O2

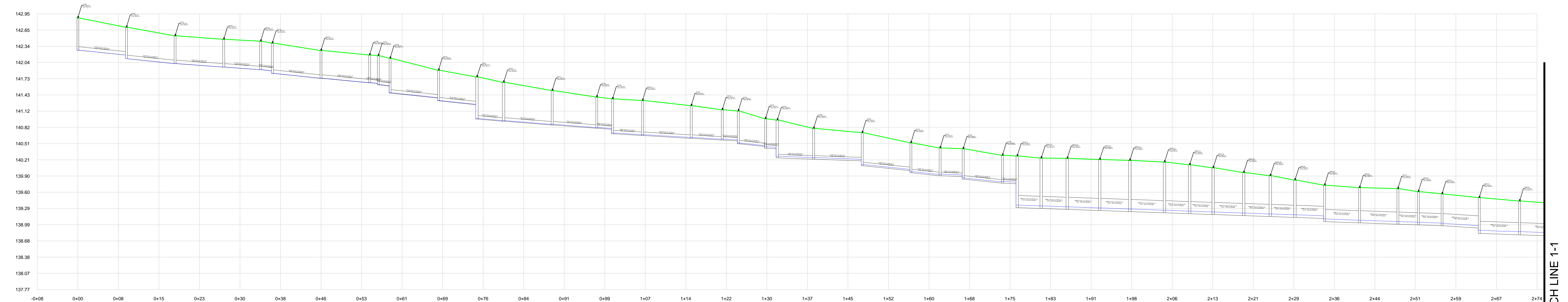

L SECTION MH 4386 TO O5

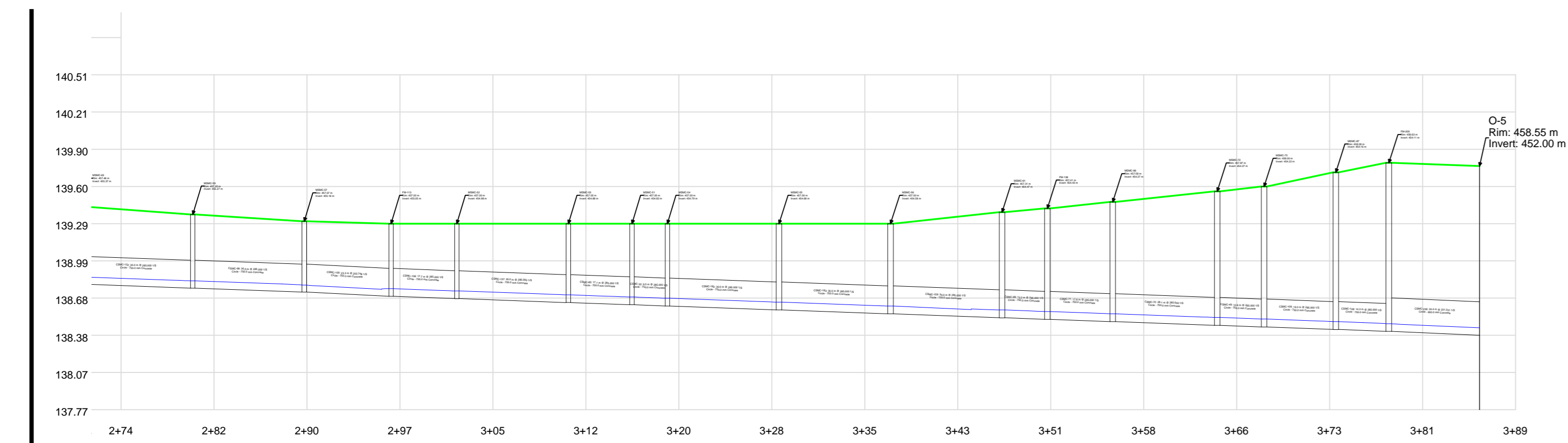

L SECTION MH 4386 TO O5

MATCH LINE 1-1

KEY PLAN

NOTES :-

REFERENCE DRG. NO.

LEGEND :-

- Ground Level
- Pipe
- MH Manhole
- GL Ground Level
- O Outfall

| | | | | |
|------|----------|-------------|-------|-----------|
| 4 | | | | |
| 3 | | | | |
| 2 | | | | |
| 1 | | | | |
| 0 | 27.07.18 | FOR TENDER | BR | GNG MS |
| Rev. | Date | Description | Drawn | Chk. App. |

File name: MH 4881 TO O1.dwg

Wadia Techno Engg. Services Ltd. Mumbai **Louis Berger**

Client: SOLAPUR CITY DEVELOPMENT CORPORATION LTD.

Project: DESIGN, DEVELOP, MANAGE & IMPLEMENT URBAN INFRASTRUCTURE SERVICES PROJECTS UNDER SMART CITY MISSION (SCM) IN SOLAPUR CITY

Title: L - Section of Sewer Improvement for ABD Area.

North of A 0 NTS **WTE-2297** 00 W 3.01 R1 4 8

Scale Job no. Code Discipline Dign. Rev. Sheet of

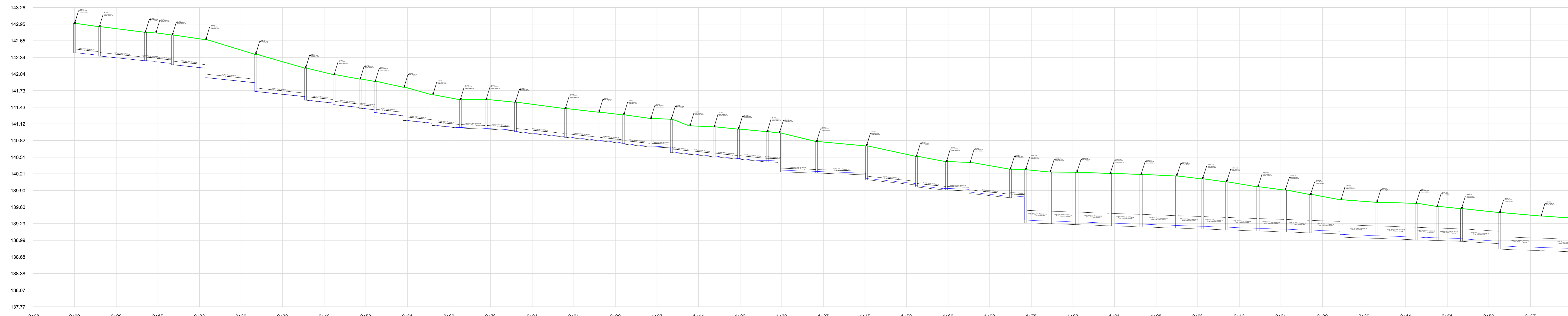

L SECTION MH 4417 TO O5

MATCH LINE 1-1

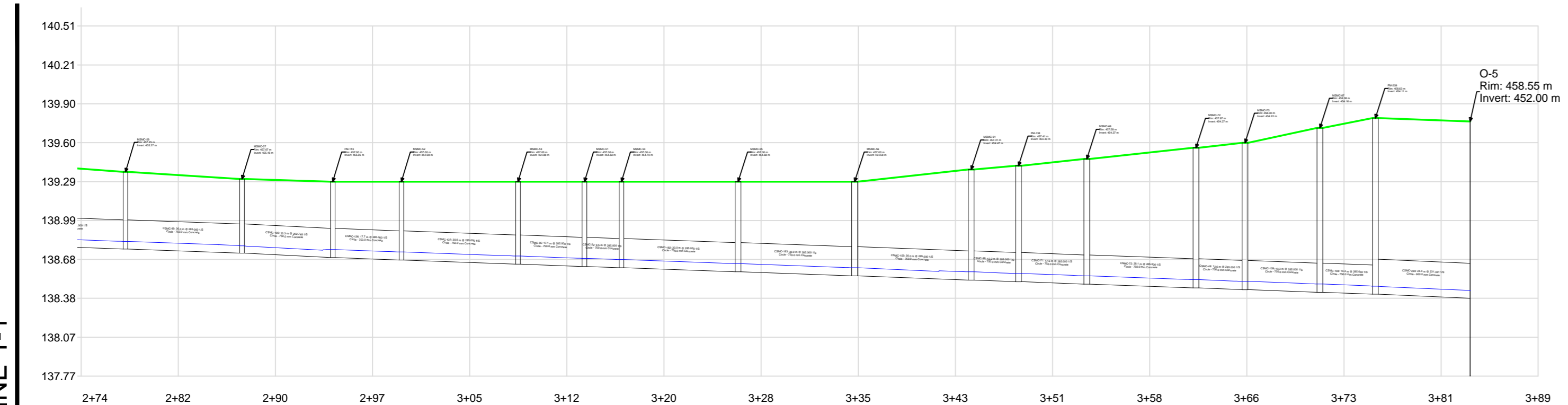

L SECTION MH 4417 TO O5

MATCH LINE 1-1

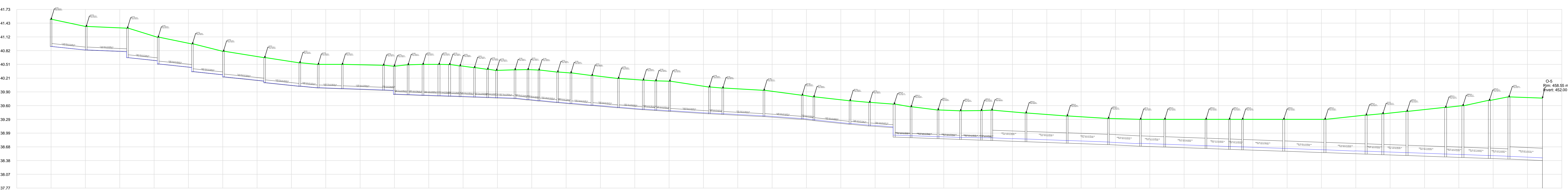

L SECTION MH 3300 TO O5

KEY PLAN

NOTES :-

REFERENCE DRG. NO.

LEGEND :-

- Ground Level
- Pipe
- MH Manhole
- GL Ground Level
- O Outfall

| | | | | |
|------|----------|-------------|-------|-----------|
| 4 | | | | |
| 3 | | | | |
| 2 | | | | |
| 1 | | | | |
| 0 | 27.07.18 | FOR TENDER | BR | GNG MS |
| Rev. | Date | Description | Drawn | Chk. App. |

Wadia Techno Engg. Services Ltd. Mumbai

Louis Berger

Client: SOLAPUR CITY DEVELOPMENT CORPORATION LTD.

Project: DESIGN, DEVELOP, MANAGE & IMPLEMENT URBAN INFRASTRUCTURE SERVICES PROJECTS UNDER SMART CITY MISSION (SCM) IN SOLAPUR CITY

Title: L - Section of Sewer Improvement for ABD Area.

North of NTS

| | | | | | | | | |
|-------|-----|----------|------|------------|--------|------|-------|----|
| Scale | A 0 | WTE-2297 | 00 | W | 3.01 | R1 | 5 | 8 |
| | | Job no. | Code | Discipline | Dg.no. | Rev. | Sheet | Of |

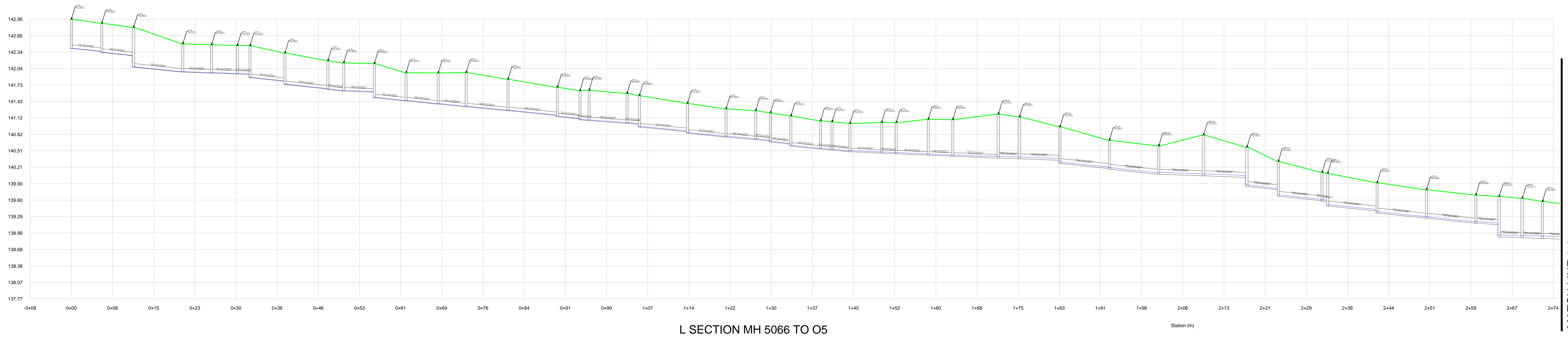

L SECTION MH 5066 TO O5

MATCH LINE 1-1

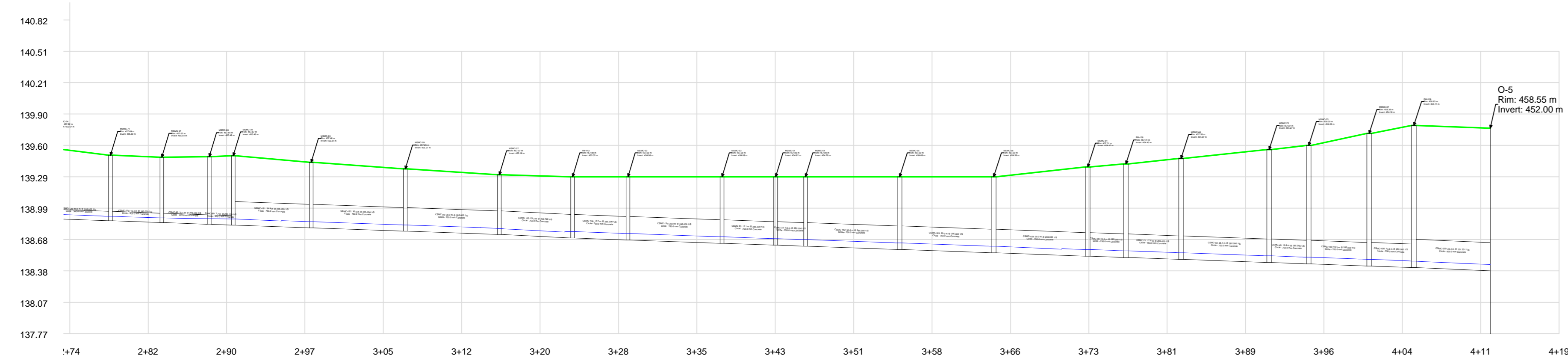

L SECTION MH 5066 TO O5

MATCH LINE 1-1

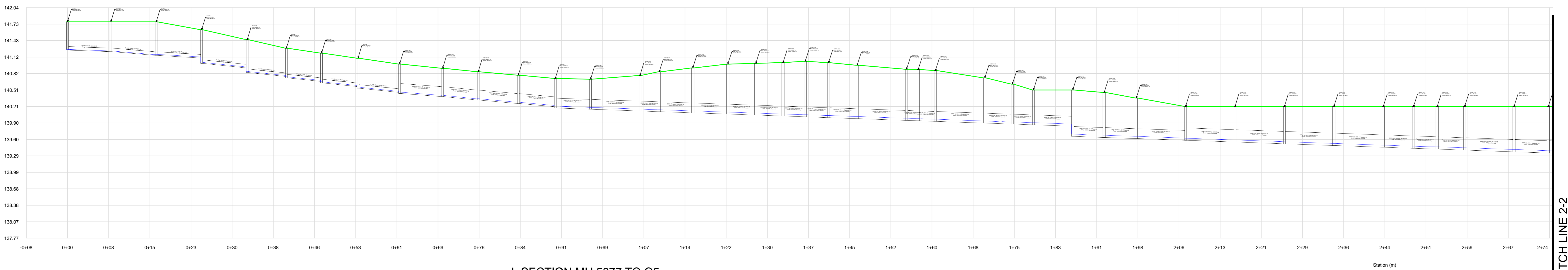

L SECTION MH 5077 TO O5

MATCH LINE 2-2

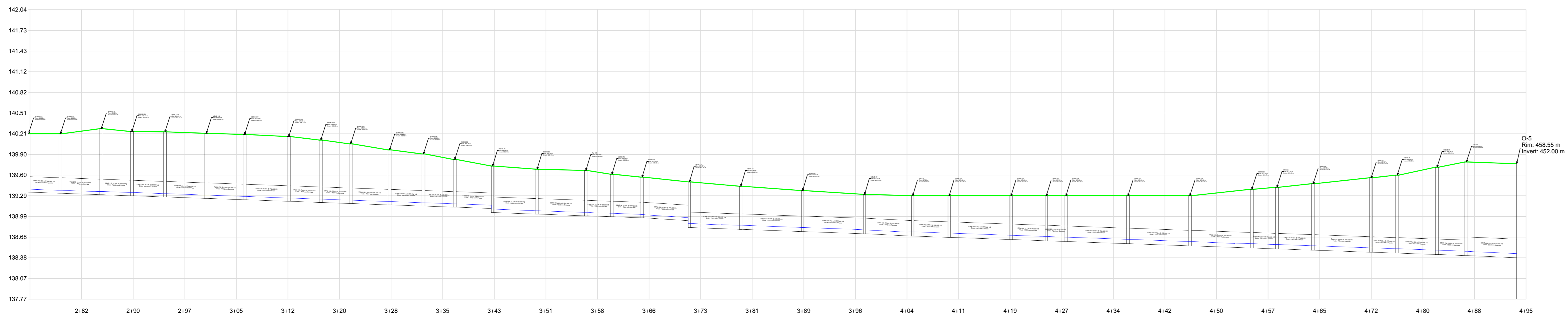

L SECTION MH 5077 TO O5

MATCH LINE 2-2

KEY PLAN

NOTES :-

REFERENCE DRG. NO.

LEGEND :-

- Ground Level
- Pipe
- MH Manhole
- GL Ground Level
- O Outfall

| | | | | | |
|------|----------|-------------|-------|--------|------|
| 4 | | | | | |
| 3 | | | | | |
| 2 | | | | | |
| 1 | | | | | |
| 0 | 27.07.18 | FOR TENDER | BR | GNG MS | |
| Rev. | Date | Description | Drawn | Chk. | App. |

Client: SOLAPUR CITY DEVELOPMENT CORPORATION LTD.
 Project: DESIGN, DEVELOP, MANAGE & IMPLEMENT URBAN INFRASTRUCTURE SERVICES PROJECTS UNDER SMART CITY MISSION (SCM) IN SOLAPUR CITY
 Title: L - Section of Sewer Improvement for ABD Area.

| | | | | | | | | |
|-------|-----|-----------------|------|------------|-------|------|-------|----|
| North | A 0 | WTE-2297 | 00 | W | 3.01 | R1 | 6 | 8 |
| Scale | NTS | Job no. | Code | Discipline | Dign. | Rev. | Sheet | Of |

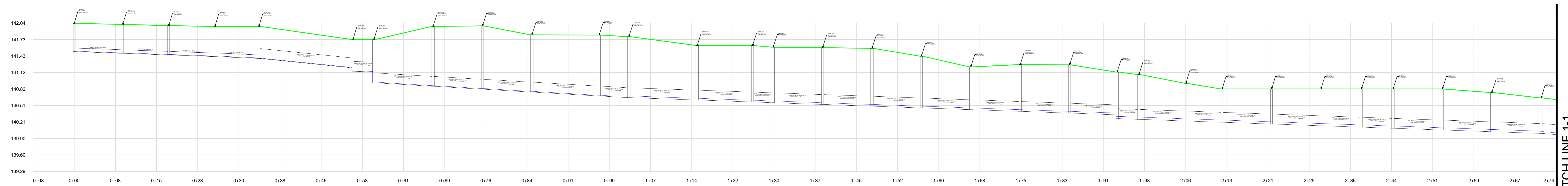

L SECTION MH 4860 TO O1

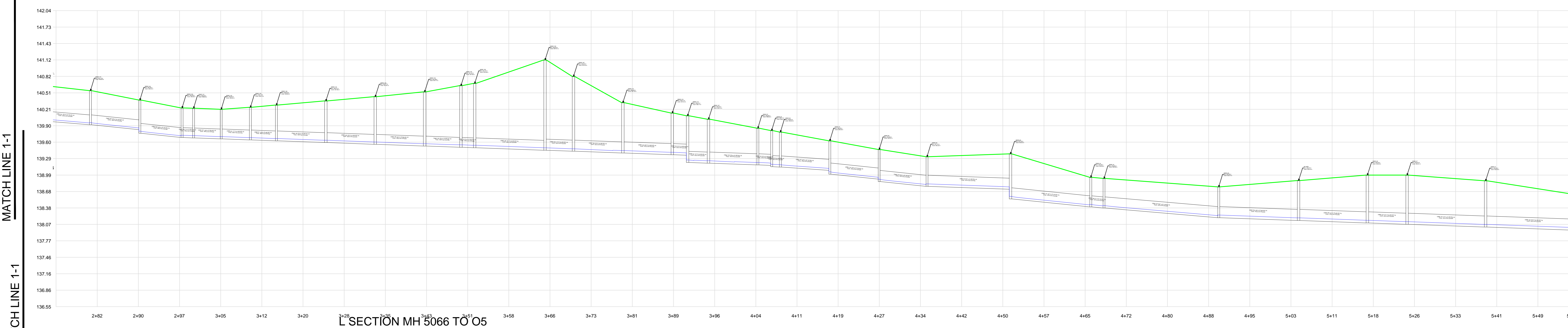

L SECTION MH 5066 TO O5

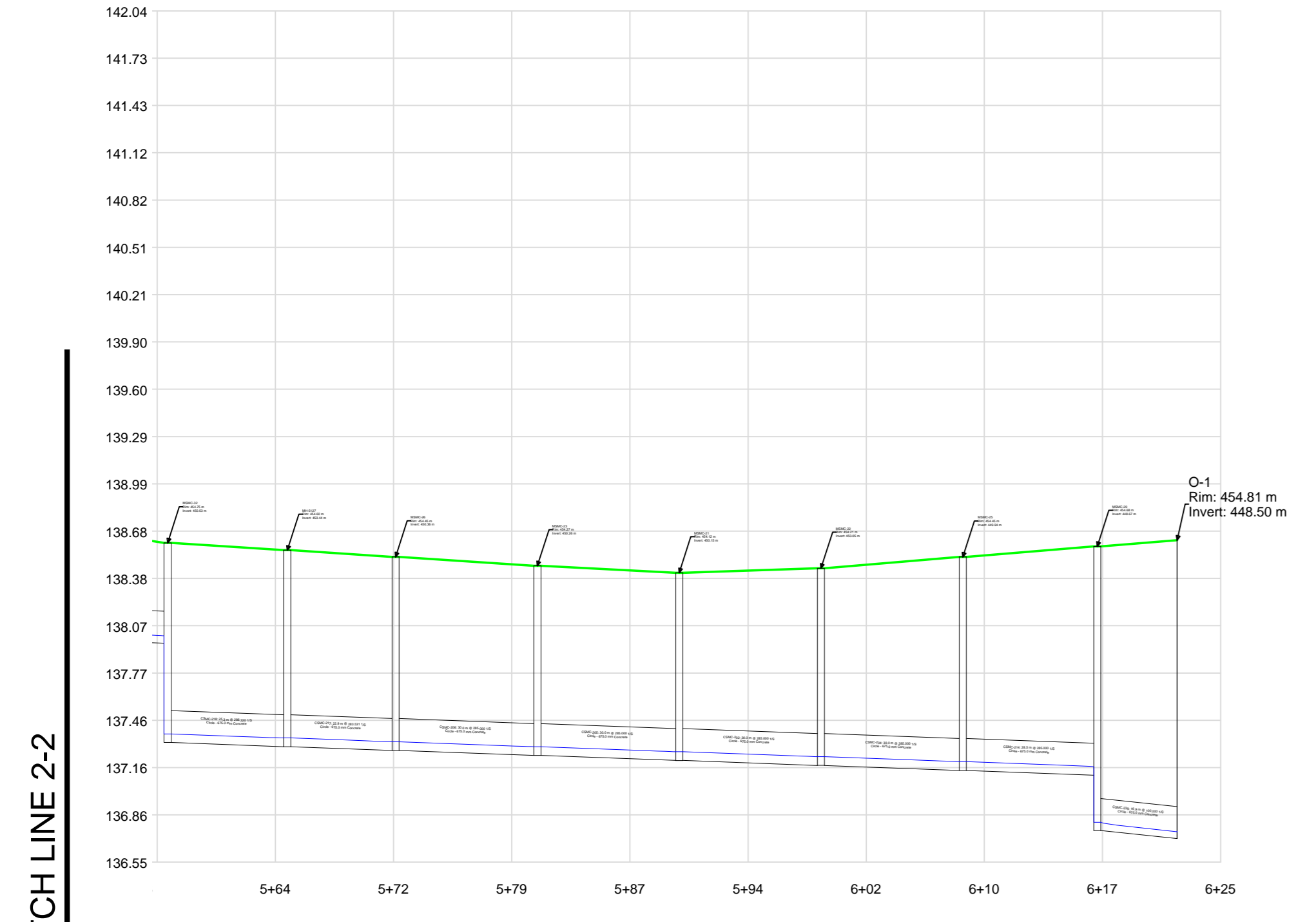

L SECTION MH 4860 TO O1

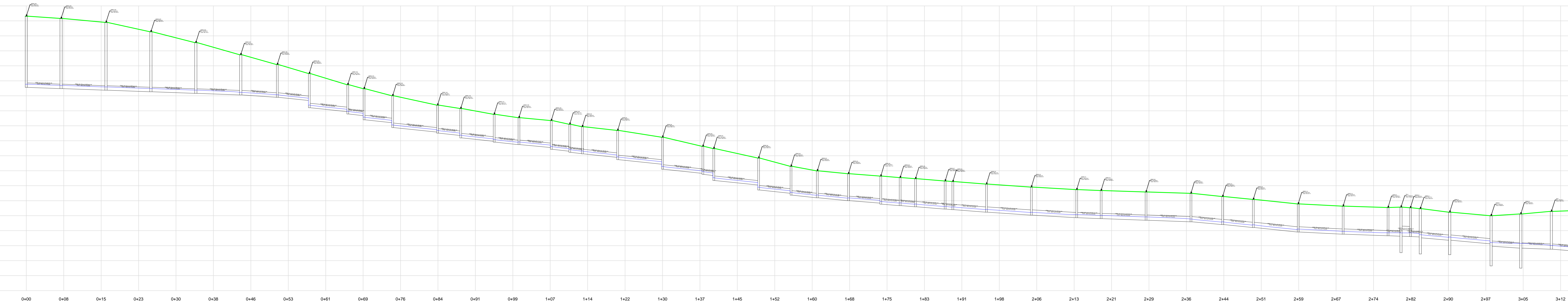

L SECTION MH 234 TO O4

KEY PLAN



NOTES :-

REFERENCE DRG. NO.

LEGEND :-

- Ground Level
- Pipe
- MH Manhole
- GL Ground Level
- O Outfall

| | | | | |
|------|----------|-------------|-------|-----------|
| 4 | | | | |
| 3 | | | | |
| 2 | | | | |
| 1 | | | | |
| 0 | 27.07.18 | FOR TENDER | BR | GNG MS |
| Rev. | Date | Description | Drawn | Chk. App. |



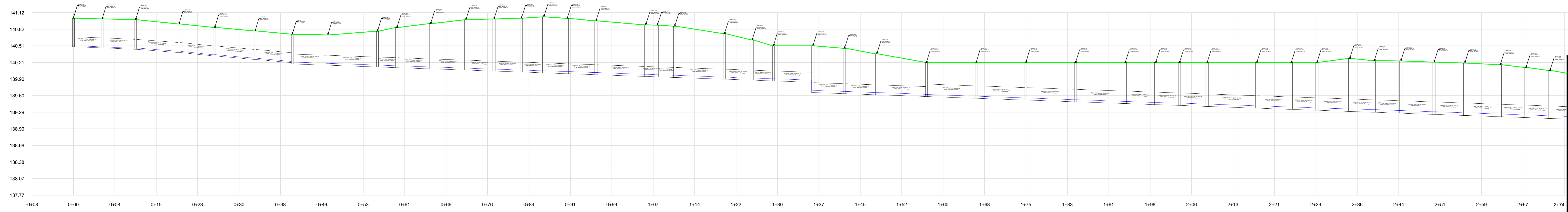

Client: SOLAPUR CITY DEVELOPMENT CORPORATION LTD.
 Project: DESIGN, DEVELOP, MANAGE & IMPLEMENT URBAN INFRASTRUCTURE SERVICES PROJECTS UNDER SMART CITY MISSION (SCM) IN SOLAPUR CITY
 Title: L - Section of Sewer Improvement for ABD Area.

| | | | | | | | | |
|-------|-----|----------|------|------------|--------|------|-------|----|
| North | A 0 | WTE-2297 | 00 | W | 3.01 | R1 | 7 | 8 |
| | NTS | Job no. | Code | Discipline | Digno. | Rev. | Sheet | Of |

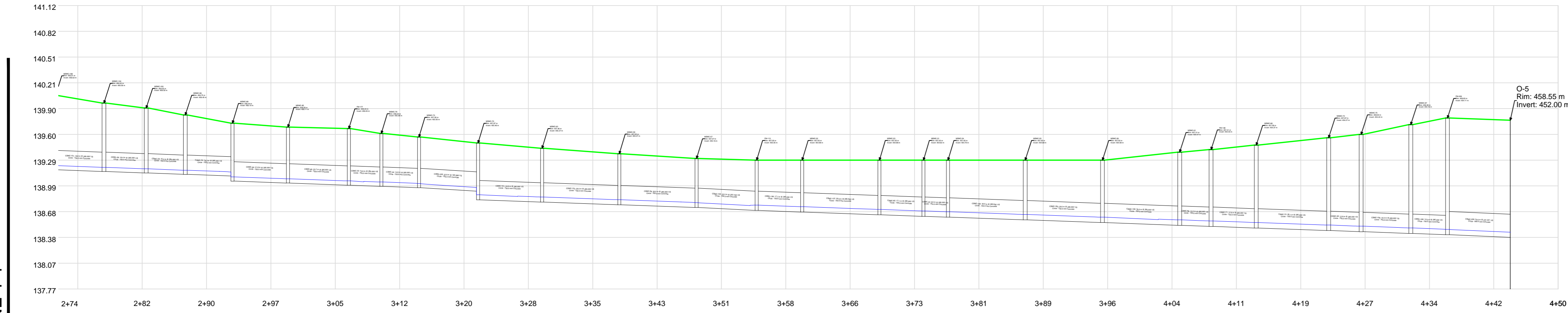

L SECTION MH 189 TO O5



L SECTION MH 189 TO O5

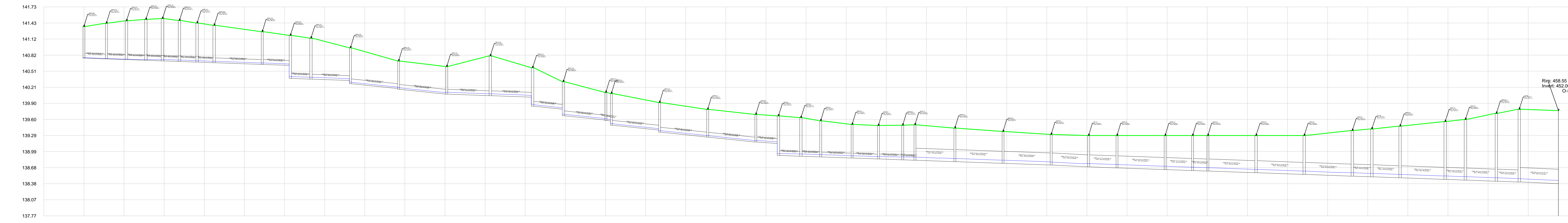

L SECTION MH 208 TO O5

KEY PLAN

NOTES :-

REFERENCE DRG. NO.

LEGEND :-

- Ground Level
- Pipe
- MH Manhole
- GL Ground Level
- O Outfall

| | | | | |
|------|----------|-------------|-------|-----------|
| 4 | | | | |
| 3 | | | | |
| 2 | | | | |
| 1 | | | | |
| 0 | 27.07.18 | FOR TENDER | BR | GNG MS |
| Rev. | Date | Description | Drawn | Chk. App. |

Client: SOLAPUR CITY DEVELOPMENT CORPORATION LTD.
 Project: DESIGN, DEVELOP, MANAGE & IMPLEMENT URBAN INFRASTRUCTURE SERVICES PROJECTS UNDER SMART CITY MISSION (SCM) IN SOLAPUR CITY
 Title: L - Section of Sewer Improvement for ABD Area.

| | | | | | | | | |
|----------|-----|-----------------|------|------------|---------|------|-------|----|
| North of | A 0 | WTE-2297 | 00 | W | 3.01 | R1 | 8 | 8 |
| Scale | NTS | Job no. | Code | Discipline | Dig.No. | Rev. | Sheet | Of |

PRESSURE TRANSMITTER

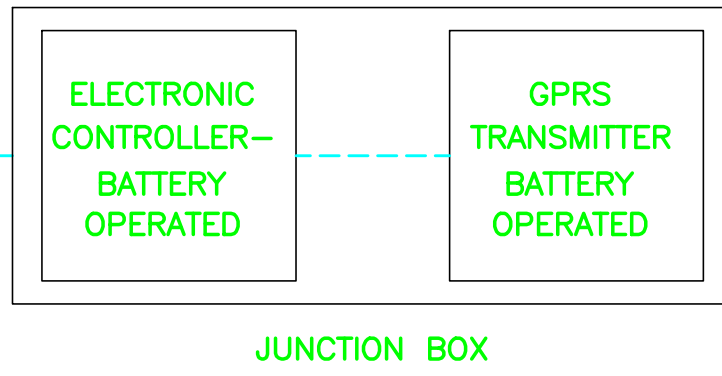
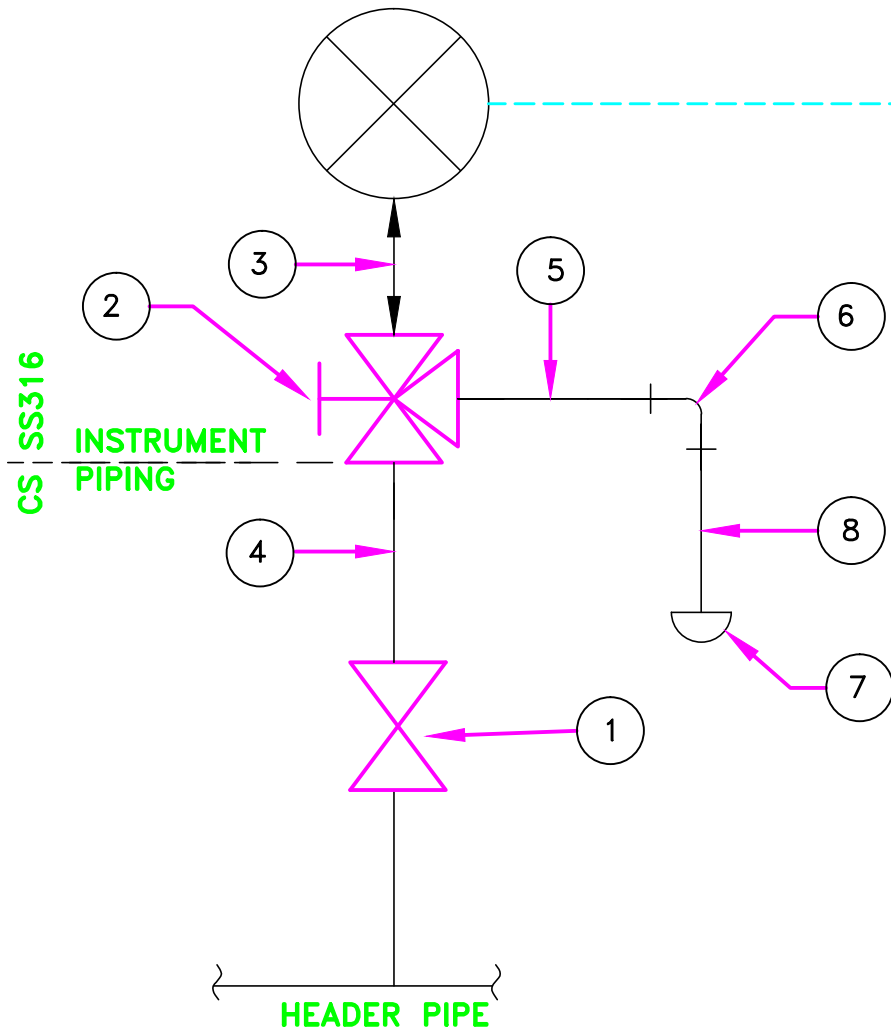

NOTES :-
 01) THE LIST OF ITEMS LISTED HEREWITH FOR INFORMATION ONLY.
 02) THE ARRANGEMENT MAY CHANGE SUBJECT TO VENDOR.

LEGEND :-

LIST OF ITEMS

| ITEM. NO. | DESCRIPTION | SIZE | MOC | QTY. PER TAG |
|-----------|--------------------|--|-------|--------------|
| 1 | GATE VALVE | 15 NB, SW | CS | 01 NOS. |
| 2 | 2 WAY VALVE | 1/2" NPT (F) & DRAIN 1/4" NPT (F) | SS | 01 NOS. |
| 3 | NIPPLE 150 MM LONG | BOTH SIDE SIDE 1/2" NPT (M) | SS316 | 01 NO. |
| 4 | NIPPLE 150 MM LONG | ONE SIDE 15 NB PLANE END & OTHER SIDE 1/2" NPT (M) | CS | 01 NO. |
| 5 | SWAGE NIPPLE | 1/2", PLAIN END x 1/4" NPT(M) | SS316 | 01 NO. |
| 6 | 90° ELBOW | 1/2", SW | SS316 | 01 NO. |
| 7 | END CAP | 1/2" NPT (F) | SS316 | 01 NO. |
| 8 | NIPPLE 150 MM LONG | ONE SIDE 15 NB PLANE END & OTHER SIDE 1/2" NPT (M) | SS316 | 01 NO. |

INSTRUMENT PROCESS CONNECTION:- 1/2" NPT (F)

TYPICAL ARRANGEMENT DRAWING FOR PRESSURE TRANSMITTER (LOGGERS)

WTE DRAWING FOR COMMENTS / APPROVAL
 SIGNATURE _____ DATE _____

| | | | | |
|------|----------|-------------|-------|--------|
| 4 | | | | |
| 3 | | | | |
| 2 | | | | |
| 1 | | | | |
| 0 | 06.08.16 | FOR TENDER | BR | GNG MS |
| Rev. | Date | Description | Drawn | Chk. |

WTE Wadia Techno Engg. Services Ltd. Mumbai Louis Berger

Client: SOLAPUR CITY DEVELOPMENT CORPORATION LTD.
 Project: DESIGN, DEVELOP, MANAGE & IMPLEMENT URBAN INFRASTRUCTURE SERVICES PROJECTS UNDER SMART CITY MISSION (SCM) IN SOLAPUR CITY

Title: TYPICAL ARRANGEMENT DRAWING FOR PRESSURE LOGGERS.

North: A 0 NTS WTE-2297 00 W 2.26 R0 1 1
 Scale Job no. Code Discipline Dwg.no. Rev. Sheet

- NOTES :-**
1. ALL STRUCTURAL DIMENSION ARE IN MILLIMETER UNLESS OTHERWISE SPECIFIED.
 2. THE WALL THICKNESS SHOULD CHECK WITH STRUCTURAL DESIGN BEFORE EXECUTION.
 3. THE ARRANGEMENT OF AIR VALVE MAY BE CHANGE SUBJECT TO VENDOR.

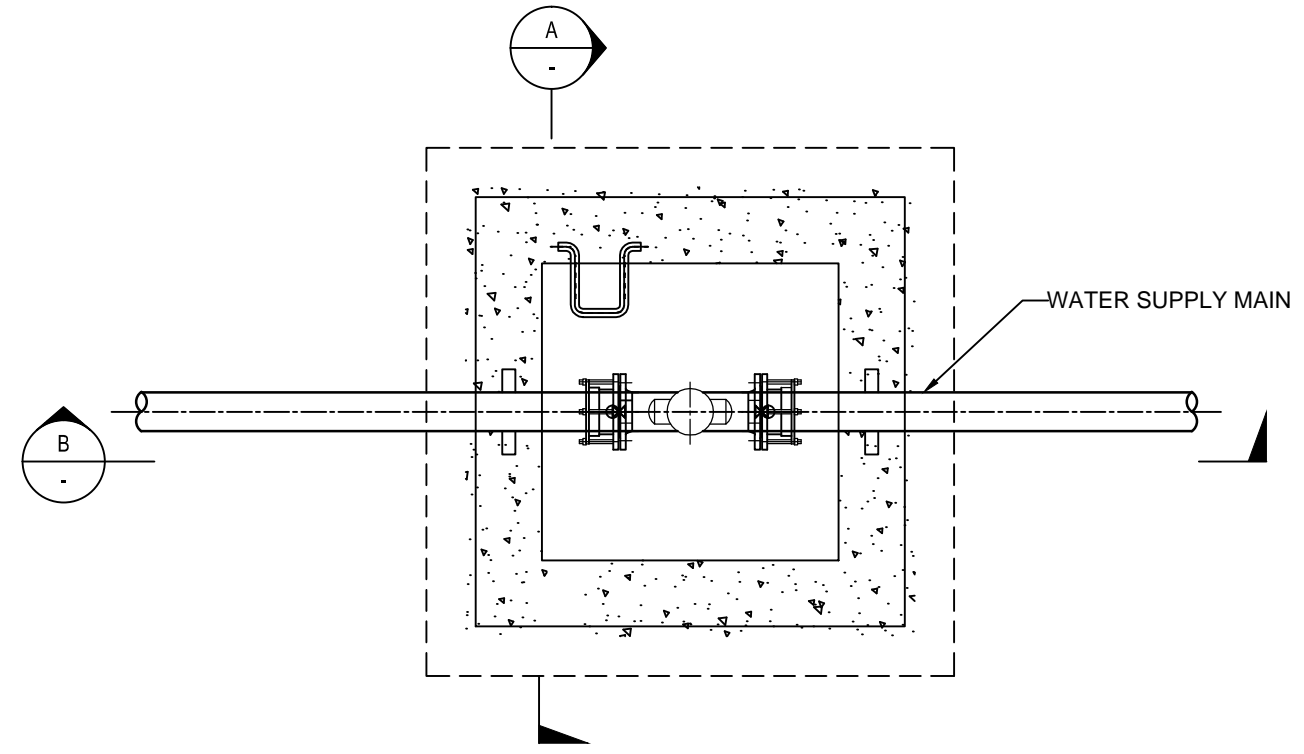

PLAN
SCALE 1:20

- LEGEND :-**
1. THK = THICKNESS
 2. G.L = GROUND LEVEL

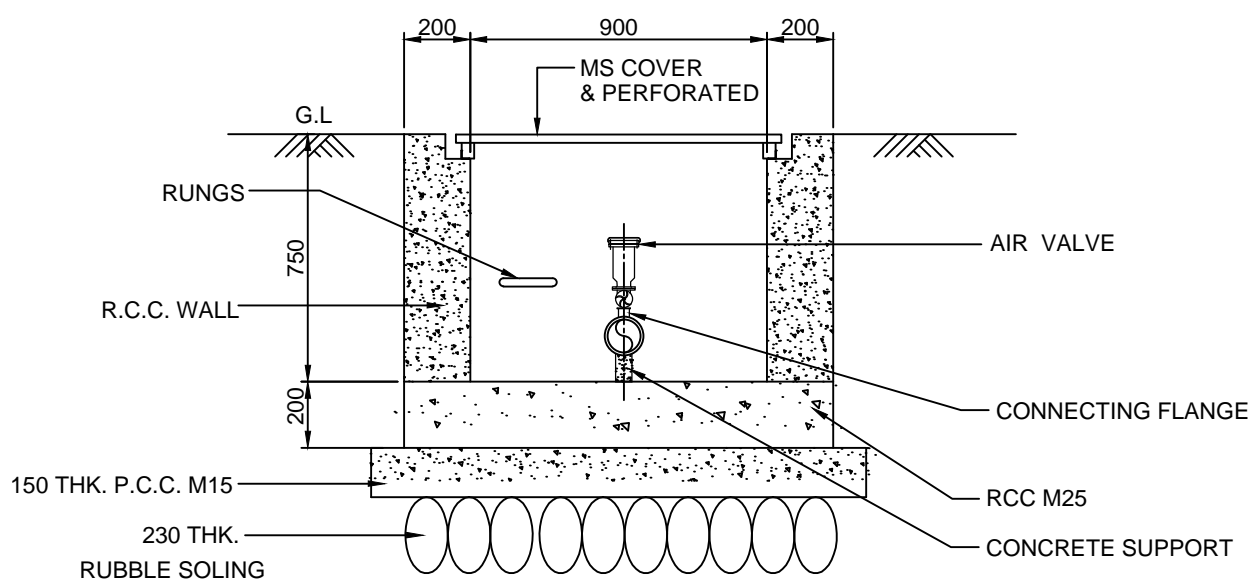

SECTION A-A
SCALE 1:20

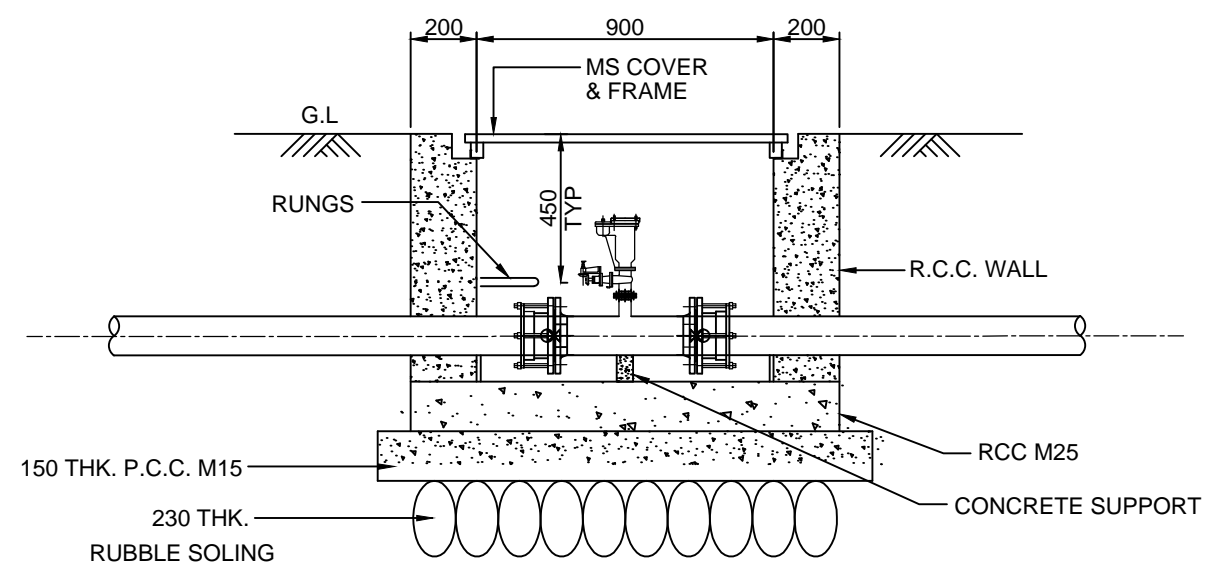

SECTION B-B
SCALE 1:20

TYPICAL DETAILS OF AIR VALVE CHAMBER
SCALE 1:20

WTS DRAWING FOR COMMENTS / APPROVAL
SIGNATURE _____ DATE _____

| | | | | | |
|-----|----------|-------------|-------|-----|-----|
| 4 | | | | | |
| 3 | | | | | |
| 2 | | | | | |
| 1 | | | | | |
| 0 | 06.08.18 | FOR TENDER | BR | GNG | MS |
| Rev | Date | Description | Drawn | Chk | App |

Wadia Techno Engg. Services Ltd. Mumbai

Louis Berger

Client: SOLAPUR CITY DEVELOPMENT CORPORATION LTD.

Project: DESIGN, DEVELOP, MANAGE & IMPLEMENT URBAN INFRASTRUCTURE SERVICES PROJECTS UNDER SMART CITY MISSION (SCM) IN SOLAPUR CITY

Title: TYPICAL DETAIL OF AIR VALVE CHAMBER

| | | | | | | | | |
|-------|---------|----------|------------|-------|------|-------|----|---|
| North | A 0 NTS | WTE-2297 | 00 | W | 2.21 | R0 | 1 | 1 |
| Scale | Job no. | Code | Discipline | Drawn | Rev | Sheet | Of | |

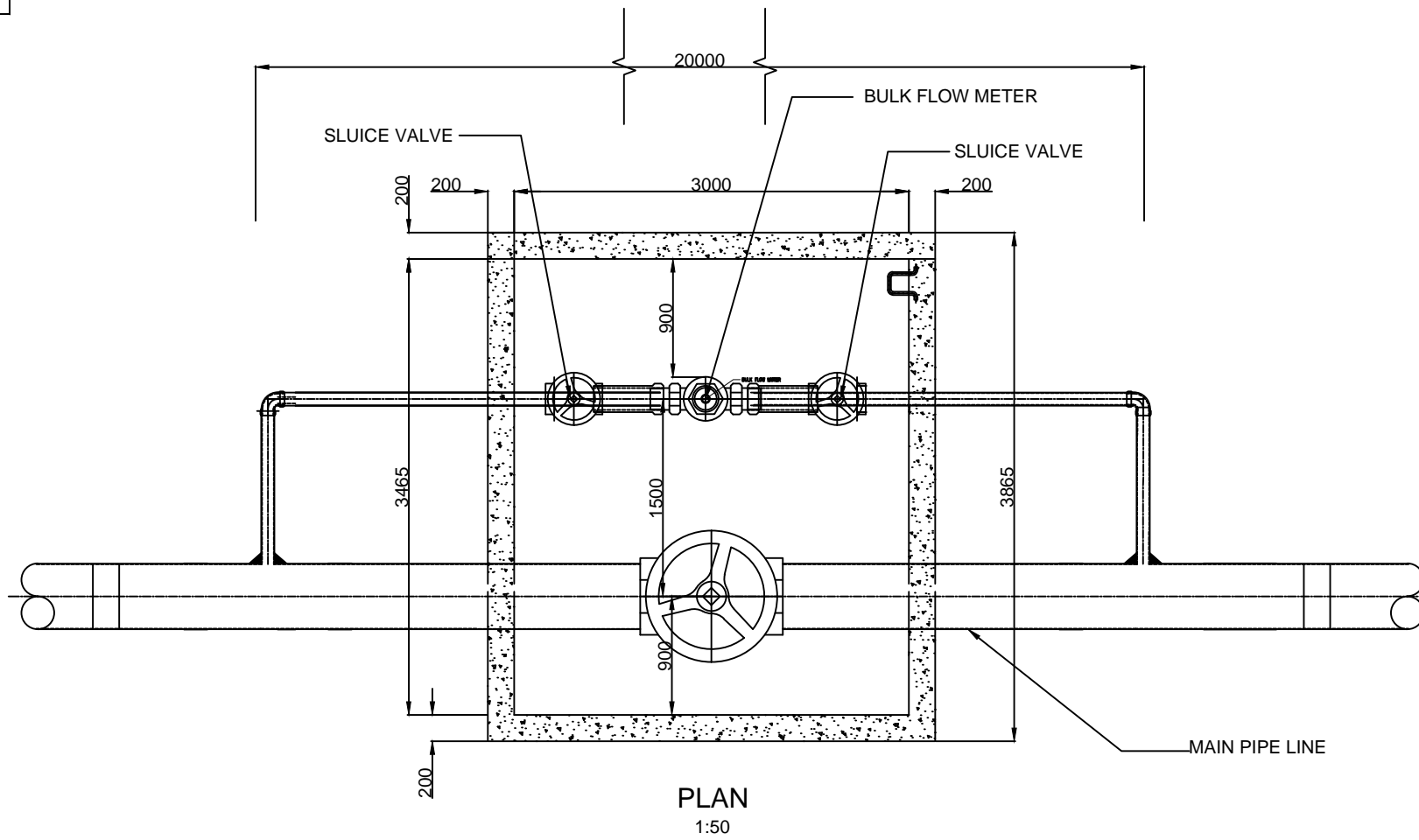

PLAN
1:50

ELECTRO MAGNETIC
BULK FLOW METER

| DETAILS OF PIPE FOR ELECTROMAGNETIC BULK FLOWMETER STATION | | | | |
|--|---------------------------|----------------------------------|--------------------------------------|-----------------------|
| DMA NO. | MATERIAL OF MAIN PIPELINE | DIAMETER OF MAIN PIPE LINE IN mm | DIAMETER OF PIPE FOR FLOWMETER IN mm | FLOW METER SIZE in mm |
| 1 | DI K7 | 600 | 150 | 150 |
| 18 | DI K7 | 350 | 150 | 150 |
| 2 | DI K9 | 500 | 150 | 150 |
| 3 | DI K9 | 300 | 150 | 150 |
| 4 | DI K9 | 400 | 100 | 100 |
| 5 | DI K9 | 400 | 150 | 150 |
| 7 | DI K7 | 350 | 100 | 100 |
| 7 | DI K9 | 300 | 100 | 100 |
| 8 | DI K7 | 450 | 100 | 100 |
| 10 | DI K9 | 500 | 150 | 150 |
| 11 | DI K9 | 300 | 100 | 100 |
| 12 | DI K7 | 600 | 150 | 150 |
| 24 | DI K9 | 300 | 100 | 100 |
| 21 | DI K9 | 300 | 100 | 100 |
| 13 A | DI K7 | 500 | 100 | 100 |
| 13 B | DI K9 | 300 | 100 | 100 |
| 13 B | DI K9 | 100 | 100 | 100 |
| 16 | CI | 525 | 100 | 100 |
| 20 | DI K7 | 400 | 100 | 100 |
| 20 | DI K9 | 450 | 100 | 100 |
| 17 | DI K7 | 700 | 100 | 100 |
| 19 | CI | 525 | 150 | 150 |
| 23 A | DI K7 | 200 | 100 | 100 |
| 23 B | DI K7 | 700 | 150 | 150 |
| 23 C | DI K7 | 450 | 150 | 150 |
| 23 C | DI K7 | 450 | 150 | 150 |

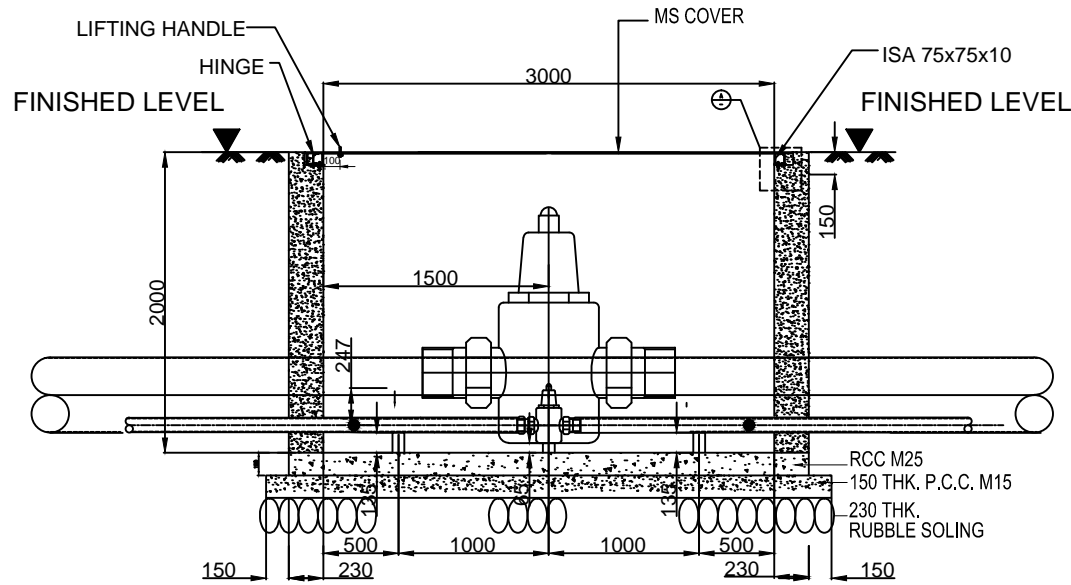

SECTION E-E
1:50

TYPICAL SECTION FOR ELECTRO MAGNETIC
BULK FLOW METER

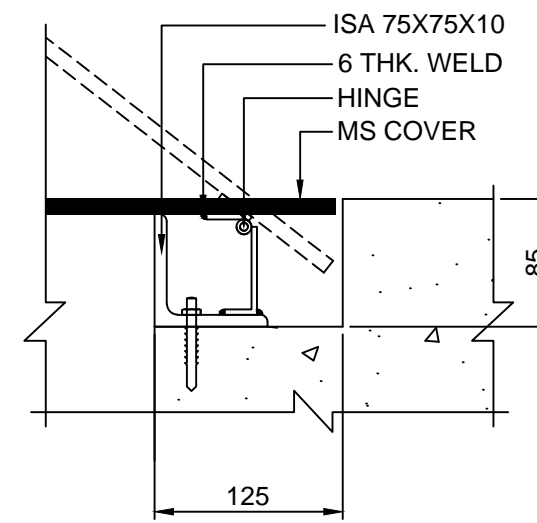

DETAIL 'A'
SCALE 1:5

KEY PLAN

NOTES :-

REFERENCE DRG. NO.

LEGEND :-

WTE DRAWING FOR
COMMENTS / APPROVAL
SIGNATURE _____ DATE _____

| | | | | | |
|-----|----------|-------------|-------|--------|------|
| 4 | | | | | |
| 3 | | | | | |
| 2 | | | | | |
| 1 | | | | | |
| 0 | 30.06.18 | FOR TENDER | BR | GNG MS | |
| Rev | Date | Description | Drawn | Chk. | App. |

Wadia Techno Engg. Services Ltd. Mumbai
Louis Berger

Client: SOLAPUR CITY DEVELOPMENT CORPORATION LTD.
 Project: TO DESIGN, DEVELOP, MANAGE & IMPLEMENT URBAN INFRASTRUCTURE SERVICES PROJECTS UNDER SMART CITY MISSION (SCM) IN SOLAPUR CITY
 Title: TYPICAL DETAIL OF ELECTRO MAGNETIC BULK FLOW METER

| | | | | | | | | |
|-------|---------|----------|------------|----------|------|-------|----|---|
| North | A 0 NTS | WTE-2297 | 00 | W | 2.23 | R0 | 1 | 1 |
| Scale | Job no. | Code | Discipline | Dwg. no. | Rev. | Sheet | Of | |

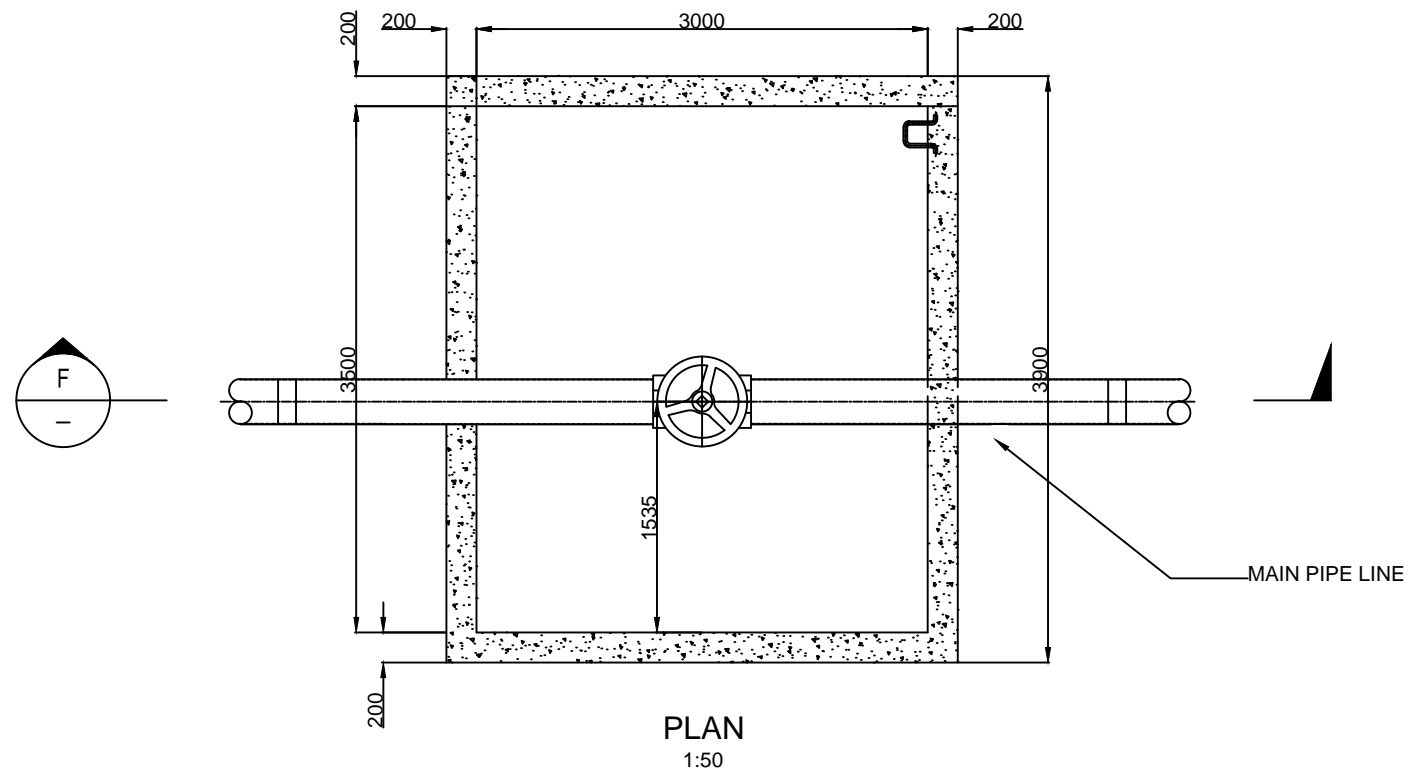

PLAN
1:50
PLAN OF PRESSURE REDUCING VALVE

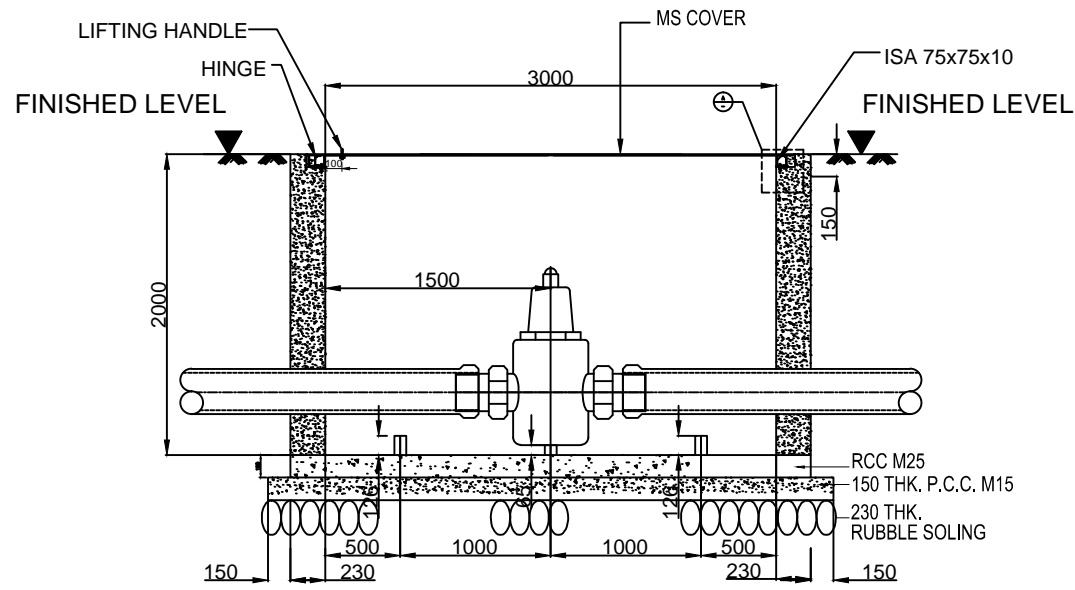

SECTION F-F
1:50
TYPICAL SECTION OF PRESSURE REDUCING VALVE

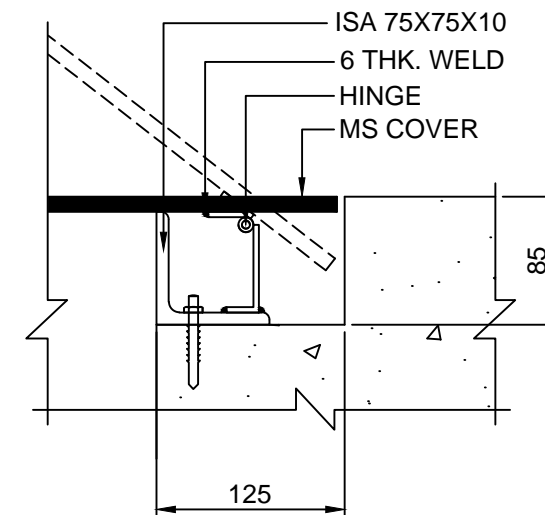

DETAIL 'B'
SCALE 1:5

KEY PLAN

NOTES :-

REFERENCE DRG. NO.

LEGEND :-

WTE DRAWING FOR COMMENTS / APPROVAL
SIGNATURE _____ DATE _____

| | | | | |
|------|----------|-------------|-------|-----------|
| 4 | | | | |
| 3 | | | | |
| 2 | | | | |
| 1 | | | | |
| 0 | 30.06.18 | FOR TENDER | BR | GNG MS |
| Rev. | Date | Description | Drawn | Chk. App. |

Wadia Techno Engg. Services Ltd. Mumbai
Louis Berger

Client: **SOLAPUR CITY DEVELOPMENT CORPORATION LTD.**
 Project: **TO DESIGN, DEVELOP, MANAGE & IMPLEMENT URBAN INFRASTRUCTURE SERVICES PROJECTS UNDER SMART CITY MISSION (SCM) IN SOLAPUR CITY**
 Title: **TYPICAL DETAIL OF PRESSURE REDUCING VALVE**

| | | | | | | | | |
|-------|---------|-----------------|------------|-----------|------|-------|----|---|
| North | A 0 NTS | WTE-2297 | 00 | W | 2.24 | R0 | 1 | 1 |
| Scale | Job no. | Code | Discipline | Drwg. no. | Rev. | Sheet | Of | |

DRG. NO. -

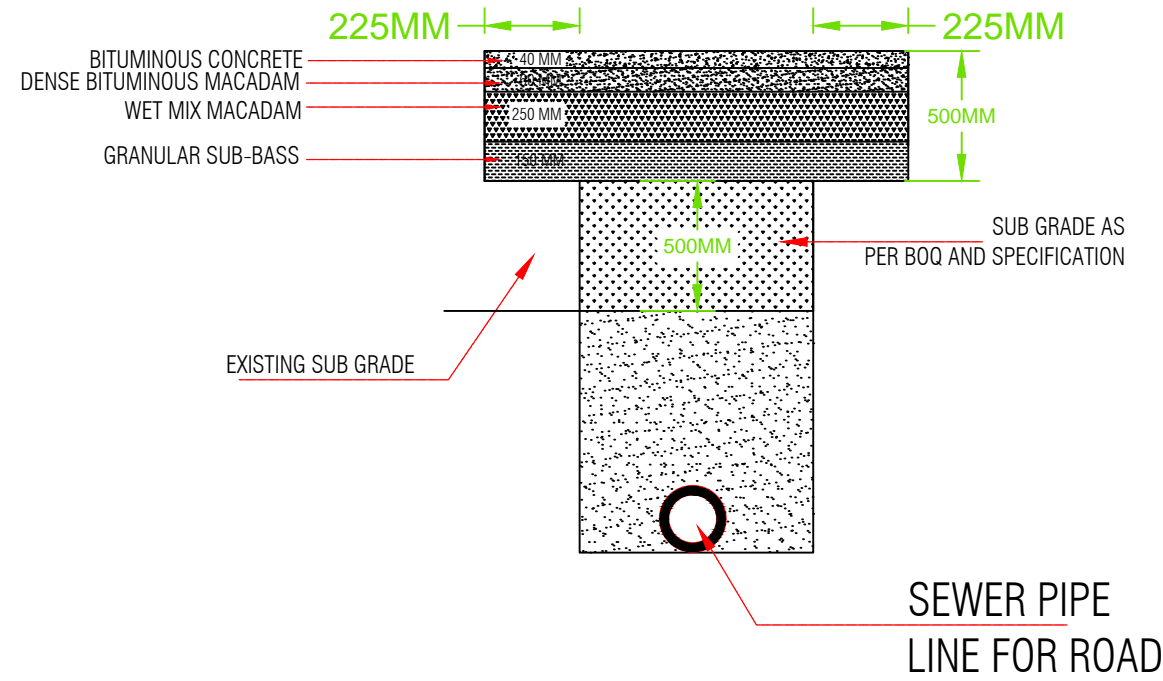

TYPICAL DETAILS 'A' FOR ROAD RESTORATION OF ROAD PAVEMENT IN BITUMINOUS LAYER

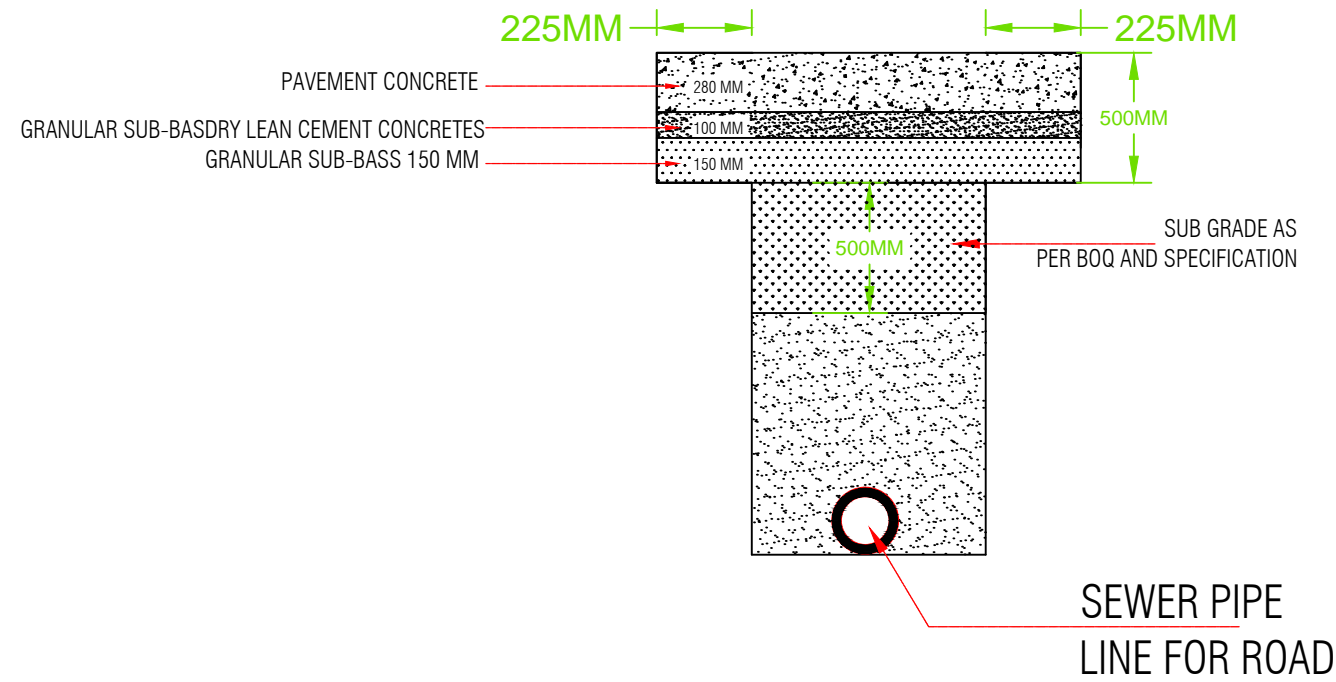

TYPICAL DETAILS 'A' FOR ROAD RESTORATION CONCRETE OF ROAD PAVEMENT CONCRETE

KEY PLAN

NOTES :-

REFERENCE DRG. NO.

LEGEND :-

WTE DRAWING FOR COMMENTS / APPROVAL

SIGNATURE _____ DATE _____

| 4 | | | | | |
|------|----------|-------------|-------|------|------|
| 3 | | | | | |
| 2 | | | | | |
| 1 | | | | | |
| 0 | 12.08.18 | | | AN | |
| Rev. | Date | Description | Drawn | Chk. | App. |

WTE Wadia Techno Engg. Services Ltd. Mumbai

Louis Berger

Client: SOLAPUR CITY DEVELOPMENT CORPORATION LTD.

Project: TO DESIGN, DEVELOP, MANAGE & IMPLEMENT URBAN A3 INFRASTRUCTURE SERVICES PROJECTS UNDER SMART CITY MISSION (SCM) IN SOLAPUR CITY.

Title: TYPICAL DETAILS FOR ROAD RESTORATION

Scale: NTS **WTE-2297** 00 W R0

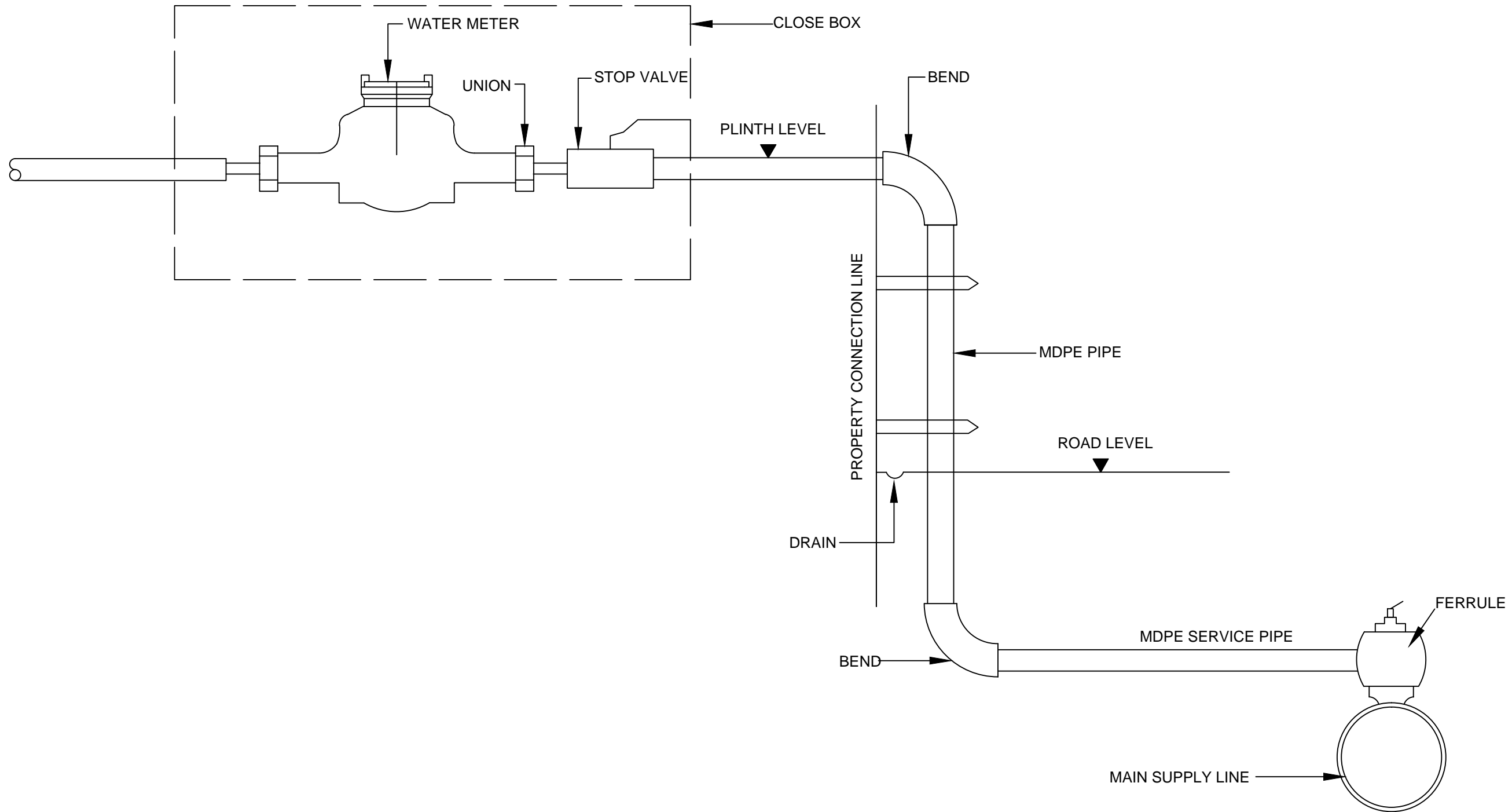

KEY PLAN



NOTES :-

REFERENCE DRG. NO.

LEGEND :-

WTE DRAWING FOR COMMENTS / APPROVAL
SIGNATURE _____ DATE _____

| | | | | | |
|------|----------|-------------|-------|------|------|
| 4 | | | | | |
| 3 | | | | | |
| 2 | | | | | |
| 1 | | | | | |
| 0 | 30.06.18 | FOR TENDER | BR | GNG | MS |
| Rev. | Date | Description | Drawn | Chk. | App. |



Wadia Techno Engg. Services Ltd. Mumbai

Louis Berger

Client:  **SOLAPUR CITY DEVELOPMENT CORPORATION LTD.**
 Project: TO DESIGN, DEVELOP, MANAGE & IMPLEMENT URBAN INFRASTRUCTURE SERVICES PROJECTS UNDER SMART CITY MISSION (SCM) IN SOLAPUR CITY
 Title: TYPICAL DETAIL OF HOUSE SERVICE CONNECTION

| | | | | | | | | |
|-------|---------|-----------------|------|------------|---------|------|-------|----|
| North | A 0 NTS | WTE-2297 | 00 | W | 2.25 | R0 | 1 | 1 |
| | Scale | Job no. | Code | Discipline | Dwg.no. | Rev. | Sheet | Of |

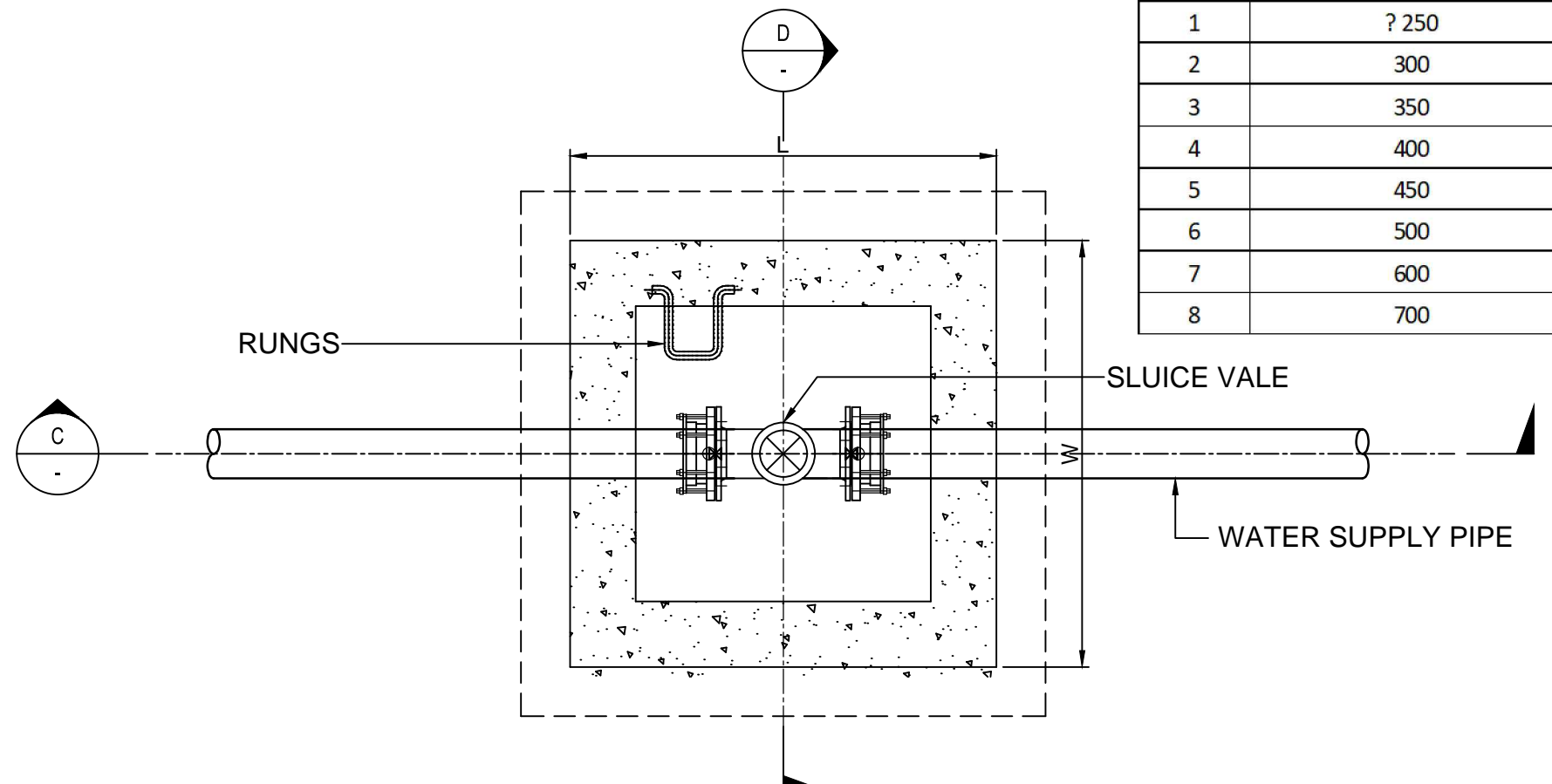
| Sizes of valve Chamber for Sluice Valve | | | | |
|---|---------------------------------------|-----------------------|------------|------------|
| Sr. No | Diameter of the Sluice valve in mm | Size of valve chamber | | |
| | | Length in m | Width in m | Depth in m |
| 1 | 250 | CI Road Box | | |
| 2 | 300 | 1.2 | 1.3 | 1.8 |
| 3 | 350 | 1.2 | 1.3 | 1.8 |
| 4 | 400 | 1.2 | 1.3 | 1.8 |
| 5 | 450 | 1.3 | 2 | 2.2 |
| 6 | 500 | 1.3 | 2 | 2.2 |
| 7 | 600 | 1.3 | 2 | 2.2 |
| 8 | 700 | 1.3 | 2 | 2.2 |

- NOTES :-**
1. THE SIZE OF CHAMBER ARE TABULATED IN THE DRAWING HEREWITH.
 2. THE SIZE OF SLUICE VALVE CHAMBER MAY CHANGE ON SITE AS PER SITE CONDITION.
 3. THE STRUCTURAL DESIGN SHOULD BE CARRIED OUT BEFORE EXECUTION OF THE SLUICE VALVE CHAMBER



PLAN
1:20

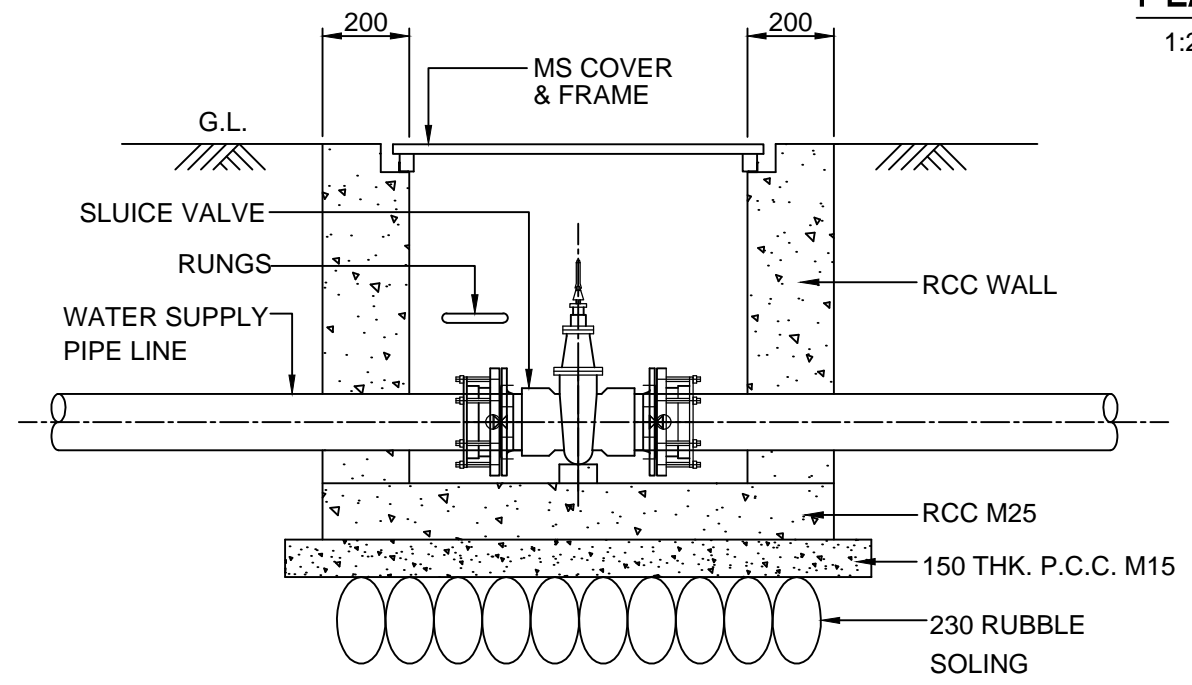

SECTION C-C
SCALE 1:20

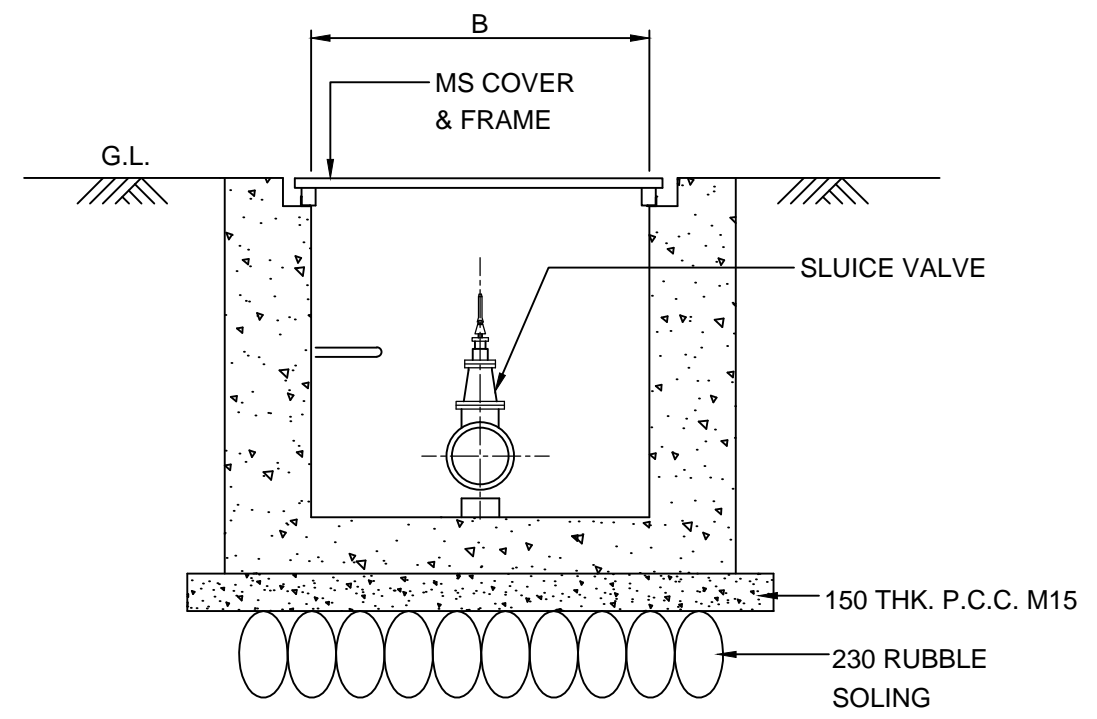

SECTION D-D
SCALE 1:20

TYPICAL DETAILS OF SLUICE VALVE CHAMBER
SCALE 1:20

- LEGEND :-**
1. G.L. = GROUND LEVEL
 2. L = LENGTH IN M.
 3. W = WIDTH IN M.

WTE DRAWING FOR COMMENTS / APPROVAL
SIGNATURE _____ DATE _____

| | | | | |
|-----|----------|-------------|-------|----------|
| 4 | | | | |
| 3 | | | | |
| 2 | | | | |
| 1 | | | | |
| 0 | 06.08.18 | FOR TENDER | BR | GNG MS |
| Rev | Date | Description | Drawn | Chk. App |

WTE Wadia Techno Engg. Services Ltd. Mumbai

Louis Berger

Client: SOLAPUR CITY DEVELOPMENT CORPORATION LTD.

Project: DESIGN, DEVELOP, MANAGE & IMPLEMENT URBAN INFRASTRUCTURE SERVICES PROJECTS UNDER SMART CITY MISSION (SCM) IN SOLAPUR CITY

Title: TYPICAL DETAIL OF SLUICE VALVE CHAMBER

| | | | | | | | | |
|-------|---------|----------|------------|-------|------|-------|----|---|
| North | A 0 NTS | WTE-2297 | 00 | W | 4.21 | R0 | 1 | 1 |
| Scale | Job no. | Code | Discipline | Drawn | Rev. | Sheet | Of | |

RESIDUAL CHLORINE ANALYZER

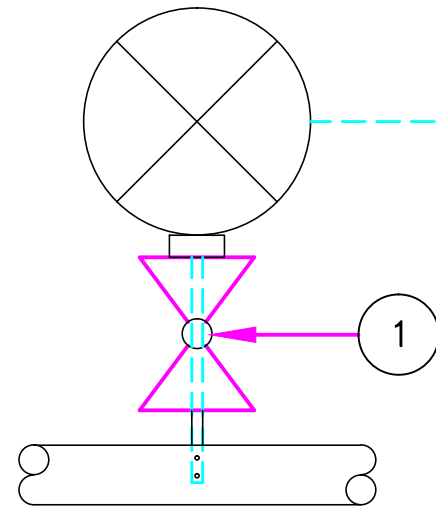

HEADER PIPE

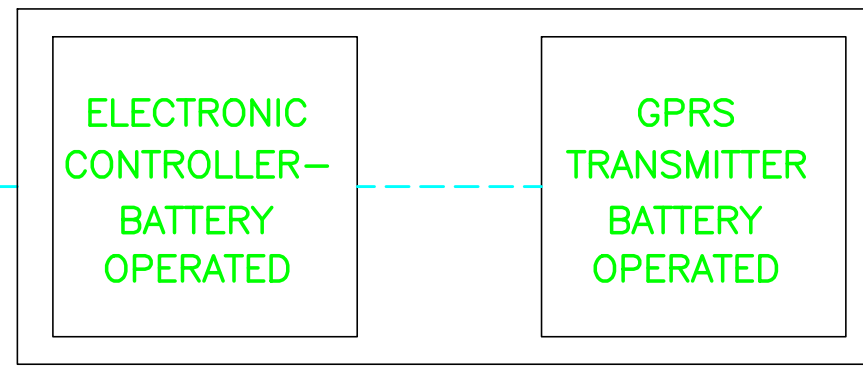

JUNCTION BOX

LIST OF ITEMS

| ITEM. NO. | DESCRIPTION | SIZE | MOC |
|-----------|----------------------------|-----------|-----|
| 1 | HOT RETRACTABLE BALL VALVE | 15 NB, SW | SS |

NOTES :-

01) THE QUALITY ANALYZER (RESIDUAL CHLORINE) SHOULD BE INSTALLED AS PER SPECIFICATION GIVEN IN THE ENDER.

02) THE CONSTRUCTION DRAWING SHOULD BE SUBMITTED AND GET APPROVED BY IC AND ENGINEER IN CHANGE BEFORE.

LEGEND :-

TYPICAL HOOK UP DRAWING FOR RESIDUAL CHLORINE ANALYZER

WTE DRAWING FOR COMMENTS / APPROVAL
SIGNATURE _____ DATE _____

| | | | | |
|-----|----------|-------------|-------|----------|
| 4 | | | | |
| 3 | | | | |
| 2 | | | | |
| 1 | | | | |
| 0 | 04.08.18 | FOR TENDER | BR | GNG MS |
| Rev | Date | Description | Drawn | Chk. App |

File name :- Typical Arrangement Drawing For Pressure Loggers.dwg

WTE Wadia Techno Engg . Services Ltd. Mumbai  Louis Berger

Client: SOLAPUR CITY DEVELOPMENT CORPORATION LTD.

Project: DESIGN, DEVELOP, MANAGE & IMPLEMENT URBAN INFRASTRUCTURE SERVICES PROJECTS UNDER SMART CITY MISSION (SCM) IN SOLAPUR CITY

Title: TYPICAL DRAWING FOR RESIDUAL CHLORINE ANALYZER.

| | | | | | | | | |
|-------|-----|----------|------|------------|---------|------|-------|----|
| North | A 0 | WTE-2297 | 00 | W | 2.27 | R0 | 1 | 1 |
| Scale | NTS | Job no. | Code | Discipline | Dwg.no. | Rev. | Sheet | Of |