

**SURAT MUNICIPAL CORPORATION  
SOUTH ZONE (UDHNA)**

**Name of work : CONSTRUCTION OF INNOVATION, INCUBATION, START UP AND TRADE FACILITATION CENTRE UNDER SMART CITY MISSION (PHASE-1) AT EXISTING SEPC BUILDING AT T.P. SCHEME NO.1 (UDHNA-MAJURA), F.P. NO.79 IN SOUTH ZONE (UDHNA), SURAT**

E-Tender

Tender (On Line) Notice No. SSCDL-TEN-02-2017-18

Work no. 01

**VOLUME-I : TECHNICAL BID**

START DATE OF DOWNLOAD OF TENDER DOCUMENTS FROM website smc.nprocure.com	:	From Dt. <b>19/02/2018</b> to <b>01/03/2018</b> , upto 18:00 hrs.
DATE OF PRE-BID QUERIES	:	Bidder shall have to post queries on Email address <a href="mailto:exen.sz@suratmunicipal.org">exen.sz@suratmunicipal.org</a> on or before <b>28/02/2018</b> up to 18.00 hrs.
LAST DATE OF SUBMISSION OF ONLINE TENDER (TENDER FEES, EMD AND OTHER DOCUMENTS IN SOFT COPY)	:	Upto Dt. <b>01/03/2018</b> up to 18.00 hrs
LAST DATE OF SUBMISSION OF TENDER FEES, EMD AND OTHER DOCUMENTS IN HARD COPY	:	Up to Dt. <b>08/03/2018</b> up to 18.00 hrs. to Chief Accountant, SMC, Muglisara, Surat by R.P.A.D./Speed Post
OPENING OF TECHNICAL BID ALONG WITH OTHER DOCUMENT RECEIVED IN SOFT AND HARD COPY.	:	Dt. <b>09/03/2018</b> up to 16.00 hrs onward (Probable)
ESTIMATED AMOUNT	:	<b>Rs. 2,89,01,429.33</b>
EARNEST MONEY DEPOSIT.	:	<b>Rs. 2,89,500/-</b>
DOCUMENT FEES	:	<b>Rs. 3,600.00 + 12 % G.S.T. = Rs. 4032.00</b>
CLASS	:	<b>" B "</b>

TENDER TO BE SUBMITTED TO:

THE CHIEF ACCOUNTANT,  
SURAT MUNICIPAL CORPORATION, MUGLISARA  
SURAT – 395 003.



**SURAT MUNICIPAL CORPORATION  
TENDER DOCUMENT  
I N D E X**

<b>SR. NO.</b>	<b>PARTICULARS</b>	<b>PAGE NO.</b>
1.	NOTICE INVITING TENDER	03
	ANNEXURE-I (Performa for list of works of similar nature already completed by the Tenderer during last 7 years.)	06
	ANNEXURE-II (Performa for declaration regarding work on hand with the tender.)	07
	ANNEXURE-A (AFFIDAVIT)	08
2.	CONTRACTOR TO PLEASE READ THID CAREFULLY	09
3.	DECLARATION FORM	11
4.	INSTRUCTION TO TENDERER	12
5.	FORMAT FOR BANK GAURANTEE	21
6.	GENERAL RULES AND DIRECTIONS FOR THE GUIDANCE FOR CONTRACTOR	23
7.	GENERAL CONDITIONS OF CONTRACT	25
8.	SCHEDULE-A	46
9.	MEMORANDUM	47
10.	CONDITION FOR THE WATER SUPPLY AND ELECTRIC SUPPLY	48
11.	IMPORTANT INSTRUCTION-A TO THE CONTRACTOR	49
12.	IMPORTANT INSTRUCTION-B TO THE CONTRACTOR	50
13.	DETAILED SPECIFICATION OF MATERIALS	51
14.	GENERAL TECHNICAL SPECIFICATION FOR THE BUILDING WORKS	68
15.	ITEMWISE DETAILED TECHNICAL SPECIFICATIONS	69
16.	SPECIFICATION FOR ELECTRICAL INSTALLATION	150
17.	SPECIFICATION CONCEALED CONCUIT WIRING SYSTEM	153
18.	SPECIAL CONDITION	155
19.	DRAWINGS	156



**SURAT MUNICIPAL CORPORATION  
SOUTH ZONE (UDHNA)**

**1.0 NOTICE INVITING TENDER**

**(A) RECEIPT AND OPENING OF TENDER :**

Online Tenders will be received from the established and reliable contractors on or before 24.00 hours From **19/02/2018 to 01/03/2018** up to 18.00 hrs. on website smc.nprocure.com. The tender received after due time and date specified will not be accepted.

**CONSTRUCTION OF INNOVATION, INCUBATION, START UP AND TRADE FACILITATION CENTRE UNDER SMART CITY MISSION (PHASE-1) AT EXISTING SEPC BUILDING AT T.P. SCHEME NO.1 (UDHNA-MAJURA), F.P. NO.79 IN SOUTH ZONE (UDHNA), SURAT**

1. ESTIMATED COST : **Rs. 2,89,01,429.33**
2. EARNEST MONEY DEPOSIT : **RS. 2,89,500.00**
3. TIME LIMIT : **06 (Six) months (Excluding monsoon)**
4. DOCUMENT FEE : **Rs. 3,600.00 +12.00% GST = Rs. 4032.00**
5. REGISTRATION REQUIRED : **' B ' class**

**(C) OPENING OF TENDERS :**

The tenders will be opened online in presence of bidders and opening authority subject to receipt of **Tender Fees & EMD & ANNEXURE- A (Affidavit) in hard copy in account department (Main Office) . But tenderer has to upload relevant documents as required /mentioned in the technical bid in Soft Copy (By Scanning)** .The tenders will be opened in two stages i.e Technical Bid and Commercial Bid.

**(D) PURCHASE OF TENDER DOCUMENTS :**

Tender Documents can be downloaded from smc.nprocure.com From **19/02/2018 to 01/03/2018** upto 18.00 hrs.

Tender documents fees of **Rs. 3,600.00 + 12.00 % GST = Rs. 4032.00** per set which is required for submission of tender towards the cost of tender documents in cash, pay order or by demand draft of any nationalized bank, in favour of "The Commissioner, Surat Municipal Corporation" payable at Surat and shall be submitted alongwith EMD and other documents. The cost of the Tender Documents will not be refunded in any circumstances. The Surat Municipal Corporation shall not be liable for any postal delay in any case.

- **E.M.D & Tender Fee shall be submitted in electronic format only through online(by scanning) while uploading the bid. this submission shall mean that E.M.D and tender fee are received for purpose of opening the bid. Accordingly, offer/tenders of those tenderers whose E.M.D & tender fee is received electronically, shall be opened. However, for the purpose of realization of EMD and Tender fee ,bidder shall send the EMD as well as Tender fee in required format in original through RPAD/Speed post so as to reach to Account Department (Main office) within stipulated date as mentioned in tender notice for the submission of tender FEE & E.M.D .Punitive action shall be initiated for non submission of EMD & Tender fees in original to Account Department (Main Office)by bidder including abeyance of registration and cancellation of E – tendering code for one year. all documents in supporting of bid shall be in electronic format only through online (by Scanning) during the bidding period & hard copy will not be accepted separately.**
- **All documents must be coloured scanned to be seen as original. Scanning in black and white or gray shall not be acceptable.**
- **All the documents must be notarised with clearly displaying stamp, number and name of the notary.**

**(E) CONTRACT PERIOD :**

The total contract period is hereby fixed as **06 (Six) months (Excluding monsoon)** from the 10<sup>th</sup> Day of issuance of work order.



- (F) Tenderer must comply with and agree to all instructions & requirements in the Notice and in the Instructions to Tenderers, including requirements in the Contract Documents.
- (a) All tenders must be submitted in the prescribed Tender form.
  - (b) Each Tender must be accompanied by the completion Schedule.
  - (c) Each tender must be accompanied by the Tender Security (Earnest Money Deposit) **Rs. 2,89,500.00/-**
  - (d) The successful tenderer shall execute the Contract Agreement within fifteen days after the date of Notice of award.
  - (e) The successful Tenderer will be required to furnish a performance bond (Security Deposit) of and amount equal to (2%) Two percent of the tendered amount.
  - (f) The successful Tenderer shall furnish insurance in accordance with the contract documents.
  - (g) The Surat Municipal Corporation may withhold issuance of the Notice of proceed for a period not exceeding fifteen days after the date of execution of the contract agreement.
  - (h) The tender and tender guarantee bond (Earnest Money Deposit) shall be submitted by the Agency in whose name tender has been issued. Transfer of tender documents to any other party is prohibited.
  - (i) All intending tenderers will have to purchase digital signatures in order to participate in the online bidding process.
  - (j) **All the applicant contractors are required to have their own employers code number under EPF Act, 1952 and are required to comply the applicable provisions of said statute regularly and totally.**
  - (k) **Further the contractors for services are required to produce the certified copies of paid challans in respect of employees/workers employed by said contractor in respect of work allotted by Surat Municipal Corporation, along with copies of Pay Roll and Muster Roll. If the same are not produced, the bills will not be released.**

(G) RECEIPT OF TENDER DOCUMENTS :

The following details are to be submitted online on smc.nprocure.com :

- a. Document fees and EMD in prescribed format
- b. Commercial Bid
- c. Annexure I to II along with all necessary supporting documents

The following details shall be submitted in hard copy at prescribed address :

- a. Tender fees in prescribed format
- b. Earnest Money Deposit in prescribed format
- c. Affidavit as per Annexure A on Non Judicial Stamp Paper of Rs.100/-
- d. Addenda, if any.

**Please note that commercial bid shall not be submitted in hard copy under any circumstances. This will hold the tender liable for rejection.**

(H) Tender Validity Period :

The validity period of the tender submitted for this work shall be of one hundred twenty (120) calendar days from date of opening of the price bid for this work and the Tenderer shall not be allowed to withdraw or modify the tender offer on his own during the validity period.

(I) Rights Reserved :

Without assigning any reason, The Surat Municipal Corporation reserves the right to reject the lowest or any other or all tenders or part of its. To waive any informality or irregularity in any tender, which in the opinion of the Surat Municipal Corporation does not appear to be in its best interest and the tenderer shall have no cause of action or claim against the Surat Municipal Corporation or its officers, employee, successors or assigners for rejection of this tender.

The Surat Municipal Corporation further reserves the right to withhold issuance of the notice to proceed, after execution of the contract agreement by the successful Tenderer. The Surat Municipal Corporation is not obliged to give reasons for any such action.



During Tender validity period, if any Tenderer withdraws or makes any modifications or additions in the terms and conditions on his own in this tender, then The Surat Municipal Corporation shall without prejudice to any right or remedy be at liberty to reject the tender and forfeit the Earnest Money Deposit in full. Such Tenderer may be disqualified from tendering for further works under the jurisdiction of The Surat Municipal Corporation.

The Surat Municipal Corporation reserves the right to increase or decrease the scope of work and split the tender in two or more parts without assigning any reason even after the award of contract.

SIGNATURE OF CONTRACTOR

EXECUTIVE ENGINEER,  
SOUTH ZONE (UDHNA)  
SURAT MUNICIPAL CORPORATION



ANNEXURE-I TO II FOR PRE-QUALIFICATION  
TO BE FILLED IN BY TENDERER  
**ANNEXURE-I**

Performa for list of works of similar nature already completed by the  
Tenderer during last 7 years.

Sr. No.	Name of work and Place	Cost on Completion	Time taken in months to complete the work	Client name	Date of completion
1	2	3	4	5	6

Note: Bidder shall give completion certificate from client. In absent of such completion certificate, experience shall not be considered for evaluation. If completion certificate covers "Similar work (as per IT-04) with other work" then bidders shall have to submit copies of final bill indicating similar work or certificate of amount including "Similar work" from relevant authority.

Please Fill above details and attach in separate sheet.

Signature of the Contractor  
With seal.

Place:

Date

**ANNEXURE-II**

Performa for declaration regarding work on hand with the tender:

Sr. No.	Name of work with place	Estimated Cost	Date of Issue of work order	Stipulated period of completion	Amount of work done	Brief details of delay if any	Name of client
1	2	3	4	5	6	7	8

Present liability = Total of column 3 - Total of column-6

Signature of the Contractor  
with seal

Place

Date:

Note: Amount of work done in Column 6, should be given up to the month previous to the month in which tender are invited.

Please Fill above details attached separate sheet.

**ANNEXURE-A****AFFIDAVIT**

Name of Work: \_\_\_\_\_

- I, the undersigned, do hereby certify that all the statements made in the required attachments are true and correct. I also understand that in case of wrongful/false information, corporation is entitled to take any civil & criminal punitive action against me / us.
- The undersigned also hereby certifies that neither our firm M/s \_\_\_\_\_ nor any of its constituent partners have abandoned any work in India nor any contract awarded to us has been rescinded during last five years, prior to the date of this bid.
- The undersigned hereby authorize(s) and request(s) any bank, person, authorities, government or public limited institutions, firm or corporation to Furnish pertinent information deemed necessary and requested by the SMC to verify our statements of our competence and general reputation etc.
- The undersigned understands and agrees that further qualifying information may be requested, and agrees to furnish any such information at the request of the SMC.
- The SMC and its authorized representatives are hereby authorized to conduct any inquiries or investigations to verify the statements, documents, and information submitted in connection with this bid and to seek clarification from our bankers and clients regarding any financial and technical aspects. This Affidavit will also serve as authorization to any individual or authorized representative to any institution referred to in the supporting information, to provide such information deemed necessary and requested by representative of Surat Municipal Corporation to verify statements and information provided in the Tender or with regard to the resources, experience and competence of the Applicant.

\_\_\_\_\_  
Signed by the Authorize signatory of the firm\_\_\_\_\_  
Title of the office\_\_\_\_\_  
Name of the firm

Date:

Note:- The affidavit format as indicated above to be furnished on non-judical stamp paper of Rs.100 and duly notarized.





## SURAT MUNICIPAL CORPORATION

## SOUTH ZONE (UDHNA)

## CONTRACTOR TO PLEASE READ THIS CAREFULLY

- (1) If the tender is taken in favour of the company, a copy of attorney in favour of the person who may have signed the tender for the company, must accompany the tender.
- (2) Solvency certificate of current year Bank or a Revenue Officer of an amount upto 20% of the tender cost plus works on the hand still to be executed will have to be produced by the contractor.
- (3) Voucher for earnest money must accompany the tender. Tenderer may pay earnest money in form of a crossed demand draft of a local Bank drawn in favour of the Municipal Commissioner. Earnest Money by cheque OR FDR shall not be accepted.
- (4) The contractor shall have to furnish income tax clearance certificate before his tender is accepted and intimate assessment No. and Ward under he is which assessed.
- (5) **Copies of certificate as regards previous experience of Govt. or Semi Govt. Dept., if any must accompany the tender. An attested copy of registration with MES, Various department of State Govt., Surat Municipal Corporation, CPWD etc.**
- (6) Declaration showing all works on hand with the contractor and the value of works that remains to be executed in each case must accompany the tender.
- (7) All pages of Schedule: `A & B' & specification should be initialed by the contractor.
- (8) All corrections, erasures & over writing should be initialed by the contractor.
- (9) Descripancies and adjustment of errors:-Any error in quantity or amount in Schedule-`B' showing item of words to be carried out shall be adjusted in accordance with the following rules:-
  - (a) In the event of a discrepancy between description in works and figures quoted by a tenderer in the `rates' column, the descriptions in words shall prevail.
  - (b) In the event of and error occuring in the amount column of the Schedule- `B' showing items of works as a result of worgn multiplication of the unit rate and quantity, the units rate shall be regarded as firm and multiplication shall be amended on the basis of the rate.
  - (c) All the errors in totalling in amount column and in carrying forwarded total shall be corrected.
  - (d) Any rounding of amounts against item' or in totals' shall be ignored.  
The tendered sum so altered shall, for the purpose of the tenders, be substituted for the sum originally tendered and considered for acceptpance.
- (10) (i) It may please be noted that the tender shall be considered as invalid specially, if the requirements as per insiruction No.1 to 9 above are not compleied with before submitting the tender. Also please read carefully the face sheet and "General Rules and Direction for the suidance of contractor" of his form.  
(ii)Right is reserved to reject any or all tender (s) without assigning any person (s) thereof.
- (11) In addition to the above the tender will also be liable to rejected outright if :-
  - (i) The tenderer proposes any alteration in the works specified or in the time allowed for carryin out the work or any conditions or correction made in any code or made of Schedule-`B' or specifications.
  - (ii) Any of the page or pages of the tender is removed or replaced.
  - (iii) All corrections, additions or pasted slips are not initialed by the tenderer.
  - (iv) Any erasures is made by him in the tender
  - (v) The tenderer or in the case of a firm, each partner or person holding the power of attorney thereof does not signed or the signature/s is/are not attested by awitness on page-9 of the tender in the space for the purpose.
- (12) In respect of the tenders from the co-operative society, a solvency certificate of an amount equal to 20% of the amount of the work put to tender will have to be produced alongwith the tender or a certificate regarding the borrowing capacity if the society issued by the leagal Assistant, Directorate of Cottage Industries will have to be produced alongwith the tender.
- (13) (1) The serveral documents forming the contract are the essential part of the contract and requirement occuring in one is as binding as through occuring in all, they are intended to be mutually explantory and complementary and to described and provide for a complete work.  
(2) In the event of any descrcpeaney, the serveral documents forming the contract or in any the document, the following order or precedence should apply:-
  - (a) Dimension & quantities :-
    - (i) Drawings.
    - (ii) Schedule-B of the tender form.



(iii) Specification.

On drawings, figures, dimensions, unless obviously incorrect will followed in preference to seeled dimensions.

(b) Description :

(i) Scheudule-B of the tender form.

(ii ) Drawings.

(iii) Specifications.

In case of defective description or ambiguity, the Engineer- in-charge should issue further instructions direction in what meanner the work is to be carried out it being understood that the best modern practice is to followed. The contractor should forthwith comply with such instructions.

(3) The contractor should taken no advantage of any apparent error or omission in drawings or specification and the Engineer in charge shall make such corrections and interpretation as necessary to fulfil the intent of the Plans and specifications.

(4) No with standing that all proper precautions may have been taken by contractor at all the times during the progress of the work, the contract shall be held responsible for all damages whether to the work under execution or to any other property or to lives of persons during the progress of the work and the period of maintance.

(5) Plans are for rough guidance only when detailed plans are received from the Architect of corporation during the course of execution the same will supersede previous plans

14. The contractor should appoint a qualified engineer and he must remain present on site during working hours.

**15 The Quantity mentioned in the scheduled "B" is Tentative (indicative) for each item. Tender shall have to execute the concerned work/item as per the site condition and payment shall be made accordingly as per the actual measurement of the particular item.**

**16 As per Commissioner Note No.C.N.129, dtd. 9/9/2016**

- **E.M.D & Tender Fee shall be submitted in electronic format only through online(by scanning) while uploading the bid. this submission shall mean that E.M.D and tender fee are received for purpose of opening the bid. Accordingly, offer/tenders of those tenderers whose E.M.D & tender fee is received electronically, shall be opened. However, for the purpose of realization of EMD and Tender fee ,bidder shall send the EMD as well as Tender fee in required format in original through RPAD/Speed post so as to reach to Account Department (Main office) within stipulated date as mentioned in tender notice for the submission of tender FEE & E.M.D .Punitive action shall be initiated for non submission of EMD & Tender fees in original to Account Department (Main Office)by bidder including abeyance of registration and cancellation of E – tendering code for one year. all documents in supporting of bid shall be in electronic format only through online (by Scanning) during the bidding period & hard copy will not be accepted separately.**
- **All documents must be coloured scanned to be seen as original. Scanning in black and white or gray shall Not be acceptable.**
- **All the documents must be notarised with clearly displaying stamp, number and name of the notary.**

EXECUTIVE ENGINEER,  
SOUTH ZONE (UDHNA),  
SURAT MUNICIPAL CORPORATION

SIGNATURE OF CONTRACTOR



DECLARATION FORM

(1) I/We hereby declare that I/We have visited the site and fully acquainted myself/ourselves with the local situation regarding materials, labour and other factors pertaining to the work before submitting this tender.

(2) I/We hereby declare that I/We have carefully studied the conditions of contract, specifications and other tender documents of this work and agree to execute the same accordingly.

Contractor Signature with  
Seal & Address:  
Date :

EXECUTIVE ENGINEER  
SOUTH ZONE (UDHNA)  
SURAT MUNICIPAL CORPORATION

**INSTRUCTION TO TENDERERS****IT-01 GENERAL :**

The Contract documents may be secured in accordance with the notice Inviting Tender for the work called. The work shall include supply of materials necessary for construction of the work.

**IT-02 INVITATION TO TENDER:**

The Surat Municipal Corporation hereinafter referred to as the Corporation invites tenders for the work of **CONSTRUCTION OF INNOVATION, INCUBATION, START UP AND TRADE FACILITATION CENTRE UNDER SMART CITY MISSION (PHASE-1) AT EXISTING SEPC BUILDING AT T.P. SCHEME NO.1 (UDHNA-MAJURA), F.P. NO.79 IN SOUTH ZONE (UDHNA), SURAT** as per the specifications in the tender documents. The tenders shall be opened in presence of opening authority, smc in the presence of tenderers or their representatives who are present. The Corporation reserves the right to reject the lowest or any other or all tenders or part of it which in the opinion of the Corporation does not appear to be in its best interest, and the tenderer shall have no cause of action or claim against the corporation or its officers, employees, successors or assignees for rejection of his tender.

**IT-03 LANGUAGE OF TENDER :**

Tenders shall be submitted in English, and all information in the tender shall also be in English, Information in any other language shall be accompanied by its translation in English. Failure to comply with this may make the tender liable to reject.

**IT-04 QUALIFICATIONS OF TENDERERS:-**

(A) Tenderer shall be required to submit the enlisted documents along with E.M.D. and tender fees in soft copy (By Scanning). EMD and Tender fee shall be submitted in hard copy also and in prescribed form for realisation. If documents are insufficient or it does not match the required criteria mentioned below, then the Price Bid of the tenderer shall not be opened.

Mainly tenderer shall fulfill following for the pre-qualification.

(a) Experience of having successfully completed similar works during last 7 years either of the following:

(1a) Three similar completed works, each costing not less than amount equal to 40% of the estimated cost.

OR

(2a) Two similar completed works, each costing not less the amount equal to 50% of the estimated cost.

OR

(3a) One similar completed works, costing not less the amount equal to 80% of the estimated cost.

**NOTE:- Similar work shall mean construction of R.C.C Frame Structure Building including electrification work**

(b) Turnover during last 3 years, ending 31st March of previous financial year should be atleast 30% of Estimated Cost. An attested copy of annual turnover for last 3 years should be enclosed.

(c) Solvency certificate from bankers of Nationalized bank for the 20% of tender amount. Tenderer has to submit higher amount of bank solvency if so desired by Commissioner, SMC

(d) An attested copy of registration with MES, Various department of State Govt., Surat Municipal Corporation, CPWD etc.

(e) List of the works already completed in last 7 years in prescribed proforma as per Annexure-I and attested copies of certificates from head of the office concerned for completion of the works.

Following enhancement factors will be used for the cost of works executed and financial figures to amount base for the value of the works completed in India.

Financial Year	Multiplying factor
One (2016-17)	1.10
Two (2015-16)	1.21
Three (2014-15)	1.33
Four (2013-14)	1.46
Five (2012-13)	1.61
Six (2011-12)	1.77
Seven (2010-11)	1.95



Bidder should indicate actual figures of cost and the amount for the work executed in Annexure-I without accounting for the above mentioned factors.

(f) Declaration regarding the work on hand with the tenderer should also be given in prescribed performa as per Annexure-II. Attested copies of work orders, interim certificates if any shall also be attached as supporting documents.

(g) Attested copy of partnership deed, power of attorney etc.

**IT-05 TENDER DOCUMENTS :**

Printed and online documents and set of drawings shall comprehensively be referred to as Tender documents. The several sections forming the documents are the essential parts of the contract and a requirement occurring in one shall be binding as though occurring in all. They are to be taken as mutually explanatory and describe and provide for complete works.

**IT-06 EXAMINATION BY TENDERERS :**

A. At his own expenses and prior to submitting his tender, each tenderer shall (a) examine the contract Documents, (b) visit the site and determine local conditions which may effect the work including the prevailing wages and other pertinent cost factors, (c) familiarize himself with all CENTRAL, State and local laws, ordinance, rules, regulations and codes affecting the material supply including the cost of permits and licenses required for the work and (d) correlate his observations, investigations, and determinations with the requirements of the Tender Documents.

B. The tender quantity is approximate and may increase or decrease. Any increase or decrease in quantity will not entitle tenderer to claim any extra over the quoted rate.

C. Tender Documents be completed by legible ink, checked in a responsible manner, signed, stamped and returned together with the Tender Security Bond by the stipulated date, which shall form the Tender.

The Tenderer is required to complete :

(i) The form of tender, including the Appendices thereto Tender Security Bond and the Tender summary duly signed and stamped.

All the pages in which entries are required to be made by the tenderer are contained in the tender documents and the tenderer shall not take out or add to or amend the text of any of the documents except in so far as may be necessary to comply with any addenda issued pursuant to Clause IT-17 hereof.

**IT-07 EARNEST MONEY DEPOSIT:**

**Where the contractor is required to submit bank guarantee against payment towards any deposit e.g. EMD, SD, etc., such bank guarantees shall be produced only from any one of the following Nationalized/Schedule banks as listed below :**

- 1) Indian Bank
- 2) State Bank of India
- 3) Punjab National Bank
- 4) Bank of Baroda
- 5) Union Bank of India
- 6) Bank of India
- 7) Oriental Bank of Commerce
- 8) Canara Bank
- 9) Central Bank of India
- 10) Corporation Bank
- 11) Allahabad Bank
- 12) Indian Overseas Bank
- 13) Dena Bank
- 14) Syndicate Bank
- 15) Andhra Bank
- 16) Punjab & Sind Bank
- 17) Bank of Maharashtra
- 18) Vijaya Bank
- 19) United Bank of India
- 20) UCO Bank



Such bank guarantee should be encashable at Surat

- A. The Tender shall be accompanied by of Earnest Money Deposit **Rs. 2,89,500.00/-**. The tenderer shall pay Earnest Money Deposit to the extent of **50% in the form of Bank Guarantee** from the Nationalized Bank only issued in favour of Commissioner, Surat Municipal Corporation, Surat through Nationalized Bank only payable at Surat. The **balance of the Earnest Money Deposit is to be deposited by pay order/ Demand Draft** issued in favour of Commissioner, Surat Municipal Corporation, Surat through Nationalized Bank only payable at Surat **OR** the tenderer shall pay Earnest Money Deposit to the **100% in the form of Pay Order / Demand Draft** from the Nationalized Bank only issued in favour of Commissioner, Surat Municipal Corporation, Surat through Nationalized Bank only payable at Surat. **The earnest money deposit in the form of FDR or Cheque shall not be accepted.**  
The instruments for Earnest Money Deposit shall be issued by or payable/encashable at Surat Branch of the said nationalized bank.
- B. The Earnest Money Deposit(Tender guarantee) will be forfeited in the event, the successful tenderer fails to accept the contract and fails to submit the Performance Guarantee Bond to the owner as stipulated in this tender documents within ten days after receipt of notice of award of contract. In such case owner may disqualify the tenderer from tendering for further works, under the jurisdictions of the Corporation (S.M.C.).
- C. The Earnest Money Deposit of the successful tender shall be returned after the performance guarantee bond, as required, if furnished by the contractor.
- D. No interest shall be paid by the owner on any tender guarantee.

**IT-08 INCOME TAX CLEARANCE CERTIFICATE :**

In view of the latest circular of IT Department IT clearance certificate is not required. However the contractor shall give zerox copy of the PAN card.

**IT-09 PREPARATION OF TENDER DOCUMENTS :**

Tenderers are requested to note the following while preparing the Tender Documents:

- A. Technical bid, EMD and Tender fees shall be submitted on the Tender Form bound herein in English. All tender items and statements shall be properly filled in. Numbers shall be stated both in words and in figures where so indicated, and signatures of all persons signing shall be in longhand.
- B. Technical Bid shall be accompanied by the prescribed tender security bond and other required documents and drawings. All witnesses and sureties shall be persons of status and probity and their full names, occupations and address shall be stated below their signatures. All signatures in the Tender Documents shall be dated.
- C. Variations to the Contract Documents requested by the tenderer may be affixed to the Tender Document in the space available and duly signed and stamped. Such variations may be approved or refused by the Engineer at the time of adjudications of Tenders, and in either case the Engineer is not obliged to give reasons for his decisions.
- D. Delivery of Tenders shall comply with Notice inviting tenders as to place, date and time.
- E. Price Bid shall be submitted online. Tenderers are requested to quote for all parts of the tender.

**IT 10 SUBMISSION OF TENDERER DOCUMENT:-**

**Technical bid and price bid are not to be submitted in physical form. Please note that non submission of Technical Bid as well as price bid does not absolve the bidders from any liability created from the bid condition and bidding process. Technical-Bid and Price Bid in hard copy shall be submitted by Successful bidder upon intimation from Surat Municipal Corporation.**

- As per Commissioner Note No.C.N.129, dtd. 9/9/2016
- E.M.D & Tender Fee shall be submitted in electronic format only through online(by scanning) while uploading the bid. this submission shall mean that E.M.D and tender fee are received for purpose of opening the bid. Accordingly, offer/tenders of those tenderers whose E.M.D & tender fee is received electronically, shall be opened. However, for the purpose of realization of EMD and Tender fee ,bidder shall send the EMD as well as Tender fee in required format in original through RPAD/Speed post so as to reach to Account Department (Main office) within stipulated date as mentioned in tender notice for the submission of tender FEE & E.M.D .Punitive action shall be initiated for non submission of EMD & Tender fees in original to Account Department (Main Office)by bidder including abeyance of registration and cancellation of E – tendering code for one year. all documents in supporting of bid shall be in electronic format only through online (by Scanning) during the bidding period & hard copy will not be accepted separately.
  - All documents must be coloured scanned to be seen as original. Scanning in block and white or gray shall





not be acceptable.

- All the documents must be notarised with clearly displaying stamp, number and name of the notary.

**"Following Documents shall be submitted in HARD COPY to Surat Municipal Corporation by all bidders."**

- Earnest Money Deposit as mentioned in the tender.(i.e.D.D./Bank Guarantee)
- Tender Fees as mentioned in the tender.
- Affidavit as per Annexure A on Non Judicial Stamp Paper of Rs.100/-
- Addenda, if any.

**All necessary documents mentioned in Technical bid (if any). shall be submitted online.**

- (i) COVER-1 : Technical Bid  
E.M.D and Tender Fees for the work of **CONSTRUCTION OF INNOVATION, INCUBATION, START UP AND TRADE FACILITATION CENTRE UNDER SMART CITY MISSION (PHASE-1) AT EXISTING SEPC BUILDING AT T.P. SCHEME NO.1 (UDHNA-MAJURA), F.P. NO.79 IN SOUTH ZONE (UDHNA), SURAT** along with other Documents in Hard Copy upto **08/03/2018** up to 18.00 hrs. Also mention the name of tenderer, address, tender notice number etc. on the cover .
- (ii) PRICE BID  
Price bid for the work of **CONSTRUCTION OF INNOVATION, INCUBATION, START UP AND TRADE FACILITATION CENTRE UNDER SMART CITY MISSION (PHASE-1) AT EXISTING SEPC BUILDING AT T.P. SCHEME NO.1 (UDHNA-MAJURA), F.P. NO.79 IN SOUTH ZONE (UDHNA), SURAT** shall be submitted online.

The name of work to be written on cover shall be work **CONSTRUCTION OF INNOVATION, INCUBATION, START UP AND TRADE FACILITATION CENTRE UNDER SMART CITY MISSION (PHASE-1) AT EXISTING SEPC BUILDING AT T.P. SCHEME NO.1 (UDHNA-MAJURA), F.P. NO.79 IN SOUTH ZONE (UDHNA), SURAT** Also mention the name and the address of tenderer, tender notice number on the cover and to be submitted to the **Chief Accountant, Surat Municipal Corporation, Muglisara, Surat – 395 003.**

2. Tenderer shall be required to submit the enlisted documents as mentioned below in Cover-1. If necessary document founds insufficient then the Price Bid of the tenderer shall not be opened.
  - (a) The tender shall be accompanied by Earnest Money Deposit of **Rs. 2,89,500.00/-** The tenderer will pay Earnest Money Deposit by Pay Order/Demand Draft issued in favour of "Commissioner, Surat Municipal Corporation, Surat" by Nationalized Bank or The tenderer shall pay Earnest Money Deposit to the extent of 50% in the form of Bank Guarantee from the Nationalized Bank only issued in favour of Commissioner, Surat Municipal Corporation, Surat through Nationalized Bank only payable at Surat and the balance of the Earnest Money Deposit is to be deposited by pay order/ Demand Draft issued in favour of Commissioner, Surat Municipal Corporation, Surat through Nationalized Bank only payable at
  - (b) A covering letter detailing various considerations considered in tender shall invariably be given.
  - (c) Passport size photographs of all the partners (incase of partnership firm) to be fixed on relevant Page of the tender documents.
3.
  - (a) List of tools, plants and equipments with tenderer in detail.
  - (b) Technical establishment/staff of the tenderer in required Performa with their names, qualifications and experience.
  - (c) Tenderer shall furnish along with the tender, information regarding Income tax circle of the district in which he is assessed for income tax with PAN No.
4. Submission of a tender by a tenderer shall mean that he has read this notice and contract documents and has made himself aware of the scope and specifications of the work to be done and of conditions and nature of required quantities of materials stores, tools and plants etc. that may be required by him in carrying out the work and of local conditions and laws and bylaws of the Government, Surat Municipal Corporation and other factors bearing influence on the execution and cost of the works.



5. E.M.D., Tender Fee and other necessary document in hard copy shall be received by Registered Post A.D. or by Speed Post through Postal Authority only by the " **Chief Accountant, Surat Municipal Corporation, Muglisara, Surat .**" upto **08/03/2018** upto 18.00 hrs.

The same will be opened on the **09/03/2018, 16.00 hrs. (Technical Bid) onwards (Probable)** in the presence of the tenderers, who shall remain present in the office of "Tender opening officer, Surat Municipal Corporation, Surat. Late tenders (i.e. tenders received after the specified time of opening), delayed tender (i.e. tenders received before the time of opening but after due date and the time of receipt of tender) shall not be considered at all. Tenders received by Registered Post A.D./ Speed Post after the time and the date specified in the tender notice shall not be received by the client from the postman. Such tenders if received will not be opened and will stand rejected.

6. Tender shall stand rejected if:
1. Any eraser is made in the tender unauthenticated or any page or pages is/are removed or replaced.
  2. The tenderer shall submit the tender which satisfied each and every conditions laid down in the notice tender documents, failing which the tender will be liable for rejection.
  3. Tenderer's tender/quotation containing conditions shall be liable for rejection out rightly without assigning any reason for the same.
  4. Stipulates the validity period less than what is stated in the form or tender.
  5. Stipulates his own conditions.
  6. Does not quote his rates inclusive of Octroi duty and other terminal or sales tax or Central taxes in his rates.
  7. Does not disclose the full names and address of all his partners in the case of partnership firm.
  8. Does not pay the Earnest Money Deposit by Demand Draft/Pay order or as mentioned in the tender and Tender Fees with Technical Bid (Cover-1).
  9. Does not submit the tender before the stipulated time and specified date in the Office of **Chief Accountant, Surat Municipal Corporation** as directed.
  10. Does not attach the document mentioned/ does not submit documents required in soft copy(By scanning)
  11. The tenderer proposes any alteration in the work specified in the tender or in the time limit allowed for carrying out the work or any other condition.
7. All corrections, additions or posted slips to be initialed by the tenderer.
8. All page of tender documents including specifications should be initialed by the contractor.
9. The tenderer shall submit the tender which satisfies each and every conditions laid down in this notice and tender documents failing which the tender is liable for rejection.
10. Notice of inviting tenders shall be a part of the contract documents.
11. Acceptance of tenderer/quotation will rest with the competent authority of Surat Municipal Corporation who does not bind himself to accept the lowest and reserves the right to accept or to reject any or all quotations/tenders and no reasons will be given for acceptance or rejection thereof.
12. The contractor shall also attach list of machineries, tools, plants, equipment s which he propose to deploy for this work.
13. All octroi duty and other taxes chargeable by the Municipal Corporation shall be payable by the Contractor.
14. Tender once accepted shall be binding on the contractor even if the formal agreement is not signed.
15. Tender once offered can not be withdrawn except with the permission of head of the concerned department, Surat Municipal Corporation, Surat.
16. The successful tenderer shall be required to enter in to agreement with Municipal Corporation after placing the work order for the said work from SMC.
17. The successful tenderer may be required to furnish surety of 20% of the contract value on stamp paper if so desired by the Municipal Commissioner.
18. The tenderer s are requested to give complete specification of work quoted.
19. Unless specifically mentioned by the tenderer for the extra payment of taxes on price quoted by them it will be presumed the prices quoted are inclusive of the all taxes and no claim will be entertained for payment of extra taxes on the bills submitted by them.
20. The Price-bid will be opened only after technical clarifications are clarified.
21. Surat Municipal Corporation reserves the right to open or not to open any or all Price-bid without assigning any reason thereof.

**IT-11 TENDER VALIDITY PERIOD :**

The validity period of the tender submitted for this work shall be of one hundred twenty (120) Calendar day from the date of opening of price bid and that the tenderer shall not be allowed to withdraw or modify the tender offer on his own during the validity period. The tenderer will not be allowed to withdraw the tender or make any modifications or additions in the terms and conditions of his own in his tender. If this is done then the owner shall,





without prejudice to any right or remedy, be at liberty to reject the tender and forfeit the Earnest Money Deposit in full.

**IT-12 SIGNING OF TENDER DOCUMENTS :**

If the Tender is made by an individual it shall be signed with his full name above his current address. If the tender is made by a Proprietary firm it shall be signed by the proprietor above his name and the name of his firm with his current address.

If the tender is made by a firm in partnership it shall be signed by all the partners of the firm above their full names and current addresses, or by a partner holding the power of attorney for the firm signing the Tender in which case a certified copy of the power of attorney shall accompany the Tender. A certified copy of the partnership deed, current addresses of all the partners of the firm shall also accompany the tender.

If the tender is made by a limited company or a limited Corporation, it shall be by a duly authorised person holding the power of attorney for signing the Tender in which case a certified copy of the power of attorney shall accompany the Tender. Such limited company or Corporation may be required to furnish satisfactory evidence of its existence before the contract is awarded.

All witnesses and sureties shall be persons of status and probity and their full names, occupations and addresses shall be stated below their signatures. All signatures in the Tender document shall be dated.

**IT-13 WITHDRAWAL OF TENDERS :**

If, during the Tender validity period, the Tenderer withdraws his Tender, the Tender Security (Earnest Money) shall be forfeited and the Tenderer may be disqualified from tendering for further works under the jurisdiction of SURAT MUNICIPAL CORPORATION

**IT-14 INTERPRETATIONS OF TENDER DOCUMENT :**

Tenderers shall carefully examine the tender documents and fully inform themselves as to all the conditions and matters which may in any way effect the work or the cost thereof. Should a tenderer find discrepancies or omission from the specifications or other documents, or should be in doubt as to their meaning, he should at once address query to the Divisional Head provided for concerned authority as referred in the Tender Document in Clause GC-01 (Definitions and interpretations) of the (General Condition of Contract). Any resulting interpretation of the Tender documents will be issued to all Tenderers as an addenda corrigendum. Verbal clarification and / or information given by the SMC / Consulting Engineer shall not be binding on the Municipal Corporation.

**IT-15 ERRORS AND DISCREPANCIES IN TENDERS :**

In case of conflict between the figures and words in the rates, the rates expressed in words shall prevail and apply in such cases.

**IT-16 MODIFICATION OF DOCUMENTS :**

Modification of specifications and extension of the closing date of the tender, if required, will be made by an addendum. Copies of each addendum will be sent to all tenderers. These shall be Signed and shall form a part of tender. The tenderer shall not add to or amend the text of any of the documents except in so far as may be necessary to comply with any addenda.

**IT-17 ADDENDA**

Addenda form part of the contract documents & full consideration shall be given to all addenda in the preparation of tenders. Tenderers shall verify the number of addenda issued, if, any and acknowledge the receipt of all Addenda in the Tender. Failure to acknowledge may cause the Tender to be rejected.

A. The Engineer of the owner may issue Addenda to advise Tenderers of changed requirements. Such addenda may modify previously issued Addenda.

B. No Addendum may be issued after the time stated in Notice Inviting Tenders.

**IT-18 TAXES AND DUTIES ON MATERIAL :**

All charges on account of Octroi, terminal tax or Sales tax or other taxes for time being in force etc. and other duties on material obtain for the works from any source shall be borne by the Contractor. 'P' and 'C' form shall not be supplied by the Municipal Corporation.

**IT-19 EVALUATION OF TENDERS :**

As per IT (04), Experience of the Contractor shall be considered for Similar kind of works.

**IT-20 EVALUATION OF TIME REQUIRED FOR COMPLETION :**



The time required for completion of work shall be considered as indicated by the tenderer in the completion schedule attached with the tender. The completion period mentioned in this schedule is to be reckoned from 10<sup>th</sup> day from the date of work order to proceed. Total completion period is calendar months from 10<sup>th</sup> day from date of issue of work order and tenderer s should adhere to this delivery time.

**IT-21 POLICY FOR TENDER UNDER CONSIDERATION :**

Tenders shall be termed to be under consideration from the opening of the tender until such time an official announcement of award is made.

While tenders are under consideration, tenderer s and their representative or other interested parties are advised to refrain from connecting by any means Municipal Corporation or representatives on matters related to the tenders under study. The Engineer's representative if necessary will obtain clarification on tenders by requesting information from any or all the tenderer s either in writing or through personal contact, as may be necessary. The tenderers will not be permitted to change the substance of his tender after price submission. Non-compliance with this provision shall make the tender liable for rejection.

**IT-22 PRICES AND PAYMENTS :**

The tenderer must understand clearly that the price quoted are for the total works or the part of the total works quoted for and include all costs due to materials labour, equipment, supervisions, other services, royalties and Octroi etc. and to include all extras to cover the cost. No claim for additional payment beyond the prices quoted will be entertained and the tenderer will not be entitled subsequently to make any claim on any ground excepting for the condition laid down in GC-35 (Price Adjustment).

**IT-23 PAYMENT TERMS :**

The terms of payment are defined in the General Conditions of Contract. The Municipal Corporation shall not under any circumstances relax, their terms of payment and will not consider any alternative payment terms. Tenderer s should therefore in their own interest note this provision to avoid rejection of their tenders.

**IT-24 AWARD :**

Award of the Contract or the rejection of tenders will be made during the Tender validity period stated in the Notice Inviting Tenders.

- A. After all contract contingencies are satisfied and the Notice of Award is issued, the successful Tenderer shall execute the Contract Agreement within the time stated in the Notice Inviting Tenders and shall furnish the Bond as required herein. The Contract Agreement shall be executed in the form stipulated by the owner. A copy of the required form is included in the contract documents.
- B. If the Tenderer receiving the Notice of Award fails or refuses to execute the Contract Agreement within the stated time limit or fails or refuses to furnish the Bond as required herein, the SMC may annul his award and declare the tender security forfeited.
- C. A Corporation, Partnership firm or other consortium acting as the Tenderer and receiving the Award shall furnish evidence of its existence and evidence that the officer signing the Contract Agreement & Bonds for the Corporation, partnership firm or other consortium acting as the Tenderer is duly authorized to do so.

**IT-25 SIGNING OF CONTRACT :**

The successful tender shall be required to pay the security deposit and to execute the contract within 10 days of receipt of intimation to execute the contract, failing which the Municipal Corporation will be entitled to annul the award and forfeit the Earnest Money Deposit. The person to sign the contract document shall be person detailed in Article IT-12.

**IT-26 DISQUALIFICATION :**

A tender shall be disqualified and will not be taken for consideration if :-

- (a) The outer envelope does not show on the outside the reference of bid and thus get opened before the due date of opening (as per Article IT-10 i.e. Submission of Tender Document).
  - (b) The tender Security Deposit is not deposited in full and in the manner i.e. Earnest Money Deposit.
  - (c) The tender is in a language other than English or does not contain its English Translation in case of other language adopted for tender preparation.
  - (d) The tender documents are not signed by an authorised person.
  - (e) The general performance data for qualification not submitted fully.
  - (f) The tenderer does not agree to deposit security amount as specified (as per Article IT-25 i.e. Signing of Contract).
  - (g) The tenderer does not agree to payment terms defined as per Article IT-23 i.e. Payment Terms.)
  - (h) Conditional tender.
- A. Tenderer may further be disqualified if :



- (a) Price variation is proposed by the Tenderer on any principles other than provided in the Tender Documents.
- (b) Completion schedule offered is not consistent with the completion schedule defined and specified in tender documents.
- (c) The validity of tender is less than that mentioned in Article IT-11 i. e. Tender Validity Period.
- (d) Any of the page or pages of tender is/are removed or replaced.
- (e) All corrections or pasted slips are not initialed by tenderer.
- (f) Any erasure is made in the tender.

**IT-27 PERFORMANCE GUARANTEE (SECURITY DEPOSIT) :**

As a contract security the tenderer to whom the award is made shall furnish a performance guarantee (Security Deposit) for amount equal to Two percent (2%) of the contract price to guarantee the faithful performance completion and maintenance of the works of the contract in accordance with all the conditions and terms specified herein and to the satisfaction of the Engineer and ensuring the discharge of all obligations arising from the execution of contract, in one of the forms mentioned below.

(a) A Fixed Deposit Receipt (**S.D. Amount more than Rs.50,000/-**) of a Nationalised Bank or Government securities duly, located at Surat endorsed in favour of the Municipal Commissioner, Surat Municipal Corporation, Surat.

(b) By a demand draft of a Nationalised bank Acceptable to owner on the Surat Branch.

(C) By Bank Guarantee from the Nationalized/scheduled Bank

The performance guarantee shall be delivered to the Municipal Corporation within Ten (10) days of the notice of award.

Security deposit shall be paid in time and if it is paid after Ten(10) days from the date of preliminary work order then the penalty of 0.065 % per day of the amount of security deposit shall be recovered from the contractor while receiving the security deposit. On due performance and completion of the contract in all respects, the performance guarantee (security deposit) will be returned to the contractor after the defect liability period and on compliance of audit objections, if any. It is clarified that the amount of security deposit shall be collected on the basis of Contract Price and not on the basis of estimated amount put to tender. As initial Security Deposit Two percent (2%) of the tendered amount accepted by the competent authority shall have to be paid towards security deposit at the time of execution of agreement.

**Seven percent (7%) shall be deducted from running bills as retention money.**

**IT-28 STAMP DUTY :**

The successful tenderer shall have to enter into an agreement on a non-judicial stamp paper of Rs.4.25% of S.D. Amount, if S.D. Amount in FDR and otherwise as per the form of the agreement approved by the Municipal Corporation, Surat.

The agreement shall be executed on stamp paper worth Rs.4.25% of S.D. Amount.

The Surety shall be executed on stamp paper worth Rs.100/-.

**IT-29 BRAND NAMES :**

Specific references in the specifications to any materials by tender's name, or catalogue number shall be construed as establishing a standard or quality and performance and not as limiting competition and the tenderer in such cases, may at their option freely use any other product, provided that it ensures and equal or higher quality than the standard mentioned and meets Municipal Corporation approval.

**IT-30 NON-TRANSFERABLE :**

Tender documents are not transferable.

**IT-31 COST OF TENDERING :**

The owner will not defray expenses incurred by Tenderer s in tendering.

**IT-32 DEFECT OF TENDER :**

The Tender for the work shall remain open for a period of 120 calendar days from the date of receipt of the tenders for this work and that the tenderer shall not be allowed to withdraw or modify the offer on his own during the period. If any tenderer withdraws or makes any modifications or additions in the terms and conditions on his own, then the Municipal Corporation, shall without prejudice to any right or remedy, be at liberty to reject the tender and forfeit the earnest money in full.

**IT-33 CHANGE IN A QUANTITY :**

The Surat Municipal Corporation reserves the right to waive any informality in any tender and to reject one or all tenders without assigning any reasons for such rejections and also to vary to quantities of items or group as



specified in the Schedule of price as may be necessary. Claim what so ever by the contractor on the basis of variation of quantities shall not be entertained.

**IT-34 NEW EQUIPMENT AND MATERIAL ;**

All materials, equipment and spare parts thereof shall be new, unused and originally coming from manufacturer's plant to the Corporation. The rebuilt or overhauled equipment/materials will not be allowed to be used on work.

**IT-35 RIGHTS RESERVED ;**

The SMC reserves the right to reject any or all tenders, to waive any informality or irregularity in any tender without assigning any reasons. The SMC further reserves the right to withhold issuance of the notice to proceed, after execution of the contract agreement, for the period of time stated in the notice inviting tenders and no additional payment will be made to the successful tenderer on account of such withholding. The SMC is not obliged to give reasons for any such action.

**IT-36** Municipal Commissioner reserves the right to reduce the scope of work and split the tender in two or more parts without assigning any reason even after the award of contract.

**IT-37** No mobilization advance or advance on machinery will be given.

**IT-38** The scope of work is clearly mentioned in the tender documents. The contractor shall have to carry out the work in accordance with the details specifications. No conditions will be accepted. The conditional tender will be liable to be rejected.

**IT-39** The surplus excavated earth, after back-filling the trenches shall have to be removed from the site as directed. After compaction and consolidation, if any short fall of earth is found then contractor has to bring the same to the required quantity in order to meet shortfall at his own cost. More over, if any settlement of road after reinstatement is bserved during the defect liability period of the work. Contractor shall be fully responsible for the defective work and patches/ depression / settlement shall be repaired with quarry spoil or metal at contractor's own cost. If contractor fails to repair the patches / depression / settlement in time, corporation will repair it at all risk and cost of contractor.

Surplus earth shall not be disposed off in a way that leads to nuisance to the public or SMC.

EXECUTIVE ENGINEER,  
SOUTH ZONE (UDHNA)  
SURAT MUNICIPAL CORPORATION ,

SIGNATURE OF THE CONTRACTOR.



Rs100/- Stamp
---------------

**FORMAT FOR BANK GAURANTEE**

- [1] In consideration of the Terms and Conditions of an "Agreement made between Commissioner, Surat Municipal Corporation, Surat (herein after called" Surat Municipal Corporation") and..... (Contractor) (hereinafter called "Contractor" for the work of .....  
..... (Name of work) for the ..... deposit for the due fulfillment by the contractor of the terms and conditions contained in the said agreement, We Bank of ..... (hereinafter referred to as the Bank) at the request of ..... (Name of Contractor) do hereby undertake to pay the Surat Municipal Corporation an Amount not exceeding Rs..... (i.e. 50% of Total..... Deposit Amount) against any loss or damage caused to or suffered by Surat Municipal Corporation by reason of any breach of any term or condition contained in the said agreement by the said Contractor.
  
- [2] We Bank of..... do hereby undertake to pay the amount due and payable under this Guarantee without any demur merely on a demand from the Surat Municipal Corporation stating that the amount claimed in due by way of loss of damage caused to or would be caused to or suffered by the Surat Municipal Corporation by the reason of breach by the said contractor of any of the terms and conditions in the said agreement of by reason of the contractor failure to perform the said agreement. Any such demand made on the Bank shall be conclusive as regards the amount due and payable by the Bank under this guarantee shall be restricted to an amount not exceeding Rs..... (50% of Total of Amount of..... Deposit).
  
- [3] We undertake to pay the Surat Municipal Corporation any money so demanded notwithstanding dispute or disputes raised by the contractor. In any suit of proceeding pending before any Court or Tribunal relating thereto our liability under this present being absolute and unequivocal. The payment so made by under this bond shall be a valid discharge of our liability for payment there under and the contractor shall have no claim against us for making such payment.
  
- [4] We Bank of ....., ..... further agree that the guarantee herein contained shall remain in full force and effecting during the period that would be taken for the performance of the said agreement and that under or by virtue of said agreement have been fully paid and its clime satisfied or discharged or till Commissioner, Surat Municipal Corporation, Surat clarified that the terms and conditions of the said agreement have been fully and properly carried out by the said contractor and accordingly discharge this guarantee. Unless a demand or claim under this agreement is made on us in writing on or before (dt.) ..... we shall be discharged from all liability under this Guarantee thereafter.
  
- [5] We Bank of ..... further agree with the Surat Municipal Corporation that the Surat Municipal Corporation shall have the fullest liberty without our consent and without in any manner our obligations hereunder to vary and of the terms and conditions of the said agreement or to extend the time of performance by the said contractor from time to time or to postpone for any time or time to time any of the power exercisable by the Surat Municipal Corporation against the said contractor and to Forbes or enforce any of the terms and conditions relating to the said agreement and we shall not be relieved from our liability by reason of any variation or extension being granted to



the said contractor or for any béarnaise, act or omission of the part of the Surat Municipal Corporation or any indulgence by the Surat Municipal Corporation to the said contractor or by any such matter or thing whatsoever which under the law relating to sureties would but for his provision have of a relieving us.

[6] This guarantee will not be discharged due to the change in the constitution of the Bank or the Contractor.

[7] We Bank of ..... lastly under take not to revoke during its urgency except with the previous consent of the Surat Municipal Corporation in writing.

NOT WITH STANDING ANYTHING CONTAINED HERE IN :

[1] Our liability under this bank guarantee is restricted to Rs. .... (50 % Amount of ..... Deposit)

[2] This bank guarantee is valid up to .....

[3] Our liability to make payment shall arise and we are liable to pay the guarantee amount or any part there of under this guarantee, only if served upon us a written claim a demand in terms of the guarantee on or before dt. ....

[4] In written of bank has executed this present the day and year first written.  
Date the ....., Month ....., Year ..... for ..... (Bank name).

**Seal, stamp and signature  
of Bank's authorized Signatory**



SURAT MUNICIPAL CORPORATION  
PERCENTAGE RATE TENDER & CONTRACT FOR WORKS

## GENERAL RULES AND DIRECTIONS FOR THE GUIDANCE OF CONTRACTORS :-

- (1) All work proposed to be executed by contract shall be notified in a form of invitation to tender pasted on a board hung up in the office of the Engineer & signed by the Engineer.  

This form will state the work to be carried out as well as the date/or submitting and opening tenders and the time allowed for carrying out work, also the amount of earnest money to be deposited with the tender and the amount of the Security Deposit to be paid by the successful tenderer and the percentage, if any, to be deducted from bills. It will also state whether a refund of quarry fees, royalties, octroi dues and ground rent will be granted. Copies of the specifications, designs and drawings and estimated rates and any other documents required in connection with the work which shall be signed by the Engineer-in-charge for the purpose of identification shall also be open for inspection by contractors at the office of the Engineer-in-charge during office hours.

Where the work are proposed to be executed according to the specifications recommended by a contractor and approved by a competent authority on behalf of the corporation, such specifications with designs and drawings shall form part of the accepted tender.
- (2) In the event of the tender being submitted by a firm, it must be signed separately by each partner thereof, or in the event of the absence of any partner, it shall be signed on his behalf by a person holding a power of attorney authorizing him to do so.
- (3) Receipts for payments made on account of any work, when executed by a firm, shall also be signed by all the partners, except where the contractor are described in their tender as a firm, in which case the receipts shall be signed in the name of the firm by one of the partners or by some other persons having authority to give effectual receipts for the firm.
- (4) Any persons, who submit tender shall fill up the usual printed form including the 'Column' total according to estimated quantities, stating at what rate he is willing to undertake the each item of the works, Tenders which proposal any alterations in the work specified in the said form of invitation to tender or in the time allowed for carrying out the work or which contain any other conditions of any short, will liable to be rejection. No. single tender include more than one will liable to be rejection. No. single tender include more than one work but contractors who wishes to tender for each. Tender shall have (to which they refer) written outside the envelope.
- (5) The Commissioner or his duly authorized assistant shall open tender in the presence of any intending contractors who have submitted tender or their representatives who may be present at the time. In the event of a tender being accepted, the contractor shall there upon for the purpose of identification, sign the copies of the specifications and other documents mentioned in this tender. In the event of the tender being rejected, the divisional officer shall authorized the accountant to refund the amount of earnest money deposited to the contractor making the tender on his giving a receipt for the returned of the money.
- (6) The officer competent to dispose of the tender shall have the right of rejecting all or any of the tenders.
- (7) No receipts for any payment alleged to have been made by a contractor in regard to any matter to this tender shall be valid and binding on corporation unless it is signed by the Engineer-in-charge.
- (8) The memorandum of work to be tendered for and the schedule of materials to be supplied by the concern department and their rates shall be filled in and completed by the officer of the Engineer-in-charge before the tender form is issued. If a form issued an intending tenderer has not been so filled in and completed, he shall request the said officer to have this done before he completes and delivers his tender.
- (9) All works shall be measured net by standard measure and according to the rules and customs of the Public Works Department without reference to any local custom.
- (10) Under no circumstances shall any contractor be entitled to claim enhanced rates for any items in this contract.
- (11) Every contractor shall unless excepted in writing by the Additional City Engineer concerned, produced along with the tender, a solvency certificate of his financial stability from the Collector of the District within which he resides or a Bankers certificates. If he fails to produce such a certificate, his tender may not be considered.
- (12) All corrections and additions or pasted slips should be initiated.
- (13) The measurement of work will be taken according to the usual method in use in the public works department and no proposals to adopt alternative methods will be accepted. The Engineer-in-charge decision as to what is "the usual method in use in the public works department" will be final.



- (14) The Insurance Company's bond will not be accepted against the Security Deposit.
- (15) The Contractor will have to construct a shed for storing control and valuable materials issued to him under Schedule-'A' of the agreement at work site having double locking arrangement. The materials will then be taken for use in the presence of the department person. No materials will be allowed to be removed from the site of work except with the written permission from Engineer- in-charge.
- (17) No foreign exchange will be released by the Corporation for the purpose of plant and machines required for the execution of the work contracted for.
- (18) Controlled materials (Essentiality certificate)
  - (i) As regard controlled materials the Corporation will help to arrange for the permit as far as possible and help the contractor in securing for the permit as far as possible and help the contractor in securing the same. All incidental charges met with in procuring these materials shall be borne by the contractor himself. Though the Corporation will help to arrange for the permit as far as possible and help the contractor in obtaining the materials it shall not accept any responsibility for any delay or loss on account of delay caused to the contractor while obtaining the same.
  - (ii) The contractor shall submit to Engineer-in-charge on Close of every calender months, the monthly returns in the prescribed forms as to the receipt and actual use of the controlled materials during the month.
  - (iii) The contractor shall permit the Engineer- in- charge or his representatives to inspect the stock of the controlled materials stored by him at any time, whenever the Engineer-in- charge or his representatives so desired (s).
- (19) The tender for work shall remain open for a period of 120 days from the date of opening of the price bid for this works and that the tenderer shall not be allowed to withdraws or modify the offer on his own during this period. If any tenderer withdraws or makes any modifications or addition/s in the terms and conditions of his tender, not acceptable to the corporation them the corporation shall without prejudice to any right or remedy be at liberty in full the said earnest money absolutely (in figures as well as in words). This Blank Space should be filled in while preparing the draft tender papers.
- (20) The contractor shall employ only such labourer who shall produce a valid certificate of having been vaccinated against small pox within a period of last 3 years.
- (21) Tenderer should submit True Copy of the Certificate of Registration along-with the tender without which the tender will not be considered.
- (22) The contractor shall have to give in writing the date completion of the work within a fortnight from the date of work completed by him. Otherwise the date noted on the record by the department shall be reawakened as final and no excuse or representation in that behalf shall be entertained at later date.
- (23) "What ever sales tax is levied by the Government on works contract and if paid by the contractor in the first instance, shall be refunded to the concerned contractor by Corporation.

EXECUTIVE ENGINEER,  
SOUTH ZONE (UDHNA),  
SURAT MUNICIPAL CORPORATION

SIGNATURE OF CONTRACTOR



**GENERAL CONDITION OF CONTRACT****SECTION-I****GC-01 DEFINITIONS AND INTERPRETATIONS :**

1.0 In the contract documents, as herein defined the following words and expression used shall, unless, repugnant to the subject or context thereof, have the following meanings assigned to them.

1.1 The "Owner/Municipal Corporation, Surat represented by Municipal Commissioner/Add.City Engineer, any officer authorised by the Municipal Corporation.

1.2 The "Contractor" shall mean the person or the persons, firm or company whose tender has been accepted by the owner and includes his legal representative successors and permitted assigns.

1.3 The "Engineer-in-charge" shall mean the person designated as such by the owner from time to time and shall include those who are expressly authorised by the Municipal Corporation to act for and on its behalf for the operation of this contract.

1.4 "Engineer - in - charge's Representative" shall mean any Engineer or Asstt. to the Engineer-in-charge designated from time to time by the Engineer-in-charge to perform duties set forth in the Tender documents whose authority shall be notified in writing to the Contractor by the Engineer-in-charge.

1.5 "Tender" The offer or proposal of the Tenderer submitted in the prescribed form setting forth the prices for the work to be performed, and the details thereof.

1.6 "Contract Price shall mean total money payable to the Contractor under the contract documents.

1.7 "Addenda" shall mean the written or graphic notices prior to submission of tender which modify or interpret the contract documents.

1.8 "Contract Time" - The number of consecutive calendar months for the completion of work as stated in the executed contract agreement.

1.9 "Contract" shall mean agreements between the parties for the execution of works including therein all contract documents.

1.10 "Tender document" shall mean Designs, Drawings, specifications, agreed variations, if any, and such other documents constituting the tender and acceptance thereof.

1.11 "The Sub-Contractor" means any person, firm or company (other than the contractor) to whom any part of the work has been entrusted by the Contractor with the written consent of the Engineer-in-charge and the legal personnel representative, successors and permitted assignees of such person, firm or company.

1.12 "The Specifications" shall mean all directions, the various technical specifications provisions and requirements attached to the contract which pertain to the method and manner of performing the work to the quality of the work and the materials to be furnished under the contract for the work and any order(s) or instruction (a) thereunder. It shall also mean the latest Indian Standards Institution Specifications for or relative to the particular work or part thereof, so far as they are not contrary to the Tender specifications or I.S.I. specifications, and in absence of any tender specifications, the specifications of any other country applied in India as a matter of Standard Engineering practice and approved in writing by the Engineer-in-charge with or without modifications.

1.13 The "Drawing" shall include maps, plans, tracings or prints thereof with any modifications approved in writing by the Engineer-in-charge and such other drawings, as may, from time to time, be furnished or approved in writing by the Engineer-in-charge in connection with the work.

1.14 The "Work" shall mean the works to be executed in accordance with the context or the part thereof as the case may be and shall include extra, additional altered or substituted works as required for the purpose of the Contract. It shall mean the totality of the work by expression or implication envisaged in the contract and shall include all material, equipment and labour required for or relative or incidental to or in connection with the commencement, performance and completion of any work and/or for incorporation in the work.

1.15 The "Permanent work" means works which will be incorporation in and form part of the work to be handed over to the owner by the contractor on completion of the contract.

1.16 The "Temporary Work" shall mean all temporary works of every kind required in or about the execution, completion and maintenance of the work.

1.17 "Site shall mean the land and other place on, under, on or through which the work is to be carried out and any other lands or places provided by the Municipal Corporation for the purpose of the Contract together with any other places designated in the Contract as forming part of the site.

1.18 "The Construction Equipment" means all appliance/equipments of whatever nature required in or for execution, completion or maintenance of work or temporary works (as hereinafter defined) but does not include materials or other things intended to form or forming part of the permanent work.

1.19 "Notice in Writing or Written Notice" means a notice written, typed or printed form delivered personally or sent by Registered post to the latest known private of business address at Registered Office of the Contractor.

1.20 The "Alteration/Variation order" means an order given in writing by the Engineer-in-charge to effect additions to or deletion from and alterations in the work.

1.21 "Final Test Certificate" shall mean the final test Certificate issued by the owner within the provisions of the Contract.



- 1.22 The "Completion Certificate" shall mean a certificate to be issued by the Engineer-in-charge when the work has been completed to his satisfaction.
- 1.23 The "Final Certificate" shall mean the final certificate issued by the Engineer-in-charge after the work is finally accepted by the owner.
- 1.24 "Defect Liability Period" shall mean the specified period between the issue of completion Certificate and the final certificate as specified in the tender.
- 1.25 "Approved" shall mean approved in writing including subsequent modification in writing of previous verbal approval and "Approval" means approved in writing including as aforesaid.
- 1.26 "Letter of Acceptance" shall mean an intimated by a letter to tenderer that the tender has been accepted in accordance with provisions contained therein.
- 1.27 "Order" and "Instruction" shall respectively mean any written order or instruction given by the Engineer-in-charge within the scope of his powers in terms of the Contract.
- 1.28 "Running Account Bill" shall mean a Bill for the payment of "On Account" money to the contractor during the progress of work on the basis of work done and the non-perishable materials to be incorporated in the work supplied by the Contractor.
- 1.29 "Security Deposit" shall mean the deposit to be held by the owner as security for the due performance of contractual obligations.
- 1.30 "The appointing authority" for the purpose of Arbitration shall be the Municipal Commissioner, Surat Municipal Corporation, Surat.
- 1.31 Retention Money shall mean the money retained from R.A. Bill for due completion of 'NET WORK'.
- 1.32 Unless otherwise specifically stated, the masculine gender shall include the feminine and natural genders and vice-versa and the singular shall include the plural and vice-versa.

#### GC-02 LOCATION OF SITE AND ACCESSIBILITY :

The site of works is within the limits of Surat Municipal Corporation. It is served by all weather roads and Western Railway Broad Gauge line, Government Irrigation Canal Crossign. The intending Tenderer should inspect the site and make himself familiar with site conditions and available communication facilities. Non availability of access/roads shall in no case be the cause to condon any delay in the execution of the work or be the cause for any claims or extra compensation.

#### GC-03 SCOPE OF WORK :

The scope of work is defined broadly in the special conditions of Contract and specifications. The Contractor shall provide all necessary materials equipment and labour etc. for the execution and of the work till completion. All materials that go with the work shall be approved by the Engineer-in-charge prior to procurement and use. Owner at his discretion may endeavour to provide water to the Contractor at the owner's source of supply at one point at the rate charged for such works.

The contractor shall make his own arrangement for the distribution pipe net works from the source of supply after getting prior permission for the same from the Engineer-in-charge. Supply of water shall not be free and the necessary charges as fixed by the Local Body shall have to be paid by the contractor.

However, owner does not guarantee the supply of water and this does not relieve the contractor of his responsibility in making his own arrangements and for the timely completion of the work as stipulated.

#### POWER SUPPLY :

The Contractor shall have to make his own arrangement for power supply.

#### LAND FOR CONTRACTOR'S FIELD OFFICE, GODOWN & WORKSHOP:

Owner will not be a position to provide land required for Contractors shall have to make his own arrangement for the same. No land will be provided by S.M..C. to the contractor for constructing his labour and supervisory comp and other service facilities.

#### GC-04 RULLING LANGUAGE :

The language according to which the contractor shall be constructed and interpreted shall be English. All entries in the contract documents and all correspon-dence between the contractor and the Municipal Corporation or the Engineer shall be in English. All dimensions for the materials shall be given in metric units only.

#### GC-05 INTERPRETATION OF CONTRACT DOCUMENT :

1. The provisions of the General Conditions of Contract and special conditions of contract shall prevail over those of any other documents of the contract unless specifically provided otherwise. Should there be any discrepancy, inconsistency error or omission in the several documents forming the contract, the matter may be referred to the Engineer-in-charge for his instructions and decision. The Engineer-in-charge's decision in such case shall be final and binding to the contractor.



2. Works shown upon the drawings but not described in the specifications of described in the specific specifications without showing on the drawings shall be taken as described in the specifications and shown on the drawings.
  3. The heading and the marginal notes to the clauses of those general conditions of contract or to the specifications or to any other part of tender documents are solely for the purpose of giving a concise indication and not a summary of contents thereof or be used in the interpretation or construction thereof of the contract.
  4. Unless otherwise stated specifically, in this contract documents the singular shall include the plural and vice versa wherever the context so requires. Works implementing persons shall include relevant corporated companies/ registered associations / body of individual / firm of partnership.
  5. Notwithstanding the sub-divisions of the documents into separate sections and volumes every part of each shall be supplementary to and complementary of every other part and shall be read with and into the context so far as it may be practicable to do so.
  6. Where any portion of the General Conditions of contract is repugnant to or a variance with any provisions of the special conditions of contract, then, unless a different intention appears, the provisions of the special conditions of contract shall be deemed to override the provisions of General conditions of Contract and shall to the extent of such repugnancy or variance prevail.
  7. The materials, Design and Workmanship shall satisfy the relevant I.S.S. and Codes referred to. If Additional requirements are shown in the specifications, the same shall be satisfied over and above I.S.S. and Codes.
  8. If the specification mention that the contract shall perform certain work or provide certain facilities, it will mean that the contractor shall do so at his own cost.
  9. The correctness of the details given in the tender documents is not guaranteed. The contractor shall independently obtain all necessary information for making the tender. The contractor shall be deemed to have examined the Contract Documents, to have generally obtained his own information in all matters that might affect the carrying out of the work or the Tenderer rates. Any error in description of quantity or commission there from shall not vitiate the contract or release the contractor from executing the work comprised in the contract according to the Drawings and specifications at the tendered rates. He is deemed to have known the scope, nature and magnitude of the work and the requirements of materials and labour involved and as to what all works he has to complete in accordance with the contract what-soever be the defects, omissions, or errors that may be found in the contract documents. The contractor shall be deemed to have visited the site and the surroundings, to have satisfied himself to the nature of all existing structures, if any, and also as to the nature and the conditions of railways, roads, bridges and culverts, means of transport and communications, whether by land, air or water and as to possible interceptions thereto and the access and agrees from the site, to have made inquiries, examined and satisfied himself as to the sites for obtaining sand, stones, bricks and other materials, the sites for disposal of surplus materials, the available accommodation as to whatever required, the depicts and such other buildings as may be necessary for executing and completing the work, to have local independent inquiries as to the subsoil, subsoil water and variation thereof, storms, prevailing winds, climatic conditions and all other similar matters effecting the work. He is deemed to have acquainted himself as to his liability for payment of Government taxes, custom duty and other charges.
- Any neglect or failure on the part of the contractor in obtaining necessary and reliable information upon the forgoing or any other matters affecting the contract shall not relieve him from any risks or liabilities or the entire responsibility from completion of the work at the tendered rates and time in strict accordance with the contract documents.
- No verbal agreement or inference from conversation with any officer or employee of the owner either before or after the execution of the Contract Agreement shall in any way effect or modify any of the terms of obligations herein contained.

**GC-06 CONTRACTOR TO UNDERSTAND HIMSELF FULLY ;**

The contractor by tendering shall be deemed to have satisfied himself, as to consideration and circumstances affecting the tender price, as to the possibility of executing the works as shown and described in the contract and to have fixed his prices according to his own view on these matters and to have understand that no additional allowances except as otherwise expressly provided, will after words be made beyond the contract price. The contractor shall be responsible for any misunderstanding or incorrect information given in writing by the Engineer.

**GC-07 ERROR IN SUBMISSION ;**

The contractor shall be responsible for any errors or omissions in the particulars supplied by him. Whether such particulars have been approved by the Engineer or not, provided that such discrepancies, errors or omissions be not due to inaccurate information or particular furnished in writing to the Contractor by the Municipal Corporation or the Engineer.

**GC-08 SUFFICIENCY OF TENDER :**

The Contractor shall be deemed to have satisfied himself before tendering as to the correctness of the tender rates which rates shall, except as or other wise provided for, cover all the Contractor's liabilities and obligation set forth or implied in the contract for the proper execution of work for compliance with requirements of Article GC-19 thereof.

**GC-09 DISCREPANCIES :**

The drawings and specifications are to be considered as mutually explanatory of each other, detailed drawings being followed in preference to small scale drawings and figures dimension in preference to scale and special conditions in preference to general conditions. Special direction or dimensions given in the specifications shall supersede all else. Should any discrepancies however, appear or should any misunderstanding arise as to the meaning and intent of the said specifications or drawings, or as to the dimensions or the quality of the materials or the due and proper execution of the works, or as to the measurement or quality and valuation of the works executed under this contract or as extra there upon the same shall be explained by the Engineer-in-charge and his explanation shall subject to the final decision of the Additional City Engineer, in case reference be made to him, be binding upon the contractor shall execute the work according to such explanation (subject to aforesaid) and without addition to or deduction from the contract and shall also do all such works and things necessary for the proper completion of the works as implied by the Drawings and specifications, even though such works and things are not specially shown and described in said specifications. In cases where not particular specifications are given for any article to be used under the contract, relevant specifications of the Indian Standard Institution shall apply.

**GC-10 PERFORMANCE GUARANTEE : (Security Deposit)**

1. A sum of 2.0% of the accepted value of the tender contract price shall be deposited by the tenderer (hereinafter called. The Contractor while tender is accepted) as Security deposit with the S.M.C. for the faithful performance, completion of the works in accordance with the contract documents and to the satisfaction of the Engineer and assuring the payment of all obligations arising from the execution of the contract.

This shall be deposited initially at 2.0% of the value of the contract within fifteen days of the receipt by him or the notification of acceptance of tender and at least three (3) days before the contract agreement is executed in the forms mentioned below :

(a) In cash or by a demand draft of a Schedule Bank acceptance to owner on the Surat Branch.

(b) A fixed deposit receipt of a Scheduled Bank or Government Securities located at Surat duly endorsed in favour of the Municipal Commissioner, Surat Municipal Corporation, Surat.

(c) By Bank Guarantee from the Nationalized/scheduled Bank

If the value of the work as per actual execution exceeds the accepted value of tender because of allotment of further work further recoveries towards security deposit shall be effected at four percent (4%) of R.A.Bill to make up the total amount of security deposit equal to two point five percent (2.0%) of the revised value of contract. Alternatively the Contractor may at his option deposit the full amount of security deposit as per the revised value of the contract within fifteen days of receipt by him on the notification accepting the tender in the form as aforesaid.

2. If the Contractor, sub-contractor or their employees shall break, deface or destroy any property belonging to the owner or other agency during the execution of the contract, the same shall be made good by the contractor at his own expenses and in default thereof, the Engineer-in-charge may cause the same to be made good by other agencies and recover expenses from the Contractor (for which the certificate of the Engineer-in-charge shall be final). These expenses can be recovered from the security deposit if recover from other sources is not possible. The amount so reduced in security deposit will be made good by deduction from the next R.A.Bill of the Contractor.

3. All compensation or other sums of money payable by the contractor to the owner under terms of this contract may be deducted from or paid by the sale of sufficient part of his security deposit or from any sums which may be due or become due to the contractor by the owner on any account whatsoever and in the event this Security deposit being reduced by reasons of any such deductions or sale of security deposit or part thereof as aforesaid, the Contractor shall within Ten days thereafter make good the in cash, bank drafts or Government Securities endorsed as aforesaid. No interest shall be payable by the owner for sum deposited as security deposit.

4. The security deposit shall be extendable upto the date as decided by Engineer in accordance with Requirement of contractual obligations under the contract.

5. The security deposit less any amounts due shall be returned to the contractor without any interest after the defects liability period is over and subject to the Engineer-in-charge certifying that no liability attaches to the contractor.

6. The performance guarantee shall be delivered to the Municipal Corporation within Ten (10) days of the notice of award. Security Deposit should be paid in time and if it is paid after Ten days from the date of work order then the penalty of 0.065% per day of the amount of security deposit should be recovered from the Contractor while receiving the security deposit. The performance guarantee will be returned to the Contractor without any interest after the defect liability period is over and on compliance of audit objections, if any. It is clarified that the amount of security deposit shall be collected on the basis of Contract Price and not on the basis of estimated amount put to tender. Two percent (2.0%) of the tendered amount accepted by the competent authority shall have to be paid towards security deposit at the time of execution of agreement.

**GC-11 INSPECTION OF WORK :**

1. The Engineer in charge will have full power and authority to inspect the work at any time wherever in progress either on the site or at the contractor's any other manufacturers workshops or factories wherever situated and the contractor shall afford for Engineer-in-charge every facility and assistance to carry out such inspection. Contractor or his authorised representative shall, at all time during the usual working hours and all other times when so notified,





remain present to receive orders and instructions, orders given to Contractor's representative shall be considered to have the same force as if they had been given to the contractor himself. Contractor shall give not less than 7 days notice in writing to the Engineer-in-charge before covering up or otherwise placing beyond reach of inspection and measuring any work in order that the same may be inspected and measured. In the event of breach of the above, the same shall be recovered at Contractor's expenses for carrying out such inspection or measurement.

2. No material shall be despatched from contract store on site of work before obtaining approval in writing of the Engineer-in-charge, Contractor shall provide at all time during the progress of work and maintenance period proper means of access with ladders, gangways, etc. and the necessary attendance to move and adopt as directed for inspection or measurement of work by Engineer-in-charge.

#### GC-12 DEFECT LIABILITY :

1. Contractor shall guarantee the work for a period of 12 months from the date of actual completion of work as per completion certificate. Any damage or defect that may arise or that may remain undiscovered at the time of issue of completion certificate connected in any way with the equipment or materials supplied by him or in the workmanship be rectified or replaced by contractor at his own expenses as desired by Engineer-in-charge or in default may cause the same to be made good by other agency and deduct expenses of which the certificate of Engineer-in-charge shall be final from any sums that may then or any time thereafter become due to contractor of sale thereof or of a sufficient portion thereof.

2. From the commencement to completion of work contractor shall take full responsibility for the case of the work including all temporary works and in case any damage, loss or injury shall happen to work or any part thereof or to any temporary works from any cause whatsoever and shall at his own cost repair and make good the same so that at completion work shall be in good order and in conformity in every respect with the requirements of contract and as per the instructions of the Engineer-in-charge.

3. If at any time before the work is taken over, the Engineer-in-charge shall -

(a) Decide that any work done or materials used by the contractor are defective or not in accordance with contract or that work of any portion thereof is defective or do not fulfill the requirements of contract (all such materials being hereinafter called defects in this clause and (b) as soon as reasonably practicable given to contractor notice in writing of the said defect specifying particulars of the defects alleged to exist or to have occurred, then contractor shall at his own expenses and with all speed make good the defects so specified.

(b) In case contractor fails to do so, owner may take at the cost of the contractor, such steps as may in all circumstances, be reasonable to make good such defects. The expenditure so incurred by S.M.C. will be recovered from the amount due to contractor. The decision of Engineer-in-charge with regard to the amount to be recovered from contractor will be final and binding on the contractor.

#### GC-13 POWER OF ENGINEER TO GIVE FURTHER INSTRUCTIONS :

The Engineer shall have the power and authority from time to time and at all times to give further instructions and directions as may appear to him necessary or proper for the guidance of contractor and the works and efficient execution of the works according to the terms of the specifications, and the contractor shall receive, execute, obey and be bound by the same, according to the true intent and meaning thereof, as fully and effectually as though the same had accompanied or had been mentioned or referred to in the specifications. No work which radically changes the original nature of the contract shall be ordered by the Engineer and in the event of any deviation being ordered, which in the opinion of the contractor changes the original nature of the contract, the contractor shall nevertheless carry it out and any disagreement as to the nature of the work & the rate to be paid thereof shall be resolved. The time of completion of works, in the event of any deviations, resulting in additional cost over the contract sum being ordered, then be extended or reduced reasonable by the Engineer. The Engineer's decision in the case shall be final and binding.

#### GC-14 PROGRAMME :

The time allowed for execution of works shall be essence of the contract. The contract period shall commence from date of Notice of intimation to proceed. The tenderer at the time of submitting his tender shall indicate the construction or pipeline schedule, the month-wise programme required for the execution of the works and shall confirm the same within fourteen (14) days of the acceptance of his Tender. The contractor shall provide to the Engineer-in-charge a detailed programme of time schedule for execution of the works in accordance with the specifications & the completion date. The entire programme to be finalised by the Contractor, has to confirm to the execution period mentioned along with the Bill of Quantities in the Tender Documents. The Engineer upon scrutiny of such submitted programme by contractor, shall examine suitability of it to the requirement of contract and suggest modifications, if found necessary.

#### GC-15 SUBLETTING OF WORKS :

No part of the contract nor any share or interest thereon shall in any manner or degree be transferred, assigned or sublet by the contractor directly or indirectly to any firm or Corporation whatsoever except as provided for in the succeeding subclause without the consent in writing of the owner.

#### GC-16 SUB-CONTRACTORS FOR TEMPORARY WORKS ETC. :



The owner may give written consent to sub-contractors for execution of any part of the work at the site being entered upon by the contractors provided each individual contractor is submitted to the Engineer-in-charge before being entered into and in approved by him. List of Sub-Contractors is to be supplied. Not with standing any subletting with such approval as aforesaid and not with standing the Engineer-in-charge shall have received copies of any sub-contractors, the contractors shall be and shall remain solely responsible for the quality and proper expenditures and execution of the works and the performance of all the conditions of contract in all respects as if such submitting or sub-contracting had not taken place and as if such work had done directly by the Contractor.

**GC-17 TIME FOR COMPLETION:**

1. The work covered under this contract shall be commenced from the date of contract is served with a notice to proceed with the work and shall be completed before the date as mentioned in the time schedule of work. The time is the essence of the contract and unless the same is extended as mentioned in clause No. GC-18 (Extension of time) the contractor will be penalised for the delay.

2. The general time schedule for work is given in the tender document. Contractor shall prepare a detailed weekly or monthly programme of work in consultation with Engineer-in-charge soon after the agreement and the work shall be strictly executed accordingly. The time for as construction of road given includes, the time required for testing, rectification if any, retesting and completion in all respects to the entire satisfaction of the Engineer-in-charge.

**GC-18 EXTENSION OF TIME :**

Time shall be considered as the essence of the contract. If however, the failure of the Contractor to complete the work as per the stipulated dates referred to above arises from delays on the part of Municipal Corporation in supplying the materials of equipment it has undertaken to supply under the contract or from delays in handing over sites or from increase in the quantity of work to be done under the contract, or force Majeure an appropriate extension of time will be given. The Contractor shall request such extension within one month of the cause of such delay and in any case before expiry of the contract period.

**GC-19 CONTRACT AGREEMENT :**

The successful tenderer shall when called upon to do so, enter into and execute the Contract Agreement within (10) Ten days of the Notice of Award, in the form shown in tender documents with such modifications as may be necessary in the opinion of the Municipal Commissioner. It should be incumbent on the contractor to pay the stamp duty and the legal charges for the completion of the contract agreement.

**GC-20A. PENALTY FOR DELAY :**

If the contractor fails to complete the work within the stipulated completion date for the work or he shall pay liquidated damages at one tenth of Two percent of contract value per day of delay in completion and handing over the work or part thereof as the case may be to the Municipal Commissioner. The amount of liquidated damages shall, however, be subjected to a maximum of ten (10) percent of the contract value. Delays in excess of one hundred days will be a cause for termination of the contract and forfeiture of all security for performance.

**B.BAR CHART:**

The successful tenderer shall have to submit the progress bar-chart within fifteen days after the contract, and the contractor should work as per the approved bar-chart, failing which the contractor shall have to pay the compensation for delay as per the decision of Municipal Commissioner.

**GC-21 FORFEITURE OF SECURITY DEPOSIT :**

Whenever any claim arises against the contractor for the payment of a sum of money out of or under the contract, the owner shall be entitled to recover such sum by appropriating in part or whole, the security deposit of the contractor. In case the Security deposit is insufficient the balance recoverable shall be deducted from any sum then due or which at any time thereafter may become due to the contractor shall pay to the owner on demand may balance remaining due.

**GC-22 ACTION OF FORFEITURE OF SECURITY DEPOSIT :**

In any case in which under any clause or clauses of the contract, the contractor shall have forfeited the whole of his Security deposit or have committed a breach of any of the terms contained in this contract, the owner shall have power to adopt any of the following courses as he may deem best suited to his interest -

(a) To rescind the contract (of which rescission notice in writing to the contractor under the hand of the owner shall be conclusive evidence) in which case, the security deposit of the contractor shall stand forfeited and be absolutely at the disposal of the owner.

(b) To employ labour and to supply materials to carry out the balance work debiting contractor with the cost of labour employed and the cost of materials supplied for which a certificate of the Engineer-in-charge shall be final and conclusive against the contractor and 10% costs on above to cover all departmental charges and crediting him with the value of work done at the same rates as if it has been carried out by the contractor under the terms of his contract.



The certificate of Engineer-in-charge as to the value of the work done shall be final and conclusive against the contractor.

(c) To measure up the work of the contractor and to take such part hereof as shall be unexecuted out of his hand to give it to another contractor to complete. In this case the excess expenditure incurred than what whole have been paid to the original contractor, if the would work had been executed by him, shall be earnest and paid by the original contractor and shall be deducted from any money due to him by the owner under the contract or otherwise and for the excess expenditure, the certificate of the Engineer-in-charge shall be final and conclusive.

In the event any of the above course being adopted by the owner, the contractor shall have no claim to compensation for any loss sustained by him by reason of his having purchased or procured any materials or entered into any agreement so or made by advance on account of or with a view to the execution of the work of the performance of the contract. In such case the contractor shall not be entitled to recover or be paid by sum for any work actually performed under this contract unless the Engineer-in-charge will certify in writing the performance of such work and the value payable in respect thereof and the shall only be entitled to be paid the value so certified. In the event of the owner putting in force the powers as stated in a, b, c, above vested in him under the preceding clause, he may, if he so desire, take possession of all or any tools and plant, materials and stores in or upon the work or the site thereof belonging to the contractor, or procured by him and intended to be used for the execution of the work or any part thereof paying or allowing for the same in account at the contract rates to be certified by the Engineer-in-charge whose certificate thereof shall be final otherwise the Engineer-in-charge may give notice in writing to the contractor or his representative requiring him to remove such tools plant materials or stores from the premises within the time specified in the notice and in if the contractor fails to comply with any such notice, the Engineer-in-charge may remove them at the Contractor's expenses or sell them by auction or private sale on account of the contractor and his risks in all respects without any further notice as to the date, time to place of the sale and the certificate of Engineer-in-charge as to the expenses of any such removal and the amount of the proceeds and the expenses of any such sale shall be final and conclusive against the contractor.

**GC-23 NO COMPENSATION FOR ALTERATION IN OR RESTRICTION OF WORK :**

If at any time from the commencement of work, the owner shall for any reasons whatsoever not require the whole or part thereof a specified in the tender to be carried out, the Engineer-in-charge shall give notice in writing of the contractor, who shall have no claim to any payment or compensation whatsoever on account of any profit or advantage which he might have derived from execution of work in full, but which he did not derive in consequence of the full amount of the work not having been carried neither shall he have any claim for compensation by reason if any alternations having been made in original specifications, drawings, designs and instructions which shall involve any curtailment of the work as originally contemplated.

When the contractor is a partnership firm, the prior approval in writing of the S.M.C. shall be obtained before any change is made in the constitution of the firm, where the contractor is an individual or a Hindu Undivided Family business concern, such approval as aforesaid shall, likewise be obtained before sub-contractor enters into any agreement with other parties whereunder the reconstituted firm would have the right to carry out the work hereby undertaken by the contractor. In either case if prior approval as aforesaid is not obtained, the contract shall be deemed to have been allotted in contravention of sub-letting clause hereof and the same action may be taken and the same consequence shall ensure as provided in the sub-letting clause.

**GC-24 IN EVENT OF DEATH OF CONTRACTOR :**

Without prejudice to any of the right or remedies under the contract, if the contractor dies, the owner shall have the option of terminating the contract without compensation to the contractor.

**GC-25 MEMBER OF THE OWNER NOT INDIVIDUALLY LIABLE :**

No official or employee of the owner shall in any way be personally bound or liable for the acts or obligations of the owner under the contract or answerable for any default or omission in the observance or performance of the acts, matters or things which are herein contained.

**GC-26 OWNER NOT BOUND BY PERSONAL REPRESENTATIONS :**

The contractor shall not be entitled to any increase on the Schedule of rates or any other rights or claims whatsoever by reason of representation, explanation or statement or alleged representation, promise or guarantees given or alleged to have been given to him by any person.

**GC-27 CONTRACTOR'S OFFICE AT SITE :**

The Contractor shall provide and maintain an office at the site for the accommodation of his agent and staff and such office shall be opened at all reasonable hours to receive instructions, notice or other communications.

**GC-28 CONTRACTOR'S SUBORDINATE STAFF AND THEIR CONDUCT :**

1. The contractor on award of the work shall name and depute a qualified Engineer, having experience of carrying out work of similar nature, to whom equipments, materials, if, any, shall be issued and instructions for work given. The



contractor shall also provide to the satisfaction of Engineer in-charge sufficient and qualified staff to superintend the execution of the work, competent sub- agents, foremen and leading hands including those specially qualified by previous expeditions to a supervise the type of works comprised in the contract in such manner as will ensure work of the best quality and expeditions working, it, in the opinion of the Engineer-in-charge, additional properly qualified supervision staff is considered necessary, if shall be employed by the contractor without additional charge on account thereof. The contractor shall ensure to the satisfaction of the Engineer- in-charge that sub - contractors, it any shall provide competent and efficient supervision over the work entrusted to them.

2. If and whenever any of the contractor 's or sub-contractor agents, sub-agents, assistance, formen or other employees shall, in the opinion of Engineer-in-charge, be guilty of any misconduct or be incompetent or insufficiently qualified or intelligent in the performance of their duties or that in opinion of the owner or Engineer-in-charge, it is undesirable for administrative or any other reason for person or persons to be employed in the works, the contractor, if so directed by the Engineer-in-charge, shall at once remove person or persons from employment thereon. Any person or persons so removed shall not again be reemployed in connection with the works without the written permission of the Engineer-in-charge. Any person so removed from the works shall be immediately replaced at the expenses of the contractor by a qualified and competent substitute. Should the contractor be required to repatriate any person removed from the works he shall do so and shall bear all costs in connection therewith.

3. The contractor shall be responsible for the proper behaviour of all the staff, foremen, workmen and others shall exercise proper control over them and in particular and without prejudice to the same. Generally, the contractor shall be bound to prohibit, and prevent any employee from trespassing or acting in any way detrimental or prejudicial to the interest of the community or of the properties or occupiers of land and properties in the neighbourhood and in the event of such employees so trespassing, the contractor shall be responsible therefore and relieve the owner of all consequent claims, actions for damages or injury or any other grounds whatsoever. The decision of the Engineer-in- charge upon any matter arising under this clause shall be final.

4. If and required by the owner, the contractor's personnel entering upon the owner's premises shall be properly identified by badges of a type acceptable to the S.M.C. which must be worn at all times on owner's premises.

#### GC-29 TERMINATION OF SUB-CONTRACTOR BY OWNER :

If any sub-contractor engaged upon the works at the site executes any work which in the opinion of Engineer-in-charge is not in accordance with the contract documents, the S.M.C. may give written notice to the contractor request his to terminate such sub-contract and the contractor upon the receipt of such notice shall terminate such sub-contract and the letter shall forthwith leave the works failing which the owner shall have the right to remove such sub-contractors from the site.

No action taken by the owner under the above clause shall relieve the contractor of his liabilities under the contract or give rise to any right to compensation, extension of time or otherwise.

#### GC-30 POWER OF ENTRY :

If the contractor shall not commence the work in the manner previously described in the contract documents or if he shall, at any time, in the opinion of Engineer-in-charge.

- (i) Fail to carry out works in conformity with the documents or
- (ii) Fail to carry out the works in accordance with the time schedule.
- (iii) Substantially suspend work or the works for a period of fourteen days without authority from Engineer-in-charge or
- (iv) Fail to carry out and execute the work to the satisfaction of the Engineer-in-charge or
- (v) Fail to supply sufficient or suitable construction plant, temporary works, labour, materials or things or
- (vi) Commit breach of any other provisions of the contract on his part to be performed or observed or persist in any of the above mentioned breaches of the contract for fourteen days after notice in writing shall have been given to the contractor by the Engineer-in-charge requiring such breach to be remedied or
- (vii) Abandon the work or
- (viii) During the continuance of the contract becomes bankrupt, make any arrangement or compromise with his creditors, or permit any execution to be levied or go into liquidation whether compulsory or voluntary not being merely a voluntary liquidation for the purpose of amalgamation or reconstruction then in any such case.

The owner shall have the power to enter upon the works and take possession thereof and of the materials, temporary works, constructional plant and stock therein, and to revoke the contractor's licence to use the same and to complete the works by his agents, other contractor or workman or to relate the same upon any terms and to such other person, firm or corporation as the owner in his absolute discretion may think proper to employ, and for the purpose aforesaid to use or authorise the use of any materials, temporary works, constructional plant, and stock as aforesaid, without making payment or allowance to the Contractor for the said materials other than such as may be certified in written by the Engineer-in-charge to be reasonable and without making any payment or allowance to the contractor for the use of said temporary works, constructional plant and stock or being liable for any loss or damage thereto. If the owner shall be reason of his taking possession of the works or of the work being got completed by other contractor incur excess certified by the Engineer-in-charge shall be deducted from any money which may be due for the work done by the contractor under





the contract and not paid for. Any deficiency shall forthwith be made good and paid to the owner by the contractor and the owner shall have power to sell in such manner and for such price as he may think fit all or any of the constructional plant, materials etc. constructed by or belonging to and recoup and retain the said deficiency or any part thereof out of the proceeds of the sale.

**GC-31 CONTRACTOR'S RESPONSIBILITY WITH THE OTHER CONTRACTOR & AGENCIES:**

Without repugnance to any other condition, it shall be the responsibility of the contractor executing the work of civil construction to work in close co-operation and co-ordinate the work with other contractors or their authorised representative and the contractor will put a joint scheme with the concurrence of other contractors showing the arrangements for carrying his portion of the work to the Engineer-in-charge and get the approval. The Engineer-in-charge before approving the joint scheme will call the parties concerned and modify the scheme if required. No claim will be entertained on account of the above. The contractor shall conform in all respects with the provisions of any statutory regulations, ordinances or by laws of any local or locally constituted authorities or public bodies which may be applicable from time to time to works or any temporary works. The contractor shall keep the owner indemnified against all penalties and liabilities of every kind arising out of non-adherence to such statutes, ordinance, laws, rules, regulations, etc.

**GC-32 OTHER AGENCIES AT SITE :**

The Contractor shall have to execute the work in such place and condition where other agencies will also be engaged for other works, such as site grading, filling and levelling, electrical and mechanical engineering works, etc. No claim shall be entertained for works being executed in the above circumstances.

**GC-33 NOTICES :**

Any notice under this contract may be served on the contractor or his duly authorised representative at the job site or may be served by registered post direct to the official address of the contractor proof of issue of any such notice could be conclusive of the contractor having been duly informed of all contents therein.

**GC-34 RIGHT OF VARIOUS INTERESTS :**

The owner reserves the right to distribute the work between more than one contractor. Contractor shall co-operate and afford reasonable opportunity to other contractors for access to the works for the carriage and storage of materials and execution of their works.

Wherever the work being done by any department of the owner or by other contractor employed by the owner is contingent upon work covered by this contract, the respective rights of the various interests shall be determined by Engineer-in-charge to secure the completion of various portions of the work in general harmony.

**GC-35 PRICE ADJUSTMENT :**

No adjustment in price shall be allowed as the time limit for completion of the project is less than One year.

**GC-36 TERMS OF PAYMENT :**

The payment of Bills shall be made progressively according to the rules and practice followed by the Municipal Corporation. The progressive payment unless otherwise provided in the Contract Agreement or sub-sequently agreed to by the parties, shall be made generally monthly on submission of a bill by the Contractor in prescribed form in an amount according to the value of the work performed less the aggregate of previous progressive payments and as required by clause GC-37 (Retention money) herein. All such progressive payment shall be regarded as payment by way of advance against final payment.

Payment for the work done by the contractor will be based on the measurement at various stages of the work, in accordance with the conditions at Clause GC-77 (Measurement of Work in Progress)

**GC-37 RETENTION MONEY :**

Pursuant to Clause GC-36 Terms of Payment) on all money due to the contractor for work done, **Municipal Corporation will hold as retention money of Seven percent (7%) of the value of work.** The retention money will not normally be due for payment until the completion of the entire work and till such period the work has been finally accepted by the Municipal Corporation and completion certificate issued by the Municipal Corporation in pursuant to Clause No.GC-83 (Completion Certificate).

However, after the assurance of completion certificate, and Municipal Commissioner may at its own discretion and having considered the Contractor's performance and diligence during the contract time allow the retention money to converted into a Bond as stipulated in the Clause GC-10 (Performance Bond Security Deposit).

**GC-38 PAYMENT DUE FROM THE CONTRACTOR :**

All costs, damages or expenses, for which under the Contract the Contractor is liable to the Municipal Corporation deducted by the Municipal Corporation from any money due or becoming due to the Contractor under the contract or from



any other contract with the Municipal Corporation or may be recovered by action at law or other-wise from the Contractor.

**GC-39 CONTINGENT FEE :**

1. The Contractor warrants that he has not employed any person to solicit or secure the contract upon any agreement for a commission, percentage, brokerage or contingent fee. Breach of this warranty shall give the Municipal Commissioner the right to cancel the contract or to take any other measure as the Municipal Commissioner may deem fit. The warranty does not apply to commissions payable by the contractor to establish commercial or selling agent for the purpose of securing business.
2. No officer, employer of the Municipal Corporation be admitted to any share or part of this contract or to any benefit that may rise therefrom.

**GC-40 BREACH OF CONTRACT BY CONTRACTOR :**

If the contractor fails to perform the work under the contract with due diligence or shall refuse or neglect to comply with instruction given to him in by the Engineer-in-charge accordance with the contract, or shall contravene the provisions of the contract, the S.M.C. may give notice in writing to the contractor to make good such failure, neglect or contravention. Should the Contractor fail to comply with such written notice within twenty eight (28) days or receipt, if the Municipal Commissioner shall think fit, it shall be lawful for the Municipal Corporation, without prejudice to any other rights, the contractor may have under the contract, to terminate the contract for all or part of the works, and to make any other arrangements it shall deem necessary to complete the work outstanding under the contract at the time of termination. In this event Article GC-15 (Subletting of work) and GC-16 (Sub-Contracts for Temporary Works etc.) hereof shall be invoked and the performance Bond shall immediately become due and payable to the Municipal Commissioner the value of the work done on the date of termination and not paid for shall stand forfeited to the Municipal Corporation and the Municipal Corporation shall have free use of any works which the contractor may have at the site at the time of termination of the contract.

**GC-41 DEFAULT OF CONTRACTOR :**

1. The Municipal Corporation may upon written notice of default to the contractor terminate the contract in circumstance detailed hereunder :
  - (a) If in the judgement of the Municipal Corporation the contractor fails to make completion of works within the time specified in the completion schedule or within the period for which extension has been granted by the Municipal Corporation /Engineer to the Contractor.
  - (b) If in the judgement of the Municipal Corporation the contractor fails to comply with any of the provisions of this contract.
2. In the event the Municipal Commissioner terminates the contract in whole or in part as provided in Article GC-48 (Termination of Contract), the Municipal Corporation reserves the right to purchase upon such terms and in such manner as it may deem appropriate, plant similar to that terminated and the contractor will be liable to the Municipal Corporation for any additional costs for such similar and / or for liquidated damages for delay until such reasonable time as may be required for the final completion of works.
3. If this contract is terminated as provided in this paragraph GC - 30 (Power of entry) (1) the Municipal Corporation in addition to any other rights provided in this clause, may require the Contractor to transfer title and deliver to the Municipal Corporation under any of the following cases in the manual and as directed by the Municipal Corporation. (a) Any partially completed information and contract rights as the contractor has specifically produced or acquired for the performance of the contract so terminated.
4. In the event the Municipal Corporation does not terminate the contract as provided in the paragraph GC- 48 (Termination of Contract) the Contractor shall continue performance of the contract, in which case the shall be liable to the Municipal Corporation for liquidated damages for delay until the works are accepted.

**GC-42 BANKRUPTCY :**

If the Contractor shall become bankrupt or insolvent or have a receiving order made against him, or compound with the creditors, or being the Municipal Corporation commence to be wound up, not being a member's Voluntary winding up for the purpose of amalgamation or reconstruction, or carry on its business under a receiver for the benefit of his creditors or any of them, the owner shall be at liberty to either (a) terminate the contract forthwith by giving notice in writing to the contractor or to the receiver or liquidator or to any person or organisation in whom the contract may become vested and to act in the manner provided in Article GC-41 (Default of Contractor) as though the last mentioned notice had been the notice referred to in such Article of (b) to give such receiver liquidator or other person in whom the contract may become vested the option of carrying out the contract subject to his providing a satisfactory guarantee for the due and faithful performance of the contract subject to his providing a satisfactory guarantee for the due and faithful performance of the contract upto an amount to be agreed. In the event that the Municipal Corporation terminates the Contract in accordance with this article, the performance Bond shall immediately become due and payable on demand to Municipal Corporation.

**GC-43 OWNERSHIP :**

Works supplied pursuant to the Contract shall become the property of the Municipal Corporation from whichever is the earlier of the following times, namely,

- (a) When the works are completed pursuant to the Contract.
- (b) When the Contractor has been paid any sum to which he may become entitled in respect thereof pursuant to clause GC-36 (Terms of Payment).

**GC-44 DECLARATION AGAINST WAIVER :**

The condonation by the Municipal Corporation of any breach of breaches by the stipulations and conditions contained in the contract shall in no way prejudice or effect to the constructed as a waiver of the Municipal Corporation rights, powers and remedies under the contract in respect of any breach or breaches.

**GC-45 LAWS GOVERNING THE CONTRACT :**

The contract shall be constituted according to and Subject to the laws of India and the State of Gujarat and under the jurisdiction of the courts of Gujarat at Surat.

**GC-46 OVERPAYMENT AND UNDERPAYMENT :**

Whenever any claim for payment of a sum to the Municipal Corporation arises out of or under this Contract against the contractor the same may be deducted by the Municipal Corporation from any sum then due or which at any time thereafter may become due to the contractor under this contract and failing that under any other contract with the Municipal Corporation or from any sum due to the contractor with the Municipal Corporation (which may be available with Municipal Corporation), or from his retention money, or he shall pay the claim on demand. The Municipal Corporation reserves the right to carry out post payment audit and technical examination of the final bill including all supporting vouchers, abstracts, etc.

The Municipal Corporation further reserves the right to enforce recovery of any over payment when detected notwithstanding the fact that the amount of the final bill may be included by the Contractor.

If as a result of such audit and technical examination any over payment is discovered in respect of any work done by the Contractor or alleged to have been done by him under the contract, it shall be recovered by the Municipal Corporation from the contractor by way of all the means prescribed above or if any under payment is discovered by the Municipal Corporation, any amount due to the contractor under this contract or under payment may be adjusted against any amount then due or which may at any time thereafter become due before payment is made to the contractor from him to the Municipal Corporation on any other contract account whatsoever.

**GC-47 SETTLEMENT OF DISPUTES :**

Except or otherwise specifically provided in the contract, all disputes concerning questions of fact arising under the contract shall be decided by the Commissioner, subject to a written appeal by the Contractor to the Commissioner, and these decisions shall be final and binding to the contractor.

**GC-48 TERMINATION OF THE CONTRACT:**

1. If the Contractor finds it impracticable to continue operation owing to Force Majeure reasons or for any reason beyond his and/or the Municipal Commissioner find site impossible to continue operation when prompt notification in writing shall be given by the party affected to the other.

2. If the delay or difficulties so caused can not be expected to cease or become unavoidable or if operations can not be resumed within six(6) months the party shall have the right to terminate the contract upon Ten (10) days written notice to the other. In the event of such termination of the contract, payment to the Contractor will be made as follows :

- a) The Contractor shall be paid for all works approved by the Engineer and for any other legitimate expenses due to him.
- b) If the Municipal Commissioner terminates the contract owing to Force Majeure or due to any cause beyond its control, the contractor shall additionally be paid for any work done during the said Six (6) months period including any financial commitment made for the proper performance of the Contract and which are not reasonable defrayed by payment under (a) above;

c) The Municipal Commissioner also release all bonds and guarantees at its disposal except in case where the total amount of payments made to the contractor exceeds the final amount due to him in which case the contractor shall refund the excess amount within Sixty (60) days after termination and the Municipal Commissioner thereafter shall release all bonds and guarantees, should the contractor fail to refund the amount received in excess within the said period such amounts shall be deducted from the bonds or guarantees provided.

3. On the termination of the contract for any cause the contractor shall see the orderly suspension and termination of operations, with due consideration to the interests of the Municipal Corporation with respect to completion, safeguarding or storing of materials procured for the performance of the contract and the salvage and resale thereof.

**GC-49 CHANGES IN CONSTITUTION :**

Where the contractor is a partnership firm, the prior approval in writing of the Municipal Commissioner shall be obtained any change is made in the constitution of the firm. Where the contractor is an individual or an undivided family



business concern such approval as aforesaid shall like wise be obtained before the contractor enters into any partnership agreement whereunder the partnership firm would have the right to carry out the works hereby undertaken by the contractor. If prior approval as aforesaid is not obtained the contract shall be deemed to have been assigned in contravention of Article thereof.

**GC-50 SUB-CONTRACTUAL RELATIONS :**

All work performed for the contract by sub-contractor shall be pursuant to an appropriate agreement between the contractor and sub-contractor which shall contain provisions to :

- a) Protect and preserve the rights of the Municipal Corporation and the Engineer with respect to the work to be performed under the sub-contract so that the sub-contractor thereof will not prejudice such rights.
- b) Require that such work be performed in accordance with requirements of the Contract documents.
- c) Require under such contract of which the contractor is a party, the submission to the contractor of application for payment and claims for additional costs, extension of time, damages for delay or otherwise with respect to the sub-contracted portions of the work in sufficient time, that the contractor may apply for payment and comply in accordance with the contract Documents for like claim by the Contractor upon the Municipal Corporation.
- d) Waive all rights the contracting parties may have against one another for damages caused by fire or other perils covered by the property insurance except such rights as they may have to the proceeds so such insurance held by the Municipal Corporation as trustee and,
- e) Obligate each sub-contractor specifically to consent to the provisions of this Article.

**GC-51 LIEN :**

If, at any time, there should be evidence of any lien or claim for which owner might have become liable and which is chargeable to the contractor, the owner shall have the right to retain out of any payment then due or thereafter to become due an amount sufficient to completely indemnify the owner against such lien or claim or if such lien or claim be valid the owner may be or become due and payable to the contractor. If any lien or claims remaining, unsettled after all payments are made, the contractor shall refund or pay to the owner all money that the latter may be compelled to pay in discharging such lien or claim including all cost and reasonable expenses.

**GC-52 EXECUTION OF WORK :**

The whole work shall be carried out in strict conformity with the provisions of the Contract Documents, detailed drawings, specifications and the instructions of the Engineer-in-charge from time to time. The Contractor shall ensure that the whole work is executed in the most substantial, proper and best workmanship using materials of best quality in strict accordance with the specifications to the entire satisfaction of the Engineer-in-charge.

**GC-53 WORK IN MONSOON :**

When the work continues in monsoon, the contractor shall maintain minimum labour force required, for the work and plan and execute the construction and erection work according to the prescribed schedule. No extra rate will be considered for such work in monsoon. During monsoon and entire constructing period the contractor shall keep the site free from water at his own cost.

**GC-54 WORK CLOSED ON SUNDAYS & HOLIDAYS & BETWEEN SUNSET AND SUNRISE:**

No work shall be carried out on Sundays and Corporation Holidays and no work shall be carried out between sunset and sunrise. Except with the special permission of Engineer-in-charge in writing previously obtained and with holding such permissions shall be no ground of complaint on the part of contractor or cause for compensation to them. Working period shall be maximum eight (8) hours per days.

**GC-55 EXTRA SUPERVISION CHARGES TO BE BORNE BY CONTRACTOR :**

Further to clause No.GC-54 when Engineer-in-charge feels necessary to give permission to contractor for carrying out work for period of more than Eight hours working period in a day and/or to continue work on Sunday and Corporation holidays. Extra Supervision charges arising due to overtime working of Corporation's staff shall be borne by the contractor at prevailing rates from time to time. Such extra supervision charges shall be deducted by Corporation from the running bill/s of the contractor at Surat Municipal Corporation's description.

**GC-56 DRAWING TO BE SUPPLIED BY THE OWNER :**

The drawings attached with the tender documents shall be for general guidance of the contractor to enable him to visualize the type of work contemplated and scope of work involved. Detailed working drawings according to which the work is to be done shall be furnished from time to time as the work progresses. The contractor shall study the drawings thoroughly in connection with other connected details and discrepancy if any bring to the notice of the Engineer-in-charge before actually carrying out the work.

**GC-57 DRAWINGS TO BE SUPPLIED BY THE CONTRACTOR :**





Where drawings, date are to be furnished by the contractor they shall be as enumerated in special condition of contract and shall be furnished within the specified time. Where approval of drawings has been specified it shall be the Contractor's responsibility to have these drawings got approved before any work is taken up with regard to the same. Any changes becoming necessary in these drawings during the execution of the work shall have to be carried out by the contractor at no extra cost. All final drawings shall bear the certification stamp as indicated below duly signed by both the contractor and Engineer- in-charge.

"Certified true for \_\_\_\_\_ project Agreement

No. \_\_\_\_\_ Signed \_\_\_\_\_ Contractor Engineer-  
in-charge Drawings will be approved within three (3) weeks of the receipt of the same by the Engineer-in-charge.

#### GC-58 SETTING OUT WORK :

The contractor shall set out the work on the site handed by the Engineer-in-charge and shall be responsible for the correctness of the same. The work shall be carried out to the entire satisfaction of Engineer-in-charge. The approval thereof or partaking by Engineer-in-charge in setting out work shall not relieve contractor of any of his responsibilities.

The contractor shall provide at his own cost all necessary level posts, pegs, bamboos, flage, ranging, rods, strings and other materials and labourers required for proper setting out of the work. The Contractor shall provide, fix and be responsible for the maintenance of all stakes, temples level marks profiles and similar other things and shall take and necessary precautions to prevent their removal or disturbance and shall be responsible for the consequence for such removal or disturbance. The contractor shall also be responsible for the maintenance of all existing Survey Marks, Boundary Marks, Distance Marks and Centre line marks either existing or fixed by the Contractor. The Centre, longitudinal or face lines and cross lines shall be marked by small masonry pillars. Each pillar shall have distance mark at the centre for setting up the theodolite. The work shall not be started unless the setting out is checked by Engineer-in-charge in writing but such approval shall not relive the contractor of his responsibilities. The contractor shall provide all materials, labour and other facilities necessary for checking at his own cost.

Pillars bearing geodetic marks on site shall be protected by the Contractor. On completion of the work the contractor shall submit the Geodetic documents according to which the work has been carried out.

#### GC-59 RESPONSIBILITIES OF CONTRACTOR FOR CORRECTNESS OF WORK:

The contractor shall be entirely and exclusively responsible for the correctness of every part of the work and shall rectify completely and errors thereon at his own cost when so instructed by Engineer-in-charge.

##### 1. Materials to be supplied by Contractor :

Contractor shall procure and provide all the materials required for the execution and maintenance of work including M.S. rods, all tools, tackle, construction plant and equipment except the materials to be supplied by the owner detailed in the contract documents and for the transport thereof, owner, shall made recommendations to the respective authorities if designed by the contractor but assumes no responsibility or any nature. Owner shall insist for procurement of materials with ISI Marks supplied by reputed firms on the DGS & D List. 2. If however the Engineer-in-charge feels that work is likely to be delayed due to contractor's inability to procure the materials, the Engineer-in-charge shall have the right to procure materials from the market and the contractor will accept these materials at the rates decided by Engineer-in-charge

#### GC-60 MATERIALS TO BE SUPPLIED BY THE OWNER :

1. If the contract provides certain materials or stores to be supplied by the S.M.C. such materials and stores shall be transported by the contractor at his cost from S.M.C's stores or Railway Station. The sum due from contractor for the value of materials supplied by the owner will be recovered from the R.A.Bill on the basis of actual consumption of materials in the work covered and for which R.A.Bill has been prepared. After completion of the work contract has to account for the full quantity of materials supplied to him.

2. The value of store materials supplied by the S.M.C. to the contract shall be charged at rates shown in the contract document and in case any other material not listed in the schedule of materials is supplied by the S.M.C., the same shall be charged at cost price including carting and other expenses incurred in procuring the same. All materials so supplied shall remain the property of the owner and shall not be removed from the site on any account. Any material remaining un-used at the time of completion of work or termination of contract shall be returned to S.M.C.'s store or any other place as directed by the Engineer-in-charge in perfectly good condition at contractor's cost. When materials are supplied free of cost for us in work and surplus and unaccounted balances thereof are not returned to the Municipal Corporation, recovery in respect of such balance will be effected at double the applicable issue rate of the materials or the market rate whichever is higher.

#### GC-61 CONDITIONS OF ISSUE OF MATERIALS BY THE S.M.C.:

a) The materials specified to be issued by the S.M.C. to the contractor shall be issued by the S.M.C.'s store or at Railway Station and all expenses for its shifting to site shall be borne by the contractor. The materials will be issued during working hours and as per rules of S.M.C. from time to time.



- b) Contractor shall bear all expenses for storage and safe custody at site of materials issued to him before use in work.
- c) Material shall be issued by the S.M.C. in Standard/non-standard sizes as obtained from manufacturer.
- d) Contractor shall construct suitable godowns at site for storing the materials to protect the same from damage due to rain, dampness, fires, theft etc.
- e) The contractor should take the delivery of the materials issued by the S.M.C. after satisfying himself that they are in good conditions. Once the materials are issued, it will be the responsibility of the Contractor to keep them in good condition and in safe custody. If the materials get damaged or if they are stolen, it shall be the responsibility of the contractor to replace them at his according to the instructions of the Engineer-in-charge.
- f) For delay in supply or for non supply of materials to be supplied by the S.M.C., on account of natural calamities, act of enemies, other difficulties beyond the control of the S.M.C., the S.M.C. carries non-responsibilities. In no case the contractor shall be entitled to claim any compensation for loss suffered by him on this account.
- g) None of the materials issued to the contractor, shall be used by the Contractor for manufacturing items which can be obtained from manufacturer. The materials issued by the owner shall be used for the work only and no other purpose.
- h) Contractor shall be required to execute indemnity bond in the prescribed form for the same custody and account of materials issued by the owner.
- i) Contractor shall furnish sufficiently in advance a Statement of his requirements of quantities of materials to be supplied by the S.M.C. and the time when the same will be required for the work, so as to enable Engineer-in-charge to make arrangements to procure and supply the materials.
- j) A daily account of materials issued by the owner shall be maintained by the Contractor showing receipt, consumption and balance in head in the form laid down by Engineer-in-charge with all connected paper and shall be always available for inspection in the site office. k) Contractor shall see that only the required quantities of materials are got issued and no more. The contractor shall be responsible to return the surplus materials in good condition at S.M.C.'s store at his own cost.

**GC-62 MATERIALS PROCURED WITH ASSISTANCE OF THE OWNER :**

Notwithstanding anything contained to the contrary in any of the clauses of this contract, where any materials for the execution of the contract are procured with the assistance of the S.M.C. either by issue from S.M.C. stock or purchase made under orders or permits or licences issued by the Government, the contractor shall hold the same materials as trustees for owner and use such materials economically and solely for the purpose of contract and not dispose them off without the permission of S.M.C. and return, if required by Engineer-in-charge, all surplus or unserviceable materials that may be left with him after the completion of the contract or at its termination for any reason whatsoever on his being paid or credited such prices as Engineer-in-charge shall determine having due regard to the conditions of the materials. The price allowed to contractor shall not exceed the amount charged to him excluding the storage charges if any. The decision of Engineer-in-charge shall be final and conclusive in such matters. In the event of breach of the aforesaid condition, the contractor shall in terms of licence of permits and/or for criminal breach of trust be liable to compensate S.M.C. at double rate or any higher rates. In the event of these materials at that time having higher rate or not being available in the market then any other rate to be determined by the Engineer-in-charge and his decision shall be final and conclusive.

**GC-63 MATERIALS OBTAINED FROM DISMANTLING :**

If the contractor, in the course of execution of work is called upon to dismantle any part for reasons other than on account of bad or imperfect work, the materials obtained from dismantling will be the property of the S.M.C. and will be disposed of as per instruction of Engineer-in-charge in the best interest of the S.M.C.

**GC-64 ARTICLE OF VALUE OR TREASURE FOUND DURING CONSTRUCTION:**

All gold, silver and other minerals of any description and all precious stones, coins, treasures, relics, antiquities and other similar things which shall be found in under or upon site shall be the property of the owner and the contractor shall property preserve the same to the satisfaction of Engineer-in-charge and shall hand over the same to the owner.

**GC-65 DISCREPANCIES BETWEEN INSTRUCTIONS :**

If there is any discrepancy between the various stipulations of the contract documents of instructions to the contractor or his authorised representative or if any doubt arises as in the meaning of such stipulation or instructions, the contractor shall immediately refer in writing to the Engineer-in-charge whose decision shall be final and conclusive and no claim for losses caused by such discrepancy, shall in any event be admissible.

In case there is any discrepancy in measurements shown in drawing and specifications, the same shown in drawing shall be considered as final and will be binding upon the contractor.

**GC-66 SCHEDULE OF QUANTITIES AND EXTRA ITEMS :**

**A. Schedule of Quantities :**

Variations in the quantities of work in schedule of quantities shall not vitiate the contract. The rates quoted for the individual items shall apply for the quantities of work increased or decreased by not more than twenty percent for each



of the items, should the quantities of work actually involved under any item vary by more than thirty (30%) percent, the rate for such item of work shall be revised in accordance with the procedures indicated under clause "Extra Items". The payment for the items will, however, continue to be at the original rate till the revised rate decided.

**B. Extra Items :**

**Extra Items of work shall not vitiate the contract. The contractor shall be bound to execute extra items of work as directed by the Engineer-in-charge. The rates for extra items shall be derived from the S.O.R.(R&B Division) Year 2015-2016 and quoted premium of tender. If the rate of extra item is not available in S.O.R. it will be derived on prevailing market rate.**

**GC-67 ACTION WHEN NO SPECIFICATION IS ISSUED :**

In case of any class of work for which no specification is supplied by the S.M.C. in the tender documents, such work shall be carried out in accordance with I.S.S. do not cover the same, the work should be carried out as per standard Engineering practice subject to the approval of Engineer-in-charge.

**GC-68 ABNORMAL RATES :**

Contractor is expected to quote rate for each item after careful analysis of cost involved for the performance of the completed item considering all specifications and conditions of contract. This will avoid loss of profit or gain in case of curtailment or change or specification for any item. In case it is noticed that the rates quoted by a tenderer for any item is usually high or unusually low, it will be sufficient cause for rejection of tender unless the S.M.C. is convinced about the reasonableness of the rates on scrutiny of the analysis for such rate to be furnished by the tenderer or demand.

**GC-69 ASSISTANCE TO ENGINEER-IN-CHARGE :**

Contractor shall make available to Engineer-in-charge free of cost all necessary instruments and assistance in checking of any work made by the contractor for taking measurement of work.

**GC-70 TEST OF QUALITY OF WORK :**

1. All workmanship shall be of the best kind described in the contract document and in accordance with the instructions of Engineer-in-charge and shall be subjected from time to time to such test at contractor's cost as the Engineer-in-charge may direct at the place of manufacture of fabrication or on site or at any such place. Contractor shall provide assistance, instruments, labour and materials as are normally required for examining, measuring and testing any work, workmanship as may be selected and required by Engineer-in-charge.
2. All tests will be necessary in connection with the execution of work as decided by Engineer-in-charge shall be carried out at an approved laboratory at contractor's cost.
3. The contractor shall furnish to Engineer-in-charge for approval when requested or if required by the specification adequate samples of all materials and finished goods to be used in work and sufficiently in advance to permit test and examination thereof. All materials furnished and finished goods applied in work shall be exactly as per the approved samples.
4. All the testing charges shall be borne by the Contractor.

**GC-71 ACTION AND COMPENSATION IN CASE OF BAD WORKMANSHIP :**

If it shall appear to the Engineer-in-charge that any work has been executed with materials of inferior description, or quality or are unsound or with unsound, imperfect or unskilled workmanship or otherwise not in accordance with the contract, shall, no demand in writing from Engineer-in-charge or his authorised representative specifying the work, materials or articles complained of, notwithstanding that the same may have been inadvertently passed, certified and paid for forthwith rectify or remove and reconstruct the work, specified and in the event of failure to do so within a period to be specified by Engineer-in-charge in his aforesaid demand, contractor shall be liable to pay compensation at the rate of one (1) percent of the tendered cost of work for every Ten (10) days limited to a maximum of Ten (10%) Percent of the value of work while his failure to do so continues and in the case of any such failure the Engineer-in-charge may on expiry of the notice period rectify and remove and re-execute the work or remove and replace with other at the risk and cost of the Contractor. The decision of the Engineer-in-charge as to any question arising under this clause shall be final and conclusive.

**GC-72 SUSPENSION OF WORK :**

Contractor shall, if ordered in writing by Engineer-in-charge or his representative temporarily suspended the work or any part thereof for such time (not exceeding two months) as ordered and shall not after receiving such written order proceed with the work until he shall have received a written order to proceed therewith the contractor shall not be entitled to claim compensation for any loss or damage sustained by him by reason of temporary suspension of work as aforesaid. An extension of time for completion of work will be granted to the contractor corresponding to the delay caused by such suspension of work if the applied for the same provided the suspension was not consequent upon any default or failure on the part of the contractor.

**GC-73 OWNER MAY DO PART OF THE WORK :**

When the contractor fails to comply with any instructions given in accordance with the provisions of this contract, the S.M.C. has the right to carry out such parts of work as the S.M.C. may designate whether by purchasing materials and engaging labour or by the agency of another contractor. In such case the S.M.C. shall deduct from the amount which otherwise might become due to contractor the cost of such work and materials with Ten (10%) percent added to cover all departmental charges and should the total amount thereof exceed the amount due to contractor, contractor shall pay the difference to S.M.C.

**GC-74 POSSESSION PRIOR TO COMPLETION :**

The Engineer-in-charge shall have the right to take possession of or to use any completed or partly completed work or part of work, such possession or use shall not be deemed to be an acceptance of any work completed in accordance with the contract. If such prior possession or use by Engineer-in-charge delays the progress of work, equitable adjustment in the time of completion will be made and the contract shall be deemed to be modified accordingly.

**GC-75 COMPLETION CERTIFICATE :**

As soon as the work has been completed in accordance with contract (except in minor respect that do not effect their use for the purpose for which they are intended and except for maintenance thereof) as per general conditions of contract and has passed the tests on completion, the Engineer-in-charge shall issue a certificate (hereinafter called completion certificate) in which he shall certify the date on which work has been completed and has passed the said tests and S.M.C. shall be deemed to have taken over work on the date so certified. If work has been divided in various groups in contract, S.M.C. shall be entitled to take over any group or groups before the other or others and there-upon the Engineer-in-charge will issue a completion certificate which will, however, be for such group or groups so taken over only. In order that contractor could obtain a completion certificate, he shall make good, with all speed any defect arising from the defective materials supplied by contractor or workmanship or any act or omission of contract that may have been discovered or developed after the work or group of works has been taken over. The period allowed for carrying out such work will be normally, one month. If any defect be not remedied within a reasonable time, S.M.C. may proceed to do work at contractor's risk and expenses and deduct from the final bill such amount as may be decided by S.M.C. If by reason of any default on the part of the contractor, a completion certificate has not been issued in respect of every portion of work within one month after the date fixed by contractor for completion of work, S.M.C. shall be at liberty to use work or any portion thereof in respect of which a completion-certificate has been issued, provided that work or the portion thereof so used as aforesaid shall be afforded reasonable opportunity for completion of this work for the issue of completion certificate.

**GC-76 SCHEDULE OF RATES :**

1. The price/rates quoted by the contractor shall be remain firm till the issue of final certificate and shall be subject to price ADJUSTMENT CLAUSE GC-35. Schedule of rates shall be deemed to include and cover all costs expenses and liabilities of every description and all risks of every kind to be taken in executing, completing and handling overwork to owner by contractor. Contractor shall be deemed to have known the nature, scope, magnitude and the extent of work and materials required through contract documents may not fully and precisely furnish them. He shall make such provision in the schedule of rates as he may consider necessary to cover the cost of such items of work and materials as may be reasonable and necessary to completion work. The opinion of Engineer-in-charge as to the item of work shall be final and binding on Contractor although the same may be not shown on or described specifically in contract documents.
2. The Schedule of rates shall be deemed to include and cover the cost of all constructional plant, temporary work, pumps, materials, labour and all other materials in connection with each item in schedule of rates and the execution of work or any portion thereof furnished complete in every respect and maintained as shown or described in the contract document or as may be ordered in writing during the continuance of the contract.
3. The Schedule of rates shall be deemed to include and cover the cost of all royalties and free for the articles and processes, protected by letters patent or otherwise incorporated in or used in connection with work, also all royalties, and other payments in connection with materials of whatsoever kind for work and shall include an indemnity to-owner which contractor hereby gives against all action, proceeding, claims, damages, costs and expenses arising from the incorporation in use of work of any such articles, processes or materials. Octroi of other Municipal or Local Board charges if levied on materials equipment of machineries to be brought to site for use on work shall be borne by the contractor.
4. No exemption or reduction of custom duties excise duties, sales-tax or any other taxes or charges of the Central or State Government any local body whatsoever will be granted to be obtained. All of such expenses shall be deemed to have been included in and covered by schedule of rates. Contractor will also obtain and pay for all permits or other privileges necessary to complete work.
5. The schedule of rates shall be deemed to include and cover risk on account of delay or interference with contractor's conduct of work which may occur from any cause including orders of S.M.C. in the exercise of his power and no account of extension of time granted due to various reasons.
6. For work under unit rate basis no alteration will be allowed in the schedule of rates by reason of work or any part of them being field, altered extended, diminished or omitted.



**GC-77 PROCEDURE FOR MEASUREMENT OF WORK IN PROGRESS :**

1. All measurements shall be in metric system. All the work in progress will be jointly measured by the representative of Engineer-in-charge and contractor's authorised agent. Such measurements will be got recorded in the measurement book by the Engineer or his authorised representative and signed by contractor or his authorised agent in token of acceptance. If the contractor or his authorised agent fails to be present when even required by the Engineer-in-charge for taking measurements for any reasons whatsoever, the measurement will be taken by the Engineer - in - charge or his authorised representative notwithstanding the absence of contractor and these measurements will be deemed to be correct and binding on contractor.
2. Contractor will submit a bill in approved form in duplicate to the Engineer - in - charge of the work giving abstract and detailed measurements of various items executed during a month as mutually agreed. The Engineer-in-charge shall verify the bill and the claim, as far as admissible, adjusted if possible, within 10 days of presentation of the bills.
3. In case of Tenders for completed items of work, contractor may be allowed 'Secured Advance' on the Security of materials brought to site for execution of the constructed items of work the extent of 75% of the value of materials of unperishable nature and an agreement be drawn up with contractor under which the owner secured a lien on these materials and is safe guarded against losses due to any reasons whatsoever. Recoveries of advance paid would not be post-poned till the whole work is completed but shall be adjusted from his work done or the materials used, the necessary deductions being made when the items of work in which they are used and are billed for. When the mode of measurement is not covered by contract for any item of work it shall be as per latest I.S.I.

**GC-78 RUNNING ACCOUNT PAYMENT TO BE RECOVERED AS ADVANCES :**

1. All running account payments shall be regarded as payments by way of advance against the final payment only and not as payment for work actually done and completed and shall not preclude the requiring of bad, unsound and imperfect or unskilled work to be removed and taken away and reconstructed or to be considered as an admission of the due performance of contract or any part thereof.

**GC-79 NOTICE FOR CLAIM FOR ADDITIONAL PAYMENT :**

If the contractor considers that he is entitled to extra payment or compensation or any claim whatsoever in respect of work, he shall forthwith give notice in writing to the Engineer-in-charge about his extra payment and/or compensation. Such notice shall be given to the Engineer-in-charge within Ten (10) days from the happening of any event upon which contractor basis such claims and such notice shall contain full particulars of the nature of such claim with full details and amount claimed. Failure on the part of the contractor to put forward any claim with the necessary particulars as above within the time above specified shall be an absolute waiver thereof. No commission by S.M.C. to reject any such claim and no delay in dealing therewith shall be waiver by S.M.C. of any rights in respect thereof.

**GC-80 PAYMENT OF CONTRACTOR'S BILL :**

1. The price to be paid by the S.M.C. to contractor for the work to be done and for the performance of all the obligations under taken by the contractor under contract shall be based on the contract price and payment to be made accordingly for the work actually executed and approved by the Engineer-in-charge.
2. No payment shall be made for work costing less than Rs. 5,000/- till the work is completed and a certificate of completion given. But in case of work estimated to cost more than Rs. 5,000/- contractor on submitting the bill thereof will be entitled to receive a monthly payment, proportionate to the part thereof, approved and passed by Engineer-in-charge whose certificate of such approval and assign of the sum so payable shall be final and conclusive against contractor. This payment will be made after making necessary deductions as stipulated elsewhere in the contract documents for materials, security deposit, etc. The payment shall be released to the contractor within Thirty (30) days of submission of the bill in case of running bill and within two (02) months in case of final bill, contractor shall present the bill duly pre-receipted on proper revenue stamp. Payment due to Contractor shall be made by the by crossed Accounts payee cheque in Indian currency forwarding the same to the registered office of the contractor. Owner shall not be responsible if the cheque is mislaid or misappropriated by unauthorised person.

**GC-81 FINAL BILL :**

The final bill shall be submitted by Contractor within two (02) month of the date of physical completion of work, Otherwise the Engineer-in-charge certificate of the measurement and of total amount payable for work shall be finalised binding on all parties.

**GC-82 RECEIPT FOR PAYMENT :**

Receipt for payment made on account of work when executed by a firm must be signed by a person holding power of attorney in this respect on behalf of contractor except when described in the tender as a limited company in which case the receipt must be signed in the name of the company by one of its principal officers or by some other person having authority to give effectual receipt for the Company.

**GC-83 COMPLETION CERTIFICATE :**

1. When the contractor fulfil his obligation as per terms of contract he shall be eligible to apply for completion certificate. Contractor may apply for separate completion certificate in respect of each such portion of work by submitting the completion documents alongwith such application for completion certificate.

The Engineer-in-charge shall normally issue to contractor the completion certificate within 2 (Two) month after receiving an application thereof from contractor after verifying from the complete documents and satisfying himself that work has been completed in accordance with and as set out in the construction and erection drawings and the contract document. Contractor after obtaining the completion certificate is eligible to present the final bill for work executed by him under the terms of contract.

2. Within 2 (Two) month of completion of work in all respect contractor shall be furnished with a certificate by the Engineer-in-charge of such completion but no certificate shall be given nor shall work be deemed to have been executed, until all (1) scaffolding, surplus materials and rubbish is clearing off site completely (2) until work shall have been measured by the Engineer-in-charge whose measurement shall be binding and conclusive and (3) until all the temporary works, labour and staff colonies etc. constructed are removed and the work site cleaned to the satisfaction of the Engineer-in-charge. If contractors shall fail to comply with the requirements as aforesaid or before date fixed for the completion of work, the Engineer-in-charge may at the expenses of contractor remove such scaffolding, surplus materials and rubbish and dispose of the same he thinks fit.

3. The following documents will form the completion documents :

(a) Technical documents according to which work was carried out.

(b) Construction drawings showing therein the modifications and corrections made during the course of execution signed by Engineer-in-charge.

(c) Completion certificate for "Embedded" or "Covered" up work.

(d) Certificate of final levels as set out for various works.

(e) Material appropriation statement for the materials issued by owner for work and list of surplus materials returned to S.M.C.'s store duly supported by necessary documents.

4. Upon expiry of the period of defects liability and subject to Engineer-in-charge being satisfied that work has been duly maintained by contractor during the defects liability period as fixed originally, or as external subsequently and the contractor has in all respects made up by subsidence and performed all his obligations under contract, the Engineer-in-charge shall (without prejudice to the rights of owner in any way) give final certificate to that effect. The Contractor shall not be considered to have fulfilled the whole of his obligation until final certificate shall have been given by the Engineer-in-charge notwithstanding previous entry upon and taking possession, working or usign of the same or any part thereof by owner.

5. Final Certificate only Evidence of Completion :

Except the final certificate no other certificate or payments against a certificate or an general account shall be taken to be an admission by owner of the due performance of contract or any part thereof or of occupancy validity of any claim by the contractor.

**GC-84 TAXES, DUTIES, OCTROI, ETC. :**

The Contractor shall be liable to payment of all the Central/ State/Local Bodie's Levies, taxes or duties etc. The SMC shall neither bear it nor reimburse at any time but will ensure deduction of Central/State/Local levies and taxes at Source at the rate provided under the relevant statutes from time to time inforce. Further the work contract tax or sale tax shall be borne by the Contractor as per Rules and Regulations of Government.

**1% Construction Cess will be deducted from respective R.A. Bill and Final bill in accordance with the prevailing norms of Govt. of Gujarat.**

**GC-85 INSURANCE :**

Contractor shall at his own expenses carry and maintain with reputable Insurance Companies to the satisfaction of owner as follows :

1. Employees State Insurance Act :

Contractor agrees to and does hereby accept full and exclusive liability for compliance with all obligations imposed by the Employees' State Insurance Act 1948, and Contractor further agree to defend, indemnify and hold owner harmless from any liability or penalty which may be imposed by the Central or State Government of Local authority by reasons of any asserted violation by contractor or Sub-Contractor of the Employees' State Insurance Act, 1948 and also from all claims, suits or proceedings that may be brought against owner arising tender, growing out of or by reasons of the work provided for by this contract whether brought by employees of Contractor, by third parties or by Central or State Government authority or any administrative Sub-division thereof. Contractor agrees to fill in with the Employees State Insurance



Corporation, the declaration from and all forms which may be required in respect Contractor's or Sub-contractor's employees these aggregate remuneration is Rs. 400/-p.m.or less and who are employed in work provided for or those covered by E.S.I from time to time under the agreement. The Contractor shall deduct and secure the agreement of the Sub-contractor to deduct the employees' contribution as per the first Schedule of the Employees' State Insurance Act from wages. Contractor shall remit and secure the agreement of Sub-contractor to remit to the State Bank of India Employees' State Insurance Corporation Accounts, the employees contribution as required by the Act Contractor agrees to maintain all cares and record as required under the Act in respect of employees and payments and contractor shall secure the agreements of the sub-contractors to maintain such records, any expenses incurred for the contributions or maintaining records shall be to contractor's or sub- contractor' account. Owner shall retain such sum as may be necessary from the contract value until contractor shall furnish satisfactory proof that all contribution as required by the Employees' State Insurance Act 1948 have been paid.

2. Workman's Compensation And Employees Liability Insurance :

Insurance shall be effected for all contractors employees engaged in the performance of this contract. If any part of work is sublet, contractor shall require the sub-contractor to provide workmans' compensation and employer's liability insurance which may be required by owner.

3. Other Insurance required under law or regulation by owner :

Contractor shall also carry and maintain any and all other insurance which may be required under any law or regulation from time to time. He shall also carry and maintain any other insurance which may be required by owner.

#### GC-86 DAMAGE TO PROPERTY :

1. Contractor shall be responsible for making good to the satisfaction of owner any loss of and any damage to all structures and properties belonging to owner or being executed or Procured by owner or of other Agencies within the premises of all work of owner, if such loss or damage is due to fault and / or the negligence or will full act or omission of contractor, his employees, agent representatives or Sub- contractors.

2. Contractors shall indemnify and keep owner harmless of all claims for damage to properties other than S.M.C's property arisign under or by reasons of this agreement if such claims result from the fault and / or negligence or wilful act of omission of contractor,his employees, agents, representatives or sub-contractors.

#### GC-87 LABOUR LAWS AND REGULATIONS :

1. The contractor shall be reponsible for the strict compliance of and shall ensure strict compliance by his sub contractor employees and agents of all labours and others laws, rules or regulations having the force of law affecting the relationship of employer and employee between the contractor/ sub-contractor and their respective employees.

2. No labour below the age of eighteen (18) year be employed on work.

3. Contractor shall pay to the labours engaged on work according the law.

4. The Contractor and sub-contractors o f the contractor shall obtain proper authority disignated in this behalf under any application law, rules or regulations (including but not restricted to the factories Act and Contract Labour Abolition and Regulation Act 1970, ) in so far as applicable) any and all such licences, consents, Registration and / or other authorisation as shall from time to time be or become necessary for relatint to the execution of work or any part of portion thereof or the storage or supply of any materials or otherwise in connection with the performance of the contract and shall at all times observance by the sub- contractors, employees and agents of all terms and conditions of the said licences,consents, regulation and other authorisa- tion and laws, rules and regulations applicable thereto.

#### GC-88 CONTRACTOR TO INDEMNIFY OWNER :

1. The Contractor shall indemnify and keep indemnified the owner and every member, officer and employee of owner from and against all action, claims, demands and liabilities whatsoever and in respect of the breach of any of the above clauses and/or against any claim, action or demand by any workman/ employee of the contractor or any sub-contractor and or from any liability and way to any workman / employee of the contractor or any sub-contractor under any law, rule or regulations having the force of law, including but not limited to claims against the owner under the workman compensation Act 1923. The employees' Provident Funds Act 1952 and/or the Contract Labour (Abolition and Regulations) Act, 1970.

2. Payment of claims and damages :

If owner has to pay any money in respect of such claims or demands as aforesaid, the amount so paid and the cost incurred by the owner shall be charged to and paid by contractor without any dispute notwithstanding the same may have been paid without the consent or authority of the Contractor.

3. In every case in which by virtue of any provision applicable in the workman's Compensation Act 1923 or any other Act, be obliged to pay compensation to workman employed by Contractor the amount of compensation so paid, and without prejudice to the rights of S.M.C. under sec.(12) Sub-section (2) of the said Act, S.M.C. shall be at liberty to recover such amount from any surplus due to the contractor or the security deposit. S.M.C. will not be bound to contest any claim made under section (12) Sub-section (2) of the said Act except or written request of Contractor and upon the contesting of such claim.



4. The Contractor shall protect adjoining sites against structural decorative and other damages that could be caused to adjoining premises by the execution of these works and made good at his cost, any such damage, so caused.

**GC-89 IMPLEMENTATION OF APPRENTICE ACT 1964 :**

Contractor shall comply with the provisions of the Apprentice Act 1964 and the orders issued thereunder from time to time. If he fails to do so, it will be a breach of contract. Contractor shall also be liable for any particular liability arising on account of any violation of the provisions of the Act by him.

**GC-90 HEALTH AND SANITARY ARRANGEMENTS FOR WORKERS :**

Contractor shall comply with all the rules and regulations of the local sanitary authorities or as framed by owner from time to time for the protection of health and sanitary arrangements of all labour directly or indirectly employed on the work of this contract.

**GC-91 SAFETY CODE :**

**GENERAL :**

Contractor shall adhere to safe construction practice and guard against hazardous and unsafe working conditions and shall comply with owner's safety rules and set forth herein.

**1. First Aid and Industrial Injuries :**

1.1 Contractor shall maintain first aid facilities for its employees and those of his sub-contractor.

1.2 Contractor shall make outside arrangements for ambulance service and for the treatment of industrial injuries. Name of those providing these services shall be furnished to Engineer-in-charge prior to start of construction, and their telephone numbers shall be prominently posted in contractor's field office.

1.3 All injuries shall be reported promptly to Engineer-in-charge, and a copy of Contractor's report covering each personal injury requiring the attention of a physician shall be furnished to owner.

**2. General Rules :**

2.1 Carrying, striking, matches, lighters inside the project area & smoking within the job site is strictly prohibited. Violators of smoking rules shall be discharged immediately. Within the operation area, not hot work shall be permitted without valid gas safety, fire permits. The Contractor shall also be held liable and responsible for all lapses of his sub-contractors/ employees in this regard.

**3. Scaffolding :**

3.1 Suitable scaffolding shall be provided for workmen for all works that can not safely be done from the ground or from solid construction except such short period work as can be done safely from ladders. When a ladder is used, an extra mazdoor shall be engaged for holding the ladder and if the latter is used for carrying materials as well, suitable foothold and handholds shall be provided on the ladder and the same shall be given inclination not steeper than 1 to 4 (1 horizontal and 4 vertical).

3.2 Scaffolding or staging more than 3.6 M (12') above the ground or floor, swing or suspended from an overhead support or erected with stationary support shall have a guard rail properly attached, bolted, braced and otherwise fixed at least 1.0 M (3') high above the floor or platform of scaffolding or staging and extending along the entire length of the outside ends thereof with only such openings as may be necessary for the delivery of materials. Such scaffolding or staging shall be so fastened as to prevent it from swaying from the building or structure.

**4. Maintenance of Safety Devices :**

4.1 All scaffolds, ladders and other safety devices mentioned or described herein shall be maintained in some conditions and no scaffold, ladder or equipment shall be altered or removed while it is in use. Adequate washing facilities should be provided at or near place or work.

**5. Display of Safety Instructions :**

5.1 These safety provisions should be brought to the notice of all concerned by display on a notice board at a prominent place at the work-spot. The person responsible for compliance of the safety code shall be named therein by the Contractor.

**6. Enforcement of Safety Regulations :**

6.1 To ensure effective enforcement of the rules and regulations relating safety precautions, the arrangements made by the contractor shall be open to inspection by the welfare Officer, Engineer-in-charge of safety Engineer of the owner or their representatives.

**7. No Exemption :**

7.1 Notwithstanding the above clause 1.0 to 13.0 there is nothing to exempt the contractor from the operations of any other Act or rules in force in the Republic of India.

7.2 In addition to the above, the Contractor shall abide by the safety code provision as per C.P.W.D. Safety Code framed from time to time.

**GC-92 ACCIDENTS :**

It shall be the contractor's responsibility to protect against accidents on the work. He shall indemnify the Municipal Corporation against any claim for damage or for injury to persons or property resulting from, and in the course of work and also under the provision of the Workman's Compensation Act. On the occurrence of an accident arising out of the



works which results in death or which is so serious as to be likely to result in death, the contractor shall within twenty four hours of such accident, report in writing to the Engineer-in-charge, the facts stating clearly and in sufficient details the circumstances of such accident and the subsequent action. All other accidents on the works involving injuries to persons or damage to property other than that of the contractors shall be promptly reported to the Engineer-in-charge stating clearly and in sufficient details and facts and circumstances of the accidents and the action taken. In all cases the contractor shall indemnify the Municipal Corporation against all loss of damage resulting directly or indirectly from the Contractor's failure to report in the manner aforesaid. This includes penalties or fine consequence of failure to give notice under the workman's compensation Act or failure to conform to the provisions of the said Act in regard to such accidents.

In the event of an accident in respect of which compensation may become payable under the workmen's compensation Act VIII of 1923 including all modification thereof whether such compensation may become payable by the contractor or by the Municipal Corporation as principal employer, the Engineer-in-charge may retain out of money due and payable to the contractor such sum or sums of money as may, in the opinion of the Engineer-in-charge be sufficient to meet such liability. On receipt of award from the labour commission in regard to quantum of compensation, the difference in amount will be adjusted.

GC-93 It is clarified that if the contractor makes his own arrangements for water required for construction and labour camp etc. by drilling bore. No water charges will be recovered from the contractor. On the other hand, even if the contractor is not taking connection and makes other arrangement to use Municipal water by tanker or tapping water from near private connection even so water charges shall be recovered as per relevant condition of the tender.

**GC-93 (A) PRICE VARIATION CLAUSE:**

No PRICE VARIATION difference will be paid to the contractor for Labour, Materials, P.O.L. (Fuel) or any other material for the work

**GC-93 (B) STAR RATE & DIFFERENCE FOR REINFORCEMENT STEEL & CEMENT:**

No star rate or basic rate difference will be paid to the contractor for cement, steel reinforcement or any other material for the work

**GC-94 GOODS AND SERVICE TAX (GST):**

GST (Goods and Service Tax) has come in existence from 1<sup>st</sup> July, 2017. Contractor/ Successful Bidder is bound to pay any amount of GST prescribed by the Govt. of India as per the terms of Contract agreed upon during the course of execution of this contract.

During the execution of contract, if there is any change in rate of GST (Goods & Service Tax) by the Government, the same shall be reimbursed / recovered separately by SMC, subject to the submission of original receipt / proof for the amounts actually remitted by the successful tenderer / Contractor to the competent authority along with a certificate from chartered accountant of contractor / successful bidder certifying that the amount of GST paid to the Government and the same shall be intimated / submitted / claimed within 30 (Thirty) days from the date of payment. Remittance of GST within stipulated period shall be the sole responsibility of the successful bidder / Contractor, failing which, SMC may recover the amount due, from any other payable dues with SMC and decision of Municipal Commissioner shall be final and binding on the Contractor / Successful Bidder in this regard. Further, the non-payment of GST to the Government may lead to the termination of contract and forfeiture of Security Deposit / Performance Guarantee amount.

If imposition of any other new taxes / Duties / Levies / Cess or any other incidentals etc. or any increase in the existing Taxes / Duties / Levies / Cess or any other incidentals etc. (Excluding GST) are imposed during the course of the contract, in no case SMC shall be liable for the same.

The Contractor will submit the invoice to the SMC having GSTIN of SMC mentioned therein and the taxes shall be shown separately on the face of the invoice so as to claim as ITC by SMC.

EXECUTIVE ENGINEER,  
SOUTH ZONE (UDHNA)  
SURAT MUNICIPAL CORPORATION,

SIGNATURE OF THE CONTRACTOR



**SCHEDULE – A****ADDITIONAL INSTRUCTION FOR CEMENT AND STEEL :**

Surat Municipal Corporation shall not issued cement and reinforcement steel to be used for this work.

The cement and reinforcement steel required for the above said work shall be procured by contractor at its own cost. The brands for cement shall be **Ultratech, Sanghi, Hathi, Sidhhi, JK Laxmi** company confirming to IS-12269/87 latest amendment ISO-9000 of 53 grade OPC only.

Approved make of TMT reinforcement steel :- **TATA, SAIL, Rastriya Ispat, Electrotherm(ET), National, MONO** as confirming to IS 1786 : 2008(with latest amendments and edition) TMT Fe-415/Fe-500. TMT Steel shall be purchased by only manufacturing company/Authorised dealer/ Distributor/ Stockist only shall be allowed to use 6 mm plain steel shall be as per IS 2062/99 with latest emendment of any brand/make.

Any of the above mentioned brands of Cement and Reinforcement steel shall only be used by the contractor at the time of execution.

The brands for structural steel to be used shall be of make **TATA, Jindal, SAIL or Asian**.

All structural steel shall conform to I.S. 226-1975. The steel shall be free from the defects mentioned in I.S. 226- 1975 and shall have a smooth finish. The material shall be free from loose mill scale, rust pits or other defects affecting the strength and durability. Rivet bars shall conform to I.S. 1148-1992.

When the structural steel is supplied by the contractor test certificates of the manufacturers shall be obtained according to I.S. 226-1975 and other relevant Indian Standards.

Coloured galvanized Roofing sheet shall be of **TATA or Jindal** make trafford sheet

**WASTAGE OF CEMENT AND REINFORCEMENT STEEL :**

As the contractor is to bring the cement and steel, the question of considering the wastage on the basic of issue rate does not arise i.e. no separate payment shall be made for any kind of wastage in the materials. The payment for reinforcement bar will be made on theoretical weight basis. The weight shall be computed on the basis of the length of the steel used in the work multiplied by the standard unit weight of MS/HYSD/TMT bar as mentioned in IS code No.1786.

The steel consumption less than 7.5% of the standard consumption shall be penalised either at the double existing corporation issue rate or the prevailing market rate, whichever is more. Currently corporation Issue rate of TMT Steel is Rs. 43,000/- per M.T.

Similarly, for cement also, the less consumption beyond 5% shall be penalised at the double existing corporation issue rate or the prevailing market rate, whichever is more. Currently corporation Issue rate of Cement is Rs. 5,300/- per M.T.

**TESTING OF CEMENT AND STEEL :**

It should be specifically noted that the cement and steel brought by the contractor at site of work shall be used only after the same is tested at the approved laboratory as per the direction of the Engineer- in-charge. Such approved laboratory may be located at Surat, Baroda, Ahmedabad or Mumbai.

All the charge for the transport and testing of the samples shall have to be borne by the contractor. The frequency of testing such material shall be in accordance to the relevant Indian Standards as directed by Engineer-in-charge.

EXECUTIVE ENGINEER,  
SOUTH ZONE (UDHNA),  
SURAT MUNICIPAL CORPORATION

Signature of the Contractor:





## MEMORANDUM

1.	General Description of work	:	<b>CONSTRUCTION OF INNOVATION, INCUBATION, START UP AND TRADE FACILITATION CENTRE UNDER SMART CITY MISSION (PHASE-1) AT EXISTING SEPC BUILDING AT T.P. SCHEME NO.1 (UDHNA-MAJURA), F.P. NO.79 IN SOUTH ZONE (UDHNA), SURAT</b>
2.	Estimated Cost	:	<b>Rs. 2,89,01,429.33</b>
3.	Earnest Money Deposity	:	<b>Rs. 2,89,500.00</b>
4.	Additional Security Deposit (i) Cash (not less than the amount of earnest money)	:	Rs. 2% of Tender Amount.
	(ii) To be deducted for current bills	:	--
	Total Deposit	:	Rs. 2% of Tender Amount
5.	Time allowed for the completion of work from date fixed in written order to commence	:	<b>06 (Six) Months(Excluding monsoon)</b>
6.	Compensation for delayed work under GC 20A	:	Zero Point two percent (0.2%) of the contract price per day maximum upto ten percent (10%) of the contract price.
7.	The progress of work should confirm to the following schedule		
	10% of the work in	:	25% of the time.
	40% of the work in	:	50% of the time.
	70% of the work in	:	75% of the time.
	100% of the work in	:	100 % of the time
8.	<b>Percentage to be retained from running Account Bills</b>	:	<b>7% (Seven Percent)</b>
9.	Defect Liability Period	:	12 (Twelve) Months From the actual date of completion of work.
10.	Water Charges	:	<b>CONDITION FOR THE WATER SUPPLY &amp; ELECTRIC SUPPLY on next page.</b>
12.	Construction Cess will be deducted from respective R.A. Bill and Final bill in accordance with the prevailing norms of Govt. of Gujarat.	:	1% of Work Done Amount in R.A.Bills and Final Bill
13	<b>Goods and Service Tax (GST)</b>		<b>As per GC 94</b>

EXECUTIVE ENGINEER  
SOUTH ZONE (UDHNA)  
SURAT MUNICIPAL CORPORATION

Signature of the Contractor:



SURAT MUNICIPAL CORPORATION  
SOUTH ZONE (UDHNA)  
CONDITION FOR THE WATER SUPPLY & ELECTRIC SUPPLY

**FOR WATER CHARGE (As per City Engineer Note No.386, dtd.30/7/2012)**

**In case of Municipal Network or distribution center available or not at nearby area**

**OPTION-1:**

Contractor has to make his own arrangement for construction work whether from private boring or tankers. Contractor has to submit test report of water whether it is of good quality for construction work or not and contractor has to inform about it within 30 days of starting the work. If the contractor makes his own arrangement for water required for construction and labour camp etc. by drilling own bore or tankers, no water charges will be recovered from the contractor.

**OPTION-2:**

**If contractor wants to use Municipal Water he has to follow procedure within below:**

1. Contractor has to apply for water connection by Municipal Licenced plumber in prescribed form.
  2. Contractor has follow all procedure with his own expenses.
  3. According to rule Municipal Corporation issue bill to contractor for consumption of water and contractor has to paid it within stipulated time and contractor has submit one copy of bill and payment receipt to concern department. If contractor fail to pay the bill the amount of bill/paid receipt can be recover from contractor's bill.
  4. If Municipal Corporation network is not available then Contractor can make arrangement of water tanker from nearby distribution center after depositing required amount.
  5. After completion of work contractor has to can-celled the water connection and inform the concern department.
  6. If network and distribution center/network are both not available in that case contractor has to make his own arrangement for good quality construction water and has to follow the option-1.
  7. if contractor is taking water connection or even if the contractor is not taking connection and makes other arrangement to use Municipal Water by tanker or tapping water from near private connection, water charges shall be recovered at the rate of **3% (Three Percent)** of the civil items in which water consumed.
- (2) The contractor shall make his own arrangement at his cost for electric supply required for operating various plants and machineries required for the works and for general lighting purpose for site, office, labour colony etc.

The energy bills shall also be paid by the contractor.

EXECUTIVE ENGINEER,  
SOUTH ZONE (UDHNA)  
SURAT MUNICIPAL CORPORATION,

SIGNATURE OF THE CONTRACTOR.



IMPORTANT INSTRUCTION-A TO THE CONTRACTOR

- (1) This tender document containing Page No. **01 to 156** duly signed by the tenderer, should be furnished to Corporation treasury along with the amount of earnest money deposit as mentioned in tender notice. If any of the drawings or papers removed from the tender, the tender shall be rejected and E.M.D. shall be forfeited.
- (2) The tenderer who wants to propose something in written, he should write it on his letter pad or another paper. Anything written on tender papers shall not be considered by Corporation and Contractor shall not be intend to do so.
- (3) Following Certificate shall be enclosed with tender.
  - (a) Solvency Certificate amounting of 20% of tender amount.
  - (b) Registration Certificate of required class given by Government or Semi-Government organisation.
  - (c) List of work done by Contractor with its volume.

EXECUTIVE ENGINEER,  
SOUTH ZONE (UDHNA)  
SURAT MUNICIPAL CORPORATION,

SIGNATURE OF THE CONTRACTOR.



IMPORTANT INSTRUCTION-B TO TENDERER

1.

Affix Latest Passpost Size Photo of tenderer

\_\_\_\_\_  
Specimen Signature of the Bidder.

[2] AFFIX LATEST PASSPORT SIZE PHOTOGRAPH OF ALL PARTNERS IN CASE OF PARTNERSHIP AGENCY.

1	2	3	4
---	---	---	---

Specimen Signature of all partners incase of partnership agency.

1. \_\_\_\_\_
2. \_\_\_\_\_
3. \_\_\_\_\_
4. \_\_\_\_\_

Submission of Registered Agreement is compulsory in case of partnership agency.

3. Submission of income tax clearance certificate of last three years is complusery for tenderer submitting agency.
4. Submission of sale tax certificate, with proof of residence is compulsory for tenderer.
5. In case of Government royalty applicable to tenderer, it is compulsory to submit a receipt of royalty payment with tender.
6. The Photograph and specimen signature of contractor will be cross checked, whenever contractor receives payment in account section of SMC.
7. The specimen signature of contractor will be cross checked by account office of SMC, in case of representative of Contractor alongwith letter of authority of a person who signed an agreement, receives payment.
8. In case of octroi applicable to the goods of supplier/tenderer, the tenderer/suppler has to submit an attested copies of Xerox of all octroi receipts.

EXECUTIVE ENGINEER,  
SOUTH ZONE (UDHNA)  
SURAT MUNICIPAL CORPORATION

SIGNATURE OF THE CONTRACTOR.

**SPECIFICATIONS OF MATERIALS**

**M-1 WATER :**

- 1.1 Water shall not be salty or brackish and shall be clean, reasonably clear and free from objectionable quantities of silt and traces of oil and injurious alkalies, salts, organic matter and other deleterious material which will either weaken the mortar or concrete or cause efflorescence or attack the steel in R.C.C. Container for transport, storage and handling of water shall be clean. Water shall conform to the standards specified in I.S. 456-2000.
- 1.2 If required by the Engineer-in-charge it shall be tested by comparison with distilled water. Comparison shall be made by means of standard cement tests for soundness, time of setting and mortar strength as specified in I.S. 269-1989. Any indication of unsoundness, change in time of setting by 30 minutes or more or decrease of more than 10 percent in strength of mortar prepared with water sample when compared with the results obtained with mortar prepared with distilled water shall be sufficient cause for rejection of water under test.
- 1.3 Water for curing mortar, concrete or masonry should not be too acidic or too alkaline. It shall be free of elements which significantly affect the hydration reaction or otherwise interfere with the hardening of mortar or concrete during curing or those which produce objectionable stains or other unsightly deposits on concrete or mortar surfaces.
- 1.4 Hard and bitter water shall not be used for curing.
- 1.5 Portable water shall generally be found suitable for curing mortar or concrete.

**M-2 LIME :**

- 2.1 Lime shall be hydraulic lime as per I.S. 712-1984. Necessary tests shall be carried out as per I.S. 6932 (Parts I to X) 1995.
- 2.2 The following field tests for limes are to be carried out ---
  - a) A very rough idea can be formed about the type of lime by its visual examination i.e. fat lime bears pure white colour, lime in form of porous lumps of dirty white colour, indicates quick lime, and solid lumps the unbrunt lime stone.
  - b) Acid tests for determining the carbonate content in lime. Excessive amount of impurities and rough determination of class of lime.
- 2.3 Storage shall comply with I.S. 712-1984. The slaked lime, if stored, shall be kept in a weather proof and damp proof shed with impervious floor and sides to protect it against rain, moisture, weather and extraneous materials mixing with it. All lime that has been damaged in any way shall be rejected and all rejected materials shall be removed from site of work.
- 2.4 Field testing shall be done according to I.S. 162-1989 to show the acceptability of materials.

**M-3 CEMENT :**

- 3.1 Cement shall be ordinary portland slag cement as per I.S. 269-1989 or Portland slag cement as per I.S. 455-1976 and revised latest I.S.

**M-4 WHITE CEMENT :**

- 4.1 The white cement shall conform to I.S. 8042-1989.

**M-5 COLOURED CEMENT :**

- 5.1 Coloured cement shall be with white or grey portland cement as specified in the item of the work.
- 5.2 The pigments used for coloured cement shall be of approved quality and shall not exceed 10% of cement used in the mix. The mixture of pigment and cement shall be properly ground to have a uniform colour and shade. The pigments shall have such properties as to provide for durability under exposure to sun-light and weather.
- 5.3 The pigment shall have the property such that it is neither affected by the cement nor detrimental to it.

**M-6 SAND :**

- 6.1 Sand shall be natural sand, clean, well graded, strong, durable and gritty particles free from injurious amounts of dust, clay, kankar nodules, soft or flaky particles, shale, alkali, salts, organic matter, loam, mica or other deleterious substances and shall be got approved from the Engineer-in-charge. The sand shall not contain more than 8% of silt as determined by field tests. If necessary the sand shall be washed to make it clean.
- 6.2 Coarse Sand : The fineness modulus of coarse sand shall not be less than 2.5 and shall not exceed 3.0. The sieve analysis of coarse sand shall be as under ---

I.S. Sieve Designation	% by weight passing sieve	I.S. Sieve Designation	% by weight passing sieve
4.55 mm	100	600 Micron	30-100
2.36 mm	90-100	300 Micron	5-70
1.18 mm	70-100	150 Micron	0-60

- 6.3 Fine Sand : The fineness modulus shall not exceed 1.0. The sieve analysis of fine sand shall be as under ---

I.S. Sieve Designation	% by weight passing sieve	I.S. Sieve Designation	% by weight passing sieve
4.55 mm	100	600 Micron	40-85
2.36 mm	100	300 Micron	5-50
1.18 mm	75-100	150 Micron	0-10

**M-7 STONE DUST :**

- 7.1 This shall be obtained from crushing hard black tray or equivalent, it shall not contain more than 8% of silt as determined by field test with measuring cylinder. The method of determining silt contents by field test is given as under.
- 7.2 A sample of stone dust to be tested shall be placed without drying in 200 mm measuring cylinder. The quantity of the sample shall be such that it files the cylinder upto 100 mm mark. The clean water shall be added upto 150 mm mark. The mixture shall be stirred vigorously and the content allowen to settle for 3 hours.
- 7.4 The height of silt visible as settled layer above the stone dust shall be expressed as percentage of the height of the stone dust below. The stone dust containing more than 8% silt shall be washed so as to bring the silt content within the allowable limit.
- 7.5 The fineness modulus of stone dust shall not be less than 1.80.

**M-8 STONE GRIT :**

- 8.1 Grit shall consist of crushed or broken stone and be hard, strong, dense, durable, clean, of proper gradation and free from skin or coating likely to prevent proper adhesion of mortar. Grit shall generally be cubical in shape and as far as possible flaky elongated pieces shall be avoided. It shall generally comply with the provisions of I.S. 383-1990. Unless a special stone of a particularly quarry is metnioned, grit shall be obtained from the best black trap or equivalent hard stone as approved by the Engineer-in-charge. The grit shall have no deleterious reaction with cement.

8.2 The grit shall conform to the following gradation as per sieve analysis :

I.S. Sieve Designation	% by weight passing sieve	I.S. Sieve Designation	% by weight passing sieve
12.50 mm	100%	4.75 mm	2.20%
10.00 mm	80-100%	2.36 mm	0.25%

- 8.3 The crushing strength of grit will be such as to allow the concrete in which it is used to build-up the specified strenght of concerte.
- 8.4 The necessary tests for grit shall be carried out as per the requirements of I.S. 2338 (Parts I to VIII) 1988, as per instruction of the Engineer-in-charge. The necessity of test will be decided by the Engineering-in-charge.

**M-9 CINDER :**

- 9.1 Cinder is well brunt furnace residue which has been fused or ssintered into lumps of varying sizes.
- 9.2 Cinder aggregates shall be well burnt furnace residue obtained from furnace using coal fuel only. It shall be sound clead and free from clay, dirt, ash or other deleterious matter.
- 9.3 The average grading for cinder aggregates shall be as mentioned below :
- |         |     |
|---------|-----|
| 20 mm   | 100 |
| 10 mm   | 86  |
| 5.75 mm | 70  |
| 2.36 mm | 52  |

**M-10 LIME MORTAR :**

- 10.1 LIME : Shall conform to specification M-2. WATER : Water shall conform to specification M-1. SAND : Sand shall conform to specification M-6.
- 10.2 PROPORTION OF MIX Mortar shall consist of such proportions of slaked lime and sand as may be specified in the item. The slaked lime and shall shall be measured by volume.
- 10.3 PREPARATION OF MORTAR Lime mortar shall be prepared by wet process as per I.S. 1625-1971. Power driven mill shall be used for preparation of lime mortar. The slaked lime shall be placed in the mill in an even layer and ground for 180 revolutions with sufficient water. Water shall be added as required during grinding (care being taken not to add more water) that will bring the mixed material to a consistency of stiff paste. Thoroughly wetted sand shall then be added evenly and the mixture ground for another 180 revolutions.
- 10.4 STORAGE : Mortar shall always be kept damp, protected from sun and rain till used up, covering it by trapaulin or open sheds.
- 10.5 USE:All mortar shall be used as soon as possible after grinding. It should be used on the day on which it is prepared. But in no case mortar made earlier than 36 hours shall be permitted for use.

**M-11 CEMENT MORTAR :**

- 11.1 Water shall conform to specification M-1. Cement shall conform to specification M-3. Sand shall conform to M-5.
- 11.2 PROPORTION OF MIX : 11.2.1 Cement and sand shall be mixed to specified proportions, sand being measured by measuring boxes. The proportion of cement shall be by volume on the basis of 50 Kg./Bag of cement being equal to 0.0342 cu.m. The mortar may be hand mixed or machine mixed as directed.
- 11.3 PREPARATION OF MORTAR : 11.3.1 In hand mixed mortar, cement and sand in the specified proportions shall be thoroughly mixed dry on a clean impervious platform by turning over atleast 3 times or more till a homogeneous mixture of uniform colour is obtained. Mixing platform shall be so arranged that no deleterious extraneous material shall get mixed with mortar or mortar shall flow out. While mixing, the water shall be gradually added and thoroughly mixed to form a stiff plastic mass of uniform colour so that each particle of





sand shall be completely covered with a film of wet cement. The water cement ratio shall be adopted as directed.

- 11.4 The mortar so prepared shall be used within 30 minutes of adding water. Only such quantity of mortar shall be prepared as can be used within 30 minutes.

**M-12 STONE COARSE AGGREGATE FOR NOMINAL MIX CONCRETE :**

- 12.1 Coarse aggregate shall be of machine crushed stone of black trap or equivalent and be hard, strong, dense, durable, clean and free from skin and coating likely to prevent proper adhesion of mortar.
- 12.2 The aggregate shall generally be cubical in shape. Unless special stones of particular quarries are mentioned aggregates shall be machine crushed from the best black trap or equivalent hard stone as approved. Aggregate shall have no deleterious reaction with cement. The size of the coarse aggregate for plain cement concrete and ordinary reinforced cement concrete shall generally be as per the table given below. However, in case of reinforced cement concrete the maximum limit may be restricted to 6 mm. less than the minimum lateral clear distance between bars or 6mm. less than the cover whichever is smaller.

**TABLE**

I.S. Sieve Designation	Percentage Passing for single sized aggregates of nominal size			I.S. Sieve Designation	Percentage Passing for single sized aggregates of nominal size		
	40 mm	20 mm	16 mm		40 mm	20 mm	16 mm
80 mm	-	-	-	12.5 mm	-	-	-
63 mm	100	-	-	10 mm	0.5	0.20	0.30
40 mm	80-100	100	-	4.75 mm	-	0.50	0.50
20 mm	0-20	85-100	100	2.75 mm	-	-	-
10 mm	-	-	85-100				

NOTE:- This percentage may be varied somewhat by the Engineer-in-charge when considered necessary for obtaining better density and strength of concrete.

- 12.3 The grading test shall be taken in the beginning and at the change of source of materials. The necessary tests indicated in I.S. 383-1990 and I.S. 456-2000 shall have to be carried out to ensure the acceptability. The aggregates shall be stored separately and handled in such a manner as to prevent the intermixing of different aggregates. If the aggregates are covered with dust, they shall be washed with water to make them clean.

**M-13 BLACK TRAP OR EQUIVALENT HARD STONE COARSE :**

- 13.1 Aggregate for Design Mix Concrete : Coarse aggregate shall be of machine crushed stone of black trap or equivalent hard stone and be hard, strong, dense, durable, clean and free from skin and coating likely to prevent proper adhesion of mortar.
- 13.2 The aggregates shall generally be cubical in shape, unless special stones of particular quarries are mentioned, aggregates shall be machine crushed from the best, black trap or equivalent hard stones as approved. Aggregate shall have no deleterious reaction with cement.
- 13.3 The necessary tests indicated in I.S. 383-1990 and I.S. 456-2000 shall have to be carried out to ensure the acceptability of the material.
- 13.4 If aggregate is covered with dust it shall be washed with water to make it clean.

**M-14 BRICK BATS AGGREGATE :**

- 14.1 Brick bat aggregate shall be broken from well burnt or slightly over burnt and dense bricks. It shall be homogeneous in texture, roughly cubical in shape, clean and free from dirt of any other foreign material. The brick bats shall be of 40 mm to 50 mm size unless otherwise specified in the item. The underburnt or overburnt brick bats shall not be allowed.
- 14.2 The brick bats shall be measured by volume by suitable boxes as directed.

**M-15 BRICKS :**

- 15.1 The bricks shall be hand or machine moulded and made from suitable soils and kiln burnt. They shall be free from cracks and flaws not nodules of free lime. They shall have smooth rectangular faces with sharp corners and shall be of uniform colour. The bricks shall be moulded with a frog of 100mm x 40 mm and 10mm to 20mm deep on one of its flat sides. The bricks shall not break when dropped on the ground from a height of 600 mm.
- 15.2 The size of modular bricks shall be 190mm x 90mm x 90mm.
- 15.3 The size of conventional bricks shall be as under ---  
225 x 110 x 75mm.
- 15.4 Only bricks of one standard size shall be used on one work. The following tolerances shall be permitted in the conventional size adopted in a particular work.  
Length : 3.00 mm  
Width : 1.50 mm  
Height : 1.50 mm



- 15.5 The crushing strength of the bricks shall not be less than 35 Kg./Sq.Cm. The average water absorption shall not be more than 20% by weight. Necessary tests for crushing strength and water absorption etc. shall be carried out as per I.S. 3495 (Part I to IV)-1992.

**M-15A FLYASH BUILDING BRICKS :**

The Flyash building bricks shall conform to Grade-5 of IS-13757. The frog of the 80 to 100 mm x 40 mm x 10 to 20 mm size.

The size of modular bricks shall be 190 mm x 90 mm x 90 mm.

The size of conventional brick shall be 230 mm x 110 mm x 70 mm.

Only bricks of one standard size shall used on one work. The following tolerances shall permitted in the conventional size adopted in a particular work:

Length :  $\pm$  4 mm

Width :  $\pm$  2 mm

Height :  $\pm$  2 mm

The physical characteristic of bricks shall be as follows.

The minimum compressive strength of Flyash building bricks shall not be less than 70 Kg/Sq.Cm. and the test shall be conform to IS-3495 (Part-I).

The averages water absorption not more than 20 percentage by weight and the test shall conform to IS-3495(Part-3). Sampling of Flyash building bricks and criteria for conformity shall be as per I.S.:5454.

**M-16 STONE :**

- 16.1 The stone shall be of the specified variety such as Granite/Trap stone/Quartzite or any other type of good hard stones. The stones shall be obtained only from the approved quarry and shall be hard, sound, durable and free from defects like cavities, cracks, sand holes, flaws, injurious viens, patches of loose or soft materials etc. and weathered portions and other structural defects or imperfections tending to affect their soundness and strength. The stone with round surface shall not be more than 5% of dry weight. When tested in accordance with I.S. 1134-1985. The minimum crushing of the strength of the stone shall be 200 Kg./Sq.Cm. unless otherwise specified.

- 16.2 The samples of the stone to be used shall be got approved before the work is started.

- 16.3 The khanki facing stone shall be dressed by chisel as specified in the item for khanki facing in required shape and size. The face of the stone shall be so dressed that the bushing on the exposed face shall not project by more than 40 mm. from the general wall surface and on face to be plastered it shall not project by more than 19 mm nor shall it have depressions more than 10 mm from the average wall surface.

**M-17 LATERITE STONE :**

- 17.1 Laterite stone shall be obtained from the approved quarry. It shall compacted in texture, sound, durable and free from soft patches. It shall have a minimum crushing strength of 100 Kg/Sq.Cm. in its dry condition. It shall not absorb water more 20% of its own weight, when immersed for 25 hours in water. After quarrying, the stone shall be allowed to weather for some time before using in work.

- 17.2 The stone shall be dressed into rectangular blocks so that all faces are from waviness and unevenness and the edges true and square.

- 17.3 Those type of stone in which white clay occurs should not be used.

- 17.4 Special corner stones shall be provided where so directed.

**M-18 MILD STEEL BARS/TMT/CRS BARS :**

- 18.1 Mild steel bars reinforcement TMT/CRS Bars for R.C.C. work shall conform to I.S. 432 (Part-II)-1982 and shall be of tested quality. It shall also comply with the relevant part of I.S. 456-1978 and revised latest I.S. Code.

- 18.2 All the reinforcement shall be clean and free from dirt, paint, grease, mill scale or loose or thick rust at the time of placing.

- 18.3 For the purpose of payment the bar shall be measured correct upto 10 mm length and weight payable worked out as per the rate specified below :

(i)	6 mm	0.22 Kg/Rmt.
(ii)	8 mm	0.39 Kg/Rmt.
(iii)	10 mm	0.62 Kg/Rmt.
(iv)	12 mm	0.89 Kg/Rmt.
(v)	14 mm	1.21 Kg/Rmt.
(vi)	16 mm	1.58 Kg/Rmt.
(vii)	18 mm	2.00 Kg/Rmt.
(viii)	20 mm	2.47 Kg/Rmt.
(ix)	22 mm	2.98 Kg/Rmt.
(x)	25 mm	3.85 Kg/Rmt.
(xi)	28 mm	4.38 Kg/Rmt.
(xii)	32 mm	6.32 Kg/Rmt.
(xiii)	36 mm	8.00 Kg/Rmt.
(xiv)	40 mm	9.86 Kg/Rmt

**M-19 HIGH YIELD STRENGTH STEEL DEFORMED BARS :**

- 19.1 High yield strength steel deformed bars shall be either cold twisted or hot rolled and shall conform to I.S. 1739-1978 and I.S. 1139-1966 respectively.
- 19.2 Other provision and requirements shall conform to specification No. M-18 for Mild Steel Bars.

**M-20 HIGH TENSILE STEEL WIRES :**

- 20.1 The high tensile wires for use in prestressed concrete shall conform to I.S. 2090-1983.
- 20.2 The tensile strength of the high tensile steel bars shall be as specified in the item. In absence of the given strength and minimum strength shall be taken as per para 6-1 of the I.S. 1785-1962. Testing shall be done as per I.S. requirements.
- 20.3 The high tensile steel shall be free from loose mill scale, rust, oil, grease or any other harmful matter. Cleaning of steel bars may be carried out by immersion in solvent solution, wire brushing or passing through a pressure box containing carborundum.
- 20.4 The high tensile wire shall be obtained from manufactures in coils having diameter not less than 350 times the diameter of wire itself so that wire springs back straight on being uncoiled.

**M-21 MILD STEEL BINDING WIRE :**

- 21.1 The mild steel wire shall be of 1.63mm or 1.22mm (16 or 18 gauge) diameter and shall conform to I.S. 280-1978.
- 21.2 The use of black wire will be permitted for binding reinforcement bars. It shall be free from rust, oil, paint, grease, loose mill scale or any other undesirable coating which may prevent adhesion of cement mortar.

**M-22 STRUCTURAL STEEL :**

- 22.1 All structural steel shall conform to I.S. 226-1975. The steel shall be free from the defects mentioned in I.S. 226-1975 and shall have a smooth finish. The material shall be free from loose mill scale, rust pits or other defects affecting the strength and durability. Rivet bars shall conform to I.S. 1148-1992.
- 22.2 When the steel is supplied by the contractor test certificates of the manufacturers shall be obtained according to I.S. 226-1975 and other relevant Indian Standards.

**M-23 GALVANISED IRON SHEETS :**

- 23.1 The galvanised iron sheets shall be plain or corrugated sheets of gauge as specified in item. The G.I. Sheets shall conform to I.S. 277-1992. The sheets shall be undamaged in carriage and handling either by rubbing off of zinc coating or otherwise. They shall have clean and bright surface and shall be free from dents, bends, holes, rust or white powdery deposit.
- 23.2 The length and width of G.I. sheets shall be as directed as per site condition.

**M-23-A G.I. VALLEYS GUTTER, RIDGES :**

- 23-A.1 The G.I. ridges and hips shall be of plain galvanised sheets class-3 of the thickness as specified in item. These shall be 600 mm width and properly bent up to shape without damage to the sheets in process of bending.
- 23-A.2 Valleys gutters and flashings shall be also of galvanised sheet of thickness as specified in item. Valleys shall be 900 mm. wide over all and flashing shall be 380 mm wide over all. They shall be bent to the required shape without damage to the sheet in the process of bending.

**M-24 ASBESTOS CEMENT SHEETS :**

- 24.1 Asbestos cement sheets plain, corrugated or semi-corrugated shall conform to I.S. 459-1970. The thickness of the sheets shall be as specified in the item. The sheet shall be free from all defects such as cracks, holes, deformities, chipped edges or otherwise damaged.
- 24.2 Ridges and Hips :
- 24.2.1 Ridges and hips shall be of same thickness as that of A. C. sheets. The types of ridges shall be suitable for the type of sheets and locations.
- 24.2.2 Other accessories to be used in roof such as flashing pieces, eaves filler pieces, valley gutters, north light and ventilator curves, barge boards etc. shall be of standard manufacture and shall be suitable for the type of sheets and location.

**M-25 MANGALORE PATTERN ROOF TILES :**

- 25.1 The Mangalore pattern tiles shall conform to I.S. 654-1992 for Class `AA' or `A' type as specified in item. Samples of the tiles to be provided shall be got approved from the Engineer-in-charge. Necessary tests shall be carried out as directed.

**M-26 SHUTTERING :**

- 26.1 The shuttering shall be either of wooden planking of 30mm minimum thickness with or without steel lining or of steel plates stiffened by steel angles. The shuttering shall be supported on battens and beams and props of vertical ballies properly cross bracked together so as to make the centering rigid. In places of ballie props, bricks pillar of adequate section built in mud mortar may be used.
- 26.2 The form work shall be sufficiently strong and shall have camber, so that it assumes correct shape after deposition of the concrete and shall be able to resist forces caused by vibration of concrete, live load of men working with it and other incidental loads associated with it. The shuttering shall have smooth and even surface and its joints shall not permit leakage of cement grout.
- 26.3 If at any stage of work during or after placing concrete in the structure, the form work sags or bulges out beyond the required shape of the structure, the concrete shall be removed and work redone with fresh concrete and



- adequately rigid form work. The complete form work shall be got inspected by and approved from the Engineer-in-charge, before the reinforcement bars are placed in position.
- 26.4 The props shall consist of bulgies having 100mm minimum diameter measured at mid length and 80mm at thin end and shall be placed as per design requirement. These shall rest squarely on wooden sole plates 40 mm. thick and minimum bearing area of 0-10 sq.m. laid on sufficiently hard base.
- 26.5 Double wedges shall further be provided between the sole plate and wooden props so as to facilitate tightening and easing of shuttering without jerking the concrete.
- 26.6 The timber used in shuttering shall not be so dry so as to absorb water from concrete and swell or bulge nor so green or wet so as to shrink after erection. The timber shall be properly sawn and planed on the sides and the surface coming in contact with concrete. Wooden form work with metal sheet lining or steel plates stiffened by steel angles shall be permitted.
- 26.7 As far as practicable, clamps shall be used to hold the forms together and use of nails and spikes avoided.
- 26.8 The surface of timber shuttering that would come in contact with concrete shall be well wetted and coated with soap solution before the concreting is done. Alternatively coat of raw linseed oil or oil of approved manufacture may be applied in place of soap solution. In case of steel shuttering either soap solution or raw linseed oil shall be applied after thoroughly cleaning the surface. Under no circumstances black or burnt oil shall be permitted.
- 26.9 The shuttering for beams and slabs shall have camber of 4mm per metre (1 in 250) or as directed by the Engineer-in-charge so as to offset the subsequent deflection. For cantilevers, the camber at free end shall be 1/50 of the projected length or as directed by the Engineer-in-charge.
- M-27 EXPANSION JOINTS - PREMOULDED FILLER :**
- 27.1 The item provides for expansion joints in R.C.C. frame structures for internal joints, as well as exposed joints, with the use of premoulded bituminous joint filler.
- 27.2 Premoulded bituminous joint filler, i.e. performed stirp of expansion joint filler shall not get deformed or broken by twisting, bending or other handling when exposed to atmospheric condition. Pieces of joint filler that have been damaged shall be rejected.
- 27.3 Thickness of the pre moulded joint filler shall be 25 mm unless otherwise specified.
- 27.4 Premoulded bituminous joint filler shall conform to I.S. 1838-1961.
- M-28 EXPANSION JOINTS - COPPER STRIPS AND HOLD FASTS :**
- 28.1 The item provides for expansion joints in R.C.C. frame structure for internal joints as well as for exposed joints with the use of necessary copper strip and holdfasts.
- 28.2 Copper sheet shall be 1.25 mm thick and of 1.25 mm with 'U' shape in the middle, copper strip shall have holdfast of 3 mm diameter copper rod fixed to the plate soldered on strip at intervals of about 30 cm. or as shown in the drawing or as directed. The width of each flange (horizontal side) of the copper plate to be embedded in the concrete work shall be 25 mm Depth of 'U' to be provided in the expansion joint, in the copper plate shall be of 25 mm.
- M-29 TEAK WOOD :**
- 29.1 The teak wood shall be of good quality as required for the item to be executed. When the kind of wood is not specifically mentioned, good Indian teak wood as approved shall be used.
- 29.2 Teak wood shall generally be free from large, loose, dead or cluster knots, flaws, warps, twists, shakes, bends or any other defects. It shall generally be uniform in substance and of straight fibres as far as possible. It shall be free from rot, decay, harmful fungi and other defects of harmful nature, which will affect the strength, durability or its usefulness for the purpose for which it is required. The colour shall be uniform as far as possible. Any effort like painting, using any adhesive or resinous materials made to hide the defects shall render the pieces liable to rejection by the Engineer-in-charge.
- 29.3 All scantlings, planks etc. shall be sawn in straight lines and planes in the direction of grains and of uniform thickness.
- 29.4 The tolerances in the dimensions shall be allowed at the rate of 1.5 mm per face to be planed.
- 29.5 First Class Teak Wood :  
First class teak wood shall have no individual hard and sound knots, more than 6 sq.cm. in size and the aggregate area of such knots shall not be more than 1% of area of piece. The timber shall be closed grained.
- 29.6 Second Class Teak Wood :  
No individual hard and sound knots shall be more than 15 sq.cm. in size and aggregate area of such knots shall not exceed 2% of the area of piece.
- M-29-A NON-TEAK WOOD :**
- The non teak wood shall be chemically treated, seasoned as per I.S. Specifications and of good quality. The type of wood shall be got approved before collecting the same on site. Fabrication of wooden members shall be started only after approval. For this purpose wood of Bio, Kalai, Sires, Saded, Behda, Jamun, Sisoo will be used for door frames whereas only Kalai, Siras, Halda, Kalam etc. will be permitted for shutters after proper seasoning and chemical treatment.
- The non teak wood shall be free from large, loose dead of cluster knots, flows, shakes, warps, bends, or any other defect. It shall be uniform in substance and of straight fibres as far as possible. It shall be free from



rots, decay, harmful fungi and other defects of similar nature which will affect the strength, durability or its usefulness for the purpose for which it is required. The colour of the wood shall be uniform as far as possible. The scantalings, planks etc. shall be sawn in straight lines and planes in the direction of grain and of uniform thickness.

The department will use the Agency to produce a certificate from the Forest Department in the event of a dispute and the decision of the Department shall be final and binding to the contractor.

The tolerance in the dimension shall be allowed at 1.5 mm. per face to be planed.

**M-30 WOODEN FLUSH DOOR SHUTTERS (SOLID CORE) :**

- 30.1 The solid core type flush door shutters shall be of decorative or non-decorative type as specified in the drawing. The size and thickness of the shutter shall be as specified in drawings or as directed. The timber species for core shall be used as per I.S. 2202-(Part-I)-1991. The timber shall be free from decay and insect attack. Knots and knot holes less than half the width of cross-section of the members, pitch streaks and harmless pin holes shall be permissible except in the exposed edges of the core members. The commercial plywood, cross bands shall conform to I.S. 303-1298.
- 30.2 The face panel of the shutters shall be formed by gluing by the hot press process on both faces of the core with either plywood or cross bands, and face veneers. The lipping, rebating, opening of glazing, venetion etc. shall be provided if specified in the drawing.
- 30.3 All edges of the door shutters shall be square. The shutters shall be free from twist or warp in its plane. Both faces of the shutters shall be sand papered to smooth even texture.
- 30.4 The shutters shall be tested for ---
- i] End Immersion Test : The test shall be carried out as per I.S. 2202 (Part-I) 1991. There shall be no delamination at the end of the test.
- ii] Knife Test : The face panel when tested in accordance with I.S. 1659-1990 shall pass the test.
- iii] Glue Adhesion Test : The flush door shall be tested for glue adhesive test in accordance with I.S. 2202(Part-I)-1991. The shutters shall be considered to have passed the test if no delamination occurs in the glue lines in the plywood and if no single delamination more than 80 mm. in length and more than 3 mm. in depth has occurred in the assembly glue lines between the plywood face and the style and rail. Delamination at the corner shall be measured continuously around the corner. Delamination at the knots knot, hole and other permissible wood defects shall not be considered in assessing the sample.
- 30.5 The tolerance in size of solid core type flush door as under:-  
In nominal thickness # 1.2 mm. In nominal height # 3 mm. The thickness of the shutters shall be uniform throughout with a permissible variation of not more than 0.8 mm. when measured at any two points.

**M-31 ALUMINIUM DOORS, WINDOWS, VENTILATORS :**

- 31.1 Aluminium alloy used in the manufacture of extruded window sections shall conform to I.S. designation HEA-WP of I.S.:733- 1991 and also to I.S. Designation WVG - WP OF I.S.:1285-1991. The sections shall be as specified the drawing and design. The fabrication shall be done as directed.
- 31.2 The hinges shall be cast or excluded aluminium hinges of same type as in window but or large size.
- 31.3 The hinges shall normally be of 50 mm projecting type non projecting type of hinges may also be used if directed. The handles of door shall be of specified design. A suitable lock for the door operable either from outside shall be provided. In double shutter door, the first closing shall have a concealed aluminium alloy bolt at top and bottom.

**M-32 ROLLING SHUTTERS :**

- 32.1 The rolling shutters shall conform to I.S. 6248-1991. Rolling shutters shall be supplied of specified type with accessories. The size of the rolling shutters shall be specified in the drawings. The shutters shall be constructed with interlocking lath sections formed from cold rolled steel strips not less than 0.9 mm. thick and 80 mm. wide for shutters upto 3.5 m. Width not less than 1.25 mm. thick and 80 mm. wide for shutters 3.5 m. in width and above unless otherwise specified.
- 32.2 Guide channels shall be of mild steel deep channel section and of rolled pressed or built up (fabricated) jointless construction. The thickness of sheet used shall not be less than 3.15 mm.
- 32.3 Hood covers shall be made of M.S. sheets not less than 0.92 mm. thick. For shutters having width 3.5 mts. and above, the thickness of M.S. sheet for the hood covers shall be not less than 1.25 mm.
- 32.4 The spring shall be of best quality and shall be manufactured from tested high tensile spring steel wire or strip of adequate strength to balance the shutters in position. The spring pipe shaft etc. shall be supported on strong M.S. or malleable C.I. brackets. The brackets shall be fixed on the or under the lintel as specified with rawl plugs and screws bolts etc.
- 32.5 The rolling shutters shall be of self rolling type upto 8 sq.m. clear area without ball bearing and upto 12 sq.m. clear area with ball bearing. If the rolling shutters are of larger then gear operated type shutters shall be used.
- 32.6 The locking arrangement shall be provided at the bottom of shutter at both ends. The shutters shall be opened from outside.
- 32.7 The shutters shall be completed with door suspension, shafts, locking arrangements, pulling hooks, handles and other accessories.



**M-33 COLLAPSIBLE STEEL GATE :**

33.1 The collapsible steel gate shall be in one or two leaves and size as per approved drawings or as specified. The gate shall be fabricated from best quality mild steel channels, flats etc. Either steel pulleys or ball bearings shall be provided in every double channel. Unless otherwise specified the particulars of collapsible gate shall be as under ---

- i] Pickets : These shall be of 20 mm. M.S. channels of heavy sections unless otherwise shown on drawings. The distance centre to centre of pickets shall be 12 cms. with an opening of 10 cms.
- ii] Pivoted M.S. flats shall be 20 mm. x 6 mm.
- iii] Top and bottom guides shall be from tee or flat iron of approved size.
- iv] The fittings like stoppers, fixing hold fasts, locking cleats, brass handles and cast iron rollers shall be of approved design and size.

**M-34 WELDED STEEL WIRE FABRIC:**

34.1 Welded steel wire fabric for general purpose shall be manufactured from cold drawn steel 'as drawn' or galvanised steel conforming to I.S. 226-1975 With longitudinal and transverse wire securely connected at every intersection by a process of electrical resistance welding and conforming to I.S. 4948-1974. It shall be fabricated and finished in a workman like manner and shall be free from injurious defects and shall be rust proof. The type of mesh shall be oblong or square as directed. The mesh sizes and sizes of wire for square as well as oblong welded steel wire fabric shall be as directed. The steel wire fabric in panels shall be in one whole piece in each panel as far as stock sizes permit.

**M-35 EXPANDED METAL SHEETS :**

35.1 The expanded metal sheets shall be free from flaws, joints, welds, broken, stands, laminations and other harmful surface defects Expanded metal steel sheet shall conform to I.S. 412 - 1992 except that blank sheets need not be with guaranteed mechanical properties. The size of the diamond mesh of expanded metal and dimensions of strands (width and thickness) shall be as specified. The tolerance on nominal weight of expanded metal sheets shall be of + 10 per cent.

35.2 Expanded metal in panels shall be in one whole piece in each panel as far as stock sizes permit. The expanded metal sheets shall be coated with suitable protective coating to prevent corrosion.

**M-36 MILD STEEL WIRE (Wire Gauze Jali) :**

36.1 Mild steel wire may be galvanised, as indicated. All finished steel wire shall be well cleanly drawn to the dimensions and size of wire as specified in item. The wire shall be sound, free from slits, surface flaws, rough jagged and imperfect edges and other harmful surface defects and shall conform to I.S. 280-1992.

**M-37 PLYWOOD :**

37.1 The Plywood for general purpose shall conform I.S. 303-1998. Plywood is made by cementing together thin boards or sheets of wood into panels. There are always an odd number of layers 3, 5, 7, 9 ply etc. The plies are placed so that the grain of each layer is at right angles to the grain in the adjacent layers.

37.2 The chief advantage of plywood over a single board of the same thickness is the more uniform strength of the plywood along the length and width of the plywood and greater resistance to cracking and slitting with change in moisture content.

37.3 Usually synthetic resins are used for glueing. Phenolic resins are usually cured in a hot press which compresses and simultaneously heats the plies between hot plates which maintain a temperature of 90 degree C. to 140 degree C. and a pressure of 11 to 14 Kg./Sq.cm. on the wood. The time of heating may be any thing from 2 to 60 minutes depending upon thickness.

37.4 When water glue are used the wood absorbs so much Water that the finished plywood must be dried carefully, When synthetic resins are used as adhesive the finished plywood must be exposed to atmosphere of controlled humidity until the proper amount of moisture has been absorbed.

37.5 According to I.S. : 303-1998 the plywood for general purpose shall be of three grades namely BWR.WWR and CWR depending upon the adhesives used for bonding the veneers and it will be further classified into six types namely AA, AB, AC, BB, BC and CC based on the quality of the two faces, each face being of three kinds namely A, B and C. After pressing, the finished plywood should be reconditioned to a moisture content not less than 8 percent and not more than 16 percent.

**TABLE****37.6 THICKNESS OF PLYWOOD BOARDS**

Board	Thich
3 ply	3 mm
	4 mm
	5 mm
	6 mm
6 ply	5 mm
	6 mm
	8 mm
	8 mm
	9 mm





7 Ply	9 mm
	13 mm
	16 mm
9 Ply	13 mm
	16 mm
	19 mm
11 ply	19 mm
	22 mm
	25 mm

**M-38 GLASS :**

38.1 All glass shall be of the best quality, free from specks, bubbles, smokes, veins, air holes blisters and other defects. The kind of glass to be used shall be as mentioned in the item or specification or in the special provisions or as shown in detailed drawings. Thickness of glass panes shall be uniform. The specifications for different kinds of glass shall be as under ----

## 38.2 Sheet Glass :

38.2.1 In the absence of any specified thickness or weight in the item or detailed specifications of the item of work, sheet glass shall be weighing 7.5 Kg./Sq.m. for panes upto 600 mm. x 600 mm.

38.2.2 For panes larger than 600 mm. x 600 mm. and upto 800 mm. x 800 mm. glass weighing not less than 8.75 Kg./Sq.m. shall be used. For bigger panes upto 900 mm. x 900 mm. glass weighing not less than 11.25 Kg./Sq.m. shall be used.

38.2.3 Sheet glass shall be patent flattened glass of best quality and for glazing and framing purposes shall conform to I.S. 761-1963. Sheet glass of the specified colours shall be used, if so shown on detailed drawings or so specified. For important buildings and for panes with any dimensions over 900 mm. plate glass of specified thickness shall be used.

## 38.3.0 Plate Glass :

38.3.1 When plate glass is specified it shall be "Polished Patent Plate Glass" of best quality. It shall have both the surface ground flate and parallel and polished to obtain clear undistured vision and reflection. The plate glass shall be of the thickness mentioned in the item or as shown in the detailed drawing or as specified. In the absence of any specified thickness, the thickness of plate glass to be supplied shall be 6 mm. and a tolerance of 0.20 mm. shall be admissible.

## 38.4.0 Obscured Glass :

38.4.1 This type of glass transmits light so that vision is partially or almost completely obscured. Glass shall be plain rolled, figured, ribbed or fluted, or frosted glass as may be specified as required. The thickness and type of glass shall be as per details on drawings or as specified or as directed.

## 38.5.0 Wired Glass :

Glass shall be with wire netting embedded in a sheet of plane glass. Electrically welded 13 mm. Geogain square mesh shall be used. Thickness of glass shall not be less than 6 mm. wired glass shall be of type and thickness as specified.

**M-39 ACRYLIC SHEETS :**

39.1 Acrylic sheets shall be of thickness as specified in the item and of a specified shape and size as the case may be. Panels may be flat or curved. It should be light in weight. It shall be colourless or coloured or opaque as specified in the item. Colourless sheet shall be as transparent as the finest optical glass. Its light transmission rate shall be about 95%. Transparency shall not be affected for the sheets of larger thickness. It shall be extremely resistant to sunlight, weather and low temperatures. It shall not show any significant yellowing or change in physical properties or loss of light transmission over a longer period of use.

The sheet shall be impact resistant also. Sheets should be available in complete range of standard transparent, translucent and opaque colours. Sheets should be available in complete range of standard transparent, translucent and opaque colours. Sheets shall be of such quality that they can be cut, bent and jointed as desired. Solution for the joints shall be used as per the requirement of manufacture.

**M-40 PARTICLE BOARD :**

40.1 The particle boards used for face panels shall of best quality free from any defects. The particle boards shall be made with phenolmaldehyde adhesive. The particle boards shall conform to I.S. 3087-1990. "Specification for wood particle board for general purpose." The size and the thickness of the particle board shall be as specified.

**M-41 EXPANDED POLYSTYRENE OR FRAMES STYROPER SLEBS :**

41.1 The expanded polystyrene ceiling boards and tiles shall be of approved make and shall be of size thickness, finish and colour and indicated. It shall be of high density and suitable for use as insulating material. The insulating material shall be like slab of thermocole etc.

**M-42 RESIN BONDED FIBRE GLASS :**

42.1 The resin bonded fibre glass tiles or rools shall be of approved make and shall be sizes, thickness and finish as indicated.



42.2 For test of Mineral wool thermal insulation Blanket I.S. 3144-1965 followed.

42.3 Insulation wool blanket shall be with the following coverings on one or both sides as indicated.

- (1) Bituminised jessian kraft paper suitable for use in position where moisture has to be excluded.
- (2) Hessain cloth or Kraft paper for keeping out dust.
- (3) G. I. wire netting, suitable or surfaces to be plastered over.

**M-43 FIXTURES & FASTENINGS :**

General ---

- i] The fixtures and fastenings, that is, butt hinges, tee and strap hinges, sliding door bolts, tower bolts, door latch, bath-room latch, handles, door stoppers, casement window fasteners, casement stays and ventilator catch shall be made of the metal as specified in the item or its specifications.
- ii] They shall be of iron, brass, aluminium, chromium plated iron, chromium plated brass, copper oxidised iron, copper oxidised brass or anodised aluminium as specified.
- iii] The fixtures shall be heavy, medium or light type. The fixtures and fastenings shall be smooth finished and shall be such as will ensure ease of operation.
- iv] The samples of fixtures and fastenings shall be got approved as regards quality and shape before providing them in position.
- v] Brass and anodised aluminium fixtures and fastenings shall be bright finished.

Holdfasts :

- i] Holdfasts shall be made from mild steel flat 30 cm. length and one of the holdfasts shall be bent at right angle and two nos. of 6 mm. dia. holes shall be made in it for fixing it to the frame with screws. At the other end, the holdfast shall be forked and bent at right angles in opposite directions.

Butt Hinges :

- i] Railway standard heavy type butt hinges shall be used when so specified.
- ii] Tee and strap hinges shall be manufactured from M.S. sheet.

Sliding Door Bolts (Aldrops) :

- i] The aldrops as specified in the item shall be used and shall be got approved.

Tower Bolts (Barrel Type) :

- i] Tower bolts as specified in the item shall be used and shall be got approved.

Door Latch :

- i] The size of door latch shall be taken as the length of latch.

Bathroom Latch :

- i] Bathroom latch shall be similar to tower bolt.

Handle :

- i] The size of the handles shall be determined by the inside grip length of the handles. Handles shall have a base plate of length 50 mm. more than the size of the handle.

Door Stoppers :

- i] Door stoppers shall be either floor door stopper type or door catch type. Floor stopper shall be of overall size as specified and shall have a rubber cushion.

Door Catch :

- i] Door catch shall be fixed at a height of about 900 mm. from the floor level such that one part of the catch is fitted on the inside of the shutter and other part is fixed in the wall with necessary wooden plug arrangements for appropriate fixity. The catch shall be fixed 20 mm. inside the face of the door for easy operation of catch.

Wooden Door Stop With Hinge :

- i] Wooden door stop of size 100 mm. x 60 mm. x 40 mm. shall be fixed on the door frame with a hinge of 75 mm. size and at a height of 900 mm. from the floor level. The wooden door stop shall be provided with 3 coats of approved oil paint.

Casement Window Fastener :

- i] Casement window fastener for single lead window shutter shall be left or right handed as directed.

Casement Stays (Straigot Peg.Stay) :

- i] The stays shall be made from a channel section having three holes at appropriate position so that the window can be opened either fully or partially as directed.  
Size of the stay shall be 250 mm. to 300 mm. as directed.

Ventilator Catch :

- i] The pattern and shape of the catch shall be as approved.

Pivot :

- i] The base and socket plate shall be made from minimum 3 mm. thick plate, and projected pivot shall not be less than 12 mm. dia. and 12 mm. length and shall be firmly riveted to the base plate case of iron pivot and in single piece base in the case of brass pivot.

**M-44 PAINTS :**

44.1 Oil Paints :

Oil paints shall be of the specified colour and shade, and as approved. The ready mixed paints shall only be used. However, if ready mixed paint or specified shade or tint is not available white ready mixed paint with



approved stainer will be allowed. In such a case, the contractor shall ensure that the shade of the paint so allowed shall be uniform.

All the paints shall meet with the following general requirements -

- i] Paint shall not show excessive setting in a freshly opened full can and shall easily be redispersed with paddle to a smooth homogeneous state. The paint shall show no curdling, livering, caking or colour separation and shall be free from lumps and skins.
- ii] The paint as received shall brush easily, possess good levelling properties and show no running or sagging tendencies.
- iii] The paint shall not skin within 48 hours in a three quarters filled closed container.
- iv] The paint shall dry to a smooth uniform finish free from roughness, grit unevenness and other imperfections. Ready mixed paint shall be used exactly as received from the manufacturers and generally according to their instructions and without any admixtures whatsoever.

#### 44.2 Enamel Paints :

The enamel paint shall satisfy in general requirements as mentioned in specification of oil paints. Enamel paints shall conform to I.S. 2933-1991.

#### M-45 FRENCH POLISH :

The french polish of required tint and shade shall be prepared with the below mentioned ingredients and other necessary materials :

- i] Denatured spirit of approved quality.
- ii] Shellac.
- iii] Chandras.
- iv] Pigment.

The french polish so prepared shall conform to I.S. 348-1991.

#### M-46 MARBLE CHIPS FOR MARBLE MOSAIC TERRAZZO :

46.1 The marble chips shall be of approved quality and shades. It shall be hard, sound, dense and homogeneous in texture with crystalline and coarse grains. It shall be uniform in colour and free from stains, cracks, decay and weathering.

46.2 The size of various colours of marble chips ranging from the smallest upto 20 mm. shall be used where the thickness of top wearing layers is 6 mm. in size. The marble chips of approved quality and colours only as per grading as decided by the Engineer-in-charge shall be used for marble mosaic tiles or works.

46.3 The marble chips shall be machine crushed. They shall be free from foreign matter, dust etc. Except as above the chips shall conform to I.S. 2114-1990.

#### M-47 FLOORING TILES :

A] Plain Cement Tiles -

47.1.1 The plain cement tiles shall be of general purpose type. These are the tiles in the manufacture of which no pigments are used. Cement used in the manufacture of tiles shall be as per Indian Standards.

47.1.2 The tiles shall be manufactured from a mixture of cement and natural aggregates by pressure process. During manufacture, the tiles shall be subjected to a pressure of not less than 140 Kg./Sq.cm. The proportion of cement to aggregate in the backing of the tiles shall be not leaner than 1:3 by weight. The wearing face, though the tiles are of plain cement, shall be provided with stone chips of 1 to 2 mm size. The proportion of cement to the marble chips aggregate in the wearing layer of the tiles shall be three parts of cement to one part of chips by weight. The minimum thickness of wearing layer shall be 3 mm. The colour and texture of wearing layer shall be uniform throughout its face and thickness. On removal from mould, the tiles shall be kept in moist condition continuously atleast for seven days and subsequently, if necessary, for such long period as would ensure their conformity to requirements of I.S. 1237-1990 requiring resistance to wear and water absorption.

47.1.3 The wearing face of the tiles shall be plain, free from projections, depressions and cracks and shall be reasonably parallel to the back face of the tile. All angles shall be right angle and all edges shall be sharp and true.

47.1.4 The tile sizes shall generally be square shape 24.85cm. x 24.85cm. or 25cm. x 25cm. The thickness of the tiles shall be 20 mm.

47.1.5 The tolerance of length and breadth shall be plus or minus 1 mm. The tolerance on thickness shall be plus 5 mm.

47.1.6 The tiles shall satisfy the tests as regards transverse strength, resistance to wear and water absorption as per I.S. 1237-1980.

47.2 B] Plain Coloured Tiles :

47.2.1 These tiles shall have the same specifications as for plain cement tiles as per (A) above except that they shall have a plain wearing surface wherein pigments are used. They shall conform to I.S. 1237-1990.

47.2.2 The pigment used for colouring cement shall not exceed 10% by weight of cement used in the mix. The pigments, synthetic or otherwise, used for colouring tiles shall have permanent colour and shall not contain materials detrimental to concrete.

47.2.3 The colour of the tiles shall be specified in the item or as directed.

47.3 C] Marble Mosaic Tiles :

47.3.1 These tiles have the same specifications as per plain cement tiles except the requirements as stated below ---



- 47.3.2 The marble mosaic tiles shall conform to I.S. 1237-1990. The wearing face of the tiles shall be mechanically ground and filled. The wearing face of tiles shall be free of projections, depressions and cracks and shall be reasonably parallel to the back face of the tiles. All angles shall be right angles and all edges shall be sharp and true.
- 47.3.3 Chips used in the tiles be from smallest upto 20 mm. size. The minimum thickness of wearing layer of tiles shall be 6 mm. For pattern of chips to be laid on the wearing face, a few samples with or without their full size photographs as directed shall be presented to the Engineer-in-charge for approval.
- 47.3.4 Any particular samples, if found suitable shall be approved by the Engineer-in-charge, of he may ask for particular sized chips to be more or less in the sample presented. The samples shall have to be made by the contractor till a suitable sample finally approved for use in the work. The contractor shall ensure that the tiles supplied for the work shall be in conformity with the approved sample only, in terms of its dimensions, thickness of backing layer and wearing surface, materials, ingredients, colour shade, chips, distribution etc. required.
- 47.3.5 The tiles shall be prepared from cement conforming to Indian Standards or coloured portland cement generally depending upon the colour of tiles to be used or as directed.
- 47.4 D] Chequered Tiles :
- 47.4.1 Chequered tiles shall be plain cement tiles or marble mosaic tiles. The former shall have the same specification as per (A) above and the latter as per marble mosaic tiles as per (C) except as mentioned below.
- 47.4.2 The tiles shall be of nominal size of 250mm. x 250mm. or as specified. The centre to centre distance of the chequer shall not less than 25mm. and not more than 50mm. The overall thickness of the tile shall be 22mm.
- 47.4.3 The grooves in the chequers shall be uniform and straight. The depth of the grooves shall not be less than 3mm. The chequered tiles shall be plain, coloured or mosaic as specified. The thickness of the upper layer measured from the top of the chequers shall not be less than 6mm. The tiles shall be given the first grinding with machine before delivery to site.
- 47.4.4 Tiles shall conform to relevant I.S. 1237-1990.
- 47.5 E] Chequered Tiles for Staircases :
- 47.5.1 The requirements of these tiles shall be the same as chequered tiles as per (D) above except in following respects :
- The length of a tile including nose shall be 330 mm.
  - The minimum thickness shall be 28 mm.
  - The nosing shall have also the same wearing layer at the top.
  - The nosing edge shall be rounded.
  - The front portion of the tile for a minimum length of 75mm. from and including the nosing shall have grooves running parallel to nosing and at centres not exceeding 25mm. Beyond that the tiles shall have normal chequer pattern.
- M-48 ROUGH KOTAH STONE :**
- 48.1 The kotah stones shall be hard, even, sound and regular in shape and generally uniform in colour. The colour of the stone shall generally be green. Brown coloured stones shall not be allowed for use. They shall be without any soft veins, cracks or flaws.
- 48.2 The size of the stones to be used for flooring shall be size 600mm. x 60mm. and/or size 600mm. x 450mm. as directed. However, smaller sizes will be allowed to be used to the extent of maintaining the required pattern. Thickness shall be as specified.
- 48.3 Tolerance of minus 30 mm. on account of chisel dressing of edges shall be permitted for length as well as breadth. Tolerance in thickness shall be plus 3mm.
- 48.4 The edges of stones shall be truly chiselled and table rubbed with coarse sand before paving. All angles and edges of the stone shall be true, square and free from chipping and the surface shall be true and plain.
- 48.5 When machine cut edges are specified, the exposed edges and the edges at joints shall be machine cut. The thickness of the exposed machine cut edges shall be uniform.
- M-49 POLISHED KOTAH STONES :**
- 49.1 Polish kotah stone shall have the same specifications as per rough kotah stone except as mentioned below.
- 49.2 The stone shall have machine polished smooth surface. When brought on site, the stones shall be single polished or double polished depending upon its use. The stones for paving shall generally be single polished. the stones to be used for dedo, skirting, platforms sink, veneering, sills, steps etc. where machine polishing after the stones are fixed in situ is not possible shall be double polished.
- M-50 DHOLPUR STONE SLAB :**
- 50.1 Dholpur stone slab shall be of best quality as approved by the Engineer-in-charge. The stone slab shall be without any veins, cracks, and flaws. The stone slab shall be even, sound and durable, regular in shape and uniform colour.
- 50.2 The size of the stone shall be as specified in the item or detailed drawing or as approved by the Engineer-in-charge. The thickness of the stone shall be as specified in the item of work with the permissible tolerance of plus of minus 2 mm. The provisions in respect of polishing as for polished kotah stone shall apply to polished Dholpur stone also. All angles and edges of the face of stone slab shall be fine chiselled or polished as specified in the

item of work and all the four edges shall be machine cut. All angles and edges of the stone slab shall be true and plane.

- 50.3 The sample of stone shall be got approved from the Engineer- in-charge for shade and tint for a particular work. It shall be ensured the stones to be used in a particular work shall not differ much in shade or tint from the approved sample.

**M-51 MARBLE SLAB :**

Marble slabs shall be white or of other colour and of best quality as approved by the Engineer-in-charge. Slab shall be bard, close, uniform and in texture. They shall also be free defects and cracks. The surface shall be machine polished to an even and perfectly plane surface and the edges, machine cut true and square. The rear face shall be rough enough to provide key for the mortar.

Marble slabs with natural veins, if selected shall have to be laid as per the pattern given by the Engineer-in-charge. Size of the slabs shall be minimum 450mm. x 450mm. and preferably 600mm. x 600mm. However, smaller sizes will be allowed to be used to the extent of maintaining required pattern.

The slab shall not be thinner than the specified thickness at its thinnest part. A few specimen of finished slab to be used shall be deposited by the contractor in the office for reference.

Except as above, the marble slabs shall conform to I.S. 1130-1993 or as revised from time to time.

**M-52 GRANITE STONE SLAB :**

- 52.1 Granite shall be of approved colour and quality, The stone shall be hard even, sound and regular in shape and generally uniform in colour. It shall be without and soft veins, cracks or flaws.

52.2 The thickness of the stone shall be specified in the item.

52.3 All exposed faces shall be double polished to tender truly smooth and even relecting surface. The exposed edges and corners shall be rounded off as directed. The exposed edges shall be machine cut and shall have uniform thickness.

**M-53 P.V.C. FLOORING :**

- 53.1 P.V.C. sheets for P.V.C. floor covering shall be homogenous flexible type, conformint to I.S. 3462-1991. The P.V.C. covering shall neither develop any toxic effect while put to use not shall give off any disagreeable odour.

53.2 Thickness of flexible type covering or tiles shall be as specified in the description of the item.

53.3 The flexible type shall be backed with hessain or other woven fabric. The following tolerance shall be applicable on the nominal dimensions of the sheet rolls or tiles :

- (a) Thickness +/- 0.15 mm
- (b) Length or width
  - 1. 300 mm Square tiles +/- 0.20 mm
  - 2. 600 mm Square tiles. +/- 0.40 mm
  - 3. 900 mm Square tiles. +/- 0.60 mm
  - 4. Sheets and rolls. +/- 0.10 percent.

53.4 Adhesive :

53.4.1 The adhesive for PVC flooring shall be of the type and make recomended by the manufacturers of PVC sheets tiles.

**M-54 FACING TILES :**

54.1 The facing tiles (burnt clay facing bricks) shall be free from cracks, flaws, and nodules of free lime. They shall be thoroughly burnt and shall have plane rectangular faces with parallel sides and sharp stright right angled faces. The texture of the finished surface that will be exposed when in place, shall conform to an approved sample consisting not less than four stretcher bricks each representing resistance to penetration by rain and greater durability than common bricks. The tiles shall conform to I.S. 2691-1995.

54.2 The standard size of facing brick tiles shall be 19 x 9 x 4 cms. The facing brick tiles shall be provided with frog which shall conform to I.S. 1077-1992.

54.3 The permissible tolerance in dimensions specified above shall be as follows.

Size	Torrence for	
	1st Class Brick	2nd Class Brice
19 cm	+/- 6 mm	+/- 10 mm
9 cm	+/- 2 mm	+/- 7 mm
4 cm	+/- 1.5 mm	+/- 3 mm

The tolerance for distortion or warpage of face or edges of individual brick from a plane surface and from a straight line respectively shall be as follows :

Facing dimensions. Permissible tolerance.

Max. below 19 cms. Max. 2.5 mm.

Max. above 19 cms. Max. 3.0 mm

54.5 The average compressive strength obtained as a sample of five tiles when tested in accordances with the produre aid as per I.S. 1077-1992 shall be not less than 175 Kg/Sq.cm. The average compressive strength of any individual brick shall not less than 160 Kg/Sq.cm.





- 54.6 The average water absorption for five brick tiles shall not be exceed 12 percent of average weight of brick before testing. The absorption for each individual brick shall not exceed 25 percent.
- 54.7 The brick tiles when tested in accordance with I.S. 1077-1992 the rate of efflorescence shall not be more than "Slightly effloresced".
- M-55 WHITE GLAZED TILES :**
- 55.1 The tiles shall be of best quality as approved by the Engineer-in-charge. They shall be flat and true to shape. They shall be free from cracks, crazing, spots, chipped edges and corners. The glazing shall be of uniform shade.
- 55.2 The tiles shall be of nominal size of 150mm. x 150mm. unless otherwise specified. The maximum variation from the stated sizes, other than the thickness of tile, shall be plus or minus 1.5mm. The thickness of the tile shall be 6mm. except as above the tiles shall conform to I.S. 777-1988.
- M-56 GALVANISED IRON PIPES AND FITTINGS :**
- Galvanised iron pipe shall be of the medium type and of required diameter and shall comply with I.S. 1239-1990. The specified diameter of the pipes shall refer to the inside diameter of the bore. Clamps, screw and all galvanised iron fittings shall be of the standard 'R' or equivalent make.
- M-57 BIB COCK AND STOP COCK :**
- 57.1 A bib cock is a draw off tap with a horizontal inlet and a free outlet. A stop cock is a valve with a suitable means of connection for insertion in a pipe line for controlling or stopping the flow.
- 57.2 They shall be of screw down type and or brass chromium plated and of diameter as specified in the description of the item. They shall conform to I.S. 781-1990 and they shall be of best Indian make. They shall be polished bright.
- 57.3 The minimum finished weight of bib cock and stop shall be as given below--
- | Dia.   | Bib Cock | Stop Cock | Dia.   | Bib Cock | Stop Cock |
|--------|----------|-----------|--------|----------|-----------|
| 8 mm.  | 0.25 Kg. | 0.25 Kg.  | 15 mm. | 0.40 Kg. | 0.40 Kg.  |
| 10 mm. | 0.30 Kg. | 0.35 Kg.  | 20 mm. | 0.75 Kg. | 0.75 Kg.  |
- M-58 GUN METAL WHEEL VALVE :**
- 58-1 The gun metal wheel valve shall be of approved quality. These shall be of gun metal fitted with wheel and shall be of gate valve opening full way and of the size as specified. These shall conform to I.S. 778-1990.
- M-59 WHITE GLAZED PORCELAIN WASH BASIN :**
- 59.1 Wash basin shall be of white porcelain first quality best Indian make and it shall conform to I.S. 2556-(Part-IV)-1994 and I.S. 771-1990. The size of the wash basin shall be as specified in the item. The wash basin shall be of one piece construction with continued over-flow arrangements. All internal angles shall be designed so as to facilitate cleaning. Wash basin shall have single tap hole or two holes as specified. Each basin shall have a circular waste hole which is either rebated or bevelled internally with 65 mm. dia. at top and 10 mm. depth to suit the waste fitting. The necessary stud slot to receive the bracket on the under side of the basin shall be provided. Basin shall have an internal soap holder recess which shall fully drain into the bowl.
- 59.2 White glazed pedestal of the quality and colour as that of the basin shall be provided where specified in the item. It shall be completely recessed at the back for reception of supply and water pipe. It shall be capable of supporting the basin rigidly and adequately and shall be so designed as to make the height from the floor to top of the rim of basin 750 mm. to 800 mm. as directed.
- M-60 EUROPEAN TYPE WATER CLOSET/WITH LOW LEVEL FLUSHING :**
- 60.1 The European type water closet shall be white glazed conforming to I.S. 2556-1994 and I.S. 771-1692.
- 60.2 'S' trap shall be provided as required with water seal not less than 50 mm.
- The solid plastic seat and cover shall be of the best Indian make conforming to I.S. 2548-1996. They shall be made of moulded synthetic materials which shall be tough and hard with high resistance to solvents and shall be free from blisters and other surface defects and shall have chromium plated brass hinges and rubber butter of suitable size.
- M-61 ORISSA TYPE WATER CLOSET :**
- 61.1 The specification of Orissa type white glazed water closet of first quality shall conform to I.S. 2556 (Part-III) 1994 and relevant specification of Indian type water closet except that pan will be with the integral squaring pan of size 580 mm x 440 mm. with raised footrest.
- M-62 INDIAN TYPE WATER CLOSET :**
- The Indian type white glazed water closet of first class quality, size as specified in the item and conforming to I.S. 771-1979 and I.S. 2556-(Part-II)-1994. Each pan shall have integral flushing ring of suitable type with adequate number of holes all around as directed to have satisfactory flushing. It shall also have an inlet at back of front for connecting flush pipe as directed. The inside of the bottom of the pan shall have sufficient slope from the front towards the outlet and the surface shall be uniform and smooth. Pan shall be provided with 100 mm. diameter 'P' or 'S' trap with approximately 50 mm. water seal and 50 mm. diameter vent horn.
- FOOT RESTS :**
- A pair of white glazed earthen ware rectangular foot rests of minimum size 250 mm. x 130 mm. x 20 mm. shall be provided with the water closet.
- M-63 GLAZED EARTHEN WARE SINK :**





The glazed earthenware sink shall be of specified size, colour and quality. The sink shall conform to I.S. 771- Part-II-1992. The brackets for sinks shall conform to I.S. 775-1990.

The pipes shall conform to I.S. 1239-Part-I-1990 and I.S. 404-1993 for steel and lead pipes respectively. 32 mm. brass waste coupling of standard pattern with brass chain and rubber plug shall be provided with sink.

**M-64 GLAZED EARTHEN WARE LIPPED TYPE FLAT BACK URINAL/CORNER TYPE URINAL:**

The lipped type urinal shall be flat back or corner type as specified in the item and shall conform to I.S. 771-1992. It shall be of best Indian make and size as specified and approved by the Engineer-in-charge. The flat back or corner type urinal must be of first class quality, free from any defects, cracks etc.

**M-65 LOW LEVEL ENAMEL FLUSHING TANK:**

65.1 The low level enamel flushing tank shall be of 15 litres capacity. It shall conform to I.S. 774-1990. The flushing cistern shall be of best quality and free from any defects. The flushing tank shall have outlet 32 mm diameter. The outlet shall be connected with W.C. Pan by lead pipe of P.V.C. pipe as specified. The flushing tank shall be provided with inlet and outlet for fixing G.I. inlet pipes and over flow pipes. The flushing cistern shall be provided with chromium plated handle for flushing. The flushing tank shall be provided with bracket of cast iron so that it can be fixed on wall at specified height. The brackets shall conform to I.S. 775-1990.

**M-66 CAST IRON FLUSHING CISTERN :**

66.1 The cast iron flushing cistern shall be of 15 litres capacity. It shall conform to I.S. 774-1990. The flushing cistern shall be of best quality free from any defects.

66.2 The flushing cistern shall have outlet of 32 mm diameter. The outlet shall be connected to lead pipe of 32 mm diameter. The lead pipe shall conform to I.S. 404 (Part-I) 1993. For fixing G.I. inlet pipes and overflow pipe 20 mm dia. inlet and outlet shall be provided. The flushing cistern shall be provided with galvanised iron chain and pull of sufficient length and shall be got approved from the Engineer-in-charge. The cast iron flushing cistern shall be painted with one coat of anticorrosive paint and two coats of paints. The flushing cistern shall be fixed on to C.I. brackets. The brackets shall conform to I.S. 775-1990.

**M-67 FLUSH COCK :**

Half turn flush cock (heavy weight) shall be of gun metal chromium plated of diameter as specified in the description of the item. The flush cock shall conform to relevant Indian Standards.

**M-68 CAST IRON PIPES AND FITTINGS :**

68.1 All soil, waste, vent and antisiphonage pipes and fittings shall conform to I.S. 1729-1991. The pipes shall have spigot and socket ends with head on spigot end. The pipes and fittings shall be true to shape, smooth, cylindrical their inner and outer surfaces being as nearly as practicable concentric. They shall be sound and nicely cast and shall be free from cracks, laps, pin holes or other imperfections and shall be neatly dressed and carefully fettled.

68.2 The end of pipes and fittings shall be reasonably square to their axis.

68.3 The sand cast iron pipes shall be of the diameter as specified in the description and shall be in length of 1.5 M., 1.8 M. & 2.0 M. including socket ends of the pipe unless shorter length are either specified or required at junction etc. The pipes and fittings shall be supplied without ears unless specified or directed otherwise.

68.4 Tolerances : The standard weights and thickness of pipes shall be as shown in the table below. A tolerance upto minus 10% may however be allowed against these standard weights.

Sr. No.	Nominal dia of bore	Overall Thick	Wight of pipe excluding ears		
			1.5 m long	1.m long	2 m long
1.	75 mm	5.00 mm	12.83 Kg.	16.52 Kg.	18.36 Kg.
2.	100 mm	5.0 mm	18.14 Kg.	21.67 Kg.	24.15 Kg.
3.	150 mm				
4.	250 mm				

A tolerance upto minus 15% in thickness and 20 mm. in length will be allowed. For fittings tolerance in lengths shall be plus 25 mm. and minus 10 mm.

The thickness of fittings and their socket and spigot dimensions shall conform to the thickness and dimensions specified for the corresponding sizes of straight pipes. The tolerance in weights and thickness shall be the same as for straight pipes.

**M-68-A P.V.C. Pipes & Fittings:-**

1. All soil, waste and vent pipes & fittings shall conform to I.S. 4985-1988 & I.S. 13592:1992. The pipes are provided with an integral rubber ring type socket at one end while the other end in kept plain, smooth & free from burrs. The pipes and fittings shall be true to shape, smooth & cylindrical. They shall be free from cracks, laps, pinholes or other imperfection and shall be nearly dressed and carefully fettled.

2. The P.V.C. Pipes shall be of the diameter as specified in the description and shall be in length of 6.0, 3.0 & 1.8 m including socket ends of the pipe unless shorter length are either specified or required at junction etc. Tolerances on specified length shall be + 10 mm and- 0 mm.



3. Rubber real rings for joints and Access Doors shall be manufactured in accordance with IS: 5382-1998. There are made out of natural rubber with a shore 'A' hardness of 40+5.
- 4.1 The mean outside diameter, outside diameter at any point and wall thickness manufactured plain or with socket shall be as shown in the following table:-

\* All dimensions in millimeters.

Sr. No.	Nomian/Outside dia	Mean outside Diamter		Outside diameter at		Wall whtick	
		Min.	Max.	Min.	Max.	Min.	Max
1.	75	70.0	75.3	74.1	75.9	3.2	3.8
2.	100.	110.00	100.4	108.6	111.4	3.2	3.8

- 4.2 Minimum Wall thickness of sockets on pipes & Dimensions of sliding socket of pipes shall be as shown in following table.

\* All dimensions in millimeters.

Sr. No.	Nominal outside diameter	Minimum wall thick of sockets on pipes.		Socet Depth min.	Mean inaide diamete of societ at mil point	
		S2, Min	S3, Min		Min	Max
1.	75	2.9	2.4	40.00	75.1	75.3
2.	110	2.9	2.4	48.0	110.1	110.4

\* The outside diameter of pipe shall be obtained by the method given in IS: 12235(Part-1)-1998, wall thickness shall be measured by the method given in IS:12235(Part-2)1998.

- 4.3 The permissible variation between the mean outside diameter & the nominal outside diameter of a pipe shall be positive in the form + x, where is less than or equal to greater of the following two values.

a) 0.03 mm, and

b) 0.003 x nominal outside diameter- rounded off to the next higher 0.1 mm.

- 4.4 The permissible variation between the outside diameter at any point (d1) & the nominal outside diameter (de)of a pipe shall not exceed the greater of the following two values.

a) 0.5mm, and

b) 0.012 de rounde off to the next higher 0.1

- 4.5 The thickness of fittings and their socket & spigot dimensions shall conform to the thickness and dimensions specified for the corresponding sizes of straight pipes.

**M-69 NAHNI TRAP :**

Nahni trap shall be of cast iron and shall be sound and free from porosity or other defects which affect servicability. The thickness of the base metal shall not be less than 6.5 mm. The surface shall be smooth and free form crack, chips and other flaws or any other kind of defects which affect serviceability. The size of nahni trap shall be as specified and shall be of self cleansing design.

The nahni trap shall be of quality approved by the Engineer- in-charge and shall generally conform to the relevant Indian Standards.

The nahni trap provided shall be with deep seal, minimum 50 mm. except at places where trap with deep seal can not be accommdated. The cover shall be cast iron. Perforated cover shall be provided on the trap of appropriate size.

**M-70 GULLY TRAP :**

Gully trap shall conform to I.S. 651-1992. It shall be sound, free from defects such as fire cracks or hair cracks. The glaze of the traps shall be free from crazing. They shall give a sharp clear note when struck with light hammer. There shall be no broken blisters.

The size of the gully trap shall be as specified in the item.

Each gully trap shall have one C.I. grating of square size corresponding to the dimensions, of inlet of gully trap. It will also have a water tight C.I. cover with frame inside dimensions 300mm. x 300mm. the cover weighing not less than 4,53 Kg. and the frame not less than 2.72 Kg. The grating cover and frame shall be of sound and good casting and shall have truly square machined seating faces.

**M-71 GLAZED STONE WARE PIPE AND FITTINGS :**

The pipes and fittings shall be of best quality as approved by the Engineer-in-charge. The pipe shall be of best quality manufactured from stone-ware of fire clay, salt glazed thoroughly burnt throught the whole thickness, of a close even texture, free from air blows, fire blisters, cracks and other imperfections, which affect the serviceability. The inner and outer surfaces shall be smooth and perfectly glazed. The pipe shall be capable to withstand pressure of 1.5 m. lead without showing signs of leakage. The thickness of the wall shall not be less than (1/12)th of the internal dia. The depth of socket shall not be less than 38 mm. The socket shall be sufficiently large to allow a joint of 6 mm. around the pipe. The pipes shall generally conform to revelant I.S. 651-1992.

**M-72 WALL PEG SAIL :**



- 72.1 The aluminium wall peg rail shall have three aluminium pegs of approved quality and size. It shall be fixed on teakwood plank of size 450 mm x 75 mm x 20 mm. The teak wood shall be french polished or oil painted as specified.
- M-73 G.I. WATER SPOUT :**
- 73.1 The G.I. pipes of 40 mm dia shall be of medium quality and specials shall be of 'R' brand or equivalent brand of best quality.
- 73.2 The pipe shall have length as required for the thickness of well in which it is fixed, and at the outside end tee and bend cut at half the length shall be provided and at either end coupling shall be provided and the have better fixing. The water spout shall be provided as per detailed drawings or as directed.
- M-74 ASBESTOS CEMENT PIPE (A.C. PIPE) :**
- 74.1 The asbestos cement pipe of diameter as specified in the description of the item shall conform to I.S. 1926-1980. Special like bends, shoes cowls, etc. shall conform to relevant Indian Standards. The interior of pipe shall have a smooth finish, regular, surface and regular internal diameter. The tolerance in all dimensions shall be as per I.S. 1926-Part-I-1980.
- M-75 CRYDON BALL VALVE :**
- Ball valve of screwed type including polythene float and necessary lever etc. shall be of the size as mentioned in the description of item and shall conform to I.S. 1703-1989.
- M-76 BITUMEN FELT FOR WATER PROOFING AND DAMP PROOFING :**
- 76.1 Bitumen felt shall be on the fibre bases and shall be of type 2, self finished felt grade-2 and shall confor to I.S. 1322-1998.
- M-77 SELECTED EARTH :**
- 77.1 The selected earth shall be that obtained from excavated material or shall have to be brought from outside as indicated in the item. If item does not indicate anything, the selected earth shall have to be brought from outside.
- 77.2 The selected earth shall be good yellow soil and shall be got approved from the Engineer-in-charge. In no case black cotton soil or similar expansive and shrinkable soil shall be used. It shall be clean and free from all rubbish and perishable materials, stones or brick bats. The clods shall be broken to a size of 50 mm. or less. Contractor shall make his own arrangements at his own costs for land for borrowing selected earth. The stacking of materials shall be done as directed by the Engineer-in-charge in such a way as not to interfere with any constructional activities and in proper stacks.
- 77.3 When excavated material is to be used, only selected stuff got approved from the Engineer-in-charge shall be used. It shall be stacked separately and shall comply with all the requirements of selected earth mentioned above.
- M-78 CRACKSEAL :**
- Crackseal manufactured by Chemistic/Chemisol Indian Ltd., is an acrylic base ready application compound.
- M-79 CAST IRON STEPS :**
- The cast iron steps shall be clean, well-cast and they shall be free from air and sand holes, cold shuts and warping which are likely to impair the utility of the castings. The portion of the step which projects from walls of the manhole shall have a raised required designed above the general plane of the top surface of the step along the edges of the tread to provide adequate non-slip grip. The steps shall be of dimensions 375 mm x 150 mm x 25 mm with necessary holding arrangement and carting minimum weight of 4.5 Kg. confirming to I.S. 5455-1992 or its latest varison.
- The cast iron steps shall be coated with a material having tar base or a place bituminous composition of cashew-nut shall liquid. The coating shall be smooth and tenacious. It shall not flow when exposed to a temprature of 63 degree C and shall not be brittle as to chip of at temperature of 0 degree C.

Executive Engineer,  
SOUTH ZONE (UDHNA)  
Surat Municipal Corporation,  
SURAT.

SIGNATURE OF THE CONTRACTOR.

**GENERAL TECHNICAL SPECIFICATION FOR BUILDING WORKS****GENERAL :**

1. In the specification "as directed"/"Approved" shall be taken to mean "as directed"/approved by the Engineer-in-charge.
2. Wherever a reference to any Indian Standard appears in the specifications, it shall be taken to mean as a reference to the latest edition of the same in force on the date of agreement.
3. In "Mode of Measurement" in the specification wherever a dispute arises in the absence of specific mention of a particular point or aspect, the provisions on these particular point or aspects in the relevant Indian Standards shall be referred to.
4. All measurements & computations, unless otherwise specified, shall be carried out nearest to the following limits:  
( i ) Length, width and depth (height) ..... 0.01 Mt.  
( ii ) Areas ..... 0.01 Sq.Mt.  
(iii) Cubic Contents ..... 0.01 Cu.Mt.  
In recording dimensions of work.  
The sequence of length, width and height (depth) or thickness shall be followed.
5. The distance which constitutes lead shall be determined along the shortest partical route and not necessarily the route actually taken. The decision of the Engineer-in-charge in this regard shall be taken as final.
6. Where no lead is specified, it shall mean "all leads".
7. Lift shall be measured from plinth level.
8. Definite particulars covered in the items of work, though not mentioned or elucidated in its specifications shall be deemed to be included therein.
9. Reference to specifications of materials as made in the detailed specification the items of works is in the form of a designation containing the number of the specification of the material and prefix `M' e.g. `M-s'.
10. Approval of the samples of various materials given by the Engineer-in-charge shall not absolve the contractor from the responsibility of replacing defective material brought on site or materials used in the work found defective at a later date. The contractor shall have no claim to any payment or compensation whatsoever on account of any such materials being rejected by the Engineer-in-charge.
11. The contract rate of the item of work shall be for the work completed in all respects .
12. No collection of materials shall be made before it is got approved from the Engineer-in-charge.
13. Collection of approved materials shall be done at site of work in a systematic manner. Materials shall be stored in such a manner as to prevent damage, deterioration or intrusion of foreign matter and to ensure the preservation of their quality and fitness for the work.
14. Materials, if and when rejected by the Engineer-in-charge, shall be immediately removed from the site of work.
15. No materials shall be stored prior to, during and after execution of a structure in such a way as to cause or lead to damage on overloading of the various components of the structure.
16. All work shall be carried out in a workmanlike manner as per the best techniques for the particular item.
17. All tools, templates, machinery and equipment for correct execution of the work as well as for checking lines, levels, alignment of the works during execution shall be kept in sufficient numbers and in good working condition on the site of the work.
18. The mode procedure and manner of, execution shall be such that it does not cause damage or over-loding of the various components of the structure during execution of after completion of the structure.
19. Special modes of construction not adopted in general Engineering practice, if CONSTRUCTION OF to be adopted by the Contractor, shall be considered only if the contractor provides swatisfactory evidence that such special mode of construction is safe, sound and helps in speedy construction and completion of work to the required strength and quality. Acceptance of the same by the Engineer-in-charge shall not, however, absolve the contractor of the responsibility of any adverse effects and consequences of adopting the same in the course of execution of completion of the work.
20. All installations pertaining to water supply and fixtures thereof as well as drainage lines and sanitary fittings shall be deemed to be completed only after giving satisfactory tests by the Contractor.
21. The contractor shall be responsible for observing the rules and regulations imposed under the "Minor Minerals Act", and such other laws and rules prescribed by Government from time to time.
22. All necessary safety measures & precautions (including those laid down in the various relevent Indian Standards) shall be taken to ensure the safety of men, materials and machinery on the works as also of the work itself.
23. The testing charges of all materials shall be borne by the Contractor.
24. Approval to any or the executed items for the work dose not in any way releive the contractor of his responsibility for the correctness, soundness and strength of the structure as per the drawings and specifications.

Executive Engineer,  
SOUTH ZONE (UDHNA)  
Surat Municipal Corporation ,

SIGNATURE OF THE CONTRACTOR.

**ITEMWISE DETAILED TECHNICAL SPECIFICATIONS****Item No.1 (A) :-**

Excavation for foundation including sorting out and stacking off useful materials and disposing of the excavated stuff up to 50 mt. lead and all lift, watering etc.comp.

**1.1.0 GENERAL**

1.1.1 Any soil which generally yields to the application of pickaxes and shovels or jumpers or scarifiers phawaras rakes or any such excavation implement or organic soil, gravel, silt, sand turf loam, clay, peat etc. fall under this category.

**1.2.0 CLEARING THE SITE**

1.2.1 The site on which the structure is to be built shall be cleared, and all obstructions, loose stone, materials and rubbish of all kind, bush, wood and trees shall be removed as directed. The materials so obtained shall be the property of the Corporation and shall be conveyed and stacked as directed within 50 Mts. lead. The roots of the trees coming in the sides shall be cut and coated with a hot asphalt.

1.2.2 The rate of site clearance is deemed to be included in the rate of earth work for which no extra amount will be paid.

**1.3.0 SETTING OUT**

After clearing the site, the centre lines will be given by the Engineer-in-charge. The contractor shall assume full responsibility for alignment, elevation and dimension of each and every part of the work. The contractor shall supply labour, materials etc. required for setting out the reference marks and bench marks and shall maintain them as long as required and directed.

**1.4.0 EXCAVATION**

The excavation in foundation shall be carried out in true line and level and shall have the width and depth as shown in the drawings or as directed. The contractor shall do the necessary shoring and shuttering at his own cost and as approved by the Engineer or his Consultant. The payment for such precautionary measures shall be included in this work. The bottom of the excavated area shall be levelled both longitudinally & transversely as directed by removing and watering as required. No earth filling will be allowed for bringing it to level, if by mistake or any other reason excavation is made deeper or wider than that shown on the plan or as directed. The extra depth or width shall be made up with concrete of the same proportion as specified for the foundation concrete at the cost of the contractor. The excavation upto 1.5 Mts. depth shall be measured under this item. The site conditions may require excavation in parts as per schedule of excavation. No extra payment will be claimed for this operation schedule.

**1.5.0 DISPOSAL OF EXCAVATED MATERIALS**

1.5.1 No materials excavated from the foundation trenches, of whatever kind they may be, are to be placed even temporarily upto 1.5 Mts. or at the distance prescribed by the Engineer, from the outer edge of excavation. All materials excavated shall remain the property of the Corporation. Rate of excavation shall include sorting out of useful materials and stacking them separately as directed within the specified lead. Materials suitable and useful for backfilling or other use shall be stacked in convenient places but not in such a way as to obstruct free movement of men, animals and vehicles or encroach upon the area required for constructional purposes. The site shall be left clean of all debris on completion.

1.5.2 Disposal of excavated materials is subject to the following - Unsuitable materials obtained from clearing site and excavation shall be disposed off within a lead of 50 Mts. as directed. Useful materials obtained from clearing site & excavation shall be stacked within lead of 50 Mts. beyond the building area as directed. Materials suitable for back-filling shall be stacked at convenient places within a lead of 50 Mts. and will be allowed to be used by the contractor on payment at rates laid down in the contract or if not so laid down, at scheduled rates of the Division or at mutually agreed rates if there are no such rates in the schedule of rates.

**1.6.0 MODE OF MEASUREMENT AND PAYMENT**

1.6.1 The measurement of excavation in trenches for foundation shall be made according to the sections of trenches shown on the drawing or as per sections given by the Engineer-in-charge or as directed. No payment shall be made for surplus excavation made in excess or above requirements or due to stopping and sloping back as found necessary on account of conditions of soil and requirements of safety or construction schedule requiring excavation to be done in parts.

1.6.2 No extra payment shall be made for temporary pumping of water / sewage due to abnormal adverse conditions / climate.

1.6.3 The rate shall be for a unit of one cubic meter.

**Item No.1 (B) :-**

Excavation for foundation including sorting out and stacking of useful material and disposing of the excavated stuff upto 50 mt. lead includes shoring, strutting etc. if required and bailing out of water (dewatering) if necessity arises with contractor's equipment etc. complete.

**1.1.0 WORKMANSHIP**

1.1.1 The relevant specification of item No.1(A) shall be followed except that the excavation work shall be carried out in all sorts of soil with lift 1.5 Mts. to 2.0 Mts. & 2.0 to 2.5 mt depth.

**1.2.0 MODE OF PAYMENT**





- 1.2.1 The relevant specifications of item No.1(A) shall be followed.  
1.2.2 The excavation work of lift 1.5 Mts. to 2.0 Mts. and 3.0 to 3.0 mt depth shall be measured under this item.  
1.2.3 The rate shall be for a unit of one cubic metre.

**ITEM NO.2 :-**

Providing and laying cement concrete 1:3:6(1cement : 3 sand : 6 graded stone aggregates 40mm nominal size) and curing complete excluding cost of formwork in

**2.1.0 Materials:-**

Water shall conform to M-1. Cement shall conform to M-3.Sand shall conform to M-6.Stone aggregate 40 mm nominal size shall conform to M-12.

**2.2.0 WORKMANSHIP :****2.2.1 General :-**

Before starting concreting the bed of foundation trenches shall be cleared of all loose materials, levelled, Waterred and rammed as directed.

**2.2.2 Proportion of Mix :-**

The proportion of cement, sand coarse aggregate shall be one part of cement, 3 parts of sand 6 parts of stone aggregate shall be measured by volume.

**2.2.3 Mixing :-**

The concrete shall be mixed in a mechanical mixer at the site of work. Hand mixing may however be allowed for smaller quantity of work if approved by Engineer-in-charge. When hand mixing is permitted by the Engineer-in-charge in case of break down of machineries and in the interest of the work, it shall be carried out on a water tight platform and care shall be taken to ensure that mixing is continued until the mass is uniform in colour and consistency. However in such case 10% more cement than otherwise required shall have to be used without any extra cost. The mixing in mechanical mixer shall be done for a period 1 1/2 to 2 minutes. The quantity of water shall be just sufficient to produce dense concrete of required workability for the purpose.

**2.2.4 Transporting and placing the concrete :-**

The concrete shall be handed from the place of mixing to the final position in not more than 15 minutes by the method as directed and shall be placed into its final position, compacted and finished within 30 minutes of mixing with water i.e. before the setting commences.

The concrete shall be laid in layers of 15 cms to 20 cms.

Compacting :-The concrete shall be rammed with heavy iron rammer and rapidly to get the required compaction and to allow the interstices to be filled with mortar.

**2.2.5 Curing :-**

After the final set,the concrete shall be kept continuously wet, if required by ponding for a period of not less than 7 days from the date of placement.

**2.3.0 Mode of measurements and payment :-**

The concrete shall be measured for its length breadth and depth, limiting dimensions to those specified on plan or as directed. The rate shall be for a unit of one cubic meter.

**ITEM NO.2A :-**

Prov. & laying cement concrete 1:2:4 (1 cement : 2 sand : 4 graded stone agg 20 mm nominal size ) & curing comp. Include. Cost of form work but exclu. Cost of reinforcement for reinforced concrete work in Mass Concrete for Wall caps / copings

Details specification as per item no.2 but read 1:2:4 instead of 1:3:6 and as directed by Engineer-in-charge.

The rate shall be for a unit of one cubic metre.

**ITEM NO.3 :-**

Providing and laying cement concrete work 1:1.5:3 [1 cement :1.5 coarse sand: 3 graded stone aggregates 20 mm nominal size] and curing complete including cost of form work and excluding cost of reinforcement for reinforced concrete work in [a] foundation footing, Base of columns and mass concrete [b] independent piers, columns and pillars [c] staircase [d] vertical and horizontal fins.

**3.1.0 Materials :-**

Water shall conform to M-1, Cement shall conform to M-3. Sand shall conform to M-6. Grit shall conform to M-8. Graded stone aggregate 20 mm nominal size shall conform to M-12.

**3.2.0 General :-**

3.2.1 The concrete mix is not required to designed by preliminary tests. The proportion of the concrete mix shall be 1:1.5:3 [1 cement: 1.5 coarse sand: 3 graded stone aggregate 20 mm nominal size] by volume Concrete work shall have exposed concrete surface or as specified the item.

3.2.2 The designation ordinary M-100, M-150, M-200, M-250 specified as per I.S.corresponding approximately to 1:3:6 1:2:4, 1:1:1, 1/2: 3 and 1:1:2 nominal mix of ordinary concrete by volume respectively with conforming to IS:456.





3.2.3 The ingredients required for ordinary work, containing one bag of cement of 50 kg. by weight [0.0342 cu.m.] for different proportion of mix shall be as under.

Grade	Toral quantity of dr aggregate by volume per 50 Kg. of cement t be taken as the sume of individual volume of fine and coarse aggregate maximum	Proportion of fine aggregate of coarse aggregate	quantity of water per 50 Kg. of cement maximum
M-100 (1:3:6)	300 Liters	Generally 1:3 for fine aggregate to coarse aggregate by volume but subject to and upper limit	35 Liters
M-150 (1:2:4)	220 Liters		32 Liters
M-200 (1:1.5:3)	160 Liters		30 Liters
M-250 (1:1:2)	100 Liters		27 Liters

3.2.4 The water cement ratios shall not be more then those specified in the table. The cement content of the mix specified in the table shall be increased if the quantity of water in a mix has to be increased to overcome the difficulties of placement and compaction so that the water cement ratio specified in the table is not exceeded.

3.2.5 Workability of the concrete shall be controlled by maintaining a water cement ratio that is found to give a concrete mix which is just sufficiently wet to be placed and compacted without difficulty with the means available.

3.2.6 The maximum size of coarse aggregate shall be as large as possible within the limits specified but in no case greater than one fourth of the minimum thickness of the member, provided that the concrete can be placed without difficulty so as to surround all reinforcement throughly and to fill the corners of the form.

3.2.7 For reinforced concrete work, coarse aggregates having a nominal size of 20 mm generally considered satisfactory.

3.2.8 For heavily reinforced concrete members as in the case of the ribs of main beams the nominal maximum size of coarse aggregate should usually be restricted to 5 mm, less than the minimum clear distance between the main bars, or 5 mm, less than the minimum cover to the reinforcement whichever is smaller.

3.2.9 Where the reinforcement is widely spaced as in solid slabs, limitations of size of the aggregate may not be so important and the nominal maximum size may some times be as great as or grearar than the minimum cover.

3.2.10 Admixture may be used in concrete only with approval of Engineer-in-charge based upon the evidance that with the passage of time; neither the compressive strength of concrete is reduced nor are other requisite qualities of concrete and steel impaired by the use of such admixtures.

3.3.0 **WORKMANSHIP :**

3.3.1 General :- The bars shall be kept in position by the following method:

In case of beam and slab construction, sufficient number of precast cover blocks in cement mortar 1:2 [ 1 cement 2 coarse sand ] about 4 x 4 cms. section of thickness equal to the specified cover shall be placed between the bars and shuttering as to secureand maintain the requisite cover of concrete over the reinforcement.

In case or cantilevered or doubly reinforced beams or slabs, the main reinforcing bars shall be held in position by introducing cabin spacers or supports bars at 1.0 to 1.2 metres centres.

In case of columns and wall, the vertical bars shall be kept in position by means of timber timpltes with slotes accurately cut in them, the templtles shall be removed after concreting has been done below it. The bars may also be suitably tied by means of annealed steel wires to the shuttering to maintain their position during concreting.

All bars projecting from pillars, columns,beams, slabs etc. to which other bars and concrete are to be attached or bounded to lateron, shall be protected with a coat of thin neat cement grout, if the bars are not likely to be incorporated with succeeding mass of concrete within the following 10 days. This coat of thin neat cement shall be removed before concreting.

3.3.2 Proportioning :-

Proportioning shall be done by volume, except cement which shall be measured in terms of bags of 50 kg. weight. The volume of one such bag being taken as 0.0342 cu. metre Boxes of suitable sizes shall be used for measuring sand and aggregate. The size of the boxes [ internal ] shall be 35x25 cms.and 40 cms.deep.While measuring the aggregate and sand,the boxes shall be filled without shaking, ramming or hammering. The proportioning of sand shall be on the basis if its dry volume and in case if damp sand, allowances for bulkage shall be made.



- 3.3.3 Mixing :-
- 3.3.3.1 For all work, concrete shall be mixed in a mechanical mixer which alongwith other accessories shall be kept in first class working condition and so maintained throughout the construction. Measured quantity of aggregate, sand and cement required for each batch shall be poured into the drum of the mechanical mixer while it is continuously running. After about half a minute of dry mixing measured quantity of water required for each batch of concrete mix shall be added gradually and mixing continued for another one and half minute. Mixing shall be continued till materials are uniformly distributed and uniform colour of the entire mass is obtained and each individual particle of the coarse aggregate shown complete coating of mortar containing its proportionate amount of cement. In no case shall the mixing be done for less than two minutes after all ingredients have been put into the mixer.
- 3.3.3.2 When hand mixing is permitted by the Engineer-in-charge for small jobs or for certain other reasons, it shall be done on the smooth watertight platform large enough to allow efficient turning over the ingredients of concrete before and after adding water. Mixing platform shall be so arranged that no foreign material gets mixed with concrete nor the mixing water flow out. Cement in required number of bags shall be placed in a uniform layer on top of the measured quantity of fine and coarse aggregate, which shall also be spread in a layer of uniform thickness on the mixing platform. Dry coarse and fine aggregate and cement shall then be mixed thoroughly by turning over to get a mixture of uniform colour. Specified quantity of water shall then be added gradually through a rose can and the mass turned over till a mix of required consistency is obtained. In hand mixing, quantity of cement shall be increased by 10 percent above that specified.
- 3.3.3.3 Mixer which have been out of use for more than 30 minutes shall be thoroughly cleaned before putting in a new batch, unless otherwise agreed to by the Engineer-in-charge. The first batch of concrete from the mixture shall contain only two thirds of normal quantity of coarse aggregate. Mixing plant shall be thoroughly cleaned before changing from one type of cement concrete to another.
- 3.3.4 Consistency :
- The degree of consistency which shall depend upon the nature of the work and methods of vibration of concrete, shall be determined by regular slump test in accordance with I.S. 1199 : 1959. The slump of 10 mm to 25 mm shall be adopted when vibrators are used and 80 mm when vibrators are not used.
- 3.3.5 Inspection :
- 3.3.5.1 Contractor shall give the Engineer-in-charge due notice before placing any concrete in the forms to permit to inspect and accept the false work and forms as to their strength, alignment and general fitness but such inspection shall not relieve the contractor of his responsibility for the safety of men, machinery, materials and for results obtained. Immediately before concreting, all forms shall be thoroughly cleaned.
- 3.3.5.2 Centring design and its erection shall be got approved from the Engineer-in-charge. One carpenter with helper shall invariably kept present throughout the period of concreting. Movement of labour and other persons shall be totally prohibited for reinforcement laid in position. For access to different parts suitable mobile platform shall be provided so that steel reinforcement in position is not disturbed. For ensuring proper cover, mortar blocks of suitable size shall be cast and tied to the reinforcement. Timber, kapachi or metal pieces shall not be used for this purpose.
- 3.3.6 Transporting and laying :-
- 3.3.6.1 The method of transporting and placing concrete shall as approved. Concrete shall be so transported and placed that no contamination segregation or loss of its constituent material takes place.
- 3.3.6.2 All form work shall be cleaned and made free from standing water dust snow or ice immediately before placing of concrete. No concrete shall be placed in any part of structure until the approval of Engineer-in-charge.
- 3.3.6.3 Concreting shall proceed continuously over the area between construction joints. Fresh concrete shall not be placed against concrete which has been in position for more than 30 minutes unless a proper construction joint is formed. Concrete shall be compacted in its final position within 30 minutes of its discharge from the mixer. Except where otherwise agreed to by the Engineer-in-charge concrete shall be deposited in horizontal layers to a compacted depth of not more than 0.45 metre when internal vibrators are used and not exceeding 0.30 metre in all other cases.
- 3.3.6.4 Unless otherwise agreed to by the Engineer-in-charge, concrete shall not be dropped into place from a height exceeding 2 meters.
- 3.3.6.5 When trunking or chutes are used they shall be kept close and used in such a way as to avoid segregation. When concreting has to be resumed on a surface which has hardened, it shall be roughened, swept clean, thoroughly wetted, and covered with a 13 mm thick layer of mortar composed of cement and sand in the same ratio as in the concrete mix itself, this 13 mm layers of mortar shall be freshly mixed and placed immediately before placing of new concrete. Where concrete has not fully hardened, all laitance shall be removed by scrubbing the wet surface with wire or bristle brushes, care being taken to avoid dislodgement of any particles, of coarse aggregate. The surface shall then be thoroughly wetted, all free water removed, and then coated with neat cement grout, The first layers of concrete to be placed on this surface shall not exceed 150 mm in thickness and shall be well rammed against old work, particular attention being given to corners and close spot.



- 3.3.6.6 All concrete shall be compacted to produce a dense homogeneous mass with the assistance of vibrators, unless otherwise permitted by the Engineer - in - charge for exceptional cases such as concreting under water where vibrators cannot be used. Sufficient vibrators in serviceable condition shall be kept at site so that spare equipment is always available in the event of breakdowns.
- 3.3.6.7 Concrete shall be judged to be compacted when the mortar fills the spaces between the coarse aggregate and begins to cream upto form an even surface. Compaction shall be completed before the initial setting starts i.e. within 30minutes of addition of water to dry mixture. During compaction. It shall be observed that needle vibrators are not applied on reinforcement which is likely to destory the bond between concrete and reinforcement.
- 3.3.7 Curing :-  
Immediately after compaction, concrete, weather including rain, running water, shocks, vibration, traffic, rapid temperature changes frost and drying out process it shall be covered with wet sacking, hossion or other similar absorbant material approved, soon after the initial set and shall be kept continuously wet for a period of not less than 14 days from the date of placement. Masonary work over foundation concrete may be started after 48 hours of its laying but curing of concrete shall be continued for a minimum period of 14 days.
- 3.3.8 Sampling and Testing of concrete :-
- 3.3.8.1 Samples from fresh concrete shall be taken as per IS 1199:1999 and cubes shall be made, cured and tested at 7 days and 28 days as per requirements in accordance with IS 516:1959. A random sampling procedure shall be adopted to ensure that each concrete batch shall have a resonable chance of being tested i.e. the sampling should be spread over the entire period of concreting and cover all mixing units. The minimum frequency of sampling of concrete of each grade shall be in accordance with following.
- 3.3.8.2
- | Quantity of concrete in the work | No. of samples  |
|----------------------------------|---|
| 1-5 Cmt.                         | 1   |
| 6-15 Cmt.                        | 2   |
| 16-30 Cmt.                       | 3   |
| 31-50 Cmt.                       | 4   |
| 51-and above                     | 4+one additional sample for each additional 50 cmt. or part there of. |
- Note:- Atleast one sample shall be taken from shift. The test specimens shall be made from each sample, five for testing at 7 days and the remaining five at 28 days. The samples of concrete shall be taken on each day of the concreting as per above frequency. The number of specimens may be suitably increased as deemed necessary by the Engineer-in-charge when procedure of tests given above reveals a poor quality of concrete and in other special cases.
- 3.3.8.3 The average strength of the group of cubes cast for each day shall not be less than the specified cube strength of 150 kg/cm<sup>2</sup> at 28 days. 20% of the cubes cast for each day may have value less than the specified strength provided the lowest value is not less than 85% of the specified strength. If the concrete made in accordance with the proportion given for a particular grade does not yield the specified strength such concrete shall be classified as belonging the the appro-priate lower grade. Concrete made in accordance with the proportions given for a particular grade shall not, however, be placed in a higher grade on the ground that the test strength are higher than the minimum specified.
- 3.3.9 Stripping :
- 3.3.9.1 The Engineer- in- charge shall be informed in advance by the contractor of his intention to struck the form work. While fixing the time for removal of form work, due consideration shall be given to local conditions, character of the structure,the weather & other conditions that influence the setting of concrete and of the materials used in the mix. In normal circumstances [ generally where temperatures are above 20°C] and where ordinary concrete is used forms may by struck after expiry of period specified in the Item No.4 for respective item of form work.
- 3.3.9.2 All form work shall be removed without causing any shock or vibration as would damage the concrete. Before the soffit are removed,the concrete surface shall be exposed, where necessary in order to ascertain that the concrete has sufficiently hardened.Centring shall be gradually and uniformly lowered in such a manner as to permit the concrete to take stresses due to its own weight uniformly and gradually. Where internal metal ties are permitted they or their removeable parts shall be extracted without causing any damage to the concrete and remaining holes filled with mortar. No permanently embeded metal part shall have less than 25 mm.Cover to the finished concrete surface. Where it is intended to re-use the from work, it shall be cleaned and made good to the satisfaction of the Engineer- in- charge. After removal of form work and shuttering, the EXECUTIVE ENGINEER shall inspect the work and satisfy by random checks that concrete prosuded is of good quality.
- 3.3.9.3 Immediately after the removal of forms all exposed bolts etc. Passing through the cement member and used for shuttering or any other purpose shall be cut inside the cement concrete member to a depth of at least 25 mm. below the surface of the concrete and, the resulting holder be filled by cement mortar. All fins caused by from joints, all cavities produced by the removal of form ties and all other holes and depression, honeycomb



spots, broken edges or corners and other defects, shall be thoroughly cleaned, saturated with water and carefully pointed and rendered true with mortar of cement and fine aggregate mixed in the proportions used in the grade of concrete that is being finished and so as dry consistency as is possible to use. Considerable pressure shall be applied in filling and pointing to ensure thorough filling in all voids. Surfaces which are pointed shall be kept moist for a period of 24 hours.

- 3.3.9.4 If rock pockets/honeycombs in the opinion of the Engineer-in-charge are of such an extent or character as to effect the strength of the structure materially or to endanger the life of the steel reinforcement, he may declare portions of the structure affected.
- 3.4.0 Mode of measurement and payment :
- 3.4.1 The consolidated cubical contents of concrete work as specified in item shall be measured. The concrete laid in excess of section shown on drawings or as directed shall not be measured. No deductions shall be made for.
- [a] Ends of dis-similar materials such as joints, beams, posts, girders, rafters, purline, trusses, corbels and steps etc. upto 500 sq.cm. in section.
- [b] Opening upto 0.1 sq.m.
- [c] The volume occupied by reinforcement shall not be deducted from R.C.C. work.
- 3.4.2 The rate includes cost of all materials labour, tools and plant required for mixing, placing in position vibrating and compacting, finishing as directed, curing and all other incidental expenses for producing concrete of specified strength. The rate excludes the cost of form work.
- 3.4.3 The rate shall be for a unit of one cubic metre.

**ITEM NO.3A:-**

Providing & laying cement concrete 1:2:4 (1 cement:2 sand:4 graded stone agg. 20 mm nominal size) & curing comp. Includ. cost of form work but exclu. Cost of reinforcement for reinforced concrete work in :  
(A) foundation, footing, base of columns and mass concrete

Details specification same as per Item Description, Plain Concrete Works description, Latest Amendment, other details as per Item No.3 and as directed by Engineer-in-charge.

The rate shall be for a unit of one cubic metre.

**ITEM NO. 4 :-**

Providing form work of ordinary timber planking so as to give a rough finish including centering, shuttering strutting and propping etc. Height of propping and centering below supporting floor to ceiling and removal of the same for in site reinforced concrete and plain concrete work in [a] Foundation, footing Bases of columns [b] columns, [c] Beams [d] Slabs [e] Lintels [f] Chajjas [g] Staircases [h] Staircases Landings [i] Vertical and Horizontal fins [j] Mass concrete etc. comp.

4.1.0 Materials :

The shuttering to be provided shall be of ordinary timber planks and shall conform to M-26. The dimensions of scantlings and battens shall conform to the design. The strength of the wood shall not be less than that assumed in the design.

4.2.0 Workmanship :

4.2.1 The form work shall conform to the shape lines and dimensions as shown on the plans and be so constructed as to remain sufficiently rigid during the placing and compacting of the concrete. Adequate arrangements shall be made by the contractor to safe-guard against any settlement of the formwork during the course of concreting and after concreting. The form work of shuttering, centering, scaffolding, bracking etc. shall be as per design.

4.2.3 Cleaning and Treatment of forms :

4.2.3.1 All rubbish, particularly chippings shaving and saw dust shall be removed from the interior of the form before the concrete is placed and the form work in contact with concrete shall be cleaned and thoroughly wetted or treated. The surface shall be then coated with soap solution applied before concreting is done. Soap solution for the purpose shall be prepared by dissolving Yellow soap in water to get consistency of paint. Alternatively a coat of raw linseed oil or form oil of approved manufacturer may be applied in case steel shuttering is used. Soap solution or raw linseed oil shall be applied after thoroughly cleaning the surface.

4.2.3.2 Care shall be taken that the coating does not get on construction joint surface and reinforcement bars.

4.2.4 Stripping Time :

In normal circumstances and where ordinary cement is used forms may be struck after expiry of following period :

(a)	Side of wall columns and vertical faces of beam	24 to 48 hours
-----	---	----------------



(b)	Beams soffits (Props. left under	7 days
(c)	Removal of props under slabs	
	(i) Slabs spanning upto 4.5 m.	7 days
	(ii) Spanning over 4.5 mt.	14 days
(d)	Removal of props to beams and arches	
	(i) Spanning upto 6 mt.	14 days
	(ii) Spanning over 6 mt.	21 days

4.2.5 Procedure when removing the form work :

All form work shall be removed without such shock or vibrations as would damage the reinforced concrete surface. Before the soffit form work and struts are moved, the soffits and the concrete surface shall be exposed where necessary in order to ascertain that the concrete has sufficiently hardened.

4.2.6 Centering :-

4.2.6.1 The centering to be provided shall be got approved. It shall be sufficiently strong to ensure absolute safety of the form work and concrete work before, during and after pouring concrete. Watch should be kept to see that behaviour of centring and form work is satisfactory during concreting. Erection should also be such that it would allow removal of forms in proper sequence without damaging either the concrete or the forms to be removed.

4.2.6.2 The props of centring shall be provided on firm foundation or base of sufficient strength to carry the loads without any settlement.

4.2.6.3 The centring and form work shall be inspected and approved by the Engineer-in-charge before concreting. But this will not relieve the contractor of his responsibility for strength, adequacy and safety of form work and centering.

4.2.6.4 If there is a failure of form work or centering, contractor shall be responsible for the damages to the work, injury to life and damage to property

4.2.7 Scaffolding :-

4.2.7.1 All scaffolding, hoisting arrangement and ladders etc. required for the facilitating of concreting shall be provided and removed on completion of work by contractor at his own expense. The scaffolding hoisting arrangement and ladders etc. shall be strong enough to withstand all live, dead and impact loads expected to act and shall be subject to the approval of the Engineer-in-charge. However, contractor shall be solely responsible for the safety of the scaffolding, hoisting arrangements, ladders, work and workmen etc.

4.2.7.2 The scaffolding, hoisting arrangements and ladders shall allow easy, approach to the work spot and afford easy inspection.

4.2.7.4 The rate is applicable to all conditions of working The rate shall include the cost of materials and labour for various operations involved such as

- [a] Splayed edges, notching, allowance for overlaps and passing at angle, battens centring, shuttering, propping bolting, Nailing, wedging, easing, striking and removal.
- [b] Filletting to form stop chamfered edges of splayed external angles not exceeding 20 mm width to beams, columns and the like.
- [c] Temporary openings in the forms for pouring concrete, if required, removing rubbish etc.
- [d] Dressing with oil to prevent adhesion of concrete with shuttering, and
- [e] Raking or circular cutting.

4.2.8 Re-Use:- Before re-use all forms shall be inspected by Engineer-in-charge and their suitability ascertained. The forms shall be scarred, cleaned and joints gone over, repaired. Inside surface shall be retreated to prevent adhesion of concrete.

4.3.0 Mode of measurement and payment :

Form work shall be measured as the area in square metres of shuttering in contact with concrete except in the case of inclined member and portion curved profile and upper side in which case only area of underside shall be measured for payment.

Form work to secondary beams shall be measured upto the side of main beams but no deduction shall be made from the work of the main beams at the intersection point.

No deduction shall be made from the form work of a column at intersection of beams. The rate is for the completed item.

The rate shall be for a unit of one sq.metre.

**ITEMS NO. 5 :-**

Providing and laying ordinary cement concrete 1:1.5:3 [1 Cement, 1.5 coarse sand:3 graded stone aggregates 20 mm nominal size] and finishing smooth with cement plaster in cement mortar 1:3 and curing etc. completing, including the cost of form work but excluding the cost of reinforcement for R.C.C. work in upto two level [A]

**Columns:** [i] Having cross sectional area 0.05 to 0.08 sq.mt. [ii] Having cross sectional area more than 0.08 sq.mt. and upto 0.12 sq.mt. [iii] Having cross sectional area more than 0.12 sq.mt. and upto 0.18 sq.mt. [B] **Beams :** [i] Having cross sectional area 0.05 to 0.08 sq. meter. [ii] Having cross sectional area more than 0.08 sq.mt. upto 0.12





sq.meter. [iii] Having cross sectional area more than 0.12 sq.mt. and upto 0.18 sq. mt. [ C ] Slabs: [i] Slabs upto 8 cms.thickness [ii] Slabs having more than 8 cms. and upto 10 cms.thickness [iii] Slabs having more than 10 cms. and upto 13 cms. thickness [iv] Slab having more than 13 cms and upto 15 cms.thickness [D] Lintels: [E] chhajjas etc.comp.

5.1.0 Materials and workmanship:-  
The relevant specifications of Item No.3 shall be followed for concrete work and Item No. 4 shall be followed for form work and centering work. The relevant specification Item No. 15 shall be followed for the finishing work in mortar 1:3 [1 cement:3 fine sand] Before the Plastering is done. The surface of the concrete shall be raked roughened Punch for Proper bond Except the reinforced concrete works shall be carried out for the columns, beams slabs and lintels.

- [A] The cross sectional are of columns shall be Specified in item.
- [B] The cross sectional area of beam lintel shall be specified in item.
- [C] The thickness of the slabs shall be specified in the item.
- [D] The thickness of the lintel chhajjas shall be specified in the item.

5.2.0 Mode of measurement and payment :-

5.2.1 The Consolidated Cubical Contents of Concrete work as Specified in item shall be measured. The concrete laid in excess of sections shown on drawings or as directed shall not be measured. No. deductions shall be made for [A] Ends of dis-similar materials such as joints, bems, posts, girders, refters, purlin trusses, corbels and steps etc. upto 500 sq.cm. in section. [B] Opening upto 0.1 Sq.M.

5.2.2 The rate includes cost of all materials labour, tools and plant required for mixing, placing in position, vibrating and compacting, finishing as directed, curing and all other incidental expenses for producing concrete of specified strength. The rate include the cost of form work. [The rate also includes smooth plaster.]

5.2.3 The volume occupied by reinforcement shall not be deducted from R.C.C.work.

5.2.4 The rate shall be for a unit of one cubic metre.

#### ITEMS NO. 5A:-

Providing and laying ordinary cement concrete 1:2:4 [1 Cement, 2 coarse sand:4 graded stone aggregates 20 mm nominal size] and finishing smooth with cement plaster in cement mortar 1:3 and curing etc. completing. including the cost of form work but excluding the cost of reinforcement for R.C.C. work in upto two level [A] Columns: [i] Having cross sectional area 0.05 to 0.08 sq.mt. [ii] Having cross sectional area more than 0.08 sq.mt. and upto 0.12 sq.mt. [iii] Having cross sectional area more than 0.12 sq.mt. and upto 0.18 sq.mt. [B] Beams : [i] Having cross sectional area 0.05 to 0.08 sq. meter. [ii] Having cross sectional area more than 0.08 sq.mt. upto 0.12 sq.meter. [iii] Having cross sectional area more than 0.12 sq.mt. and upto 0.18 sq. mt. [ C ] Slabs: [i] Slabs upto 8 cms.thickness [ii] Slabs having more than 8 cms. and upto 10 cms.thickness [iii] Slabs having more than 10 cms. and upto 13 cms. thickness [iv] Slab having more than 13 cms and upto 15 cms.thickness [D] Lintels: [E] chhajjas etc.comp.

#### Details specification as item No.5 but read 1:2:4 instead of 1:1.5:3

#### ITEM NO.6 :-

Providing and laying cement concrete 1:1.5:3 [1 Cement, 1.5 coarse sand:3 graded stone aggregate 20 mm. nominal size) for reinforced concrete **chhajjas** not exceeding 10 cms. thickness upto floor two to level including finishing the exposed surfaces with cement mortar 1:3 (1 Cement, 3 fine sand) to give a smooth and even surface, Centering and from work and Curing complete, excluding cost of reinforcement etc. complete.

#### 6.1.0 MATERIALS AND WORKMANSHIP :-

The cement mortar shall conform to M-11. The relevant specification of Item No.3 shall be followed except that the reinforced concrete work shall be carried out for reinforced concrete chhajjas not exceeding 10 cms in thickness.

The specifications for form work and centering shall be as per Item No.4.

The finishing work in cement mortar 1:3 (1 Cement : 3 fine sand) shall be carried out as per specifications of Item No. 15 except that the proportion of mortar is C.M. 1:3 insted 1:4 before the plastering is done, the surface of the concrete shall be raked/punch for proper bond.

#### 6.2.0 MODE OF MEASUREMENT AND PAYMENT :

The relevant specifications of Item No.5 shall be followed the rate shall be for a unit of one cubic metre.

#### ITEM NO.7 :-

Providing & laying TMT/CRS bars steel reinforcement for R.C.C.work including bending, binding and placing in position complete upto floor two level etc.comp.

#### 1. MATERIALS

1.1 Mild steel bars shall conform to M-18 Thermo Mechanically Treated steel bars (high yield strength steel deformed bars) shall conform to M-18, Mild steel binding wires shall conform to M-21.

#### 2. WORKMANSHIP





- 2.1 The work shall consist of furnishing and placing reinforcement to the shape and dimensions shown as on the drawings or as directed.
- 2.2 Steel shall be clean and free from rust and loose mill scale at the time of fixing in position and subsequent concreting.
- 2.3 Reinforcing steel shall conform accurately to the dimensions given in the bar bending schedules shown on relevant drawings. Bars shall be bent cold to specified shape and dimensions or as directed, using a proper bar bender, operated by hand or power to attain proper radius of bends, bars shall not be bent or straightened in a manner that will injure the material. Bars bent during transportation or handling shall be straightened before being used on the work. They shall not be heated to facilitate bending. Unless otherwise specified for mild steel a "U" type hook at the end of each bar shall invariably be provided to main reinforcement. The radius of the bend shall not be less than straight part of the bar beyond the end of the curve shall be at least four times the diameter of the bar. In case which are not round and in case of deformed bars, the diameter shall be taken as the diameter of the circle having an equivalent effective area. The hooks shall be suitably encased to prevent any splitting of the concrete. The cold twisted steel bars shall be used without hooks at the ends. Deformed bars without hooks shall, however, comply with relevant anchorage requirements.
- 2.4 All the reinforcement bars shall be accurately placed in exactly the same position as shown on the drawings, and shall be securely held in position during placing of concrete by annealed binding wire not less than 1 mm. in size, and by using stay blocks or metal chair spacers, metal handers, supporting wires or other approved devices at sufficiently close intervals. Bars shall not be allowed to sag between supports nor displaced during concreting or any other operations of the work. All devices used for positioning shall be of non-corrodible material. Wooden and metal supports shall not extend to the surface of the concrete, except where shown on the drawings. Placing bars on layers of freshly laid concrete as the work progresses for adjusting bar spacing shall not be allowed. Pieces of broken stone or brick wooden blocks shall not be used. Layers of bars shall be separated by spacer bars, precast mortar blocks or other approved devices. Reinforcement after being placed in position shall be maintained in a clean condition until completely embedded in concrete. Special care shall be exercised to prevent any displacement of reinforcement in concrete already placed. To prevent reinforcement from corrosion, concrete cover shall be provided as indicated on drawings. All the bars are to be spliced and which are likely to be exceeding 10 days shall be protected by a thick coat of neat cement grout.
- 2.5 Bars crossing each other where required shall be secured by binding wires (annealed) of size not less than 1 mm. in such a manner that they do not slip over each other at the time of fixing and concreting.
- 2.6 As far as possible, bars of full length shall be used, in case this is not possible, overlapping of bars shall be done as directed. When practicable, overlapping bars shall not touch each other, but be kept apart by 25 mm. or 125 times the maximum size of the coarse aggregate whichever is greater between them. Where not feasible, overlapping bars shall be bound with annealed wires, not less than 1 mm. thick twisted tight. The overlaps shall be staggered for different bars and located at points, along the span where neither shear nor bending moment is maximum.
- 2.7 Wherever indicated on the drawings or desired by the Engineer-in-charge, bars shall be joined by couplings which shall have a cross section sufficient to transmit the full stresses of bars. The ends of the bars that are joined by coupling shall be upset for sufficient length so that the effective cross section at the base of threads is not less than the normal cross section of the bar. Threads shall be standard threads. Steel for coupling shall conform to I.S-226.
- 2.8 When permitted or specified on the drawings, joints of reinforcement bars shall be welded so as to transmit their full stresses. Welded joints shall preferably be located at points when steel will not be subjected to more than 75% of the maximum permissible stresses and welds so staggered that at any one section not more than 20% of the rods are welded. Only electric welding using a process which excludes air from molten and conforms to any or all other special provisions for the work shall be accepted. Suitable means shall be provided for holding bars securely in position during welding. It shall be ensured that no voids are left in welding and when welding is done in two or three stages, previous surface shall be cleaned properly. Ends of the bars shall be cleaned of all loose scale, rust, grease, paint and other foreign matter before welding. Only competent welders shall be employed on the work. The M.S. electrodes used for welding shall conform to I.S. 814. Welded pieces of reinforcement shall be tested. Specimen shall be taken from the actual site and their number and frequency of test shall be as directed.
3. **MODE OF MEASUREMENT & PAYMENT**
- 3.1 For the purpose of calculating consumption, wastage shall not be permitted beyond 7.5%. Excess consumption over 7.5% will be charged at penalty rate.
- 3.2 Reinforcement shall be measured in length including overlaps, separately for different diameters as actually used in the work. Where welding or coupling is resorted to, in place of lap joints, such joints shall be measured for payment as equivalent length of overlap as per design requirement. From the length so measured, the weight of reinforcement shall be calculated in tonnes on the same basis as per M-14 even though steel is supplied to the contractor by the department on actual weight. Length shall include hooks at the



ends. Wastage and annealed steel wire for binding shall not be measured and the cost of these items shall be deemed to be included in the rate for reinforcement.

- 3.3 The rate for reinforcement includes cost of steel binding wires, its transporting from departmental store to work site, cutting, bending, placing and fixing in position as shown on the drawings and as directed. It shall also include all devices for keeping reinforcement in approved position, cost of joining as per approved method and all wastage and spacer bars.

- 3.4 The rate shall be for unit of one Kg.

**Item No. 8 :**

Providing and constructing brick work using fly ash building bricks having crushing strength not less than 35 kg/sqcm. in foundation and plinth in cement mortar 1:6 (1 cement :6 fine sand) etc. comp.

8.1.0 MATERIALS

Water shall conform to M-1, Cement shall conform to M-3, Sand shall conform to M-6, Flyash Building Bricks shall conform to M-15(A), Cement mortar shall conform to M-11.

8.2.0 WORKMANSHIP

- 8.2.1 Proportion : The proportion of cement mortar shall be 1:6 (1 cement, 6 fine sand) by volume.

- 8.2.2 Wetting of bricks : The bricks required for masonry work shall be thoroughly wetted with clean water for about two hours before use or as directed. The cessation of bubbles, when the bricks are wetted with water, is an indication of thorough wetting of bricks.

- 8.2.3 Laying : Bricks shall be laid in English bond unless directed otherwise. Half or cut bricks shall not be used except when necessary to complete the bond. Closures in such case shall be cut to required size and used near the ends of the walls.

A layer of mortar shall be spread on full width for suitable length of the lower course. Each brick shall first be properly bedded and set home by gently tapping with handle of trowel or wooden mallet. Its inside face shall be flushed with mortar before the next brick is laid and pressed against it. On completion of course, the vertical joints shall be fully filled from the top with mortar.

The walls shall be taken up truly in plumb. All courses shall be truly horizontal and all vertical joint shall be truly vertical. Vertical joints in alternate course shall generally be directly one over the other. The thickness of brick course shall be kept in uniform.

The brick shall be laid with frogs up wards. A set of tools comprising of wooden straight edges, manson's spirit level, square half metre rub, and pins, string and plumb shall be kept on the site of work for frequent checking during the progress of work.

Both the faces of walls of thickness greater than 23 cms. shall be kept in proper place. All the connected brick work shall be kept not more than one metre over the rest of the work. Where this is not possible, the work shall be raked back according to bond (and not left toothed) at an angle not steeper than 45 degrees.

All fixtures, pipes, outlet of water, hold fasts of doors and windows etc. which are required to be built in wall shall be embedded in cement mortar.

- 8.2.4 Joints : Bricks shall be so laid that all joints are quite flush with mortar. Thickness of joints shall not exceed 12 mm. The face joints shall be raked out as directed by raking tool daily during the progress of work, when the mortar is still green so as to provide key for plaster or pointing to done.

The face of brick shall be cleaned the very day on which the brick work is laid and all mortar dropping removed.

- 8.2.5 Curing : Green work shall be protected from rain suitably. Masonry work shall be kept moist on all the faces for a period of seven days. The top of masonry work shall be kept well wetted at the close of the day.

- 8.2.6 Preparation of Foundation Bed : If the foundation is to be laid, directly on the excavated bed, the bed shall be levelled, cleared of all loose materials, cleaned and wetted before starting masonry.

If masonry is to be laid on concrete footing the top of concrete shall be cleaned and moistened. The contractor shall obtain the engineer's approval for the foundation bed, before foundation masonry is started. When pucca flooring is to be provided flush with the top to plinth, the inside plinth offset shall be kept lower than the outside plinth top by the thickness of the flooring.

- 8.2.7 Fixtures - The frames of doors, windows, cup-boards etc. shall be housed into the brick work at the correct location and level as directed. The heavy steel doors, window frames etc. shall be built in with brick work, but for ordinary steel doors and windows required opening for frames, hold-fasts etc. shall be left in the wall and frames embedded later on in order to avoid damage to the frames.

- 8.2.8 Scaffolding - Necessary scaffolding shall be provided. The supports of the scaffolding shall be sound and strong tied together with horizontal pieces, over which the scaffolding plunks shall be fixed. Simple scaffolding shall be allowed normally. In this case scaffolding hole shall rest in hole header horizontal course only. Minimum number of holes shall be left in brick work for supporting horizontal scaffolding poles. The contractor is responsible for providing and maintaining sufficiently strong scaffolding so as to withstand all loads likely to come upon it.

- 8.2.9 Packing out of Joints - For the face of brick work, where plastering is to be done, joints shall be raked out to a depth not less than thickness of joints. The face of brick work shall be cleaned and mortar dropping removed on very same day that brick work is laid.

- 8.3.0 MODE OF MEASUREMENTS & PAYMENT :



- 8.3.1 The measurements of this item shall be taken for the brick masonry fully completed for limiting dimensions not exceeding those shown on the plans or as directed shall be final.
- 8.3.2 No deductions shall be made from quantity of brick work. No extra payment will be made for embedding in masonry holes in respect of the following items ---
- i] Ends of joints, beams, posts, girders, rafters, purlins, trusses, corbel, steps etc. where cross sectional area does not exceed 500 Sq.Cm.
  - ii] Opening not exceeding 1000 Sq.Cm.
  - iii] Wall plate, sand bed plates, bearing of slab, chajjas, and like whose thickness does not exceed 10 Cms. and the bearing does not extend the full thickness of wall.
  - iv] Drainage holes and recesses for cement concrete blocks to embed hold fasts for doors, windows etc.
  - v] Iron fixtures; pipes upto 300 mm. dia. hold fasts of doors and windows built into masonry and pipes etc. for concealed wiring.
  - vi] Forming charges of section not exceeding 350 Sq.Cm. in masonry.
  - vii] Apertures for fire places, shall not be deducted nor shall extra labour required to make splaying of jambs, throating and making arches over the aperture be paid for separately.
- 8.3.3 The rate shall be for a unit of one cubic metre.

**Item No.9 :-**

Providing and constructing brick work using fly ash building bricks having crushing strength not less than 35 kg/sqcm. in super structure in cement mortar 1:6 (1 cement :6 fine sand) etc. comp.9.1.0

Materials :

Flyash Building Bricks shall conform to M-15(A). Cement Mortar shall conform to M-11.

**9.2.0 Workmanship :**

The relevant specifications of Item No. 8 shall be followed except that the masonry work shall be carried out above plinth level to floor two level i.e. for ground floor.

The frames of doors, windows, cupboards etc. shall be housed into the brick work at the correct location and level as directed. The steel doors, window frames etc. shall be built in with brick work, but for ordinary steel doors and windows required opening for frames, hold fasts etc. shall be left in the wall and frames embedded later on in order to avoid damage to the frames.

Necessary scaffolding shall be provided. The supports of the scaffolding shall be sound and strongly tied together with horizontal pieces, over which the scaffolding planks shall be fixed. Simple scaffolding shall be allowed normally. In this case scaffolding hole shall rest in hole header horizontal course only. Minimum number of holes shall be left in brick work for supporting horizontal scaffolding poles.

The contractor is responsible for providing and maintaining sufficiently strong scaffolding so as to withstand all loads likely to come upon it.

For the face of brick work, where plastering is to be done, joints of brick work shall be cleaned and mortar dropping removed on very same day that brick work is laid.

**9.3.0 Mode of measurements and payments :**

The masonry work of G.F. i.e. above plinth level to floor two level shall be measured and paid under this item. Brick work in parapet shall be included in the corresponding masonry item of story immediately below the floor above which the parapet is built.

No deductions shall be made from quantity of brick work. Not any extra payment made for embedding in masonry or making holes in respect of following items.

- (i) Ends of joists, beams, posts, girder, rafters, purlins, trusses, corbel, steps etc. where cross sectional area does not exceed 500 sq.cm.
- (ii) Openings not exceeding 1000 sq.cm.
- (iii) Wall plates and bed plates bearing of slabs, chhajjas and the like whose thickness does not exceed 10 cms. and the bearing does not extend to the full thickness of wall.
- (iv) Drainage holes, and recesses for cement concrete blocks to embed hold fasts for doors, windows etc.
- (v) Iron fixtures, pipes upto 300 mm dia hold fasts, for doors and window built into masonry and pipes etc. for concealed wiring.
- (vi) Forming chases of section of exceeding 350 sq.cm. in masonry.
- (vii) Apertures for fire places shall not be deducted nor shall extra labour required to make splaying of jambs, throating and making arches over the aperture be paid for separately.

The rate shall be for a unit of one cubic metre.

**ITEM NO.10 :**

Providing and constructing brick work using Flyash building bricks having crushing strength not less than 70 kg./sq.cm. for super structure above floor two level in cement mortar 1:6 (1 Cement : 6 fine sand) etc. comp.

**10.1.0 MATERIALS AND WORKMANSHIP :**

The relevant specifications of Item No.9 shall be followed except that the masonry work shall be carried out for super structure above floor two level.

**10.2.0 MODE OF MEASUREMENTS AND PAYMENT :**



The relevant specification of Item No.9 shall be followed for masonry work.

The extra payment shall be made for additional lift above floor two level to each additional floor over and above the rate of masonry work and shall be measured and paid under this item.

The rate shall be for a unit of one cubic metre per floor.

**ITEM NO.10A :**

Uncoursed rubble masonry with hard stone of approved quality in foundations and plinth in cement mortar 1:6 (1 Cement : 6 sand) including leveling up etc. complete.

10.1.0 MATERIALS AND WORKMANSHIP :

The relevant specifications of Item No.9 shall be followed except that the masonry work shall be carried out for super structure above floor two level.

10.2.0 MODE OF MEASUREMENTS AND PAYMENT :

The relevant specification of Item No.9 shall be followed for masonry work.

The extra payment shall be made for additional lift above floor two level to each additional floor over and above the rate of masonry work and shall be measured and paid under this item.

The rate shall be for a unit of one cubic metre per floor.

**Item No. 11 :**

Providing & Constructing Half brick masonry in Flyash building bricks having crushing strength not less than 70 Kgs. / Sq. Cm.in cement mortar 1:4 (1 cement; 4 coarse sand) with 2 Nos. of 6 mm dia mild steel bars after every three course embeded in cement mortar for super structure above plinth level upto floor two level as directed etc.comp.

11.1.0 MATERIALS

11.1.1 Flyash Building Brick shall conform to M-15, Water shall conform to M-1, Cement shall conform to M-3, Sand shall conform to M-6, Cement mortar shall conform to M-11.

11.2.0 WORKMANSHIP

11.2.1 Relevant specifications of bricks, wetting and laying of bricks, joints, curing etc. shall conform to item No. 9 except the brick work of half bricks shall be carried out.

11.2.2 Cement mortar used in masonry work shall be in proportion of 1 part of cement and 3 parts of sand by volume.

11.2.3 All bricks shall be laid stretcher wise, breaking joints with those in the upper and lower courses. The wall shall be taken truly plumb. All courses shall be laid truly horizontal and all vertical joints shall be truly vertical. the bricks shall be laid with frogs upwards. A set of masons tools shall be maintained on work as required for frequent checking.

11.3.0 MODE OF MEASUREMENTS & PAYMENTS

11.3.1 The half brick masonry work in foundation and plinth shall be measured under this item, the limiting dimensions shall not exceed those shown in the plan or as directed. Any work done extra over the specified dimensions shall be ignored.

11.3.2 The rates included laying of 2 Nos. of 6 mm M.S. bars after every three course.

11.3.3 The relevant specifications of Item No.9 shall be followed. The length shall be measured nearest to 1 Cm.

11.3.4 The rate shall be for a unit of 1 Sq.Mts.

**ITEM NO.12 :**

Providing and constructing half brick masonry in fly ash building bricks having crushing strength not less than 35 kg/sqcm. in cement mortar 1:4 (1 cement :4 coarse sand ) curing etc. comp.

12.1.0 MATERIAL AND WORKMANSHIP :

The relevant specification for Item No.11 shall be followed except that the masonry work shall be carried out in super structure above floor two level etc. complete.

12.2.0 MODE OF MEASUREMENTS AND PAYMENTS :

The relevant specifications of Item No.11 shall be followed. The payment shall be made for the half brick masonry work carried out above floor two level.

The rate shall be for a unit of one Sq.mt. per floor.

**ITEM NO.13 :-**

Providing and filling in foundation and plinth with yellow soil or selected soil in layers of 20 cm. thickness including watering ramming and consolidating etc.comp.

13.1.0 Materials :-

Murrum shall be cleaned, of good binding quality, and of approved quality obtained from approved pots/quarries of disintegrated rock which contain silicious material and natural mixture of clay of calcarious origin. The size of murrum shall not be more than 20 mm.

13.2.0 Workmanship:-

13.2.1 The murrum to be used for filling shall be free from salts, organic or other foreign matter. All clods of murrum shall be broken.

13.2.2 As soon as the work in foundation has been completed and measured the site of foundation shall be cleared of all debris, brick bats, mortar dropping etc. and filled with murrum in layers not exceeding 20 Cms. Each layers shall be adequately watered, rammed and consolidated before the succeeding layer is laid. The



- murrum shall be rammed with iron rammers where feasible and with the butt ends of crowbars, where rammer cannot be used.
- 13.2.3 The plinth shall be similarly filled with murrum in layers not exceeding 20 cms. adequately watered and consolidated by ramming with iron or wooden rammers. When filling reaches finished level, the surface shall be flooded with water for atleast 24 hours and allowed to dry and then rammed and consolidated.
- 13.2.4 The finished level of filling shall be kept to shape intended to be given to the floor.
- 13.2.5 In case of large heavy duty flooring like factory flooring, the consolidation may be done by power rollers, where so specified. The extent of consolidation shall also be as specified.
- 13.2.6 The excavated stuff of the selected type shall be allowed to be used in filling the trenches and plinth. Under no circumstances blackcotton soil shall be used for filling the plinth.
- 13.3.0 Mode of measurement and payment :-
- 13.3.1 The payment shall be made for filling in plinth and trenches. No deduction shall be made for shrinkage of voids if consolidated as instructed above.
- 13.3.2 The rate includes cost of collecting and carting murrum or selected murrum of approved quality with all lead and labour required for filling in trenches and plinth.
- 13.3.3 The rate shall be for a unit of one cubic metre.

**ITEM NO.14 :**

- Filling in trenches with available excavated earth in layer not exceeding 20 cm in depth consolidating each deposited layer by ramming & waetring
- 1.0 **FILLING AND DISPOSAL OF THE EXCAVATED STUFF :**  
The excavated stuff of the selected type shall be used in filling the trenches and plinth or leveling the ground in layers. Under no circumstances black cotton soil shall be used for filling the trenches and plinth. The earth to be used for filling shall be free from salts organic or other foreign matter. All clods of earth shall be broken. As soon as the work in foundation has been completed and measured the site of foundation shall be cleared of the debris, brick bats, mortar dropping and filled with earth in-layers not exceeding 20cms. Each layer shall be adequately watered, rammed and console-dated before the succeeding layer is alid. The earth shall be rammed with iron rammers where feasible and with the butt ends of crow-bere where rammers cannot be used. When filling reaches finised level. The surface shall be flooded with water for atleast 24 hours and allowed to dry and then rammed and consolidated.  
The blance of the excavated quantity shall be removed by the contractor from the site of work to a place as directed with lead upto 50 M. and all lift.
- 2.0 **MODE OF MEASUREMENTS AND PAYMENT :**
- 2.1 The payment shall be made for filling in plinth and trenches. No deduction shall be made for shrinkage or voids. If consolidated as instructed above.
- 2.2 The rate shall be for a unit of one cubic metre.

**Item No. 14A :-**

Filling for embankments with yellow soil in layers of 20 cm. thickness including watering, ramming and consolidating etc. complete. Contractor will be paid as per the difference of existing contour level as well as made up contour level.

Details specification same as per Item No.14 and as directed by Engineer-in-charge.

**Item No. 14B :-**

Filling for embankments with mixed soil in layers of 20 cm. thickness including watering, ramming and consolidating etc. complete. Contractor will be paid as per the difference of existing contour level as well as made up contour level.

Details specification same as per Item No.14 and as directed by Engineer-in-charge.

**Item No. 15 :-**

- Providing and applying 10mm. thick cement plaster in single coat on brick/concretewalls for plastering and finished even and smooth with a floating coat of near cement slurry mixed with proportion etc. complete in cement mortar 1:3 (1 cement : 3 sand )
- 15.1.0 **MATERIALS**  
Water shall conform to M-1. The cement mortar of proportion 1:3 shall conform to M-11.
- 15.2.0 **WORKMANSHIP**





- 15.2.1 Scaffolding - Wooden ballies, bamboos, planks, treatles and other scaffolding shall be sound. These shall be properly examined before erection and use. Stage scaffolding shall be provided for ceiling plaster which shall be independent of the walls.
- 15.2.2 Preparation of Background - The surface shall be cleaned of all dust, loose mortar droppings, traces of algae, afflorsence and other foreign matter by water or by brushing. Smooth surface be roughened by wire brushing if it is not hard and hacking if it is hard. In case of concrete surface, if a chemical retarder has been applied to the form work, the surface shall be roughened by wire brushing and all the resulting dust and loose particles cleaned off and care shall be taken that none of the retarders is left on the surface. Trimming of projections on brick/concrete surfaces where necessary shall be carried out to get an even surface.  
Raking of joints in case of masonry work where necessary, shall be allowed to dry out for sufficient period before carrying out the plaster work.  
The work shall not be soaked but only damped evenly before applying the plaster. If the surface becomes dry, such areas shall be moistened again.  
For external plaster, the plastering operation shall be started from top floor and carried downwards. For internal plaster, the plastering operations may be started wherever the building frame and cladding work are ready and the temporary supports of the ceiling resting on the wall of the floor have been removed. Ceiling plaster shall be completed before starting plaster to walls.
- 15.2.3 APPLICATION OF PLASTER  
The plaster about 15 x 15 Cms. shall be first applied horizontally and vertically at not more than 2 metres intervals over the entire surface to serve as gauge. The surface gauges shall be truly in place of the finished plastered surface. The mortar shall then be applied in uniform surface slightly more than the specified thickness then brought to a true surface by working a wooden straight edge reaching across the gauges with small upward and sideways movements at a time. Finally, the surface shall be finished off true with a trowel of wooden flat according as a smooth or a sandy granular texture is required. Excessive trowelling or overworking the float shall be avoided. All corners, arises, angles and junctions shall be truly vertical or horizontal as the case may be and shall be carefully finished. Rounding or chamfering, corners, junctions etc. shall be carried out with proper templates to the size required.  
Cement plaster shall be used within half an hour after addition of water. Any mortar or plaster which is partially set shall be rejected and removed forthwith from the site. In suspending the work at the end of the day, the plaster shall be left out clean to the line both horizontally and vertically. When recommencing the plaster, the edges of the old work shall be scrapped clean and wetted with cement putty before plaster is applied to the adjacent areas to enable the two to properly join together. Plastering work shall be closed at the end of the day on the body of the wall and nearer that 15 cms. to any corners or arises. It shall not be closed on the body of features such as plaster bands and cornices not at the corners or arrises. Horizontal points in plaster work shall not also occur on parapet tops and copings as those invariably lead to leakage. No portion of the surface shall be left out initially to be packed up later on.  
Each coat shall be kept damp continuously till the next coat is applied for a minimum period of 7 days. Moistening shall commence as soon as plaster is hardened sufficiently. Soaking or walls shall be avoided and only as much water as can be readily absorbed shall be used, excessive evaporation on the sunny or windward side of building in hot air to dry weather shall be prevented by hanging mattings or gunny bags on the outside of the plaster and keeping them wet.
- 15.3.0 MODE OF MEASUREMENTS & PAYMENT
- 15.3.1 The rate shall include the cost of all materials, labour and scaffolding etc. involved in the operations described under workmanship.
- 15.3.2 All plastering shall be measured in square metres unless otherwise specified. Length, breadth or height shall be measured correct to a centimetre.
- 15.3.3 Thickness of the plaster shall be exclusive of the thickness of the key i.e. grooves or open joints in brick work, stone work etc. or space between laths. Thickness of plaster shall be average thickness with minimum 10 mm. at any point on this surface.
- 15.3.4 This item includes plastering upto floor two level.
- 15.3.5 The measurement of wall plastering shall be taken between the walls or partition (dimensions before plastering being taken) for length and from the top of floor or skirting to ceiling for height. Depth of cover of cornices if any, shall be deducted.
- 15.3.6 Soffits of stairs shall be measured as plastering on ceilings. Blowing soffits shall be measured separately.
- 15.3.7 For jambs, soffits, sills etc. for openings not exceeding 0.5 Sq.Mts. each in area for ends of joints, beams, posts, girders, step etc. not exceeding 0.5 Sq.Mts. each in area for and for openings exceeding 0.5 Sq.Mts. and not exceeding 3 Sq.Mts. in each area deductions and additions shall be made in the following manner ---
- a) No deductions shall be made for ends of joints, beams, posts etc. and openings not exceeding 0.5 Sq.Mts. each and no addition shall be made for reveals, jambs, soffits, sills etc. of these openings for finish to plaster around ends of joints, beams, posts etc.





- b) Deduction for openings exceeding 0.5 Sq.Mts. but not exceeding 3 Sq.Mts. each shall be made as follows and no additions shall be made for reveals, jambs, soffits sills etc. of these openings --
- i) When both faces of all wall are plastered with same plaster, deduction shall be made for one face only.
- ii) When two faces of wall are plastered with different types of plaster or if one face is plastered and the other pointed, deductions shall be made from the plaster or pointing on the side of frame for doors, windows etc. on which width of reveals is less than that on the other side but no deduction shall be made on the other side. Where width of reveals on both faces of all are equal, deductions of 50% of area of opening on each face shall be made from areas of plaster and/or pointing as the case may be.
- 15.3.8 For openings having door frames equal to projecting beyond the thickness of wall, full deductions for opening shall be made from each plastered face of the wall.
- 15.3.9 In case of opening of area above 3 Sq.Mts. each deductions shall be made for opening but jambs, soffits and sills shall be measured.
- 15.3.10 The rate shall be for a unit of one Sq.Mts.

**ITEM NO.16 :**

Providing and applying 10 mm thick cement plaster in single coat on Brick/concrete structure for plastering above floor two level for every additional storey height and finished even and smooth with a floating coat of neat cement slurry height and finished even and smooth with a floating coat of neat cement slurry etc. comp. in cement mortar 1:3 (1 Cement : 3 sand) for wall.

**16.1.0 MATERIALS AND WORKMANSHIP :**

The relevant specifications of Item No.15 shall be followed for plastering work except that the whole work is to be carried out above floor two level.

**16.2.0 MODE OF MEASUREMENTS AND PAYMENT :**

The mode of measurements and payment shall be same as per Item No. 15

The extra payment shall be made over and above the floor two level, rate for every additional floor height.

The rate shall be for unit of one Sq.mt.

**ITEM No.17 :**

Providing and applying 10 mm thick cement plaster in single coat on ceiling and soffits of stairs for plastering upto floor two level and finished even and smooth with a floating coat of neat cement slurry etc. complete in cement mortar 1:2 (1 Cement, 3 sand)

**17.1.0 MATERIALS AND WORKMANSHIP :**

The relevant specifications of Item No.15 shall be followed for plastering work except that this work is for ceiling and soffits of stairs upto two floor level instead of plaster on walls.

The smooth concrete surface shall be suitably roughened to provide necessary bond before plastering.

**17.2.0 MODE OF MEASUREMENTS AND PAYMENT :**

The relevant specification of Item No.15 is shall be followed. The payment shall be made for a unit of one Sq.mt. of work done extra over and above the payment of plaster work on wall surfaces, shall be measured and paid under this item.

The rate shall be for a unit of one Sq.mt.

**ITEM No.18 :**

Providing and applying 10 mm thick cement plaster in single coat on ceiling and soffits of stairs for plastering above floor two level for every additional storey height and finished even and smooth with a floating coat of neat cement slurry etc. comp. in cement mortar 1:3 (1 Cement : 3 sand).

**18.1.0 MATERIALS AND WORKMANSHIP :**

The relevant specifications of Item No.17 shall be followed except that the whole work is to be carried out to above floor two level.

**18.2.0 MODE OF MEASUREMENTS AND PAYMENT :**

The mode of measurements and payment shall be same as per Item No.17.

The extra payment shall be made over and above the floor two level, rate for every additional floor height.

The rate shall be for a unit of one Sq.metre.

**ITEM NO.19 :-**

Providing and applying 20mm. thick sand faced cement plaster on walls or similar surfaces at all floor levels,consisting of 12mm average thick backing coat of C.M. 1:3 (1 cement :3 sand ) and 8mm thick finishing coat of C.M. 1:1(1 cement :1sand).

**19.1.0 Materials :-**

Water shall conform to M-1 cement mortar shall conform to M-11.

**19.2.0 Workmanship :-**

- 19.2.1 The work shall be carried out in two coats. The backing coat [basecoat] shall be 12 mm. thick in C.M. 1:3. The relevant specifications of Item No.15 shall be followed except that the thickness of back coat shall be 12 mm. average and the proportion shall be of cement mortar 1:3 [ 1 cement:3 sand]. Before the first coat hardens its surface shall be beaten up by edges of wooden tappers and close dents shall be made on the surface subsequent coat shall be applied after this coat has been allowed to set for 3 to 5 days, depending upon the weather conditions. The surface shall not be allowed to dry during this period.



The second coat shall be completed to 8 mm thickness in C.M. 1:1 as described above, including raising sand facing by bushing. The sample of sand face shall be got approved before the work is started. The whole work shall be carried out uniformly as per sample approved.

19.2.2 Curing :-

The curing shall be started overnight after finishing of plaster. The plaster shall be kept wet for a period of 7 days. During this period, it shall be protected from all damages.

19.3.0 Mode of Measurements and payment :-

19.3.1 The relevant specifications of Item No.14 shall be followed except that the sand face plaster in outside upto 10 m. above ground level shall be measured and paid under this item.

19.3.2 The rate shall be for a unit of one sq.metre.

**ITEM NO.19A :-**

Providing and applying Roller cement plaster on walls or similar surfaces consisting of 12mm. thick backing coat of c.m. 1:3 ( 1 cement : 3 sand ) and 8mm. thick finishing coat of c.m. 1:1 ( 1 cement : 1 sand ) etc. comp.  
ITEM SPECIFICATION AS PER ITEM NO: 19

**ITEM NO. 20 :-**

Providing 35 mm wide throating or plaster drip and molding it to R.C.C chajja etc. complete.

20.1.0 Materials :-

Water shall conform to M-1. Cement shall conform to M-3. Sand conform to M-6. Cement mortar shall conform to M-11.

20.2.0 Workmanship :-

The work shall be carried out as directed. The proportion of mix for finishing, touching shall be in C.M. 1:2 by volume. Curing shall be done for not less than 7 days. The work shall be carried out in best workman like manner. The throating or plaster drip and moulding shall be one centimetre in thickness.

20.3.0 Mode of Measurements and payment :-

20.3.1 The rate includes cost of all materials and labour required to complete the item.

20.3.2 The rate shall be for a unit of one R.M.

**Item No 21:-**

White washing with lime or any colour mix on ceiling and wall surface ( three coats ) to give an even shade including thoroughly brooming the surface to remove all dirt, dust, mortar drops and other foreign materials at all floors etc.comp.

21.1.0 MATERIALS

21.1.1 The clear colour shall be made from glue and boiling water. The mixture shall be suitably tinted where required for use under coloured distemper if directed. Glue shall conform to I.S. 852-1969 (Specifications for animal glue).

21.1.2 Lime used shall be freshly brunt class 'C' lime (fat lime) and white in colour conforming to I.S. 712-1973. Water shall conform to M-1. Best quality of gum shall be used in the preparation of white wash. Ultramarine blue or indigo shall conform to I.S. 55-1970 for points, and shall be used for preparation of white wash. Pigments, mineral colours, not affected by lime shall be used in preparing colour wash.

21.2.0 WORKMANSHIP

21.2.1 Preparation of white wash solution - The fat lime shall be slaked at site and shall be mixed and stirred with about five litres of water for 1 Kg. of unslaked lime to make a thin cream. This shall be allowed to stand for a period of 24 hours and then shall be screened through a clean coarse cloth. 4 Kg. of gum dissolved in hot water shall be added to each cubic metre of lime cream. Small quantity of ultramarine blue (upto 3 gms. per Kg. of lime) shall also be used, the solution shall be stirred thoroughly before use.

21.2.2 Preparation of Surface - The surface shall be thoroughly cleaned of all dust, dirt, mortar droppings and other foreign matter before white wash is to be applied.

The surface spoiled by smoke soot shall be scraped with steel wire brushes or steel scrapers or shall be rubbed with over burnt surkhi or brickbats. The surface shall be then broomed to remove all dust, dirt and shall be washed with clean water.

Oil or grease spots shall be removed by suitable chemical and smooth surface shall be rubbed with wire brushes.

All unsound portion of the surface plaster shall be removed to full depth of plaster in rectangular patches and plastered again after raking the masonry joints properly. Such portion shall be wetted and allowed to dry. They shall then be given one coat of white wash.

All unnecessary nails shall be removed, the holes, cracks, patches etc. shall be made good with materials similar in composition to the surface to be prepared.

21.2.3 Scaffolding - Where scaffolding is necessary it shall be erected in such a way that as far as possible no part of scaffolding shall rest against the surface to be white or colour washed. A properly secured strong and well tied suspended platform ( zoola) may be used for white washing. Where ladders are used, pieces of old



- gunny bags shall be tied at top and bottom to prevent scratches to the floors and walls. For white washing of ceilings, proper stage scaffolding shall be erected where necessary.
- 21.2.4 Application of White/Colour Wash - On the surface so prepared the white wash shall be applied with 'Moon' brush. The first stroke of the brush shall be from top downwards, another from bottom upwards over the first stroke and similarly one stroke from the right another from the left, over the first stroke brush before it dries. This will form one coat. Each coat shall be allowed to dry before the next coat is applied. The number of coats as specified in item shall be applied. It shall present a smooth and uniform finish free from brush marks and it should not come off easily when rubbed with fingers. Splashing and dropping if any on the doors and windows, ventilators etc. shall be removed and the surface cleaned.
- Priming and alkali resistant treatments, scrapping of surface, washing etc. surface spoiled by smoke & soot, removing of oil and grease spots treatment for infection with effluence moulds, moss, fungi, algae and lichen and patch repairs to plaster wherever done shall not be paid extra.
- 21.3.0 **MODE OF MEASUREMENTS & PAYMENTS**
- 21.3.1 All the works shall be measured in the decimal system as under ---
- a) Dimensions shall be measured to the nearest 0.01 M.
- b) Area in individual items shall be worked out to the nearest 0.01 Sq.M.
- All the works shall be measured in Sq.Mts. Deductions for jambs, soffits, sills etc. for openings not exceeding 0.5 Sq.Mts. each in area, for ends of joints, posts, beams, girders, steps etc. not exceeding 0.5 Sq.Mts. each in area and for openings exceeding 0.5 Sq.Mts. but not 3.0 Sq.Mts. each in area deductions and additions shall be made as under.
- 21.3.2 No deductions shall be made for ends of joints, beams, posts etc. and openings not exceeding 0.5 Sq.Mts. each. No additions shall be made for reveals, jambs, soffits, sills etc. of these openings not for finish around ends of joints, beams, posts, etc.
- 21.3.3 Deductions of openings exceeding 0.5 Sq. Mts. but not exceeding 3 Sq.Mts. each shall be made as follows and no additions shall be made for reveals, jambs, soffits etc. of these openings --
- a) When both the faces of walls are provided with finish, deduction shall be made for one face only.
- b) When each face of wall is provided with a different finish deduction shall be made for that side of frame for door, windows etc. on which width of reveals is less than that of the other side, where width of reveals on both faces of wall are equal, deduction of 50% of area of opening on each face shall be made from total area to finish.
- c) When only one face of wall is treated and the other face is not treated, full deduction shall be made if the width of reveal on the treated side is less than that on the untreated side, but if the width of the reveal is equal or more than on the untreated side neither deductions nor additions to be made for reveals, jambs, soffits, sills etc.
- 21.3.4 In case of area of openings exceeding 3 Sq.Mts. each, deduction shall be made for openings but jambs, soffits, sills shall be measured.
- 21.3.5 No deductions shall be made for attachment such as casing, conducts, pipe, electric wiring and the like.
- 21.3.6 Cornices and all other features, when they are not picked out in a different finish colour shall be girthed and included in the general area.
- 21.3.7 The rate shall include the cost of all materials, labour scaffolding, protective measures etc. involved in all the operations described above.
- 21.3.8 The rate shall be for a unit of one Sq.Mts.
- ITEM NO.22 :**  
Providing and applying white washing with lime on ceiling and / or sloping roofs. (three coats) to give even shade including thoroughly brooming the surface of remove all dist, dust, mortar drops and other foreign matter etc. compl.
- 22.1.0 **MATERIALS AND WORKMANSHIP :**  
The relevant specifications of Item No.21 shall be followed except that this work shall be carried out for ceiling and/or sloping roof.
- 22.2.0 **MODE OF MEASUREMENTS AND PAYMENTS :**  
The relevant specifications of Item No.21 shall be followed except that extra payment for white washing on coiling and/or sloping roof shall be measured and paid under this item.  
The rate shall be for a unit of one Sq.metre.
- ITEM NO. 23 :-**  
Providing and applying finishing wall with water proofing cement paint on surface [three coats ] to give an approved brand and manufacture and of required shape even shade after GATEE thoroughly brushing the surface to remove all dust dirt, and remains of loose powder material etc.comp.
- 23.1.0 **Material:-** The water shall conform to M-1 cement water proofing paint shall conform to I.S.5410-1992.
- 23.2.0 **Workmanship:-**
- 23.2.1 **Scaffolding -** Where scaffolding is necessary it shall be erected in such a way that as far as possible no part of scaffolding shall rest against the surface to be white or colour washed. A properly secured strong and well tied suspended platform ( zoola) may be used for white washing. Where ladders are used, pieces of old



- gunny bags shall be tied at top and bottom to prevent scratches to the floors and walls. For white washing of ceilings, proper stage scaffolding shall be erected where necessary.
- 23.2.2 Preparation of Surface :-The relevant specification of Item No. 21 shall be followed except that the work white wash shall be submitted with water proofing cement paint. The surface shall be thoroughly wetted with clean water before cement water proofing paint is applied.
- 23.2.3 Preparation of Paint :- Portland cement paint shall be prepared by adding paint powder to water and stirring to obtain a thick paste, which shall then be diluted to a brushable consistency. Generally, equal volumes of paint powder and water make a satisfactory paint. In all cases, the manufacturer's instructions shall be followed. The paint shall be mixed in such quantities as can be used up within an hour of mixing as otherwise the mixture will set and thicken, affecting flowing and finish. The lid of cement paint drums shall be kept tightly when not in use.
- 23.2.4 Application of paint :-  
No painting shall be done when the paint is likely to be exposed to a temperature of below 7°C within 48 hours after application.  
When weather conditions are such as to cause work to be carried out "in the shadow" as far as possible. This helps the proper hardening of the paint film by keeping the surface moist for a longer period.  
To maintain the uniform mixture and to prevent segregation, the paint shall be stirred frequently in the bucket.  
The surface shall be treated with minimum three coats of water proof cement paint. Not less than 24 hours shall be allowed between two coats. New coat shall not be started until the preceding coat has become sufficiently hard to resist marking by the brush being used. In hot dry weather, the preceding coat shall be slightly moistened before applying the subsequent coat.  
The finished surface shall be even and uniform in shade, without patches, brush marks, paint drops etc.
- The cement paint shall be applied with a brush with relatively short stiff hog or fibre bristles. The paint shall be brushed in uniform thickness and shall be free from excessively heavy brush marks. The lamps shall not be well brushed out.  
Water proof cement paint shall not be applied on surface already treated with white wash, colour wash, distemper dry or oil bound varnished paint etc. It shall not be applied on gypsum, wood and metal surfaces.
- 23.2.6.0 Curing :-
- 23.2.6.1 Painted surface shall be sprinkled with water two or three times a day. This shall be done between coats, and for at least two days following the final coat. The curing shall be started as soon as the paint has hardened so as not to be damaged by the sprinkling of water say about 12 hours after the application.
- 23.2.6.2 Protection measures shall be taken as per Item No.21.
- 23.3.0 Mode of measurements and payment :-  
The relevant specification of Item No.21 shall be followed. The rate shall be for a unit of one sq.metre.
- ITEM NO.24 :**  
Providing and applying finishing wall with water proofing cement paint on ceiling and sloping roofs (three coats) to give an approved brand and manufacturer and of required shape even shade after thoroughly brushing the surface to remove all dust dirt and remains of loose powder.
- 24.1.0 MATERIALS AND WORKMANSHIP :  
The relevant specifications of Item No.23 shall be followed except that this work shall be carried out for ceiling and/or sloping roof.
- 24.2.0 MODE OF MEASUREMENTS AND PAYMENT :  
The relevant specifications of Item No.23 shall be followed except that extra payment for applying cement water proofing paint on ceiling and sloping roof shall be measured and paid under this item.  
The rate shall be for a unit of one Sq.metre.
- ITEM No : 25 :-**  
Providing & fixing 35mm.th. Indian teak wood shutters for doors, windows & clearstory windows incl. Sal wood frames of finished size 12cm x 7cm.incl. Medium quality anodized aluminum fixtures & fastenings incl. Primer coat of approved quality & two coats of oil painting etc. For all Floor
- a] Fully Panelled]
- b] Partly pannelled and partly glazed windows.
- c] Fully glazed ventilators.
- 25.1.0 MATERIALS  
Wood for frame and shutter shall conform to M-29. Fixtures and fastening shall conform M-43. The ready mixed paint for brushing priming for enamels wood shall conform to I.S. 106-1962 and the paint shall conform to M-44 (the enamel paint shall conform to I.S. 133-1975).
- 25.2.0 WORKMANSHIP
- 25.2.1 The item covers the requirement of frames and shutters for doors, windows, clearstory windows, ventilators their supply and fixing.





- 25.2.2 Frames - All members of frames shall be exactly at right angles. The right angle shall be checked from inside surfaces of the respective members.  
All members of frames shall be straight without any warp or bow and shall have smooth surfaces well planned on the three sides exposed at right angles to each other. The surfaces touching the wall may not be planned unless it is required in order to straighten up the member or to obtain the overall sizes within the tolerances as specified.  
Frame shall have dovetail joints. When windows is included, it shall be provided by having full length one piece post for door or windows and clearstory window extending the frame on top at the head to the required extent. Horns shall not be provided in the head of the frame. When no sills are provided, the vertical posts of the frame in the ground floor shall be embedded in the sill masonry for 10 cm. on upper floors, the vertical posts shall be fixed in the floor or masonry by forming notches 10 mm. deep. Sight adjustment of spacing as necessary shall be done to have the holdfasts in the joints of masonry course. The frame shall be erected in position and held plumb with strong support iron both sides and built in masonry as it is being built. The transom shall be through tenoned in the mortices of the jamb post to the full width of the jamb post and the thickness of the tenon shall be not less than 15 mm.
- 25.2.3 Tolerance - Unless specially mentioned otherwise tolerance of 1.5 mm. shall be allowed for each wrought face.
- 25.2.4 The tenons shall be closely fitting into the mortices and suitably pinned with wood dowels not less than 10 mm. diameter. The depth of rebates for housing the shutter shall be as shown in the detail drawing or as directed.
- 25.2.5 The contact surface of tenon and mortise shall be treated before putting together with an adhesive of approved make.
- 25.2.6 Minimum number of three holdfasts shall be fixed on each side of door and window frames, one at the centre point and the other two at 30 cms. from the top and the bottom of the frames. In case of window and ventilator frames whose height is less than 1 M. two holdfasts, in each side shall be fixed at quarter points of the frames. The size of each holdfasts shall be 300 x 25 x 6 mm. and of mild steel with spit end. The holdfasts shall be fixed with screws to frames.
- 25.2.7 Mild steel hold fasts shall be protected with a coating of coal asphalt tar. The surface of frame abutting the masonry or concrete faces shall be properly treated by applying a coat of approved coating.
- 25.2.8 Shutters - Pannelled shutters shall be constructed in the form of timber frame work of styles and rails with panel inserted of type as specified in the detailed drawings. Panel shall be fixed by providing grooves in the styles and rails. The styles and rails shall be joined to each other by mortise and tenon joints at right angles. All members of the shutters shall be straight without any warp or bow and shall have smooth, well planned faces at right angles to each other.  
The size of styles and rails shall be as per drawings or as directed. Styles and rails of shutters shall be made of one piece only.
- 25.2.9 Timber Panelling - Thickness of the panel shall be as specified in the drawings or as directed. If the panel is made from more than one piece, the piece shall be finished as shown in the detailed drawings and shall be joined with continuous groove with specified size. The end pieces of the panel and the top and the bottom of the panel shall be provided with continuous tongue to frame into groove of the frame shutter. An air space of 1.5 mm. shall be left in the groove of frame of shutter while framing the panel in it.  
The faces of the panel as well as various pieces of the panel shall be closely fitted to the sizes of the grooves. Finishing of the corners or raised panel edge shall be done as shown in drawings or as directed.  
The thickness specified shall be finished thickness and no tolerance will be permitted.
- 25.2.10 Glazing - The glass panels shall be embeded in putty and secured to the rebate by wooden bends, or mouldings shape and size as approved with counter sunk screws of suitable size.  
The glass panel shall be properly cut to fit the rebate of the frames and sashes fully with a slight minus margin of about 1.5 mm. of all sides. Before glazing the frame shall be primed and prepared for painting so that wood may not draw oil out of putty. The rebate shall be putted to an extent to provide bedding all round the glass.  
The glass shall than be bedded in putty and fitted to frames with wooden beads or moulding as directed and screwed with wooden beads or moulding as directed and screwed with counter sunk screws. The screws shall be spaced not more than 100 mm. from each corner and nor more that 200 mm. apart.  
The size of the rebate in the frame and size and shape of beads or moulding shall be as per detailed drawing or as directed. The beads or mouldings shall have mitred corners.
- 25.2.11 Fixtures & Fastenings - All fixtures and fastening of approved quality shall be provided with necessary screws. The hinges, bolts and other items of iron mongery with moving part shall be properly oiled by the contractor before handing over the building.
- 25.2.12 Painting - The surface shall be cleaned and rubbed with sand paper to bring it in the one plane. When finished, no scratches from the sand paper should show. After preparing the surface, one coat of white paint shall applied as priming coat.  
Little white lead being worked in other mixing to help hardening of putty. The work shall be rubbed down smooth with sand paper and the consequent coats of paint of the specified shade approved by the Engineer-in-charge shall be applied.



The paints shall be applied with brush. It shall be spread as smoothly as possible. Final coat shall be very crossed and laid off, so that brush marks are not visible.  
Each coat of paint shall be allowed to dry thoroughly and shall be little rubbed in before the next one is laid.  
Finish surface shall not show any hair marks ridges or dry patches of paint and no puddles shall be left in the corners of panels, angles of the mouldings etc.

25.3.0 **MODE OF MEASUREMENTS & PAYMENTS**

25.3.1 For measurement, the dimensions shall be measured correct upto 1 cm. The quantity shall be worked out correct to 2 places of decimals for rounding.

25.3.2 The item includes all materials, labours and necessary iron oxidised fixtures and fastenings, oil painting in three coats of approved paint. The payment shall be made on Sq.Mts. basis.

25.3.3 The rate shall be for a unit of one square metre.

**ITEM NO.26 :**

Providing and fixing 35 mm thick shutter for doors, windows and clear story windows including salwood frames 12 cm x 7 cm. size including aluminum oxidized fixtures and fastening including primer coat of approved quality and two coats of oil painting etc. (I) Fully glazed.

26.1.0 **MATERIALS :**

Wood for frames and shutter shall conform to M-29. Glass shall conform to M-38, Fixtures and fastening shall conform to M-43. The ready mixed paint for brushing priming for enamels wood shall conform to I.S. 106-1962, and the paid shall conform to M-44. (the enamels paint shall conform to I.S. 133-1975.

26.2.0 **WORKMANSHIP :**

The relevant specification of Item No.25 shall be followed except that the 35 mm. thick shutters fully glazed for doors, windows and clerestory windows etc. as per drawings.

26.3.0 **GLAZING :**

The glass panels shall be embeded in putty and secured to the rebate by wooden beads, or moulding shape and size as approved with counter sunk screws of suitable size.

The glass panel shall be properly cut to fit the rebates of tee frames and sashes fully with a slight minus margin of about 1.5 mm. on all sides. Before glazing the frame shall be primered and prepared or painting so that wood may not draw oil out of putty.

The rebate shall be put to an extent to provide bedding all round the glass.

The glass shall then be bedded in putty and fitted to frames with wooden beads or moulding as directed and secured with counter sunk screws. The screws shall be spaced not more than 100 mm. from each corner and not than 200 mm apart.

The size of the rebate in the frame and size and shape of beads or moulding shall be as per detailed drawings or as directed. The beads or moulding shall have mitred corners.

26.4.0 **MODE OF MEASUREMENTS AND PAYMENT :**

The relevant specifications of item No.25 shall be followed.

The rate shall be for a unit of one sq.metre.

**ITEM NO.27 :**

Providing and fixing 35 mm thick shutter for doors, windows and clear storywindows including salwood frames 12 cm x 7 cm. size including alluminium oxidised fixtures and fastening including primer coat of approved quality and two coats of oil painting etc. (III) Partly panelled and partly glazed.

27.1.0 **MATERIALS :**

Wood for frames and shutter shall conform to M-38. Fixtures, and fastenings shall conform to M-43. The ready mixed paint for brushing priming for enamoils wood shall conform to I.S. 106- 1962 and the paint shall conform to (the enamels paint shall conform to I.S. 133-1975.

27.2.0 **WORKMANSHIP :**

The relevant specifications of Item No.25 shall be followed except windows and cleare storye window etc. as per drawing.

27.3.0 **MODE OF MEASUREMENT AND PAYMENT :**

The relevant specifications of Item No.25 shall be followed.

The rate shall be for a unit of Sq.metre.

**ITEM NO.28 :**

Providing and fixing 35 mm thick shutter for doors, windows and clear storywindows including Indian teak wood frames 12 cm x 7 cm. size including alluminium oxidised fixtures and fastening including primer coat of approved quality and two coats of oil painting etc. (I) fully glazed.

28.1.0 **MATERIALS AND WORKMANSHIP :**

The relevant specification of Item No.26 shall be followed except that the frame size be 12 cm x 7 cm etc.as per drawings.

28.2.0 **MODE OF MEASUREMENT AND PAYMENT :**

The relevant specification of Item No.26 shall be followed.





The rate shall be for a unit one Sq.metre.

**ITEM NO.29 :**

Providing and fixing 25 mm thick shutter for doors, windows and clear storywindows including Indian teak wood frames 12 cm x 7 cm. size including alluminium oxidised fixtures and fastening including primer coat of approved quality and two coats of oil painting etc. (II) fully panned

**29.1.0 MATERIALS AND WORKMANSHIP :**

The relevant specification of Item No.25 shall be followed except that the frame size be 12 cm x 7 cm etc.as per drawings.

**28.2.0 MODE OF MEASUREMENT AND PAYMENT :**

The relevant specification of Item No.25 shall be followed.  
The rate shall be for a unit one Sq.metre.

**ITEM NO.29A :**

Providing & fixing 35mm.th. Flush Door Solid Double Core type Both Face water proof Ply Vennered & 1.5 mm th.laminate shall be pasted on both side with adhesives as specified by the manufacturers. The laminate shall be as per approved shade & texture, of make incl. Sal wood frames of finished size 12cm x 7cm.incl. S.S. Hinges with nessary screws & Anodized aluminum fixtures & fastenings For all Floor

**29.1.0 MATERIALS AND WORKMANSHIP :**

The relevant specification of Item No.25 shall be followed except that the frame size be 12 cm x 7 cm etc.as per drawings.

**28.2.0 MODE OF MEASUREMENT AND PAYMENT :**

The relevant specification of Item No.25 shall be followed.  
The rate shall be for a unit one Sq.metre.

**ITEM NO.30 :**

Providing and fixing 35 mm thick Indian took wood shutter for doors, windows and clear storywindows including sal wood frames 12 cm x 7 cm. size including medium quality anodised aluminium fixtures and fastening including primer coat of approved quality and two coats of oil painting etc. (III) Fully panned.

**30.1.0 MATERIALS AND WORKMANSHIP :**

The relevant specification of Item No. 25 shall be followed except that the frame size be 12 cm x 7 cm etc.as per drawings.

**30.2.0 MODE OF MEASUREMENT AND PAYMENT :**

The relevant specification of Item No.25 shall be followed.  
The rate shall be for a unit one Sq.metre.

**ITEM NO.31 :**

Providing and fixing glazed louvered glass window and ventilators with sal wood frame 12 cm x 7 cm size including 3 coats of oil painting to wood work etc.

**31.1.0 MATERIALS :**

Sal wood shall conform to M-29 glass shall conform to M-38.

**31.2.0 WORKMANSHIP :**

The relevant specifications of Item No.25 shall be followed for frame work and painting. Ventilators shall be provided with glazed glass louvers. The glass louvers shall be provided as directed. In the groove of 1.25 cms depth made in frames, the thickness of glass shall be 5 mm and glass shall be of best quality. The Ventilation blades shall slope down towards the outside at an angle of 45 degree.

**31.3.0 MODE OF MEASUREMENTS AND PAYMENTS :**

The area of opening within the frame in which louvers are fixed shall be measured in Sq.metres. The rate includes painting 3 coats to wood work with ready mix paint.  
The rate shall be for a unit of one sq.metre.

**ITEM NO.31(A) :**

Providing and fixing standared extruded of aluminium section of size 61 x 37.0 x0.90 mm (of Jindal section no.14080, @ Wt. 0.471 Kg per mt) with colour powder coated alluminium frame for Lovered Glass ventilation with 4 mm thick Figured glass as details etc. complete for ventilation.

**31.1.0 MATERIALS :**

Aluminium frame shall conform to M-31, Glass shall conform to M-38.

**31.2.0 WORKMANSHIP :**

Ventilators shall be provided with glazed glass louvers. The glass louvers shall be provided as directed. Thickness of glass shall be 3 mm and glass best quality of bajari glass. The Ventilation blades shall slope down towards the outside at an angle of 45 degree.

**31.3.0 MODE OF MEASUREMENTS AND PAYMENTS :**

The area of opening within the frame in which louvers are fixed shall be measured in Sq.metres.  
The rate shall be for a unit of one sq.metre.

**ITEM NO.32 :**

Providing and fixing first class Indian teak wood 75 mm x 60 mm moulded hand rails in straight length complete, including primer coat and two coat of varnish etc. complete.

## 32.1.0 MATERIAL :

First class Indian teak wood shall conform to M-29.

## 32.2.0 WORKMANSHIP :

The teak wood hand rail shall of size 75 mm x 60 mm. The hand rail shall be prepared from first class Indian teak wood. The hand rail shall be moulded as per detail drawings. The hand rail shall be fixed in straight length as per detail drawings with screws. The relevant specifications of Item No.25 shall be followed except that the teak wood shall be for a railing of specified size and two coat of varnishing.

## 32.3.0 MODE OF MEASUREMENT AND PAYMENT :

The hand rail shall be measured in running metre.  
The rate shall be for a unit of one R.M.

**ITEM NO.33 :**

Providing and fixing M.S. Round or square bars with M.S. flats at required spacings in wooden frames of windows and clere windows etc. comp.

## 33.1.0 M.S. flats shall conform to M-18 and M-22 respectively.

## 33.2.0 WORKMANSHIP :

The M.S. bars shall be fabricated as shown in the drawing or as directed. It shall conform to I.S. 226-1975 and I.S. 961 and I.S. 1977-1975. The M.S. bars shall be fixed at the required spacing in mild steel flats after drilled holes in the latter.

The diameter and spacing these bars shall be as mentioned in the drawing of as directed. The bars shall be passed through drill holes drilled into the mild steel flats, fixed in the recessing the frames. The flats shall be fixed with iron screws.

## 33.3.0 MODE OF MEASUREMENTS AND PAYMENT :

The rate shall be for the M.S. round or square bars with M.S. flats provided and fixed in position as per the specifications for the completed item.  
The rate shall be for a unit of one Kg.

**ITEM NO.34 :-**

Providing and fixing M.S. Grill of required pattern to wooden frames of windows etc. with M.S. flats at required spacings and frame aaround square or round bars with round headed bolts and nuts or by screws etc. complete (A) Plain Grill

## 34.1.0 MATERIALS :

The structural steel shall conform to M-22.

## 34.2.0 WORKMANSHIP :-

The M.S. Grills shall be prepared as per the drawings or as directed for fixing to wooden frames of windows etc.

The grill shall be fabricated to the designs and pattern shown in the drawings and the weight shall be as directed, and the joints shall be revetted or welded as shown in the plan or as directed. The grill so formed shall be fixed into the strip frames of the windows etc. before they are erected in position. The outside strip frame of the grill shall be housed to its full thickness into the recess cut into the frame of the windows etc. The grill shall be fixed to the frame with number of bolts and nuts or screws viz. bolt nut/screw per 30 cm. of the length of outer strip subject to a minimum of 2 Nos. on such side of the frame or as indicated in the drawing or as directed.

The bolts and nuts or screws shall be counter sunk and shall be fixed with the top of their heads flush with the face of the frame strips.

## 34.3.0 MODE OF MEASUREMENT AND PAYMENT :-

The payment shall be made for weight of screws, bolts and nuts etc. only weight of grill shall be paid.  
The rate shall be for a unit one Kg.

**ITEM NO.34A :-**

Providing & fixing M.S.Grills of required pattern to wooden frames of windows etc. At all floor levels with M.S. flats at required spacing & frame around square or round bars with round headed bolts & round headed bolts and nuts or by screws incl. Priming coat of Red lead paint etc. comp. (A) Plain grill For all Floors

1. Relevant specifications given for above work as described shall be applicable to this item and Item No.34. The work shall be carried out as per specification of manufacturers.
2. The measurement shall be in Kg.



- 3 The rate includes cost of material, labour, transportation, scaffolding and preparing the surfaces by cleaning.

**ITEM NO.35 :-**

Providing & applying painting two coats at all floor levels on new steel other metal surface with synthetic enamel paint, brushing interior to give an even shade incl. cleaning the surge of all dirt, dust & other foreign matter etc. comp. (A) For plain grill for all floor

**35.1.0 Materials :**

- 35.1.1 The ready mixed primer, brushing red lead shall conform to IS 102:1972.  
35.1.2 The thinner (linsed oil) shall conform to IS 75:1973 if for any reason, thinning is necessary in a case of ready mix paint, the brand of thinner recommended by manufacturer shall be used.  
35.1.3 The enamel paints shall conform to M-44 B.

**35.2.0 Workmanship :****35.2.1 Preparation of surfaces :**

The surfaces before painting shall be cleaned of all rust, scale, dirt and other foreign matter sticking to it with wire brushes, steel wool, scrapers, sand paper etc. This surface shall then be wiped finally with mineral turpentine which shall also removed greas and perspiration of hand marks. The surface shall then be allowed to dry.

**35.2.2 Application of primer :**

After the preparation of the surface, the priming coat shall be applied immediately. The brushing operations are to be adjusted to the spreading capacity advised by the manufacturer of the particular primer. The paint shall be applied evenly and smoothly by means of crossing and laying off. The crossing and laying off consists of covering the area over with paint, brushing alternately in opposite directions, two or three times and then finally brushing lightly in a direction at right angles to the same. In this process no brush marks shall be left after the laying off is finished. The full process of crossing and laying will constitute one coat.

During painting, every time, after the priming coat has been worked out of the brush bristles or after the brush has been unloaded the bristles of the brush shall be opened up striking the brush against portion of the unpainted surface with the end of the bristles held at right angles to the surface, so that bristles thereafter will collect the correct amount of paint when dipped again in to a paint container. The primery coat shall be allowed to dry completely before painting is started.

No hair marks from the brush or clogging at paint puddles in the corner or panels angles of mouldings etc. shall be left on the work.

Special care shall be taken painting over bolts, nuts, rivets overlaps etc.

The container when not in use shall be kept close and free from air so that paint does not thicken and also shall be kept guarded from dust.

**35.2.3 General :**

The materials required for painting work shall obtained directly from approved manufacturers are approved dealer and brough to the site in maker's drums, bogs etc. with seal unbroken.

All materials not in actual use shall be kept properly protected lid of containers shall be kept closed and surface of paint in open or partially open containers covered with a thin layer of turpentine to prevent formation of skin. The materials which have become state or flat to improper and long storage shall not be used. The paint shall be stirred throughly in its container before pouring into and shall be continuously stirred in smaller container. No left over paint shall be put back into stock tins. When not in use the containers shall be kept properly closed.

If for reason, thinning is necessary, the brand of thinner recommended by the manufacturer shall be used.

The surface to be painted shall be throughly cleaned and dusted. All dust, dirt and greas shall be throughly removed before painting is started. No painting on exterior or other exposed parts of the work shall be carried out in wet, damp or otherwise unfavourable weather and all the surface shall be throughly dried before painting work is started.

**35.2.4 Application of paint :**

Brushing operations are to be adjusted to the spreading capacity advised by the manufacturer of particular paint. The paint shall be applied evenly and smoothly by means of crossing and laying off. The crossing and laying off consists of covering the area over with paint, brushing the surface hard for the first time over and then brushing alternately in opposite directions to or three times and then finally brushing lightly in direction at right angles to the same. In this process no brush marks shall be left after the laying off is finished. The full process of crossing and laying off will constitute one coat.

Each coat shall be allowed to dry completely and lightly rubbed with every fine grade of sand paper and loose particles brushed off before next coat is applied. Each coat shall vary slightly in the shade and shall be get approved from Engineer-in-charge before next coat is started.



Each coat except the last coat shall be lightly rubbed down with sand paper or fine pumicestone and cleaned of dust before the next coat is applied. No hairmarks from the brush or clogging of paint puddles in the corners of panels, angles of moulding etc. shall be left on the work.

Special care shall be taken while painting over bolts, nuts, rivets, overlaps etc. Approved quality brushes shall be used.

35.3.0 Mode of measurement and payment :

The new steel and other metal surface shall be measured under this item.

All the work shall be measured net in the decimal system as executed subject to the following limits unless otherwise stated hereinafter.

(a) Dimensions shall be measured to the nearest 0.01 mtr.

(b) Areas shall be worked cut to the nearest 0.01 sq.metre.

No. deductions shall be made for openings not exceeding 0.5 sq.metre each and no addition shall be made for painting to beadings mouldings, edges, jambs, soffits, sills etc.of such openings.

In case of fabricated structural steel and iron work,priming coat of paint shall be included with fabrication. In case of trusses if measured in sq.m. compound grids, stanchions, lattices, girder and similar work, actual area shall be measured in sq.m.and no extra shall be paid for painting on bolts, heads, nuts, washers, etc. No addition shall be made to the weight calculated for the purpose of measurements of steel and iron works for paint applied on shop or at site.

The different surfaces shall be grouped into one general item. Areas of uneven surface being converted into equivalent paint areas in accordance with the table given as per Annexure-II for payment.

The rate is for complete item as specified i.e. one primer coat and two coats of oil paint.

The rate shall be for a unit of one sq.meter.

ANNEXURE-II

Equivalent plain Area of a uneven surface (Vide specifications for item relevant to paint and polishing)

Sr. No.	Description of work	How measured	Multiplying factor
1.	Pannelled or framed and braced of ledged and battened or ledged and braced joinery cleats etc. shall be deemed to be included in the item.	Measured flat (not girthed) including chowkhat or frame. Edges, chocks,	1.30 For each side)
2.	Flush joinery	Measured flat (not girthed) including chowkhat or frame, Edges, Chocks, cleats, etc. shall be deemed to be included in the item.	1.20 For each side)
4.	Fully glazed hauzed joinery	Measured flat (not girthed) including chowkhat or frame, cleats, etc. shall be deemed to be included in the item.	0.80 For each side)
4.	Partly panelled and partly glazed of or glazed journey.	Measured flat (not girthed) including chowkhat or frame etc. shall be deemed cleats, Edges, chocks to be included in the item.	1.0 For each side)
5.	Full Ventilationed or or louzered jonery.	Measured flat (not girthed) including chowkhat or cleats etc. shall be deemed to be included in the item.	1.0 For each side)
6.	Weather boarding	Measurement flat (not girthed) supporting frame work shall not be measured separately.	1.2 For each side)
7.	Wood Shingle roofing	Measurement flat (not girthed)	1.0 For each side)
8.	Boarding with cover fillets and match boarding.	Measurement flat (not girthed)	1.05 For each side)
9.	Tile & slate work one way or two way	Measurement flat over all no deduction shall be made painting for open spaces. supporting over) members shall not be measured separately.	0.08 For each side)
10.	Trellies ( or Jafri ) work one way or two way for the open spaces	Measured flat over all no deduction shall be madesupporting members shall not be measured separately.	1.00 for painting cover



11.	Guard bars balustrades, rades, gates gratings, grills, expanded metal and railings	Measured flat over all No deduction shall be made for open spaces, supporting members shall not be measured separately.	1.00 for painting cover
12.	Gates and open palisade fencing including standards.	Measurement flar over all No deductions shall made for open spaces.supporting members shall not be measured separately	1.00 for painting cover
13.	Curved or enriched work	Measured flat over all no no deductions shall be made for open spaces supporting members shall not be measured separately	2.0 (For each side)
14	Steel roller shutters.	Measured flat (size of opening) over all, jamb guides, bottom rails and locking arrangement etc. shall be included in the item (top cover shall be measured seperately).	1.10(for each side)
15.	Plaing sheet steel door and windows)	Measured flat (not girthed) including frame	1.10(for each side)
16.	Fully glazed or gauzed steel door & windows.	Measured flat (not girthed)including frame edges etc.	0.60(for each side)
17.	Partly panelled and partly glazed or gauzed steel doors	Measured flat (not girthed) including frame edges etc.	0.80(for each side)
18.	Collapsible gate	Measured flat (size of opening No separate measurements shall be taken for the top and bottom guide rails, rolls, fittings etc.	1.0 for painting all over

Note : The height shall be taken from the bottom of the lowest rail if the palisades do not go below it (or from the lowerened of palisades, if they protect below the lowest rail) upto the top of palisades but not upto the top of standards if they are higher than the palisades.

#### ITEM NO.35A:

Providing and applying wall Painting with two coats of acrylic emulsion plastic paint of approved brand over existing surface to give an even shade & surface free from mortar dropping & other foreign matter & sand papered smooth etc. comp.

The brand of the paint shall be as specified and ready made paint of the required colours shall be used. If thinning is required pure potable water may be added to the required extent. The water used for thinning should be pure and free from floating or suspended debris. It should be free from any of impurity. The surface shall be made perfectly dry and smooth by rubbing with sand paper of the different grades. All holes and open joints in wood or walls shall be filled with strong putty or with a mixture of glues and plaster of paris and smoothened by rubbing with fine grade sand paper.

All the surface should be first painted with cement primer of approved make over which three/two coats of Acrylic emulsion of approved quality and make be applied so as to give smooth finished surface. The shade of the Acrylic Emulsion shall have to be get approved from the Dy.Engineer (Housing) or his representative.

The paint shall be applied with brushes evenly and smoothly. The paint should be stirred in the container immediately before use. The whole work shall have to be carried out to the entire satisfaction of the Engineer-in-charge or his representative.

Patch work or different in colour shades will not be tolerated in such case, extra one coat shall have be applied for which not extra payment shall be made.

Item includes preparation of base, scaffolding using every thing and dismantled with labour, materials, tools, paints required for satisfactorily completion of work.

Rate shall be per square metrer basis for complete item.

#### ITEM NO.36 :-





Providing and fixing upto floor two level precast cement concrete jali or grill 1:2:4 (1 cement : 2 coarse sand : 4 graded stone aggregate 6 mm nominal size) reinforced with 1.6 mm dia mild steel wire including roughening, cleaning fixing and finishing in cement mortar 1:3 and curing etc. complete (A) 50 mm thick (B) 40 mm thick (C) 25 mm thick (D) 75 mm thick (E) 100 mm thick.

36.1.0 Material :

Water shall conform to M-1 cement shall conform to M-3, sand shall conform to M-6. Mortar shall conform to M-11. Aggregates shall conform to M-12. Mild steel wire shall conform to M-21. shuttering shall conform to M-26.

36.2.0 Workmanship :

It shall be of cement concrete 1:2:4 (1 cement : 2 coarse sand : 4 graded stone aggregates ( 6 mm nominal size ) reinforced with 1.6 mm dia Mild steel wire unless otherwise specified.

The thickness of the jali shall be as specified in the item.

The Jali shall be set in position true to line & level before the jambs sills and soffits of the opening are plastered. It shall then be properly cemented with cement mortar 1:3 ( 1 cement : 3 sand ) and rechecked for levels. Finally the jambs, sills and soffits shall be plastered gripping the jali uniformly on all sides.

36.3.0 Mode of Measurements and payment :

The item shall be measured in square metre.

The rate shall be for a unit of one sq.metre.

**ITEM NO.37 :**

Providing and fixing above floor two level precast cement concrete jali or grill 1:2:4 (1 Cement : 2 coarse sand : 4 graded stone aggregate 6 mm nominal size) reinforced with 1.6 mm dia mild steel wire including roughening cleaning, fixing and finishing in cement mortar 1:3 and curing etc. complete (A) 50 mm thick (B) 40 mm thick (C) 25 mm thick (D) 75 mm thick (E) 100 mm thick.

37.1.0 MATERIALS AND WORKMANSHIP :

The relevant specifications of Item No.36 shall be followed except that the whole work is to be carried out above floor two level.

37.2.0 MODE OF MEASUREMENTS AND PAYMENTS :

The mode of measurements and payments shall be same as item No.36.

The extra payment shall be made over and above the floor two level rate for every additional floor height.

The item shall be measured in Sq.mt.

The rate shall be for a unit of one Sq.metre.

**ITEM NO.38 :**

Providing and fixing precast concrete block masonry in partition walls 10 cm thick with solid block of approved size (including quoins blocks, jambs blocks, closer etc.) made of c.c. 1:3:6 (1 Cement : 3 coarse sand : 6 graded stone aggregate 20 mm and down gauge) etc. complete. (A) In C.M. 1:4 for upto floor two level.

38.1.0 MATERIALS :

(a) Aggregate shall conform M-12 (b) Sand shall conform to M-6. (c) Cement shall conform to M-3 (d) Cement mortar of proportion 1:4 shall conform to M-1.

The solid cement concrete block shall be precast with concrete of 1:3:6 (1 Cement : 3 coarse sand : 6 graded stone aggregate) A block shall be deemed, to be solid if the solid materials is not less than 75% of the total volume of the block calculated from overall dimension.

The concrete mix used for blocks shall not be richer than 1 part by volume of cement to 6 parts by volume of combined aggregate.

The actual size of the block, shall be one of the following . Size : A) 39 x 30 x 19 cms.

B) 39 x 20 x 19 cms.

C) 39 x 10 x 19 cms.

The size other than specified above may be used with the approval of Engineer-in-charge.

The block may be either machine made or hand made. The concrete mix, the mixing of concrete, the manufacture of blocks, curing and drying shall be in accordance with para-6 to 10 under I.S. 2185-1967.

Faces of blocks shall be flat and rectangular surface finish shall be rendered smooth or plastered with cement mortar 1:4 (1 Cement : 4 coarse sand).

The average compressive strength of eight blocks when determined in the manner described in I.S. 2185-1967 shall not be less than 50 kg/sq.cm. of gross area. The strength of lowest individual block shall not be less than 75 percent of average compressive strength of eight blocks.

Concrete blocks shall be stored and stacked properly in such way as to avoid any contact with moisture at site. They shall be stock piled on planks or other supports free from contact with ground and covered to protect against wetting.

38.2.0 WORKMANSHIP :

The blocks need be wetted before or during laying in the walls, In case climatic conditions so required the top and the sides of block may only be slightly moistured so as to prevent absorption of water from the mortar and ensure the development of required bond with mortar.



Operations of laying precast cement concrete block masonry shall be carried out in accordance with instructions detailed in I.S. 6062-1962. The mortar shall not be spread so much ahead of the actual laying of the unit that it tends to stiffen and lose its plasticity thereby resulting in poor bond. For moist of the work, the joints, both horizontal and vertical shall be 10 mm thick except in the case of extended joint construction.

The joints shall be struck of flush with wall surface and the mortar has started stiffening it shall be compressed with rendered or U shaped tool. The mortar shall be pressed against the units with a jointing tool after the mortar has stiffened in effect intimate contact between the mortar and the masonry unit and obtained a weather tight joint.

Quoins & Closers :

Special quoins blocks (with a return face equal to half the length of normal face) shall be cast for all building blocks and slabs for external work proper half length closers shall be cast and not cut from full size blocks. The returned ends of blocks for door and windows reveals and quoins shall be finished with a fair face in the mould.

Only double scaffolding shall be used. The scaffolding shall be strong and sound. No Holes in the masonry for supporting scaffolding shall be allowed.

Curing :

The curing of concrete block masonry shall be carried out for days.

38.3.0 MODE OF MEASUREMENTS AND PAYMENTS :

All, work shall be measured on the basis of finished dimensions and measured not except where otherwise specified. Only specified dimensions shall be allowed. Anything extra shall be ignored. No deduction shall be made, nor extra payment made for the following :

- a) Ends of joints, beams posts, girders rafters, purlins trusses, corbels, etc. each upto 500 Sq.cm. in section.
  - b) Opening each upto 0.1 Sq.m.
  - c) Wall plates and bed plates, bearings of chhaja and like upto 10 cm. depth (bearing of floor and roof slabs shall be deducted from masonry)
  - d) Drain holes and recesses for cement concrete blocks to embed hold fasts for doors and windows.
  - e) Building in the masonry iron fixtures pipes upto 300 mm dia hold fasts of doors and windows.
  - f) Forming chases in masonry upto section of 350 Sq.cm.
- The rate shall be for a unit of one Sq.metre.

**ITEM NO.39 :**

Providing and fixing pre-cast concrete block masonry in partition walls 10 cm thick with solid block of approved size (including blocks, jamb block, closer etc.) made of c.c. 1:3:6 (1 Cement : 3 coarse sand : 6 graded stone aggregate 20 mm and down gauge) etc. complete for above floor two level (A) in C.M. 1:4

39.1.0 MATERIALS AND WORKMANSHIP :

The relevant specification of Item No. 38 shall be followed except that the work shall be carried out for super structure above floor two level.

39.2.0 MODE OF MEASUREMENTS AND PAYMENTS :

The relevant specifications of Item No.38 shall be followed. The extra payment shall be made for addition lift above floor two level to each additional floor over and above the work and shall be measured and paid under this item.

The rate shall be for a unit of one Sq.metre.

**ITEM No.40 :-**

Providing and fixing M.S. fan clamps at all floor levels type 1 of 12mm dia, M.S. bar bend to shape with hooked ends to R.C.C. slabs during laying all as per standard design etc. comp. (MR)

40.1.0 Materials :

M.S.Bar shall conform to M-18.

40.2.0 Workmanship :

The shape and size of fan clamps shall be as directed.

For fixing M.S.fan clamps in existing R.C.C.slab a case of size 150 mm x 75 mm shall be cut from the ceiling so as to expose the reinforcement and upto 25 mm clear round the reinforcement bar.This shall be done without any damage to adjoining portion of ceiling. The the arms of the ends of the clamp shall be passed through the space over reinforcement bar from the bottom of the slab. Then the two arms shall be bent down about 15 mm by means of crow bar. The clamp shall be held in position and the case in the ceiling filled with cement concrete 1:2:4 ( 1 cement : 2 coarse sand : 4 graded stone aggregate 20 mm nominal size). The ceiling shall be then finished to match the existing surface and properly cured. The item also includes the painting of the exposed portion of the lopp, as per standard specification of painting work.

40.3.0 Mode of Measurement and Payments :

The rate includes cost of all materials and labour required for satisfactory completion of this item as described above.

The rate shall be for a unit of one number.

**ITEM No.41 :-**



**Providing and laying chequered precast concrete tiles 22mm thick with aggregate of sizes upto 6mm in floors treads of steps and landing on 20mm thick bed of C.M. 1:6 (1 cement : 6 sand) or L.M. 1:1.5 (1 Lime putty : 1.5 sand) jointed with neat cement slurry with pigments to match the shade of the tiles.**

- 41.1.0 **Materials :**  
Water shall conform to M-1 cement shall conform to M-3. Lime Mortar shall conform to M-10. Cement mortar shall conform to M-11. The chequered precast concrete tiles of 20 mm. thick shall be of light shade using white cement and conform to M-47.
- 41.2.0 **Workmanship :**
- 41.2.1 The work shall be carried out as per I.S.1443-1972.
- 41.2.1 **Bedding :**  
Before spreading the mortar, the sub-base of the floor shall be cleaned of all dirt, scum and loose materials and then well wetted without forming any pools of water on the surface.  
In case of R.C.C. floors, the top shall be left a little rough, all points of level for the finished surface shall be marked out. The lime water of proportion 1:6 (1 cement : 6 coarse sand) jointed with neat cement slurry mixed with pigment to match the shade of the tiles as directed shall be then evenly and smoothly spread over the base. Bedding layer or mortar shall be not less than 10 mm and average thickness of bedding shall be 25 mm.
- 41.2.2 **Laying :**  
Before laying the terrazzo (Marble/Mosaic) tiles, the tiles shall be thoroughly wetted with water. Neat cement grout of required consistency at 4.4 kg.cement/sq.mt. shall be spread on the mortar bed. The tiles shall be laid on the neat cement float and shall be evenly and firmly bedded to the required level and slopes. There shall be no hollows left. The joints shall be of uniform thickness and in straight line as per the pattern.  
The surface of flooring shall be checked frequently with a straight edge at least two metres long so as to obtain a true surface with required slope.  
The tiles which are fixed in the adjoining wall shall go about 10 mm under plaster. Skirting or dedo shall be left unfinished for about 50 mm above finished floor level and unfinished strip then left earlier shall be finished.  
In places where full tiles can not be fixed. The tiles shall be cut to the size and smoothed at edges to give straight and true joints.  
After the tiles have been laid, the surplus cement slurry and the joints shall be cleaned and washed fairly deep before cement hardens.  
The day after tiles have been laid, the joints shall be cleaned of every cement grout with a wire brush to a depth of about 5 mm and then grouted with white cement with or without pigment to match the shade of the topping of tiles.
- 41.2.4 **Curing :**  
The flooring shall be kept wet with damp sand or water for seven days. It shall be kept undisturbed at least for 14 days. The grinding shall normally be commenced after 14 days.
- 41.2.5 **Polishing :**  
After the tiles are properly cured, first grinding shall be done with carborundum stone of 48 to 60 grade grit fitted in machine. Water shall be properly used during grinding. When the chips show up and the floor has been uniformly rubbed, it shall be cleaned with water, baring all pin holes. It shall then be covered with a thin coat of white cement mixed with or without pigments to match the colour of the topping of the tiles. Pin holes if any shall thus be filled. This grout shall be kept moist for a week. Thereafter second grinding shall be started with carborundum of 120 grit. Grouting and curing shall follow again. Final grinding shall be done when other works are finished. The machine shall be fitted with carborundum of grit 220 to 350 using water in abundance. The floor shall then be washed clean with water. Oxalic acid powder shall then be dusted at 33 grams per square metre on the surface and the surface rubbed with machine fitted with hessian bobs or rubbed hard with pad of wooden rags. The floor shall then be washed clean and dried with a soft cloth or Linen. The finished floor shall not sound hollow when tapped with a mallet.  
If any tiles is disturbed or damaged it shall be refitted or replaced properly jointed and polished.  
Testing of the tiles shall be carried out by the contractor at his own cost as per I.S. requirement for required tests.
- 41.3.0 **Mode of Measurements and payment :**  
The terrazzo tiles flooring shall be measured in Sq. metre for visible area of work done.  
No deductions shall be made nor extra paid for any opening in the floor area upto 0.1 Sq. mt. Nothing extra shall be paid for use of cut tiles or for laying the floors at different levels in the same room or court yard. Mosaic tiles laid in floor borders and bands etc. shall be measured in the same item and nothing extra shall be payable on account of these or similar bonds formed of half or multiples of half size, standard tiles or other uncut tiles.  
The treads of stairs and steps paved with tiles without nosing shall also be measured under this item.  
Extra rate shall however be paid for such area where width of treads does not exceed 30 cms.  
The rate shall include the cost of all materials, labour involved in all the operations as described above.  
The rate shall be for a unit of one sq. metre.

**ITEM NO. 42 :**

Providing and laying precast tarrazo tiles (Super/Vyara make) 20 mm thick with white black or white and black or of the colour specification of tender item marble chips of sizes upto 6 mm laid in floors treads of steps and landing on a bed of 25 mm thick of Lime mortar 1:1.5 (1 Lime putty : 1.5 sand) or of C.M. 1:6 joined with neat cement slurry mixed with pigment to match the shade of tiles including rubbing and polishing complete with precast tiles of dark shade using ordinary cement.

**42.1.0 MATERIALS AND WORKMANSHIP :**

The relevant specification of Item 41 shall be followed except that the precast tiles shall be of dark shade using ordinary portland cement.

**42.2.0 MODE OF MEASUREMENTS AND PAYMENTS :**

The mode of measurements and payments shall be same as Item No.41  
The rate shall be for a unit of one Sq.metre.

**ITEM NO. 43 :-**

Providing and fixing 20 mm thick pre-cast cement concrete tile with aggregate of sizes upto 6 mm laid in floors, treads, treads of steps and landings on 20 mm thick bed of cement mortar 1:6 (1 Cement : 6 coarse sand) or L.M. 1:1.5 joined with neat cement slurry with pigment to mach the shade of tile complete with precast tiles of dark shades using ordinary cement including rubbing and polishing etc. comp.

**43.1.0 Materials :**

Water shall conform to M-1.Cement shall conform to M-3. Sand shall conform to M-6. Lime mortar 1:1.5 shall confirm to M-10 Cement mortar shall conform to M-10. Tiles shall conform to M- 47 (A).  
Cement concrete tiles shall conform to I.S. 1237-1990 and pigments to be admixed with mortar or for grating shall conform to I.S.2114-1962.

**43.2.0 Workmanship :**

The tiles shall be laid on the sub-grade of concrete of the R.C.C. slab. Bedding shall be lime mortar 1:1.5 or cement mortar ( 1:6 ). The amount of water added shall be minimum required for sufficient plasticity and workability in C.M.or lime mortar where the ingredients shall thoroughly mixed dry, hard lumps removed and water added to give good workability.

The base shall be cleaned of all dust, dirt and scum and properly wetted without allowing water pools, For a bedding of cement mortar he mortar shall be then spread evenly over the base of two rows of tiles and three, to five metres in length. The top shall be kept rough so that cement slurry can be absorbed with the thickness shall be not less then 10 mm at any place. The laying of tiles shall be commenced with neat cement slurry at honey like consistancy and shall be spread over the mortar bed over an area, sufficient to receive about 20 tiles.The tiles shall then be fixed in this grout(one after the other, each tiles being gently tapped and properly bedded in line and level with the adjoining tiles. The joints shall be as narrow as possible and normally shall not exceed 1.5 mm. After the day's work the exess cement slurry on top shall be cleaned as also the joints with a broom stick and washed before the slurry sets hard. Next day the joints shall be filled with the cement grout of the same shade as the matrix of the tiles. Tiles which are fixed in the floor adjoining the wall shall go a minimum of 10 mm, under the wall plaster, skirting or dedo. For the purpose, plaster etc. may be left unfinished by about 50 mm, above the CONSTRUCTION OFfinished level of the floor the unfinished strip shall be plastered laying the floor tiles.Where full tile cement be used,tile shall be cut to the size to be used.

The flooring shall be cured for 7 seven days.

Grinding & rubbing shall normally be commenced after 14 days of laying the tiles, except for skirting small areas, machine shall be used for the purpose.

First grinding shall be done with carborundum stone of 48 to 60 grade grit fitted in machine. Water shall be properly used during grinding. When the chips show up and floor has been uniformly rubbed,it shall be cleaned with water baring all pin holes. It shall then be covered with a thin coat of grey or while cement mixed with or without pigments to match the colour of the topping of the tiles.Pin holes if any shall thus be filled. This grout shall be kept moist for for sufficient period as directed.The after, second grinding shall be started with carborundum of 120 grit Grouting and curing shall be followed again. Final grinding shall be done when other works are finished.The machine shall be fitted with carboundum of grit 220 to 350 using water in abundance.The floor shall then be washed clean with water. Oxalic acid powder shall then be dusted as needed on the surface and the surface rubbed fitted with hessian bobs or rubbed,hard with pad of woolen rags. The floor shall then be washed cleaned and dried with a soft cloth or linen.The finished shall not sound hollow when tapped with a mallet.

If any tile is disturbed or damaged it shall be refitted or replaced jointed and polished.

For skirting,dedo or small areas where it is not possible to do machine polishing all the above operations are to be done manually.

**43.3.0 Mode of measurements and payment :**

The rate shall be include the cost of materials and labour involved in all the operations described above.

The rate shall be for unit of one sq.metre.

**ITEM NO.44 :-**



Providing & laying green polished kota stone slab flooring at all floor levels over 20mm av. th. base of C.M 1:6 Laid over & joined with grey cement slurry incl. rubbing & polished etc. (A)22mm (tolerance+/-2mm)

44.1.0 Materials :-

Water shall conform to M-1.Lime mortar shall conform to M-10 cement mortar shall conform to M-11 polished kota stone shall conform to M-49.

44.2.0 Workmanship :-

44.2.1 Each slab shall be cut to the required size and shape and fine chisel dressed at all the edges. The sides thus dressed shall have a full contact if a straight edge is laid along. The sides shall be table rubbed with on coarse sand before paving. All angles and edges of the slabs shall be true square and free iron chipping and giving a plane surface. The thickness shall be as specified in the item.

44.2.2 Bedding for the kotah stone slabs shall be cement mortar 1:6 [1 cement : 6 coarse sand ] or L.M. 1:1.5 of thickness 20 mm as given in the description of the item. Subgrade shall be cleaned wetted and mopped. Mortar of the specified mix and thickness shall then be spread, on an area sufficient to receive one kotah stone slab. The slab shall be washed clean before laying. It shall be laid on top, pressed, tapped gently to bring it in level with the other slabs. It shall than be lifted and laid aside. Top surface of the mortar shall then be corrected by adding fresh mortar in hollows or depressions. The mortar then be allowed to harden bit. Over this surface, cement slurry of honey like consistency shall be applied. The slab shall then be gently placed in position and topped with wooden mallet till it is properly bedded in level with and close to the adjoining slab. The joint shall be as fine as possible. The slab fixed in the floor adjoining the wall shall enter not less than 10 mm. under the plaster, skirting or dedo. The junction between the wall and floor shall be finished neatly. The finished surface shall be in true levels and slopes as directed.

44.2.3 The floor shall be kept wet for a minimum period of 7 days so that bedding and joints set properly.

44.2.4 Polishing shall be normally commenced after 14 days of laying the stone slab. First polishing shall be done with carborundum stone, of 120 grade grit fitted in the heavy machine and then second polishing shall be done with carborundum stone 220 to 350 grade grit fitted in heavy machine. Water shall properly be used during polishing. The stone shall then be washed clean with water. When directed by the Engineer-in-charge wax polish of approved quality shall be applied on the surface with the help of soft cloth over clean and dry surface then the polishing machine fitted with beds shall be run over it.

44.2.5 The holes required for Nahni traps, pipes and any other fitting shall be made without extra cost.

44.3.0 Mode of Measurements & payments:-

The rate shall include the cost of all materials and labour involved in all the operations described above. The kotah stone flooring shall be measured in square metres correct to two places of decimal, length and breadth shall be measured correct to a centimeters and between the finished face of skirting dedo or mall plaster and no deduction shall be made nor extra paid for opening in floor of areas upto 0.1 Sq.Mt. The rate shall be for a unit of one sq.metre.

**ITEM No.45 :-**

Providing and laying polished kota stone of machine cut edge slab 22mmth.in riser of steps or treads, dedo and pillars, centre piece not less than 1.2 mt. in width and side as per design, laid on 10 mm. thick cement mortar 1:3 (1cement : 3 coarse sand ) joined and polished etc. complete.

45.1.0 Materials :

Water shall conform to M-1. Cement mortar shall conform to M-11. Kotah stone slab shall conform to M-49.

45.2.0 Workmanship :

The relevant specifications of Item No. 44 shall be followed except that the kotah stone shall be fixed for risers steps, dedo or skirting in C. M 1:5 and the polishing shall be done manually instead of machine polishing, the exposed edge of kotah stone shall be machine cut.

45.3.0 Mode of measurements and payment :

The risers of steps,skirting or dedo shall be measured in sq. metre. Length shall be measured along the finished faces of risers,skirting or dedo.Height shall be measured from finished level of treads of floor to top. Lining of pillars shall be measured under this item.

The rate shall be for a unit of one sq.metre.

**ITEM No. 46 :-**

Providing & Laying white glazed tiles 6mm. th. of Orient, Kajaria, Jhonson,Nitco,Somani ,Bell make at all floor levels, in flooring, treads of steps & landings laid on a bed of 20 mm. Av. Th.C.M.1:3(1cement :3 sand) finished with flush pointing in white cement etc.com. For all floors (Basic Rate:- Rs.285.0/S.M.)

46.1.0 MATERIALS

Water shall conform to M-1. Cement mortar shall conform to M-11. White glazed tiles shall conform to M-35.

46.2.0 WORKMANSHIP

46.2.1 Bedding - The sub-grade shall be cleaned, wetted and mopped. The bedding shall then be laid evenly over the surface tamped and corrected to desired levels and allowed to harden enough to offer a rigid cushion to tiles and to enable the mason to place wooden planks across and squat on it. The white glazed tiles shall be





laid on cement mortar bedding of 12mm. thick in C.M. 1:3. The mortar shall have sufficient plasticity for laying and there shall be no hard lumps that would interfere with the evenness of bedding. The base shall be cleared and well wetted. The mortar shall then be spread in thickness not less than 10mm. at any place and on an average 12mm. thickness. The proportion of the cement mortar shall be as specified in the item.

Fixing Tiles - The tiles before laying shall be soaked in water for at least two hours. Neat grey cement grout at 3.3 Kgs./Cement/Sq.Mts. of honey like consistency shall be spread over the mortar bedding as directed. The edges of the tiles shall be well pressed and gently tapped with a wooden mallet till they are properly bedded and in level with the adjoining tiles. There shall be no hollows in bed or joints. The joints between the tiles shall be as thin as possible in straight line or as per pattern.

The tiles shall not have staggered joints. The joints shall be thereto centre line both ways. The nahn trap coming in the flooring shall be so positioned that its grating shall replace only one tile as far as possible. Where full size tiles cannot be fixed, they shall be cut (swan) to the required size and the edge rubbed smooth to ensure straight and true joints. The joints shall be filled with grey cement grout with wire, brush or trowel to a depth of 5mm. and loose material removed. White cement shall be used for pointing the joints. After fixing the tiles finally in an even plane the flooring shall be kept wet and allowed to stay undisturbed for 7 days.

Cleaning - The surplus cement grout that may have come out of the joints shall be cleared off before it sets. Once the floor has set, it shall be carefully washed, cleared by dilute acid and dried. Proper precautions and measures shall be taken to ensure that the tiles are not damaged in any way till the completion of the construction.

46.3.0 **MODE OF MEASUREMENTS & PAYMENTS**

46.3.1 The work done shall be measured in Sq.Mts. for visible area of work done. The length and width of the flooring shall be measured between the faces of skirtings or dados or plastered face of wall as the case may be. The paving under dedo or skirting shall not be measured. No deductions shall be made for extra paid for any opening in the floor of area upto 0.1 Sq.Mts. Nothing extra shall be paid for laying the floors at different levels in the same rooms.

46.3.2 The rate shall be for a unit of one Sq.Mts.

**ITEM NO.46(A) :**

Providing and laying ceramic vitrified flooring tiles of Orient, Kajaria Jhonson, Nitco, Somani, Bell, Asian or Euro make in flooring treads of steps and landing laid on bed of 12 mm thick cement mortar 1 : 3 (1 cement : 3 Coarse sand) finished with flush pointing in white cement (Basic rate Rs 330.0 / SM. )

Details specification as per Item No.46 read ceramic tiles instead of glazed tiles.

The rate shall be for a unit of one Sq.Mts.

**ITEM NO.46(B) :**

Providing & Laying Commercial Quality white glazed tiles 6mm. th. in flooring laid on a bed of 20 mm. Av. Th.C.M.1:3(1cement :3 sand ) & on wall Of R.C.C. Tank with necessary cement paste for fixing and joined with white cement slurry etc. complete. finished with flush pointing in white cement etc.com.

Details specification as per Item No.46 read ceramic tiles instead of glazed tiles.

The rate shall be for a unit of one Sq.Mts.

**Item No. 47 :-**

Providing & Laying white glazed tiles 6mm. th. Of Orient, Kajaria, Jhonson, Nitco, Somani, Bell make at all floor levels in skirting risers of steps & dado on 10 mm. th. C.M.1:3(1cement :3 sand) including necessary cement paste for fixing and joined with white cement slurry etc. complete. For all floors (Basic Rate:- Rs.285.0/S.M.)

47.1.0 **MATERIALS**

Water shall conform to M-1. Cement mortar shall conform to M-11. White glazed tiles shall conform to M-55.

47.2.0 **WORKMANSHIP**

47.2.1 Preparation of Surface - In case of brick masonry work, the joints shall be raked out to a depth of at least 15 mm. the surface shall be chiselled and roughened with wire brushes. The surface shall be cleaned and wetted thoroughly before commencing the laying work.

Laying - The wall surface shall be covered with 10mm. thick plaster of cement mortar 1:3 mix and allowed to harden. The plaster shall be roughened with wire brushes both ways. The back of tiles shall be floated with grey cement slurry and edges with white cement slurry set in bedding mortar. The tiles shall be gently tapped in position one after the other keeping the joints as thin as possible. Dedo shall be truly horizontal and the joints vertical or as per the required pattern.

Risers of steps, skirting and dedo shall rest on top of treads or flooring. Where full size tiles cannot be fixed, they shall be cut to the required size and the edges to be smoothed.

The joints shall be cleaned and flush pointed with white cement. The surface shall be kept wet for seven days. After curing the surface shall be washed clean.

**47.3.0 MODE OF MEASUREMENTS & PAYMENTS**

47.3.1 The rate shall include the cost of all materials and labour required for various operations described above. Risers of steps, skirting and dedo shall be measured in Sq.Mts. Length and height shall be measured along the finished face of the skirting or dedo including curves, where special such as covers, internal and external angles etc. used. The length and height shall be measured correct to the cms. except in case of risers and skirting where height shall be measured correct to 3mm.

47.3.2 The rate shall be for a unit of one Sq.Mts.

**Item No. 47A :-**

Providing and laying Vitrified tiles of 8mm to 10mm thick of Orient, Kajaria, Jhonson, Nitco, Somani, Bell, Asian or Euro make in skirting, risers of steps and dedo laid on 10mm thick cement mortar 1:4 (1 Cement : 4 Coarse sand) and finished with flush pointing in white or colour cement comp. Size 24" x 24"(Basic Rate: Rs.412.0/S.M.)

Details specification as per Item No.46 read ceramic tiles instead of glazed tiles.

The rate shall be for a unit of one Sq.Mts.

**ITEM NO.48 :**

Providing and laying cement concrete work 1:1.5:3 [1 Cement, 1.5 coarse sand:3 graded stone aggregates 20 mm nominal size) and curing complete excluding cost of form work and reinforcement for reinforced concrete work in (A) Staircase (B)Vertical and horizontal fins etc. comp. for above floor two level.

**48.1.0 MATERIALS AND WORKMANSHIP :**

The relevant specification of Item No. 3 shall be followed except that the concrete work shall be carried out for super structure above floor two level.

**48.2.0 MODE OF MEASUREMENT & PAYMENT :**

The relevant specifications of Item No.3 shall be followed.

The extra payment shall be made for additional lift above floor two level to each additional floor over and above. The rate of concrete work shall be measured and paid under this item.

The rate shall be for a unit of one cubic metre.

**Item No. 48A :-**

Providing & laying 100% vetrified tile 8mm thick anti-skidd (MAT) of Orient, Kajaria, Jhonson, Nitco, Somani, Bell, Asian or Euro make in flooring,treads of steps & Landing laid on bed of 20 mm (Average) base of cement mortar 1:6 (1 Cement : 6 Coarse sand) on new surface or fixing on existing flooring by adhesive material including dismantling of existing flooring and jointed with colour cement slurry including finished with flush pointing & cleaning the surface etc. comp.Size 800 x 800 (Basic Rate-.538.00/S.M.)

Details specification as per Item No.46 read ceramic tiles instead of glazed tiles.

The rate shall be for a unit of one Sq.Mts.

**Item No. 48B :-**

Providing & laying Vitrified tiles of 8mm thick of Orient, Kajaria, Jhonson, Nitco, Somani, Bell, Asian or Euro make in flooring,treads of steps & Landing laid on bed of 20 mm (Average) base of cement mortar 1:6 (1 Cement : 6 Coarse sand) on new surface or fixing on existing flooring by adhesive material including dismantling of existing flooring and jointed with colour cement slurry including finished with flush pointing & cleaning the surface etc. comp.Size 24" x 24" (a) Light Shade (Basic Rate-Rs.412.0/S.M.)

Details specification as per Item No.46 read ceramic tiles instead of glazed tiles.

The rate shall be for a unit of one Sq.Mts.

**ITEM NO.49 :**

Providing and laying ordinary cement concrete 1:1.5:3 [1 Cement, 1.5 coarse sand:3 graded stone aggregates 20 mm nominal size) and finishing smooth with cement plaster in cement mortar 1:3 and curing etc. complete including the cost of form work but excluding the cost of reinforcement for R.C.C. work in (A) Columns (I) Having cross sectional area 0.05 to 0.08 Sq.mt. (II) Having cross sectional area more than 0.08 Sq.mt. and upto 0.12 Sq.mt. (III) Having cross sectional area more than 0.12 Sq.mt. and upto 0.18 Sq.mt. (B) Beams (I) Having cross sectional area 0.05 to 0.08 Sq.mt. (II) Having cross sectional area more than 0.08 Sq.mt. upto 0.12 Sq.mt. (III) Having cross sectional area more than 0.12 Sq.mt. upto 0.18 Sq.mt. (C) Slabs : (I) Slabs upto 8 cms thickness (II) Slabs having more than 8 cms and upto 10 cms thickness (III) Slabs having more than 10 cms and upto 13 cms thickness (IV) Slabs having thickness more than 13 cms and upto 15 cms thickness (D) Lintels etc. complete for above floor two level.

**49.1.0 MATERIALS AND WORKMANSHIP :**

The relevant specification of Item No.5 shall be followed except that the concrete work shall be carried out for super structure above floor two level.

**49.2.0 MODE OF MEASUREMENT AND PAYMENT :**

The relevant specification of Item No.5 shall be followed.

The extra payment shall be made for additional lift above floor two level to each additional floor over and above the rate of concrete work shall be measured and paid under this item.

The rate shall be for a unit of one cubic metre.

**ITEM NO.50 :**

Providing and laying cement concrete 1:1.5:3 [1 Cement, 1.5 coarse sand:3 graded stone aggregate 20 mm nominal size) for reinforced concrete chhajras not exceeding 10 cms thickness above floor two level including finishing the exposed surfaces with cement mortar 1:3 (1 Cement : 3 fine sand) to give a smooth and even surface centering and form work and curing complete excluding cost of reinforcement etc. complete.

## 50.1.0 MATERIALS AND WORKMANSHIP :

The relevant specification of Item No.6 shall be followed except that the concrete work shall be carried out for super structure above floor two level.

## 50.2.0 MODE OF MEASUREMENT &amp; PAYMENT :

The relevant specifications of Item No.6 shall be followed.

The extra payment shall be made for additional lift above floor two level to each additional floor over and above. The rate of concrete work shall be measured and paid under this item.

The rate shall be for a unit of one cubic metre.

**ITEM NO.51 :**

Providing TMT/CRS bars steel reinforcement for R.C.C. work including bending binding and placing in position complete above floor twl level etc. complete.

## 51.1.0 MATERIALS AND WORKMANSHIP :

The relevant specification of Item No.7 shall be followed except that the work shall be carried out for super structure above floor two level.

## 51.2.0 MODE OF MEASUREMENT &amp; PAYMENT :

The relevant specifications of Item No.7 shall be followed.

The extra payment shall be made for additional lift above floor two level to each additional floor over and above the work shall be measured and paid under this item.

The rate shall be for a unit of one Kg. per floor.

**ITEM No.52 :-**

Providing cement vata (10 cms x 10 cms) size quarter round in cement mortar 1:1 including neat cement finishing watering etc.comp.

## 52.1.0 Material :

Water shall conform to M-1 cement mortar shall conform to M-11.

## 52.2.0 Workmanship :

The work of cement vata of 10 cms x 10 cms size shall be carried out at junctions of parapets and terraces as directed. The vata shall be finished in quarter round shape. The work shall be carried out in the best workmanlike manner. The inlet portion of rain water pipe shall be rounded off properly during constructing the vata. The work shall be cured for 7 days.

## 52.3.0 Mode of measurements and payment :

The work shall be measured for finished item in running metre. The rate shall be for a unit of one running metre.

**ITEM No.53A :-**

Prov.& Fixing water closet squatting pan (Orissa type W.C.pan) at all floor levels, size 580mm incl. 100 mm size "P" or "S" trap for water closet squatting pan joining the trap with the pan & soil pipe in C.M. 1:1 (1cement :1 fine sand) etc. Comp (A) Vitreous china long pattern of approved colour and make of Parshuram, Cera, Hind, Johnson or equivalent make as directed by engg in charge.

## 53.1.0 Materials

Water closet squatting pan (Orissa type W.C. Pan) and `P' Trap shall conform to M-62, foot rests shall conform to M- 62A. Cement mortar shall conform to M-11.

## 53.2.0 WORKMANSHIP

53.2.1 The pan shall be sunk into the floor and embedded in a cushion of average 15 cms. cement concrete 1:5:10 (1 cement; 5 fine sand; 10 graded stone aggregate or brick aggregate 40 mm. nominal size) or as specified. This concrete shall be left 115 mm. below the top level of the pan so as to allow for flooring and its bed concrete. The floor should be suitably sloped so that the waste water is drained into the pan. The pan shall be provided with 100 mm. `P' or `S' trap as specified in the item with approximately 50 mm. seal. The joints between the pan and the trap shall be made leak- proof with cement mortar 1:1 (1 cement; 1 fine sand).

53.2.2 The `P' or `S' trap shall be fixed with pan and cast iron pipe with C.M. 1:1. The pan shall be provided with a 100 mm. `P' or `S' trap as specified in the item with an approximately 50 mm. seal. The joint between the pan and the trap shall be made leakproof with cement mortar 1:1 (1 cement; 1 fine sand).

53.2.3 After laying the floor, the floor shall be suitably sloped so that the waste water is drained into the pan. A pair of foot-rests of size 250 mm x 130 mm x 30 mm of white vitreous china shall be set in cement mortar 1:3 (1 cement; 3 coarse sand). The foot rests shall be fixed at a distance of 175 mm. from the inner edge of the back side of the pan and shall be fixed at convenient angle.

## 53.3.0 MODE OF MEASUREMENT &amp; PAYMENT :

53.3.1 The rate shall include the cost of all materials and labours involved in all the operations described under workmanship.

53.3.2 The rate shall be for a unit of one number.

**ITEM NO.53B:**

Providing and fixing Wash Down Water closet European type W.C. pan with integral P or S trap including jointing the trap with soil pipe in cement mortar 1:1 (1 cement : 1 fine sand) (seat and cover to be measured and paid for separately) (A) Vitreous china pattern - I (i) in approved colour

Details specification as per Item Description and M-No.53 and as directed by Engineer-in-charge.  
The rate shall be for a unit of one number.

**ITEM NO.53C:**

Providing and fixing plastic seat and cover for wash down water closet with C.P. brass hinges and rubber buffers (B) Black plastic seat and cover.

Details specification as per Item Description, M-60 and as directed by Engineer-in-charge.

The rate shall be for a unit of one number.

**ITEM No.54 :-**

Providing and fixing wash basin with single hole for pillar tap at all floor levels, with C.I. or M.S. Brackets painted white incl. cutting holes & making good the same incl. fittings such as pillar tap, capstan head screw down high pressure with screws, shanks & back nuts, C.P. Brass waste trap, screw down stop tap 15 mm. dia. etc. complete. (A) Vitreous china flat back wash basin 550 mm. x 400 mm. size in approved colour for all floor

**54.1.0 MATERIALS**

54.1.1 The white glazed earthenware wash basin shall be 550 mm. x 400 mm. of 1st quality and make as approved by the Engineer-in-charge. The wash basin shall conform to M-59. The capstan head pillar tap of specified dia. of C.P. over brass shall be of best quality and shall conform to I.S. 1975-1961. The pillar taps shall be of tested quality. The C.P. brass trap and union shall be of 32 mm.dia. and of best quality and make as approved by the Engineer-in-charge. The brass screw down stop cock of specified dia. shall conform to I.S. 781-1977. The stop cock shall be of tested quality.

**54.2.0 WORKMANSHIP**

54.2.1 The wash basin shall be fixed on the wall as and where directed. The wash basin shall be supported on a pair of M.S. or C.I. brackets fixed in C.M. 1:3 (1 cement; 3 sand). The bracket shall conform to I.S. 775-1962. The wall plaster on the rear shall be cut to rest the top edge of the wash basin. After fixing the basin, plaster shall be made good and surface finished to match with the existing one.

54.2.2 The bracket shall be painted white with ready mixed paint. The C.P. brass trap and union shall be connected to 32 mm.dia. waste pipe which shall be suitably bent towards the wall and which shall discharge into an open drain leading to a gully trap or direct into the gully trap on the ground floor and shall be connected to a waste pipe through a floor trap on the upper floors. C.P. brass trap and union may not be provided where the surface drain or a floor trap is placed directly under the basin and the waste is discharged into vertically.

54.2.3 The height of the front edge of the wash basin from the floor level shall be 80 cms.

54.2.4 The capstan head pillar tap of specified dia. shall be fixed as directed with required washers of selected leather or rubber asbestos composition or plastic as directed. The cock shall be fixed with pipe line with white zinc and spun yarn, to make joint water tight. The work shall be carried out in best workman like manner.

54.2.5 C.P. brass waste trap and union shall be connected to 32 mm.dia. waste pipe which shall be connected suitably towards the wall and which shall discharge into the drain through a floor trap. The C.P. brass waste trap shall be provided for wash basin or sink as the case may be.

54.2.6 The stop cock shall be fixed in position by means of jam, nut & socket. The stop cock shall be fixed near the inlet of the water metre or as directed. The joints shall be done with white zinc and spun yarn. The joint shall be tested for leak proofing.

54.2.7 The necessary inlet, outlet connections and fittings such as pillar cocks, C.P. brass waste trap, waste pipe, stop cock etc. shall be fixed as specified above.

54.2.8 The payment of fittings shall be made under this item.

**54.3.0 MODE OF MEASUREMENTS & PAYMENTS**

54.3.1 The rate includes cost of all labour, materials, tools and plant etc. required for satisfactory completion of this item as specified in workmanship.

54.3.2 The rate shall be for a unit of one number.

**ITEM NO.55 :**



Providing & fixing 600 mm.x 450 mm. mirror of superior glass at all floor levels, mounted on 6 mm. th. A.C. sheet or plywood sheet & fixed to wooden plugs with C.P.brass screws and washers etc. For all Floor

55.1.0 MATERIALS :

The 600 mm x 450 mm size mirror shall be of superior glass with edge rounded off or bevelled as specified. It shall be free from flaws specks, or bubbles and its thickness shall not be less than 6 mm. The glass for the mirror shall be uniformly silver plated at the back and shall be free from silvering defects, silvering shall have a protective uniform covering of red lead paint. The 6 mm. thick plywood shall conform to M-37. The 6 mm. thick A.C. Sheets shall conform to M-24.

55.2.0 WORKMANSHIP :

The mirror of 500 mm x 450 mm size mounted on A. C. Sheet or plywood 6 mm thick with C.P. brass clips shall be fixed as directed by fixing wooden plugs in wall and C.P. brass screws and washers, The work shall be carried out in best workman like manner.

55.3.0 MODE OF MEASUREMENT AND PAYMENT :

The rate includes cost of labour and materials tools and plant etc. required for satisfactory completion of this item. The rate shall be for a unit of one number.

**ITEM No. 56 :**

Providing & Fixing PVC Nanhi trap 31/2" ht.of Prince/ Supreme/ Jain/ Astral/ Tulsi/Finolex make at all floor levels of self cleaning design with screwed down or hinged grating incl. cost of cutting making good the walls & floors etc. For all Floor

56.1.0 MATERIALS

56.1.1 The UPVC nahni trap shall conform to M-68-A.

56.2.0 WORKMANSHIP

56.2.1 The nahni trap with 100 mm.dia. inlet and 50 mm.dia. outlet shall be fixed as per drawings or as directed.

56.2.2 The nahni trap shall be jointed with PVC pipe, 75 mm.dia. with jointing materials as per manufacturer's instruction.

56.3.0 MODE OF MEASUREMENTS & PAYMENTS

56.3.1 The rate includes cost of all labour, materials, tools and plants etc. required for satisfactory completion of this item including lead jointing and testing.

56.3.2 The rate shall be for a unit of one number.

**ITEM No. 56A :**

Providing & Fixing cast iron(spun) Nanhi trap at all floor levels of the following nominal diameter of self cleaning design with C.I. screwed down or hinged grating incl. cost of cutting making good the walls & floors 100 mm. Inlet&50 mm outlet etc. For all Floor

Details specification same as per Item No.56 but read Cast Iron Spun) Nanhi trap instead of U-PVC Nanhi trap and as directed by Engineer-in-charge.

**ITEM NO. 57 :**

Prov. & Fixing S.W. Gully trap with C.I.grating brick masonry (C.M 1:5)chamber & water tight Pre cast R.C.C. cover of 300mmx300mm size (inside) includ. plastering smooth inside & outside 15mm. th' in C.M.1:3 etc. comp. (i) Square mouth traps--(A) 100mm x 300mm Size -P type

57.1.0 MATERIALS :

(1) Water shall conform to M-1. (2) Cement mortar of proportion 1:5 shall conform to M-11. (3) Flyash Building brick shall conform to M- 15(A). (4) The S. W. Gulley trap of 100 mm x 100 mm size shall conform to M-70.

57.2.0 WORKMANSHIP :

Excavation for gulley trap shall be done true to dimensions and levels as indicated on plans or as directed. The excavation work shall generally be done as per relevant specification of item 1(a) or earth work.

Fixing :

The gulley trap shall be fixed over cement concrete 1:5:10 (1 Cement : 5 sand : 10 graded brick bats aggregate 40 mm nominal size) foundation 650 mm square and 100 mm thick. The depth of top of concrete below the ground level shall be 675 mm. The jointing of gulley outlet to the branch drain described in Item No.60.

Brick Masonary Chamber :

After fixing and testing gulley and branch drain, a brick masonry chamber 300 mm x 300 mm inside with bricks in C.M. 1:5 (1 Cement : 5 sand) shall be built with a 100 mm brick work round the gulley trap from the top of bed concrete upto ground level. The space between the chamber walls and trap shall be filled with cement concrete 1:5:10. The upper portion of the chamber i.e. above the top level of the trap shall be plastered inside with cement mortar 1:3 (1 Cement : 3 sand) finished with floating coat of neat cement. The corners and bottom of the chamber shall be rounded of so as to slope towards.

C.I. Cover with frame 300 mm x 300 mm (Inside) size shall then be fixed on the top of the brick masonry with C.C. 1:2:4(1 Cement : 2 coarse sand : 4 graded stone aggregate 20 mm nominal size) 40 mm thick and





rendered smooth. The finished top of the cover shall be left about 40 mm above the adjoining ground level so as to exclude the surface water from entering the gully trap.

57.3.0 MODE OF MEASUREMENTS AND PAYMENT :

The rate includes cost of all labour, materials tools and plant etc. required for satisfactory completion of this item as described above.

**ITEM No 58 :**

Prov. & Fix. 10 cm.x15 cm.(4" x 6") S.W. trap with Inside dimension ,455 x 610 mm & 450 mm deep sewer trap chamber with 23 cm th' B.B. masonry walls in C.M 1:5 with cement plaster 15 mm th' in C.M. 1:3 inside & outside to exposed faces, R.C.C. top slab with 1:2:4 mix ( 1 cement: 2 Sand : 4 Grade stone aggregate 20mm size) ,Foundation concrete 1:5:10 & fixing C.I. cover with frame to be not less than 38 kg. On top etc. comp. for single pipe.

**(A) same as above but precast RCC heavy duty cover instead of C.I. Cover.**

General :-

The item refers to provide and fix 10 cms. x 15cms. S.W.trap with 0.45 x 0.60 mts. clear opening sewer trap chamber with 23 cms. thick B.B. masonry walls in C.M. 1:5 with cement plaster inside and outside to exposed faces including fixing C.I. cover of 38 Kgs. on top sewer trap.

58.1.0 MATERIALS

The stone wall sewer trap shall be of 10cms. x 15cms. size conforming to relevant I.S. 651-1980.

58.2.0 WORKMANSHIP

58.2.1 Necessary excavation shall be done as required. The foundation cement concrete of 1:5:10 shall be laid for a thickness of 15cms. The S.W. trap shall be fixed into the position on the main sewer side of the chamber as directed. Brick masonry chamber of one brick thickness in C.M. 1:8 shall be constructed with the inside dimensions 60cms. x 45cms.

58.2.2 The inside of the chamber shall be plastered in 15mm. thick C.M. 1:3 and shall be finished smooth with cement slurry. The outside of the chamber shall be plastered to a depth of 30 cms. from the top of the chamber. The item also includes providing and laying 1:2:4 cement concrete for fixing the C.I. frame and cover. The C.I. frame and cover shall be of the specified size and it shall not weigh less than 38 Kgs. including frame and cover and shall be painted with two coats of anti-corrosive paint of approved make.

58.3.0 MODE OF MEASUREMENTS & PAYMENTS

58.3.1 The rate includes costs of all materials, labour, tools, plants, etc. required for carrying out satisfactory completion of items as described above.

58.3.2 Rate shall be as per number basis.

**ITEM NO. 59 :**

Providing & construction simple chamber of 23 cm. th' B.B. Masonary in C.M 1:5 with cement plaster 15 mm th' in C.M. 1:3 inside & outside to exposed faces, R.C.C. top slab with 1:2:4 mix ( 1 cement: 2 Sand : 4 Grade stone aggregate 20mm size) ,Foundation concrete 1:5:10 & fixing C.I. cover with frame to be not less than 38 kg. On top etc. comp. Inside dimension,455 x 610 mm &450 mm deep for single pipe

59.1.0 Materials :

Water shall confirm M-1. Cement shall confirm to M-3. Coarse sand shall confirm to M-6. Flyash Building Brick shall confirm to M-15(A). Cement mortar shall confirm to M-11.

59.2.0 Workmanship :-

59.2.1 The item covers the construction of simple chamber of clear size 0.45 x 0.60 mts.with 23 thick brick wall in C.M.1:5 and smooth plaster 15 mm thick C.M. 1:3 Bedding concrete of C.C. 1:5:10, 150 mm thick, the projected bed concrete beyond chamber wall shall be of 75 mm. The chamber frame & cover shall be of C.I. as weight not less than 38 Kg. fixed with C.M. 1:1 etc. comp.

59.2.2 Specification for item No.1[a] shall be read for excavation, & specification for Item No.8 shall be adopted for P.C.C. and specification for Item No.12 shall be read for B.B. Masonary and specification for Item No.14 shall be read for plaster work except that the thickness of plaster shall be 15 mm thick in CM 1:3.

59.3.0 Mode of Measurements and payments :-

[1] The rates including all labours, materials, tools and plats etc. required for satisfactory completion of this work.

[2] The rate shall be for a unit of one number.

**ITEM No.60 :-**

Providing, Lowering & laying joining R.C.C. NP2 CLASS Pipe In C.M. 1:1 of following nominal internal diameters incl. Testing of pipes and joints etc. Comp (A) 100 mm. dia. (B) 150 mm dia.

60.1.0 MATERIALS :

60.1.1 The reinforced concrete light duty non-pressure pipes of specified diameter shall confirm to I. S. 458-1971. Cement mortar of required proportion shall conform to M-7.

60.2.0 WORKMANSHIP :

60.2.1 EXCAVATION OF TRENCHES:



60.2.1.1 The width of the trenches shall be 1.05/1.20 metre and depth shall be corresponding to invert level of the screen chamber and required levels as directed.

60.2.1.2 At joints, the trench width shall be widened where necessary. The work of excavation and refilling shall be done true to line and gradient in accordance with general specifications of earth work in trenches.

**60.2.2 LAYING:**

60.2.2.1 The pipe shall be laid accurately and perfectly true to line, levels and gradients. Great care shall be taken to prevent sand etc. from entering the pipes. The pipes between two manholes shall be laid truly in a straight line without vertical or horizontal undulation. All junctions and changes in direction and diameter shall be made inside manholes by means of curved tapered channels formed in cement concrete finished smooth and benched on both sides. The body of the pipe shall rest for its entire length, on an even level bed grips being made of left on the bed to receive the sockets of the pipes.

**60.2.3 JOINTING :**

60.2.3.1 Tared gasking or yarn soaked in neat cement slurry shall first be placed around the spigot of each pipe and spigot shall then be placed well home into the socket of the pipe previously laid.

The pipe shall then be adjusted and fixed in the correct position and gaskin caulked home so as to fill not more than 1/4th of the total depth of (13 mm in depth) the socket.

60.2.3.2 The remainder of the socket shall be filled with stiff mixture of cement mortar in proportion of one part of cement and one part of sharp sand. When the a socket is filled, a fillet shall be formed round the joints forming an angle of 45 degree with the barrle of the pipe.

60.2.3.3 The mortar shall be mixed as necessary for immediate use.

60.2.3.4 After the joint is made, any extraneous materials shall be removed from the inside of the joints with a suitable scraper or 'badger'. The newly made joints shall be protected, until set, from the sun, dry winds, rain or frost, sacking or other suitable materials which shall be used for the purpose.

60.2.3.5 The mortar shall be cured for 10 days.

**60.3.0 MODE OF MEASUREMENT AND PAYMENT :**

60.3.1 Pounding or bottaning of the trenches bed to fit the lower part of the pipe and 'Grips' dug to take socket collars etc. are included in the rate of laying the pipes.

60.3.2 The measurements shall be net without any allowance for cutting and waste. The length of bends, junctions and other connection shall be included in the total length of the pipe drains. Nothing extra shall be paid for the same. The rate excludes necessary excavation, including refilling trenches etc.complete.

60.3.3 The rate shall be for a unit of one running metre.

**ITEM No 61 :-**

Providing & Fixing to wall, ceiling floor at all floor levels, galvanised mild steel tubes (medium grade) TATA / ZENITH / ASIAN / JINDAL MAKE of the following nominal bore, tube, fittings & clamps incl. making good the wall ceiling and floor etc. complete. (a) 25 mm. dia. (b) 15 mm. (c) 40 mm dia.

**61.1.0 MATERIALS**

Galvanised mild steel tubes of specified dia. nominal bore shall conform to I.S. 1239-1990. The galvanised fittings, clamps, etc. required for specified dia. bore pipes shall be of best quality and make as approved by the Engineer-in-charge. (Galvanised iron pipes and fittings shall conform to M-56)

**62.2.0 WORKMANSHIP**

62.2.1 Cutting, Laying & Jointing - When the tubes are to be cut or rethreaded, the ends shall be carefully filed out so that no obstruction to bore is offered. The ends of the tubes shall then be threaded conforming to the requirements of I.S. 554- 1955 with pipe dies and taps carefully in such a manner as will not result in slackness of joints when the two pieces are screwed together.

The taps and dies shall be used only for straightening screw threads which have become bent or damaged and shall not be used for turning of the threads so as to make them slack as the latter procedure may not result in a water tight joint. The screw threads for the tube and fittings shall be protected from edge until they are fitted.

In jointing the tubes, the inside of the socket screwed end of the tubes shall be oiled and smeared with white or red lead and wrapping around with a few turns of fine spun yarn round the screwed end of the tube. The end shall then be tightly screwed in the socket, tees, etc. with a pipe wrench. Care shall be taken that all pipes and fittings are properly jointed so as to make the joints completely water tight and pipes are kept at all times free from dust and dirt during fixing. Burr from the joints shall be removed after screwing. After laying the open ends of the pipes shall be temporarily plugged to prevent access of water, soil or any other foreign matter.

Any threads exposed after 3 jointing shall be painted or in the case of underground piping thickly coated with approved anti-corrosive paint to prevent corrosion.

61.2.2 Laying in Trenches - The width and depth of the trenches for different diameters of the tubes shall be as - For 15 to 80 mm. dia. tube width of trenches shall be 30 cms. and depth of trenches 60 cms.



At joints, the trench width shall be widened where necessary. The work of excavation and refilling shall be done true to line and gradient in accordance with general specifications of earth work in trenches.

The pipes shall be painted with two coats of anti-corrosive bitumastic paint of approved quality. The pipe shall be laid on a layer of 75mm. sand filled upto 150mm. above the pipe if so specified. The remaining portion of trench shall be then filled with excavated earth. The surplus earth shall be disposed of as directed. When the excavation is done in rock the bottom shall cut deep enough to permit the pipe to be laid and cushion of sand 75 mm. In case of bigger diameter of tube where pressure is very high, thrust block of cement concrete 1:2:4 (1 cement; 2 coarse sand; 4 graded stone aggregate of 20 mm. nominal size) shall be constructed on all bends to transmit the hydraulic thrust without imparing the ground and spreading it over a sufficient area if so specified.

- 61.2.3 Fixing of Tube Fittings to wall ceiling & floors - In case of fixing of tubes and fittings to the walls or ceilings, these shall run on the surface of the wall or ceiling (not in chase) unless otherwise specified. The fixing shall be done by means of standard pattern, holder clamps keeping the pipes about 15mm. clear of the wall. When it is found necessary to conceal the pipes and when specified so, chasing may be adopted or pipe fixed in ducts or recesses etc. provided that there is sufficient space to work on the pipe with usual tools. The pipe shall not ordinarily be buried in walls or solid floors, where unavoidable pipes may be buried for short distances provided that adequate protection is given against damage and where so required joints are not buried. Where required M.S. tube sleeves shall be fixed at a place a pipe is passing through a wall or floor for expansion and contraction and other movements. In case the pipe is embeded in walls or floors, it should be painted with anti-corrosive bitumastic paint of approved quality. The pipe should not come in contact with lime mortar or lime concrete as the pipe is affected by lime, under the floors, the pipe shall be laid in layer of sand filling.

All pipes and fittings shall be fixed truly vertical and horizontal unless unavoidable. The pipes shall be fixed to walls with standard pattern clamps or required size and shape, one end of which shall be properly plugged or cemented into walls with cement mortar 1:3 (1 cement; 3 coarse sand) and the other tightened round the pipes to hold it securely. These clamps shall be spaced at regular intervals in straight lengths at 2 M c/c interval in horizontal run and 2.5 M. intervals in vertical run. For pipe of 15 mm. dia. upto 25 mm. dia. the holes in the walls and floors shall be made by drilling with chisel or jumper and not by dismantling the brick or concrete. However, for bigger diameter pipes the holes shall be carefully made of the smallest required size. After fixing the pipe holes shall be made good with cement mortar 1:3 (1 cement; 3 coarse sand) and properly finished to match the adjacent surface.

- 61.2.4 Testing of Joints - After laying and jointing, the pipes and fittings shall be inspected under working conditions of pressure and flow. Any joint found leaking shall be redone, and all leaking pipes removed and replaced without extra cost.

The pipes and fittings after they are laid shall be tested to hydraulic pressure of 6 Kg./sq.cm. The pipe shall be slowly and carefully charged with water allowing all air to escape and avoiding all stock and water hammer. The draw off takes and stock shall then be closed and specified hydraulic pressure shall be applied gradually. The pressure gauge must be accurate. The pipes and fittings shall be tested in sections as the work of laying proceeds, veeping the joints exposed for inspection during the testing.

- 61.3.0 MODE OF MEASUREMENTS & PAYMENTS

- 61.3.1 The description of each item, shall unless otherwise stated, be held to include where necessary, conveyances and delivery, handling, unloading, storing, fabrication hoisting, all labour for finishing to required shape and size setting fitting in position, straight, cutting and waste, return of packing etc.

- 61.3.2 The length shall be measured on running metre basis of finished work. The length shall be taken along the centre line of the pipe and fittings. The pipes fixed to walls, ceiling, floors etc. shall be measured and paid under this item.

- 61.3.3 All the work shall be measured in decimal system as fixed in its place, subject to tolerance given below unless otherwise stated.

[ i] Dimension shall be measured to the nearest 0.01 metre.

[ii] Area shall be worked out to the nesrest 0.01 Sq.mt.

- 61.3.4 In case of fittings of unequal bore, the largest bore shall be measured for the test.

- 61.3.5 Testing of pipe lines, fittings and joints included for providing all plant and appliances necessary for obtaining access to the work to be tested and carrying out the tests.

- 61.3.6 The rate includes galvanised steel tubing with screwed socket joints, together with all fittings (such as bends, sockets, springs, elbows, tees, crosses, short pieces, clamps and plug unions etc.) and fixing complete with clamping wall-hooks, wooden plugs etc. and also cutting screwing and waste and for making forged (or hand made) bends on piping as required. The rate also includes cutting through walls, floors etc. and their making good and painting exposed threads with anti-corrosive paint as above and testing. Where tubes are to be fixed to wall, ceiling and flooring, the rates shall not include painting of pipes, providing sleeves and sand filling under floor for which separate payment shall be made.

- 61.3.7 The rate include painting of pipes and sand filling all round tubes for which separate payment shall not be made. The length shall be measured on running metre basis.



61.3.8 The rate shall be for a unit of one running metre.

**ITEM NO. 62 :-**

Providing & laying in trenches galvanised mild steel tubes (medium grade) TATA / ZENITH / ASIAN / JINDAL MAKE of the following nominal bore & tube fittings etc. comp.. (A) 25 mm

62.1.0 Materials :-

Galvanised mild steel tube of specified dia nominal bore and fittings shall conform to I.S. 1239:1990 [Galvanised Iron pipes and fitting shall conform to M-56].

62.2.0 Workmanship :-

62.2.1 The relevant specifications of Item No.61 shall be followed for cutting laying and jointing testing of joints except that the fixing of tube shall be done in trenches.

62.2.2 The width and depth of the trenches for different diameters of the tubes shall be as under:

62.2.3 For 15 to 80 dia tube width of trenches shall be 30 cms. and depth of trenches 60 cm.

62.2.4 At joints, the trench width shall be widened where necessary. The work of excavation and refilling shall be done true to line and gradient in accordance with general specifications of earth work in trenches.

62.2.5 The pipes shall be painted with two coats of anti-corrosive bitumastic paint of approved quality. The pipe shall be laid on a layer of 75 mm. sand filled upto 150 mm. above the pipe if so specified. The remaining portion of trench shall be then filled with excavated earth. The surplus earth shall be disposed off as directed.

62.2.6 When the excavation is done in rock the bottom shall be cut deep enough to permit the pipe to be laid and cushion of sand 75 mm. In case of bigger diameter of tube where the pressure is very high, thrust block of cement concrete 1:2:4 [1 cement:2 coarse:4 graded stone aggregate or 20 mm nominal size] shall be constructed on all bends to transmit the hydraulic thrust without impacting the ground and spreading it over a sufficient area if so specified.

62.3.0 Mode of measurements and payments :

62.3.1 The relevant specification of Item No.61 shall be followed. The authorised quantities shall be measured.

62.3.2 For purpose of calculating cubic content cross section shall normally be taken at suitable intervals i.e. manhole or wall chamber intervals, except in abnormal cases like sudden change in strata or undulating ground etc. where they may be taken at closer intervals as approved by the Engineer-in-charge whose decision shall be final, conclusive and binding.

Authorised width :-

[a] Upto one meter depth, the width of the trenches for the purpose of measurements of excavation shall be arrived at by adding 40 cms. to the external diameter of the tube [not the socket] where a pipe is laid on concrete bed/cushioning layer, the authorised width shall be the external diameter of tube plus 40 cms. or the width of the concrete bed cushioning layer whichever is more. [b] For depth exceeding one meter an allowance of 5 cms. per meter of depth for each side of the trench shall be added to the authorised width [i.e. external diameter of the pipe plus 40 cms. This allowance shall apply to the entire depth of the trench. The authorised width in such cases shall therefore be equal to the depth of trench, plus external diameter of the plus 40 cms.

[c] Where more than one tube is laid, the diameter shall be reckoned at the horizontal distance from outside to outside to outside of the outer most pipes.

[d] Where sheeting etc. has been provided the authorised width of the trenches at bottom shall be increased to accommodate for sheeting etc. so the clear width available between faces of sheeting is as per provisions of [a] [b] and [c] above.

[e] If the sides of the trench are not vertical. the toes of the side slopes shall end at the top of the pipe and vertical sided trench of authorised width as per [a] [b],[c] and [d] above shall be excavated from these down to the bed of trenches.

62.3.3 Where the tubes are laid in trenches, the work of excavation and refilling shall be paid of separately. The rate also does not include painting of pipes and sand filling all round the tubes for which separate, payment shall be made. The length shall be measured on running metre basis.

62.3.4 The rate shall be for a unit of one running metre basis.

**ITEM No. 63 :**

Providing & Fixing C.P. Brass screw down bib tap at all floor levels, polished bright etc. comp.-(A) 15mm dia. For all Floors

63.1.0 MATERIALS

63.1.1 15mm. dia. brass screw down with bright polished finish shall conform to I.S. 781-1990 & M-57. The bib cock shall be best Indian make and quality.

63.2.0 WORKMANSHIP

63.2.1 The screw down bib cock 15mm. dia. as specified above shall be fixed as directed. The threaded portion shall be smeared with white or red, lead and around with a few turns of fine spun yarn round the screwed end of the pipe. The bib cock shall be then screwed and fixed to water tight position.

63.3.0 MODE OF MEASUREMENTS & PAYMENTS



- 63.3.1 The rate includes cost of all labour, materials, tools and plant etc. required for satisfactory completion of this item.
- 63.3.2 The rate shall be for a unit of one number.

**ITEM No. 63A :**

Providing & Fixing C.P. Brass 2-WAYScrew down bib tap at all floor levels, polished bright etc. comp.-(A) 15mm dia. For all Floors

## 63.1.0 MATERIALS

- 63.1.1 15mm. dia. brass screw down with bright polished finish shall conform to I.S. 781-1990 & M-57. The bib cock shall be best Indian make and quality.

## 63.2.0 WORKMANSHIP

- 63.2.1 The screw down bib cock 15mm. dia. as specified above shall be fixed as directed. The threaded portion shall be smeared with white or red, lead and around with a few turns of fine spun yarn round the screwed end of the pipe. The bib cock shall be then screwed and fixed to water tight position.

## 63.3.0 MODE OF MEASUREMENTS &amp; PAYMENTS

- 63.3.1 The rate includes cost of all labour, materials, tools and plant etc. required for satisfactory completion of this item.
- 63.3.2 The rate shall be for a unit of one number.

**ITEM No. 64 :-**

Providing & Fixing gun metal check or non return full way wheel valve at all floors levels, etc. complete. (A) 15 mm. dia. B) 25 mm.dia.

## 64.1.0 MATERIALS

The gun metal check or non-return full way valve of specified dia. shall conform to I.S. 778-1990 & M-58. The non-return valve shall be tested quality.

## 64.2.0 WORKMANSHIP

The gunmetal check or non-return valve shall be fully cleared of all foreign matter before fixing of valve shall be done means of bolts, nuts and 3 mm. rubber insertions. with flanges of spigot and socketed tail pieces drilled to the same specification as in case of socket and with flanges in ease of flanged pipes. The joining shall be done leak proof.

## 64.3.0 MODE OF MEASUREMENTS &amp; PAYMENTS

- 64.3.1 The rate includes all labours, materials, tools and plant etc. required for satisfactory completion of this time.
- 64.3.2 The rate shall be for a unit of one number.

**ITEM No. 65 :-**

Providing & Fixing chromium plated brass half turn flush cock at all floor levels, of approved quality incl. fixing in pipe line etc. Comp.-- 25 mm dia.

## 65.1.1 MATERIALS :

Chromium plated brass half turn flush cock shall conform to M-67.

## 65.2.0 WORKMANSHIP

- 65.2.1 The half turn flush cock of specified diameter shall be fixed as directed. The flush cock shall be fixed in G.I. pipe line with necessary fittings. The joints shall be made leak proof by using spun yarn and white zinc. The fixing work shall be carried out as per relevant specifications of Item No. 62.

## 65.3.0 MODE OF MEASUREMENTS &amp; PAYMENTS

- 65.3.1 The rate includes cost of all materials and labour required for satisfactory completion of this item including fittings.
- 65.3.2 The rate shall be for a unit of one number.

**ITEM No.66 :-**

Providing & Fixing abonite ball cock of approved qualities directed etc. comp. (A) 25 mm dia. (B) 50 mm dia.

## 66.1.0 Materials

The ball cock of specified diameter shall conform to M-75.

## 66.2.0 Workmanship :

The abonite ball cock of specified diameter shall be fixed as directed. The threaded portion shall be smeared with white or red lead around with a few turns of fine spun yarn round the screwed end of the pipe. The ball cock shall be then screwed and fixed to water tight position.

## 66.3.0 Mode of Measurement and payment :

The rate includes cost of all materials and labour involved for carrying out satisfactory work.  
The rate shall be for a unit of one number.

**ITEM No.67 :-**

Providing and fixing C.I. manhole cover 0.60 x 0.45 m. size having weight not less than 35 Kg. etc. comp.

## 67.1.0 Materials :

C. I. manhole cover 0.60 x 0.45 mts. size shall be of best quality. The weight of C. I. cover and frame shall not be less 35 Kg. The C.I. manhole cover shall be of light duty.





- 67.2.0 Workmanship :  
The C.I. manhole cover shall be fixed as and where directed. The frame of manhole cover shall be embedded firmly in R.C.C. slab. After completion of work, manhole covers shall be sealed by means of thick grease.
- 67.3.0 Mode of Measurement and payment :  
The rate includes cost of all labour and materials required for satisfactory completion of this item.  
The rate shall be for a unit of one number.

**ITEM No. 68 :-**

Providing and fixing cast iron spigot and socket soil waste water and ventilating pipes of 75 mm dia & 100 mm.dia. including jointing with cement mortar 1:2 (1 cement ;2 find sand) and spun yarn as directed etc. complete.

**68.1.0 MATERIALS**

The specification dia. C.I. spigot and socket soil or waste and ventilating pipe shall conform to M-68.

**68.2.0 WORKMANSHIP**

- 68.2.1 The fixing of C.I. spigot and sockets soil, waste and ventilating pipe shall be carried out as per relevant specifications of item No. 51 except the C.I. spigot and socket shall be fixed. The joints shall be filled with cement mortar 1:2 (1 cement; 2 sand) and spun yarn. The pipes without ears shall be fixed to wall with M.S. clamps. The pipes with ears shall be secured with 40 mm. before steel or iron barrel distance pieces or bobils and strout galvanised iron nails 10 cms. long driven into hand wool plugs fixed in walls. Access doors to fittings shall be provided with 3 mm. rubber insert packings and secured without screws to make air and water tight.

The spigot of the upper pipe shall be properly fitted into the socket of the lower pipe such that there is uniform annular space. For fitting with the jointing materials one third depth of annular space between the socket and the spigot shall be filled with spun-yarn soaked in bitumen jointing compound and shall be pressed home by means of a caulking tool. The remaining 2/3 depth of the joints shall be filled in with stiff cement mortar 1:2 and shall be pressed with caulking tool and finished smooth at top at an angle of 45 degree sloping up.

- 68.2.2 All soil pipes shall be carried up above the roof and shall have a wire ballon guard or a cowl.

- 68.2.3 The ventilating pipe or shaft shall be carried out to a height of at least one metre above the outer covering of the roof of the building or in the case of windows in a gable wall or a dormer windows, it shall be carried upto the ridge of the roof or at least two metres above the top of the windows. In case of flat roof to which access for use is provided, it shall be carried out upto a height of at least one metre above the parapet or two metres measured vertically from the top of any windows or opening which may exist upto a horizontal distance of five metres from the vent pipe into such building and in no case shall be carried out to a height less than three metres.

- 68.2.4 Where ventilating pipes are carried in pipe shafts, the shaft shall be of a minimum size of one metre. If the shafts are also used to give light and air to room the ventilating pipes must be carried out to a horizontal distance at roof level of not less than five metres from the site of the shaft.

- 68.2.5 The sand cast iron pipes above parapet shall be fixed with M.S. clamps and stays. The clamps shall be made from 1.5 mm. thick M.S. flat or 3 mm. width band to the required shape and size to fit tightly on the sockets when tightened with screw bolts. It shall be formed of two semi circular pieces with flanged ends on both sides, with holes to fit in the screw bolts and nuts 40 mm. dia. M.S. bars one end of the stay shall be bent to form a hook to be fixed with clamps by means of bolts and the other end shall be bent for embedding in wall in cement concrete block of size 200mm. x 100mm. x 100mm. in 1:2:4 mix. The concrete shall be finished to match the surrounding surfaces.

- 68.2.6 The connection between the main pipe and branch pipes shall be made by using branches and bends with access doors for cleaning.

The waste from lavatories, kitchens basins, sinks, baths and other floor traps shall be separately connected to respective stacks of upper floors. The waste stack of lavatoreis shall be connected directly to main hole while the waste stack of other shall be separately discharged over gulley trap.

**68.3.0 MODE OF MEASUREMENTS & PAYMENTS**

- 68.3.1 The length of pipe shall be measured including all fittings along its length in running metres correct to a centimetre. No allowance shall be made for the portion of pipe length entered in the sockets of the adjacent pipe of fittings.

- 68.3.2 The rate includes all labours, and materials, tools and plant etc. required for satisfactory completion of this item.

- 68.3.3 The rate shall be for a unit of one running metre.

**ITEM NO. 69:-**

Providing and fixing on wall face C.I. Rain water pipe including filling the joints with spun yarn soaked in neat cement slurry and cement motar 1:2 ( 1 Cement : 2 fine sand ) etc. comp. (A) 75 mm.

**69.1.0 Materials :**

Water shall conform to M-1 The C.I. rain water pipe and fittings shall conform to M-68. Cement mortar shall conform to M-11.



- 69.2.0 Workmanship :-
- 69.2.1 C.I.rain water pipes shall be of the specified diameter and shall be in full lengths of 1.8 metres including socket ends of the pipes unless shorter lengths are required at junctions with fittings.
- 69.2.2 The pipe and fittings shall be fixed in vertical, alignment unless otherwise specified and shall be secured to the wall at joints with M.S. clamps. The clamps shall be M.S. sheet 30 mm. bent to required with and size so as to fit rightly on the socket of pipe when tightened with 6 mm.dia. M.S. Pin on one side and provided flanged ends on the other side with holes to fit in the screw bolt and nut 40 mm. long. The clamps shall be provided with hook made out of 27 mm long 10 mm.dia. M.S.bar rivetted to the ring at the centre of one semi-circular piece. The clamps shall be fixed to the walls. The clamps shall be kept above 25 mm. clear of finished face of wall so as to facilitate cleaning and painting the pipes.
- The pipe shall be fixed vertically. The spigot of the upper pipe shall be properly fitted in the lower pipe such that there of uniform annular space for filling with the joining materials. The annular space between the spigot and socket shall be filled with a few turns of spun yarn soaked in cement slurry or blow bitumen 85/25 grade. These shall be pressed home by caulking tools. The joints shall then be fitted with stiff cement mortar 1:2 [ 1 cement :2 fine sand ] well pressed with caulking tools and finished smooth at top at an angle 45 sloping up. The joints shall be kept wet at least for 7 days by tying four folds of gunny bag to the pipe and keeping it moist constantly.
- 69.3.0 Mode of measurements and payments :
- The pipe shall be measured including of fittings along its length in running metre. No allowance shall be made for the portion of pipe length entering the sockets of the adjacent pipe or fittings.
- The rate includes the cost of all materials and labour involved in all the operations including jointing.
- The rate shall be for a unit of one running metre.

**ITEM NO.70 :-**

Providing and fixing on wall face asbestos cement rain water pipe including jointing with spun yarn soaked in bitumen and cement 1 :2 [1 cement : 2 coarse sand] etc.comp.[A] 80 mm dia [B] 100 mm dia.

- 70.1.0 Materials :-
- Asbestos cement pipes of specified dia shall conform to I.S.1626:1994 for pipes fixed on wall face A.C. pipe shall conform to M-74.
- 70.2.0 Workmanship:-
- Asbestos cement rain water pipes and fittings shall be of the diameter, size and type specified in the item as required. The pipe shall be fixed in full lengths of 2 metre as far as possible. All the pipes shall be fixed on wall face at locations indicated on drawings or as ordered by the Engineer-in-charge. Pipe shall be secured to face of wall below all joints by M.S.clamps with wooden gutties.
- The spigot of the upper pipe shall be properly fitted into the socket of the lower pipe such that there is uniform annular space for fitting with jointing materials. One third depth of annular space between the socket and the spigot shall be filled with spun yarn soaked in bitumen jointing compound and shall be pressed home by means of a caulking tool. The remaining 2/3 depth of the joints shall be filled in with stiff cement mortar 1:2 and shall be pressed with caulking tool and finished smooth at top an angle of 45 degree sloping up.
- 70.3.0 Mode of Measurements and payments :-
- The pipe shall be measurement including all fittings along its length in running metre. No allowance shall be made for the portion of pipe length entering the sockets of the adjacent pipe or fittings.
- The rate includes the cost of all materials and labour involved in all the operations including jointing.
- The rate shall be for a unit of one running metre.

**ITEM NO.71 :-**

Providing & fixing M.S. Holder Bat clamps at all floor levels of approved design to C.I. Or S.C.I pipes including the cost of cutting holes & making good the wall etc. Complete - 100 mm. dia. (M.R.)

- 71.1.0 Materials and Workmanship :-
- The M.S.Holder bat clamps of approved design shall be for C.I.rain water pipe 75 mm.dia.
- The bat clamps shall consist of a cast iron base with a projecting I shaped lay, teeth web of which the semi circular halves of the flat iron clamps are bolted. The base on the holder bat clamp shall be screwed on a pair of wooden plugs fixed in the wall with screw slotted driven through the holes in the base. The screws shall not be less than 75 mm. long for 80 mm. diameter pipes. The plugs shall be fixed in the wall to a depth of 150 mm in cement mortar 1:2 centrally to the holes in the base of the bat clamps and with their front face projecting to such a length from the brick face that when the bat clamps is fixed, the outer base of its base shall be flush with the plaster face of the wall. The plugs shall be 110 mm. x 50 mm.wide at take increasing to 160 mm. x 70 mm. width at rear and shall be 70 mm.deep through out.
- The bat clamps shall be fixed as directed with C.C. blocks of 100 mm x 100 mm x 100 mm size. The relevant specifications of item No.17 shall be followed for concrete work.
- 71.2.0 Mode of measurement and payments :-
- The bat clamp of M.S. Holder suitable for 35 mm.dia shall be measured for finished item.
- The rate includes cost of all materials etc. required for satisfactory completion of this item.
- The rate shall be for a unit of one number.

**ITEM NO.71A :-**

P Providing & fixing G.I. Z- Clamps ( 3" Gap, 16 Gauge) with PVC Coated (8mm) U- Bolts at all floor levels of approved design to C.I. Or P.V.C. pipes including the cost of cutting holes & making good the wall etc. Complete

**71.1.0 Materials and Workmanship :-****The G.I. Z- Clamps**

PVC Coated (8mm) U- Bolts of approved design shall be for C.I or PVC.rain or wast water pipe 75 & 110 mm.dia.The bat clamps shall consist of a cast iron base with a projecting I shaped lay, teeth web of which the semi circular halves of the flat iron clamps are bolted. The base on the holder bat clamp shall be screwed on a pair of wooden plugs fixed in the wall with screw slotted driven through the holes in the base,The screws shallnot be less than 75 mm. long for 80 mm. diametre pipes. The plugs shall be fized in the wall to a depth of 150 mm in cement mortar 1:2 centrally to the holes in the base of the bat clamps and with their front face projecting to such a length form the brick face that when the bat clamps is fixed, the outer base of its base shall be flush with the plaster face of the wall. The plugs shall be 110 mm. x 50 mm.wide at take increasing to 160 mm. x 70 mm. width at rear and shall be 70 mm.deep through out.  
The bat clamps shall be fixed as directed with C.C. blocks of 100 mm x 100 mm x 100 mm size. The relevent specifications of item No.17 shall be followed for concrete work.

**ITEM NO.72 :-**

Providing and fixing on wall face asbestos cement fittings for rain water pipe including jointing with spun yarn soaked in bitumen and cement mortar 1:2 [ 1 cement: 2 coarse sand] etc. complete Bend of required degree [A] 80 mm dia without door.

**72.1.0 Materials :**

The bend of required degree and size as specified in item shall be best quality and make as approved by the Engineer-in- charge. The fitting shall conform to I.S. 1626:1994 M-74.

**72.2.0 Workmanship :-**

The fitting [ bends required degree ] shall be fixed as per relevant specifications of Item No. 43 except that the A. C. bends or required degree shall be provided instead of pipe.

**72.3.0 Mode of measurements and payments :-**

The rate shall be for a unit of one number.

**ITEM NO.73 :-**

Providing and fixing on wall face asbestos cement fitting for A.C. rain water pipe including jointing with spun yarn soaked in bitumen and cement mortar 1:2 [1 cement : 2 coarse sand] etc. comp. [A] Standard shoe 80 mm dia [B] 100 mm dia.

**73.1.0 Materials and workmanship :-**

The relevant specification of Item No. 72 shall be followed except that the standard shoe of A.C. pipe of specified size shall be provided instead of bend.

**73.2.0 Mode of measurements and payments :-**

The rate shall be for a unit of one number.

**ITEM No.74 :-**

Providing & Fixing in position PVC Cowl vent to pipes of Prince/Supreme/Jain/Astral/Tulsi/Finolex make etc.Comp. (A) 75 mm Dia. (B) 100 mm Dia.

**74.1.0 Materials :**

Cowl vent shall conform to I.S.1626:1994 for pipes fixing A.C. pipe cowl vent conform to M-74.

**74.2.0 Workmanship :**

Cowl vent diameter size and type shall be specified in the item. All cowl vent shall be fixed at location indicated on drawings or as directed by Engineer-in-charge. Cowl vent shall be secured to face of wall below all joints by M.s.clamps with wooden gutties.

**74.3.0 Mode of measurement and payment :**

The rate includes all labour materials tools and plants etc. required for satisfactory completion of this item.  
The rate shall be for a unit of one number.

**ITEM No.75 :-**

Providing & fixing G.I. Rain water spout of 50 mm.dia & 30 cm length etc.

**75.1.0 Materials :**

G.I.M.S. tube of 50 mm dia shall conform to M-56.

**75.2.0 Workmanship :**

The G.I. pipe of 30 cms fixed as rain water pipe as directed. The pipe shall be fixed about 1/4 dia below the floor level so as to make approach of water easy. The inlet of pipe shall be rounded of for easy entry of rain water pipe. The pipe shall be fixed in C.M.

**75.3.0 Mode of measurement and payment :**

The rate includes cost of all labour and materials required for satisfactory completion of this item.  
The rate shall be for a unit of one number.

**ITEM No.76 :-**

(A) Providing & laying ordinary C.C.1:1.5:3 mix for R.C.C. work incl. boxing, centering, vibrating, curing & mixed with approved water proofing cement compound or "CEMWET" or "PIDICRETE LW" integral water proofing admixture as water proofing agent to be mixed with 50 kg. cement bag shall be as recommended by the manufacture of the water proofing material, concrete work for top, bottom slab & side pardi for under ground Tank & Item incl. Necessary excavation & refilling the available earth, 15 cm th' C.C 1:4:8 for bedding concrete, Half B.M. in C.M. 1:4 outside wall, inside R.C.C. pardi as per design, 10mm.th. water proofing cement plaster in C.M. 1:3 with smooth finishing, watering etc. Comp. to all inner face & bottom of tank curing etc. comp. incl. Locking arrangement, outlet, inlet, overflow & wash out pipe arrangement as necessary & C.I. Cover 0.60 x .045 weight not less than 35kg. etc. com. as per structural drawing excluding Steel & as directed by Engineer-in-charge (A) Underground tank

Item includes necessary excavation and refilling available earth, 15 C.M. thick C.C. 1:4:8 for bedding concrete, 10 mm. thick water proofing cement plaster in C.M. 1:2 with smooth finishing watering etc. complete to all inner face of tank and 20 mm thick sand face cement plaster consisting base coat of 12 mm thick in C.M. 1:3 and 8 mm thick.

Finishing coat of C.M.1:1 on outer surface of tank, Curing etc. comp. including locking arrangement, outlet, inlet, overflow and washout pipe arrangement as necessary etc. comp. as per structural drawing and as directed by Engineer-in-charge etc. comp. For under ground water tank and over head water tank.

**76.1.0 Material :**

Water shall conform to M-1. Cement shall conform to M-3. Graded stone aggregates 20 & 40 mm nominal size shall conform to M-12, sand shall conform to M-6, Grit shall conform to M-8. The shuttering to be provided shall be of ordinary timber and shall conform to M-26, cold twisted steel bars (High yield strength deformed steel bars shall conform to M-19. Cement mortar shall conform to M-11. G.I. pipe shall conform to M-56. Mild steel binding wire shall conform to M-21.

**76.2.0 General :**

The item covers constructing R.C.C., under ground or overhead water tank as detailed specified in the item.

**76.2.1 Workmanship :**

The relevant specification of Item No.1 (a.b.) shall be followed for excavation work except that work shall be carried out for under ground water tank.

The relevant specification of Item No.2 shall be followed for 15 cm thick bedding concrete work. Except that the proportion shall be 1:4:8 for under ground water tank.

The relevant specification of Item No.5 shall be followed for R.C.C. work. Except that works shall be carried out for water tank in ordinary M-200 i.e. 1:1 1/2:3 proportion volume including boxing centering, vibrating curing and mixed with approved water proofing cement compound or CEMWET as water proofing agent to be mixed with 50 Kgs. bags shall be used recommended by the manufactures of the water proofing materials. Concrete work for top, bottom slab and side pardi for under ground and over head water tank.

The relevant specification of Item No.7 shall be followed for H.Y.S.D. bars/M.S. bars steel reinforcement for under ground and overhead water tank R.C.C. work.

The relevant specification of Item No.15 shall be followed for 10 mm thick cement plaster in proportion 1:2 except that works shall be carried out for water tank including mixing with approved water proofing cement compound for all inner surface or water tank.

The relevant specification of Item No.19 shall be followed for 20 mm thick sand face cement plaster consisting base coat of 12 mm thick in C.M. 1:3 and 8 mm thick finishing coat of 1:1 on outer surface of tank. Except that the work shall be carried out for water tank.

The relevant specification of Item No. 61 and 62 shall be followed for outlet, wash out and over flow pipe as directed by Engineer-in-charge. Locking arrangement or water tank shall be provided as directed by Engineer-in-charge.

**76.4.0 Mode of measurement and payment :**

The rate includes cost of all labours, materials tools and plants etc. required to satisfactory completion of this item as specified in detailed.

The rate shall be for a unit of one litre.

**ITEM No.77 :-**

Extra for providing and mixing water proofing material as "CEMWET" or Equivalent as per I.S. 9103- 1979 requirement and approved by Engineer-in-charge in cement concrete in mix proportion 200 gm./50 Kg. of bag. or recommended by the manufacturer etc. comp.

**77.2.0 Workmanship :**

The proportions of materials for the cement concrete shall be mentioned with the specifications of that item.

The quantity of water proofing materials to be added and the method of addition shall be as specified by manufacture.

**77.2.1 Mixing :**



The mixing of the water proofing materials in cement, water, or concrete shall be done according to the specifications of the manufacturer.

77.3.0 Mode of Measurements and payments :

The payment is extra over and above the rate of concrete for mixing water proofing powder.

The rate shall be for a unit of 200 gm./50 kg.of cement bag.

**ITEM NO. 78 :**

Providing and laying cement concrete 1:1.5:3 (1 Cement, 1.5 coarse sand : 3 graded stone aggregate 20 mm nominal size) and finishing smooth with cement plaster in cement mortar 1:3 and curing etc. complete for above floor two level including cost of form work but excluding the cost of reinforcement for R.C.C. work in.

(A) Column :

( i) Having cross sectional area 0.05 to 0.08 Sq.metre.

( ii) Having cross sectional area 0.08 to 0.12 Sq.metre.

(iii) Having cross sectional area 0.12 to 0.18 Sq.metre.

78.1.0 MATERIALS AND WORKMANSHIP :

The relevant specification of Item No.3 shall be followed except that the proportion of concrete shall be of 1:1.5:3 and the work shall be carried out for super-structure above floor two level.

78.2.0 MODE OF MEASUREMENT AND PAYMENT :

The relevant specifications of item No.3 shall be followed. The extra payment shall be made for additional lift above floor two level to each additional floor over and above. The rates of concrete work shall be measured and paid under this item.

The rate shall be for a unit of one Cu.meter per floor.

**ITEM NO.79:-**

Providing and laying Rough chiselled dressed [kotah stone green] stone flooring over 20 mm thick base of cement mortar 1:5 [ 1 cement : 5 coarse sand] or L.M. 1:1.5 including pointing with cement mortar 1:2 [ 1 cement :2 stone dust] etc. complete 25 mm thick.

79.1.0 Materials :-

79.1.1 Water shall conform to M-1. Lime mortar shall conform to M-10 cement mortar shall conform to M-11. Rough chisel dressed stone shall conform to M-48.

79.2.0 Workmanship :-

79.2.1 The relevant specifications of item No.44 shall be followed except that the rough chisel dressed stone of 25 mm. thickness of approved quality are to be fixed in cement mortar bedding in C.M.1:5 or L.M. 1:1.5 of 25 mm.average thickness.

79.2.2 Dressing of stone slab :-

Every stone slab shall be cut to the required size and shape and rough chisel dressed on top as required, so that the dressed surface shall not be more than 6 mm. from straight edge placed on it. The sides shall also be chisel-dressed to a minimum depth of 20 mm.so that the dressed edge shall at no place be more than 30 mm. From straight edge huted against it. Beyond this depth, the sides may be dressed slightly splayed so as to form an inverted 'V' shaped joint with adjoining slab. The surface shall be reasonable true and plane and all the angles and edges shall be square and free from chipping. Where the stone slabs are to be used for nosing, exposed shall be rough chisel dressed to full depth and cut to the uniform thickness.

The thickness of the stone slab shall be 25 mm with permissible tolerance of + 2 mm.

79.2.3 Laying :-

The surface of the sub- grade concrete shall be cleaned, wetted and mopped. The bedding of specified mortar mix shall be spread under each slab to the specified thickness. The slab shall be washed clean before laying. It shall then be laid on top, pressed so that all hollows underneath filled with surplus mortar works up through the joints. The top shall be tapped and brought level to the adjoining slab. The thickness of the joints shall not exceed 5 mm. Subsequent slabs shall be laid in the same manner.

79.2.4 Curing and Finishing :-

Any surplus mortar on the surface of the slab shall be cleaned off and joints finished flush. The joints shall be raked out uniformly to a minimum depth of 12 mm when the mortar is still green. The slabs which are fixed in the floor adjoining the wall shall enter not less than 12 mm. under the plaster, skirting or dado. The junctions between wall plasters end floor shall be finished neatly and without waviness. The pointing shall be done with CM 1:2 the pointing shall be cured for a minimum period of seven days. The finished floor shall not sound hollow when tapped with wooden mallet and the finished surface shall be true to level and slopes as directed.

79.3.0 Mode of measurements and payments :-

The relevant specification of Item No.44 shall be followed.

The rate shall be for a unit of one Sq.Metre.



**ITEM No. 80 :-**

Providing and fixing at all floor levels, both face polished machine cut edge marble stone slab for urinal partition joined with grey cement slurry polishing etc. complete.

**80.1.0 MATERIALS**

Water shall conform to M-1. Lime mortar shall conform to M-10 Cement mortar shall conform to M-11. Marble stone slab 25mm. thick shall conform to M-51.

**80.2.0 WORKMANSHIP**

The marble stone slab of both faces polished shall be used. The thickness of stone shall be 25 mm. The allowable tolerance shall be 2mm. The tolerance shall be +/- 5mm. in length and breadth.

For fixing of the slab grooves of appropriate size shall be cut out into the masonry of R.C.C. wall and/or slab as required in appropriate position and making holes to receive any pipes etc. The partition slab shall be fixed securely in wall and/or the slab in required position by using C.M. 1:6 to get a firm grip, the slab shall be embedded in the wall and/or in the flooring for a depth of not less than 25mm. or as directed by the Engineer-in-charge whichever is maximum. Grouting of the joints shall be done in neat ordinary white or colour cement to match the adjoining surface as directed by the Engineer. The mortar shall be cured for 14 days. The partition slab shall be cleaned with water and all mortar droppings or stains shall be removed. The slab shall be given required shape as shown on the drawings or as directed by the Engineer.

**80.3.0 MODE OF MEASUREMENTS & PAYMENTS**

The rate includes cost of all materials, labours, tools and plants etc. required for satisfactory and completion of this item.

The rate shall be for a unit of one Sq.Mts. Dimensions shall be measured for the visible area only.

**ITEM NO. 81 :**

Providing and fixing ventilator of partly fixed and partly top hung gully glazed 25 mm thick shutter including Indian teak wood framed 10 cm x 7 cm size including black enamelled iron oxidised fixtures and fastening, including primer coat of approved quality and two coats of oil painting etc.

Providing wood work in frames of doors, windows and ventilator and other similar works wrought framed and fixed in position.

**81.1.0 MATERIALS :**

Wood in frames shall conform to M-29, Glass shall conform to M- 38. Fixtures and fastening shall conform to M-43, paints shall conform to M-44.

For other detail specification refer item no.25 above except the 25 mm thick shutter shall be provided instead of for 35 mm thick shutter for ventilator of partly fixed and partly top hung fully shutter.

**81.2.0 MODE OF MEASUREMENT AND PAYMENT :**

(1) The rate includes cost of all materials, labours tools and plants required to complete the item.

(2) The rate of this item includes cost of providing block and clear for keeping the shutter in open position if directed.

(3) The item shall be measured out to out and paid on one Sq.mt. basis.

**ITEM NO. 82 :**

Conveying, carting and removing of the surplus excavated stuff from the site to any place within the Municipal limit as directed by the Engineer- in- charge including loading, unloading, carting, dumping and/or spreading as directed etc. complete.

**82.1.0 WORKMANSHIP :**

82.1.1 The contractor has to convey the surplus excavated stuff from the site to the place within the municipal limit shall be dumped and/or spread in such a way as not to obstruct the path of vehicles but it shall also make approach to lay the earth beyond that dump. Neither any excuse for difficulties for passing the vehicle over the dumped earth shall be allowed nor any extra charge will be paid to the contractor for the same.

82.1.2 The conveying of earth shall be done in such a manner that it should not cause any delay in the progress of the work.

82.1.3 During the conveying of the earth due care should be taken that the earth should not be misused or wasted. The contractor shall have arranged to collect the mix-spread earth with his own cost.

82.1.4 The earth should be loaded, unloaded and spread or dumped in the presence of the Engineer-in-charge or his representative.

**82.2.0 MODE OF MEASUREMENTS AND PAYMENT :**

82.2.1 The conveyed earth shall be measured by the measurement of the conveying vehicles. The measurement shall be recorded by the Engineer- in- charge or his representative and shall be countersigned by the contractor or his representative in token of his acceptance.

82.2.2 The rate shall be for a unit of a cubic metre.

**ITEM NO. 83 :**

Providing and fixing rolling shutter of approved make, made of 30 mm wide M.S. laths inter locked together entire length and jointed together at the ends by locks mounted on specially designed pipe shafts with bracket plates. Guide



channels and arrangements for inside and outside locking with push pull operation complete excluding the cost of hood cover and spring.

83.1.0 WORKMANSHIP :

83.1.1 Rolling Shutter :

The rolling shutter shall conform to I.S. 6248-1979. Rolling shutter shall be supplied of specified type with accessories. The size of the rolling shutter shall be specified in the drawings. The shutter shall be constructed with interlocking lath sections formed from cold rolled steel stripes not less than 0.9 mm thick and 80 mm wide for shutters upto 3.5 mt. width and not less than 1.25 mm thick and 2.00 mm wide for shutter 3.5 mt. in width and above unless other specified.

Guide channels shall be of mild steel deep channel section and of rolled pressed or built up (fabricated) jointless construction. The thickness of sheet not be less than 3.15 mm.

The rolling shutter shall be of self rolling type upto 8 Sq.mt. clear area without ball bearing and upto 12 Sq.m. clear area with ball bearing. If the rolling shutters are of larger, than gear operated type shutters shall be used.

The locking arrangement shall be provided at the bottom of shutters at both ends. The shutter shall be opened from outside.

The shutters shall be completed with door suspension shafts locking arrangements, pulling hooks handles and other accessories.

83.2.0 MODE OF MEASUREMENT AND PAYMENT :

(i) The rolling shutter shall be measured on Sq.mt. basis, the height of the shutters shall be measured out side to cut of guide rail and width out side to out side of shutters including vertical channels. The rate includes providing handles locking arrangements, other accessories etc. complete.

(ii) The rate includes cost of all materials, labour tools, and plant required to complete the item as specified.

(iii) The rate shall be for a unit of one Sq.mt.

**ITEM NO.84 :**

Providing and finishing 27.5 cm long wires pring grade No.2 of approved make for rolling shutter.

84.1.0 WIRE SPRING :

The spring shall be of best quality and all be manufactured from tested high tensile spring steel wire of strip of adequate strength to balance the shutters in position. The spring pipe shafts etc. shall be supported on strong M.S. or malleable C.I. brackets. The brackets shall be fixed on or under the lintel as specified with rawl plugs screws bolts etc.

84.2.0 MODE OF MEASUREMENTS AND PAYMENT :

(i) The rate includes cost of all materials, labours, tools, and plant required to complete the item as specified.

(ii) The rate shall be for a unit of one Number.

**ITEM No. 84A**

Providing & Fixing P.V.C. pipes (SCH-80) of Prince/ Supreme/ Jain/ Astral/ Tulsi/Finolex make for water supply line at all floor levels incl. fixtures like bends, tees, shoe etc joined with resin of approved brand & manufacture etc. comp. Pipe shall be fixed on the wall the help of clamp at every two meter C/C or shall be concealed as directed including necessary fittings etc. including testing of pipe and joints and fixing the same with adhesive solvent, including cost of all materials.

A) 15 mm Dia

(B) 25 mm Dia

(C) 40 mm Dia

(D) 50mm. dia.

(E) 65mm. dia.

84.1.1 The relevant specification of U-PVC pipes shall be followed for this item. The P.V.C. pipes shall be of SCH-80 of Prince, Supreme, Jain, Astral or Tulsi make for water supply of required diameter. All the fixtures like bend, tees, shoes etc shall be used for line and jointed with resin of approved brand.

84.1.2 The pipe line shall be fixed on the wall and floor as per detail. The joint shall be leak proof and the test shall be done with required pressure of water. The work shall be carried out as per detail and directed by engineer in charge.

84.1.3 The rate shall be for a unit of R.mt.

**ITEM NO.85 :**

Providing fixing hood covers for rolling shutters having width below 3.5 mt.

85.1.0 HOOD COVER :

Hood cover shall be made of M.S. sheets not less than 0.92 mm thick for shutters having width 3.5 mt. and the thickness of M.S. sheets for the hood cover shall be not less than 1.25 mm for shutters having width more than 3.5 mt.

85.2.0 MODE OF MEASUREMENTS AND PAYMENT :

(i) The rate includes cost of all materials, labours tools and plant required to complete the item as specified.

(ii) The length of hood cover shall be measured from inside to outside.



(iii) The rate shall be for a unit of one running meter.

**ITEM NO. 86 :**

Providing & fixing in position collapsible steel shutters with vertical channels 20 x10 x 2 mm. Braced with flat iron diagonals 20 x5mm size with top & bottom rails of T-iron 40x40x6mm. with 38mm dia. steel pulleys comp. with bolts, locking arrangements, stoppers, handles incl. applying a priming coat of Redlead paint etc. comp.

**86.1.0 MATERIALS :**

The collapsible steel gate shall conform to M-33.

**86.2.0 WORKMANSHIP :**

Rails shall be fixed to the floor and to the lintel at top by means of anchor bolts, embedded in cement concrete of floor and lintel. The anchor bolts shall be placed approximately at 45 mm. centers alternatively in the two flanges of the T-Iron. The bottom runner (T-Iron) shall be embedded in the floor and proper groove shall be formed along the runner for the purpose. The collapsible gate shall be fixed at the sites by fixed the end double channels in the T-Iron rail and also by holdfasts bolted to the end double channel and fixed in the masonry of the side walls or the otherwise.

In case where the collapsible gate is not require to the lintel, beams or slab above a tee iron suitable design may be fixed at the top embedded in masonry and provided mason with necessary clamps and roller arrangement at the top.

All the adjoining work damaged while fixing of gate shall be made good to match the existing work without any extra payment.

All members of the collapsible gate including T-Iron shall be thoroughly cleaned to rust, scales, dust etc. and given a priming coat of red lead, before fixing them in position.

**86.3.0 MODE OF MEASUREMENTS & PAYMENT :**

The collapsible gate shall be measured in sq.mt.. The height of the gate shall measured as the length of double channels and breadth from outside to outside of the end fixed double channels in open position of the gate. The rate including providing handles, locking arrangements, stoppers etc.

The rate shall be for a unit of one sq. metre.

**ITEM NO.87 :-**

Providing, mixing laying 25 mm thick IPS Topping (1:2:4) by volume on bottom slab of underground water tank as per IS:2571 with mixing of non metallic floor hardner of approved make as per manufacturer's specification including compacting, finishing curing etc.complete as directed by the Engineer- in-charge.

**87.1.0 Material :-**

Water shall conform to M-1. Cement shall conform to M-3. Sand shall conform to M-6. Stone aggregate 12.5 mm nominal size shall conform to M-12. Cement concrete to of 1: 2.5 : 3.5 proportion measured by volume shall conform to relevant specifications of ordinary grade concrete.

**87.2.0 Workmanship :**

**87.2.1**

The cement concrete flooring of 25 mm thick (Average) is to be laid as per the site condition. The concrete shall be mixed in a mechanical mixer-at the site of work.Hand mixing may however be allowed for smaller quantities of work and in case of failure of machineries or as permitted by the Engineer-in- charge. It shall be carried out on a water tight platform and care shall be taken to ensure that mixing is continued until the mass is uniform in colour and consistency. However,in such cases 10% more cement than otherwise, required shall have to be used without any extra cost. The mechanical mixing shall be done for a period of 1.5 or 2 minutes. The quantity of water shall be just sufficient to produce a dense concrete of required workability for the purpose. Flooring of specified thickness shall be laid in accordance with approved pattern or as directed. Finishing operation shall start shortly after the cessation of beating and shall be spread over period of one to six hours depending upon the temperature and atmospheric condition. The surface shall be left for some time till moisture disappears from it. Fresh quantity of cement shall be mixed with water to form a thick slurry and spread over the surface while the concrete is still green use of dry cement or cement and sand mixture sprinkled on this surface to stiffen the concrete or absorb excessive moisture shall not be permitted. The cement slurry shall then be properly pressed twice by means of iron floats once when the slurry is applied and the second time when cement starts setting and finished floated smooth. The surface shall be marked with starting or B.R.C.fabric jali to Make the surface non-slippery as and when directed. The junction of floors with wall plaster, dado or skirting shall be rounded off where so required upto 25 mm radius. Flooring in lavatories and bath rooms shall be laid after fixing of water closet and squatting pans and floor traps which shall be plugged while laying the floors and opened after the floors are completed. Any damage done to water supply/or sanitary fitting during execution of work shall be made good.

After the final set, the concrete shall be kept continuously wet, if required by ponding for period of not less than 7 days from the date of placement.

Prior to the laying of cement concrete flooring, non metallic floor hardner of approved make shall be mixed/laid as per the instruction of the Engineer-in-charge.

The form work shall be provided if necessary as directed by the Engineer- in- charge. Concreting shall be done as per alternate by method with necessary centering either by mastic or cement mortar as directed.



87.3.0 Mode of measurements and payment :

87.1.0 The rate shall include the cost of all materials and labour involved in all the operations described above. No deduction shall be made or extra paid for any opening upto 0.1 Sq.mt. In area in the floor nothing extra shall be paid for laying the floor at different levels in the same room or the courtyard.

The rate shall be for a unit of one Sq.Meter.

**ITEM NO.88 :-**

Providing and laying cement concrete 1: 4: 8 (1 cement : 4 coarse sand : 8 graded stone aggregates 40 mm nominal size) and curing complete including cost of formwork in: (A) Foundation and plinth

88.1.0 Materials:-

Water shall conform to M-1. Cement shall conform to M-3. Sand shall conform to M-6. Stone aggregate 40 mm nominal size shall conform to M-12.

88.2.0 WORKMANSHIP :

88.2.1 General :-

Before starting concreting the bed of foundation trenches shall be cleared of all loose materials, levelled, Waterred and rammed as directed.

88.2.2 Proportion of Mix :-

The proportion of cement, sand coarse aggregate shall be one part of cement, 4 parts of sand 8 parts of stone aggregate shall be measured by volume.

88.2.3 Mixing :-

The concrete shall be mixed in a mechanical mixer at the site of work. Hand mixing may however be allowed for smaller quantity of work if approved by Engineer-in-charge. When hand mixing is permitted by the Engineer-in-charge in case of break down of machineries and in the interest of the work, it shall be carried out on a water tight platform and care shall be taken to ensure that mixing is continued until the mass is uniform in colour and consistency. However in such case 10% more cement than otherwise required shall have to be used without any extra cost. The mixing in mechanical mixer shall be done for a period 1 1/2 to 2 minutes. The quantity of water shall be just sufficient to produce dense concrete of required workability for the purpose.

88.2.4 Transporting and placing the concrete :-

The concrete shall be handed from the place of mixing to the final position in not more than 15 minutes by the method as directed and shall be placed into its final position, compacted and finished within 30 minutes of mixing with water i.e. before the setting commences.

The concrete shall be laid in layers of 15 cms to 20 cms.

Compacting :-The concrete shall be rammed with heavy iron rammer and rapidly to get the required compaction and to allow the interstices to be filled with mortar.

88.2.5 Curing :-

After the final set, the concrete shall be kept continuously wet, if required by ponding for a period of not less than 7 days from the date of placement.

88.3.0 Mode of measurements and payment :-

The concrete shall be measured for its length breadth and depth, limiting dimensions to those specified on plan or as directed. The rate shall be for a unit of one cubic meter.

**ITEM NO.88A :-**

Providing and laying cement concrete flooring 1:2:4 (1 cement : 2 coarse sand : 4 graded stone aggregate 20mm nominal size) laid in one layer finished with a floating coat of neat cement(B) 50mm thick

Details specification as per item No.88 but read 1:2:4 instead of 1:4:8 and as directed by Engineer-in-charge.

Mode of measurements and payment :-

The concrete shall be measured for its length breadth and depth, limiting dimensions to those specified on plan or as directed. The rate shall be for a unit of one Sq.meter.

The concrete shall be measured for its length breadth and depth, limiting dimensions to those specified on plan or as directed. The rate shall be for a unit of one Sq.meter.

**ITEM NO.88B :-**

Providing & laying cement concrete 1:5:10 (1 cement:5 sand:10 graded stone agg. 40 mm nominal size) & curing comp. incl.cost of form work in 75 mm thick and curing complete

Details specification as per item No.88 but read 1:5:10 instead of 1:4:8 and as directed by Engineer-in-charge.

Mode of measurements and payment :-

The concrete shall be measured for its length breadth and depth, limiting dimensions to those specified on plan or as directed. The rate shall be for a unit of one Sq.meter.

**ITEM NO.89(A)**

NOTE :-



- (1) The whole work is to be executed through specialised agency with a guarantee of 10 (Ten) years given on a prescribed proforma duly stamped (2) The rate shall include for work at all floors and conducting water proof test as directed.
- (A) Providing and laying integral cement based water proofing treatment including preparation of surface as required for treatment of roofs, balconies, terraces etc. consisting of following operations.
- (a) Applying and grouting a slurry coat of neat cement using 2.75 Kg./Sq.m. of cement admixed with proprietary water proofing compound conforming to IS:2645 over the R.C.C. slab including cleaning the surface before treatment.
- (b) Laying cement concrete using broken bricks/brick bats 25 mm to 100 mm size with 50% of cement mortar 1:5 (1 Cement : 5 Coarse sand) admixed with proprietary water proofing compound conforming to IS:2645 over 20 mm thick layer of cement mortar 1:5 (1 Cement : 5 coarse sand) admixed with proprietary water proofing compound conforming to IS:2645 to required slope and treating similarly the adjoining walls upto 300 mm height including rounding of junctions of walls and slabs.
- (c) After two days of proper curing, applying a second coat of cement slurry admixed with proprietary water proofing compound conforming to IS:2645.
- (d) Finishing the surface with 20 mm thick jointless cement mortar of mix 1:4 (1 Cement : 4 Coarse sand) admixed with proprietary water proofing compound conforming to IS:2645 and finally finishing the surface with trowel with neat cement slurry and making of (300 x 300) mm square.
- (e) The whole terrace so finished shall be flooded with water for a minimum period of two weeks for curing and for final test. All above operations to be down in order and as directed and specified by the Engineer-in-charge. With average thickness of 120 mm and minimum thickness at khurra as 65 mm. (Cement consumption 0.642 Bags/S.M.).

Details specification same as per Item and as instruction by Engineer-in-charge.

The rate shall be for a unit of one Sq.Meter.

**ITEM NO.89(B)**

- (B) Providing & laying water proofing treatment to vertical and horizontal surfaces like consisting of (a) I course of applying cement slurry 4.4 kg per sq.mt. mixed with water proofing compound conforming to IS:2645 in recommended proportions. (b) II course of 20mm cement plaster 1:3 mixed with water proofing compound in recommended proportion (c) III course of applying blown or / residue bitumen applied hot at 1.7 kg per sqm of area. (d) IV course of 400mm micron th. PVC sheet. (Overlaps at joints of PVC sheet should be 200mm wide and pasted to each other with bitumen about 1.7 kg./sqm.)

Details specification same as per Item and as instruction by Engineer-in-charge.

The rate shall be for a unit of one Sq.Meter.

**ITEM NO.89-C :-**

- Providing and filling in depressions of Bath and W.C. at all floor levels, after completing plumbing work of pans, pipes, traps etc., with cinder or fly ash as directed by Engineer in charge etc.comp.

89.1.0 Material :

Water shall conform to M-1.Cement shall conform to M-3. Sand shall conform to M-6. Brick bat shall conform to M-14, Water proofing compound shall be "CEMWET" or shall conform to I.S. 9103- 1979. Mortar shall conform to M-11.

89.2.0 Workmanship :

89.2.1 General :

Before starting the operation of concreting the surface of base shall be well cleaned.

89.2.2 Proportion of Mix and Mixing :

The proportion of cement,sand, aggregate and water proofing power shall be as specified in the item of the work.

The concrete shall be hand mixed over smooth watertight platform, large enough to allow efficient turning over the ingredients of concrete before and after adding water. Platform shall be so arranged that no foreign material get mixed with concrete nor does mixing flow out. Dry coarse and fine aggregate, cement shall water proofing compound shall then be mixed thoroughly by turning over to get a mixture of uniform colour.

Specified quantity of water shall then be added gradually through a rose can and the mass turned over till a mix of required consistency is obtained.

89.2.3 Laying and compacting :

Concrete shall always be used while quite fresh,it shall be laid (not thrown) in layers not exceeding 150 mm in thickness and shall be well and quickly rammed with wooden or iron rammers till the required compaction is achieved. The concrete laid shall not be of too fluid consistency.After it has been mixed,no more water shall be added, but the surface during and after compaction shall be kept damp. In laying consecutive layers, the layer cast shall be well watered and made rough before the upper layer is laid. The concrete shall be kept continuously wet for a period of seven (7) days from the date of placing or untill it is built over which ever is more.

89.3.0 Mode of measurements and payment :

The rate shall include the cost of all materials, tools, and labour involved in all the operation described above. Concrete work shall be measured in length,breadth,and depth as specified on drawing or as directed correct upto nearest CM and cubical content shall be worked out up to two places of decimals.





The rate shall be for a unit of one cubic metre.

**ITEM NO. 90:-**

Boring holes 3.5 mt deep in ordinary soil(for cast in situ piles) & disposal of the surplus excavated soil as directed within lead of 50 mt. (i) 200 mm (ii) 250 mm (iii) 300 mm.

## 1.1 Workmanship :

1.1 The ground shall be roughly levelled and after making the position of piles, holes shall be bored with a spiral angle to the 2.50 m. depth and specified diameter using boring guide.

1.2 The bore holes shall be truly vertical and of uniform bore throughout specified depth. After boring to the required depth, the bore shall be cleared off the loose soil and disposal of surplus excavated stuff as directed within a lead of 50 m.

## 2.0 Mode of measurement and payment :

2.1 The rate for boring holes shall include.

(a) Roughly levelling the ground in positions where piles are to be provided.

(b) Making the position of piles by pegs and boring guide and also for shifting of boring guide.

(c) Bailing out water, if any, met with during boring.

(d) Disposal of surplus excavated soil within a lead of 50 m. and.

(e) All tools, plants, equipments and labour required for satisfactory completion of work.

2.2 The rate shall be for a unit of one R.mt.

Extra for under reaming inside the bore holes for under reamed piles of following nominal diameter (i) 200 mm (ii) 250 mm (iii) 300 mm

## 1.0 Workmanship :

1.1 The relevant specifications of Item No.4 shall be followed except that after boring to the required depth, the bore shall be enlarged at the bottom by an under reamer 2 to 2 1/2 times the diameter of the bore as directed. It shall be ensured that the bore for the pile shall be enlarged to the correct diameter.

## 2.0 Mode of measurements and payment :

2.1 The relevant specifications of Item No.90 shall be followed.

2.2 The rate shall be paid extra over and above the rate of Item No.4 for under remaining the piles.

2.3 The rate shall be for a unit of one R.mt..

**ITEM NO.91 :**

Providing & fixing U-PVC pipes Confirming to IS no. 13592 (Type "A") of Prince/Supreme/Jain/Astral/ Tulsi/Finolex make for rain water at all floor levels incl. fixtures like bends, tees, shoe etc joined with resin of approved brand & manufacture etc. comp. (M.R.)(a) 75 mm dia (b) 110 mm dia

## 1.0 MATERIALS :

The specified dia. P.V.C. spigot and socket soil or waste pipe shall conform M-68-A.

## 2.0 WORKMANSHIP :

2.1.0 The P.V.C. sprigot and Socket soil or waster pipe shall be joint as per following procedure.

2.1.1 Cut the P.V.C. pipe with a fine to the saw to the required lenth pipe should be cut square.

2.1.2 Chamfer the edge of the pipe to be inserted at an angle of about 15 to about 1/3 rd. the wall thickness, using a coarse file.

2.1.3 Make sure the spigot and socket are the roughly clean and dry.

2.1.4 Insert the pipe into the socket without the seal ring and mark along the pipe, when it is fully inserted.

2.1.5 Fix the rubber ring into the groove without twisting it.

2.1.6 Apply jointing lubricant to the chanfered end of the pipe, upto the make made on spigot or to the socket end of the fitting.

2.1.7 Push the pipe firmly into the socket till the gap between the mark on the sprigot and socket is about 10mm to allow for thermal expansion.

2.2.0 The pipe clips should be spaced at intervals of no more then ten times the outside diameter of pipes for horizontal runs & for vartical lines are spaced at intervals of one meter to a maximum of two moters according to pipe diameter.

2.3.0 All entry to main stacks should be protected with minimum 50mm water seal trap. Wherever there is mixing of soil & waste lines.

2.4.0 Smoke just should be avoided and test plug/ socket plug should be used for testing the lines.



- 2.5.0 All soil pipes shall be carried up above the roof and shall have a wire ballon guard or a cowl.
- 2.6.0 The vantilation pipe or shaft shall be carried out to a height of atleast one metre above the outer covering of the roof of the building or in the case of windows in a gable wall or a dormer two meters above the top of the windows. In case of flat roof to which access for use is provided, it shall be carried out upto a height of atleast one meter above the parapet or two meters measured vertically from the top of any windows or opening which may exist upto a horizontal distance of five meters from the vent pipe into such building and in no case shall be carried out to a height less than three meters.
- 2.7.0 Where ventilating pipes are carried in pipe shafts, the shafts, shall be of a minimum size of one meter. If the shafts are also used to give light and air to rooms, the ventilating pipes must be carried out to a horizontal distance at roof level not less than five meter from the site of the saft.
- 2.8.0 The connection between the main pipe and branch pipes shall be made by using branches and bends with access doors for cleaning.
- 2.9.0 The waste from lavatories, kitchens basins, sinks, baths and other floor traps shall be separatly connected to respective stacks of upper floors. The waste stack of lavatories shall be connected directly to main hole while the waste stack of other shall be separatly discharged over gully trap.
- 3.0 **MODE OF MEASUREMENTS & PAYMENT :**
- 3.1 The length of pipe shall be measured including all fittings along its length in running meters correct to a centimetre. No allowance shall be made for the portion of pipe length entered in the sockets of the adjacent pipe or fittings.
- 3.2 The rate includes all labour and materials, tool and plant etc. required for satisfactory completion of this item.
- 3.3 The rate shall be for a unit of one running meter.
- ITEM NO.91A :**  
Providing and fixing U-p.v.c. pipe (SWR) conforming to IS no. 13592 (Type "B") of Prince/Supreme/Jain make for soil and waste discharge system at all floor levels incl. All fixtures like bends, tees, shoe etc. jointed with resin of approved brand & manufacture etc. complete.(M.R.)
- (a) 75 mm dia (b) 110 mm dia
- 1.0 **MATERIALS :**  
The specified dia. P.V.C. spigot and socket soil or waste pipe shall conform M-68-A.
- 2.0 **WORKMANSHIP :**
- 2.1.0 The P.V.C. sprigot and Socket soil or waster pipe shall be joint as per following procedure.
- 2.1.1 Cut the P.V.C. pipe with a fine to the saw to the required lenth pipe should be cut square.
- 2.1.2 Chamfer the edge of the pipe to be inserted at an angle of about 15 to about 1/3 rd. the wall thickness, using a coarse file.
- 2.1.3 Make sure the spigot and socket are the roughly clean and dry.
- 2.1.4 Insert the pipe into the socket without the seal ring and mark along the pipe, when it is fully inserted.
- 2.1.5 Fix the rubber ring into the groove without rtwisting it.
- 2.1.6 Apply jointing lubricant to the chanfered end of the pipe, upto the make made on spigot or to the socket end of the fitting.
- 2.1.7 Push the pipe firmly into the socket till the gap between the mark on the sprigot and socket is about 10mm to allow for thermal expansion.
- 2.2.0 The pipe clips should be spaced at intervals of no more then ten times the outside diameter of pipes for horizontal runs & for vartical lines are spaced at intervals of one meter to a maximum of two moters according to pipe diameter.
- 2.3.0 All entry to main stacks should be protected with minimum 50mm water seal trap. Wherever there is mixing of soil & waste lines.
- 2.4.0 Smoke just should be avoided and test plug/ socket plug should be used for testing the lines.
- 2.5.0 All soil pipes shall be carried up above the roof and shall have a wire ballon guard or a cowl.
- 2.6.0 The vantilation pipe or shaft shall be carried out to a height of atleast one metre above the outer covering of the roof of the building or in the case of windows in a gable wall or a dormer two meters above the top of the windows. In case of flat roof to which access for use is provided, it shall be carried out upto a height of atleast one meter above the parapet or two meters measured vertically from the top of any windows or opening which may exist upto a horizontal distance of five meters from the vent pipe into such building and in no case shall be carried out to a height less than three meters.
- 2.7.0 Where ventilating pipes are carried in pipe shafts, the shafts, shall be of a minimum size of one meter. If the shafts are also used to give light and air to rooms, the ventilating pipes must be carried out to a horizontal distance at roof level not less than five meter from the site of the saft.
- 2.8.0 The connection between the main pipe and branch pipes shall be made by using branches and bends with access doors for cleaning.



- 2.9.0 The waste from lavatories, kitchens basins, sinks, baths and other floor traps shall be separately connected to respective stacks of upper floors. The waste stack of lavatories shall be connected directly to main hole while the waste stack of other shall be separately discharged over gully trap.
- 3.0 MODE OF MEASUREMENTS & PAYMENT :
- 3.1 The length of pipe shall be measured including all fittings along its length in running meters correct to a centimetre. No allowance shall be made for the portion of pipe length entered in the sockets of the adjacent pipe or fittings.
- 3.2 The rate includes all labour and materials, tool and plant etc. required for satisfactory completion of this item.
- 3.3 The rate shall be for a unit of one running meter.

**ITEM NO.92 :**

Providing erecting and fixing double coated Syntex or equivalent PVC (ISI) mark water tank of required capacity each with all necessary fittings & connection etc. complete on terrace.

**MATERIAL :**

The ready made water tank shall be of any approved manufacture like Sintex, fussion or equivalent quality product as approved by Engineer-in-charge.

**WORKMANSHIP :**

The water tank shall be approved and fixed as directed by Engineer-in-charge with all fitting and fixtures like over flow pipe, wash out pipe, inlet pipe etc. complete.

**MODE OF MEASUREMENT AND PAYMENT :**

The rate should cost of all materials labours, tools, plants etc. required to complete the item.

The rate shall be form unit of one litre excluding free brand.

**ITEM NO.93A:**

Providing & applying two coats of weather shield max paint (3 coats may be required in case of darker colours.)of ICI Dulux or Apex Ultima of Asian Paint including applying exterior acrylic primer coat as per manufacturers specification and directions in shade and colour approved by architects, on exterior surfaces of the building including scaffolding, preparing the surface, watering, curing etc. complete and as directed by the architects and manufacturers.

**Surface Preparation :**

surface is thoroughly clean, dry and free from all loose dirt, chalk, grease, fungi, algae and flaking paint. This can be achieved by brushing with a wire/ stiff coir brush, followed by water jetting if required. Fill up all minor cracks and defects with white cement and sand mixture in the ratio 1:3. For application on previously painted wall, previous coatings of paint must be thoroughly scraped off and Clean the surface thoroughly using wire brushes.

**Priming:**

Apply a liberal coat of exterior acrylic primer and allow it to dry for 4-5 hours. Application of putty is not recommended. Minimum 4-6 hours duration is required between each coat of weather shield max paint

Details specification same as per item description and as directed by Engineer-in-charge.

Measurement shall be paid on Sq.mt. basis.

**ITEM NO.93B:**

Distemping two coats with oil bound washable distemper of approved brand & manufacture & of required shade on wall surface to give an even shade over and & incl. a priming coat of alkali resistance primer of approved brand after thoroughly brushing the surface to give an even shade after thoroughly brushing the surface free from mortar droppings and other foreign matter and also including preparing the surface even and smooth for All floor level

(A) for wall and similar surfaces (B) for ceiling

Item is general shall be carried out as per the general specifications on page 413 and specification No.146 on Page 315 and 316 of P.W.D. H.B. Vol.I 1949 edition. Material shall also confirm to general specification of materials-M-34.

The surface were oil bound distemper is to be filled in creviess, depressions, pot-holes to make surface even and smooth. Lapi shall be allowed to dry and oil bound distemper of approved quality and shades then be applied with brush only. appropriate quality of water shall be added in paste.

Such coat of oil bound distemper shall be applied as directed. Patch work of difference in colour shades will not be tolerated, in such case extra one coat shall have to be applied for which to extra payment shall be made.

Measurement shall be paid on Sq.mt. basis.

**ITEM NO.94 :**



Providing and fixing factory made P.V.C. door frame of size 50 x 47 mm with all wall thickness of 5 mm made out of extruded 5 mm rigid P.V.C. foam sheet mitred at comers and joined with 2 Nos. of 150 mm long brackets of 15 x 15 mm M.S. square tube the vertical door profiles to be reinforced with 19 x 19 mm M.S. square tube of 19 gauge EPDM rubber gasket weather seal to be provided through out the frame. The door frame to be fixed to the wall using M.S. screws of 65/100 mm size complete as per manufacturers specification and direction of Engineer-in-charge (For W.C. and bathroom frame).

Details specification same as per item description and as directed by Engineer-in-charge.

**ITEM NO.95:**

Providing and fixing 30 mm thick factory made PVC rigid foam panelled door shutters (as per IS 4020) made from M.S. tube of 19 gauge thickness, size 19 x 19 mm for styles and 15 x 15 mm for top and bottom rails, covered with heat moulded PVC "C" channel of 5 mm thick sheet and 30 x 50 mm wide to form style and 5 mm thick and 75 mm wide PVC sheets for top rail, lock rail and bottom rail on either side and 6 mm thick, 20 mm wide cross PVC sheet as gap insert for top rail and bottom rail penelling of 5 mm thick PVC sheet fitted in the M.S. frame welded / sealed to the styles and rails with 5 x 30 mm PVC sheet breading on either side and joined together with solvent cement adhesive as per manufacturers specification and direction of Engineer-in-charge, fixed to frames with 4 Nos. M.S. powder coated but hinges including anodized aluminium fixtures and fastening etc. complete (For W.C. and bathroom shutter).

Details specification same as per item description and as directed by Engineer-in-charge.

**ITEM NO.95A :**

Providing and fixing FRP FRAME size 125 x 65 mm and 35 mm thick FRP shutter with wood grain raised paneled design finish shutter having extra reinforcement on sides & edges in Gel coat finish. The core of the shutter & frame is to be filled up with injected polyurethane foam done in situ along with embedded wooden pieces for stiffening & also taking hinges & fixtures. The whole FRP frame & shutter is to be water proof weather proof, termite proof & resistance to mild acid/alkali. Rates are to be inclusive of S.S.hinges with fastener sleeve & aluminium fixtures & fastenings. Product should have 3 years performance guarantee and company have ISO 9001-2000 certificate.

Details specification same as per item description and as directed by Engineer-in-charge.

**ITEM NO.96A :**

Providing & laying Vitrified tiles of 8mm to 10mm thick of Orient, Kajaria, Jhonson, Nitco, Somani, Bell, Asian or Euro make in flooring, treads of steps & Landing laid on bed of 20 mm (Average) base of cement mortar 1:6 (1 Cement : 6 Coarse sand) on new surface or fixing on existing flooring by adhesive material including dismantling of existing flooring and jointed with colour cement slurry including finished with flush pointing & cleaning the surface etc. comp. Size 36" x 36" (Basic Rate-Rs.842.0/S.M.)

Details specification same as per item No.46 but read Vitrified tiles instead of white glazed tiles and as directed by Engineer-in-charge.

The rate shall be for a unit of one Sq.metre.

**ITEM NO.96B :**

Providing and laying Vitrified tiles of 8mm to 10mm thick of Orient, Kajaria, Jhonson, Nitco, Somani, Bell, Asian or Euro make in skirting, risers of steps and dedo laid on 10mm thick cement mortar 1:4 (1 Cement : 4 Coarse sand) and finished with flush pointing in white or colour cement comp. Size 36" x 36"(Basic Rate: Rs.842.0/S.M.)

Details specification same as per item No.47 but read Vitrified tiles instead of white glazed tiles and as directed by Engineer-in-charge.

The rate shall be for a unit of one Sq.metre.

**ITEM NO.96C :**

Providing and laying ceramic tiles 8mm th. of Orient, Kajaria, Jhonson, Nitco, Somani, Bell, Asian or Euro make in flooring treads of steps and landing laid on bed of 20 mm thick cement mortar 1:6 (1 Cement : 6 Sand) finished with flush pointing in white cement.  
(Basic Rate:- Rs.360.0/S.M.)



Details specification same as per item No.46 but read ceramic tiles instead of white glazed tiles and as directed by Engineer-in-charge.

The rate shall be for a unit of one Sq.metre.

**ITEM NO.97A :**

Providing & laying granite slab 18mm thick in flooring, treads of steps and landing laid on bed of 20mm thick cement mortar 1:6 (1 Cement : 6 coarse sand) or lime mortar 1:1.5 laid and finished with flush pointing in white or colour cement including rubbing and polishing complete. (Basic Rate:- Rs.1614.0/S.M.)

Details specification same as per item No.44 but read granite slab instead of green polished kotah stone and as directed by Engineer-in-charge.

The rate shall be for a unit of one Sq.metre.

**ITEM NO.97B :**

Providing & laying granite slab 18mm thick in skirting, risers of steps, dedo and pillars laid on 10mm thick cement mortar 1:4 (1 Cement : 4 Coarse sand) and finished with flush pointing in white or colour cement including rubbing & polishing comp.. (Basic Rate:- Rs.1614.0/S.M.)

Details specification same as per item No.44 but read granite slab instead of green polished kotah stone and as directed by Engineer-in-charge.

The rate shall be for a unit of one Sq.metre.

**ITEM NO.98A :**

Providing and fixing extruded aluminium window having extruded aluminium Powder Coated section frame main outer size 127 mm x 38.10 mm x 1.35 mm (of Jindal section no:2443, @ Wt. 1.384Kg/mt) horizontal Four track member size 122.20 mm x 31.75 mm x 1.10 mm (of jindal section no:8935, @ Wt. 1.398 Kg/mt.) with sliding shutters of horizontal member size 40 mm x 18 mm x 1.29 mm ( of jindal section no:8949, @ Wt. of .456 Kg/mt) vertical member of size 40 mm x 18 mm x 1.29 mm (of jindal section no:8947, @ Wt. of 0.456 Kg/mt/section 8948, @ Wt. of 0.457 Kg/mt) with 5 mm thick transparent bronze colour tinted float glass with powder coated aluminium fittings and fixtures and transparent silicon sealant glass fixing to frame as per details etc. complete for window. (A) Same as above but Colour anodized

Matt anodized alluminium sliding windows shall be made of extruded alluminium sections having thickness not less than 1.5 mm and matt finished colour anodized not less than 20 micron.

The glass 5 mm thick float Saint/Gobain glass white or colour as directed.

At bottom drain section shall be used to drain out rain water. The draina track shall be three track 92 mm x 31.55 weighing not less than 1.070 Kg/mt. The and side track s shall not be weighing less than 0.933 Kg/meter and thickness shall not be less than 1.5 mm. The work shall be carried out as directed by Engineer-in-charge or consultants.

Shutter Frame Work :- The fully glazed shutter frame shall be made from top and bottom section weighing not less than 0.464 Kg/meter. having bearing of Durlin or Nylon 66. All the fixture, fastener bearing, locks, handle, gaskets shaoul be used after getting approved from Engineer-in-charge and architect. The handle section shall be weighing not less than 0.417 Kg/meter. The interlock section shall be weighing not less than 0.464 Kg/mt. and having thickness of 1.5 mm. The glass panel shall be fixed in frame work using EPDM gaskets.

The whole assembly of window shall be fixed in best workman like manner to have smooth operations. All the windows shall be sealed to the R.C.C. or brick work with silicon sealents of dow corning or Wacker Germany as approved by Engineer-in-charge or his consultant.

The rate shall be for a unit of one square metre.

**ITEM NO.98B :**





Providing and fixing extruded aluminium window having extruded aluminium Powder Coated section frame main outer size 127 mm x 38.10 mm x 1.35 mm (of Jindal section no:2443, @ Wt. 1.384Kg/mt) horizontal Four track member size 122.20 mm x 31.75 mm x 1.10 mm (of jindal section no:8935, @ Wt. 1.398 Kg/mt.) with sliding shutters of horizontal member size 40 mm x 18 mm x 1.29 mm ( of jindal section no:8949, @ Wt. of .456 Kg/mt) vertical member of size 40 mm x 18 mm x 1.29 mm (of jindal section no:8947, @ Wt. of 0.456 Kg/mt/section 8948, @ Wt. of 0.457 Kg/mt) with 5 mm thick transparent bronze colour tinted float glass with powder coated aluminium fittings and fixtures and transparent silicon sealant glass fixing to frame as per details etc. complete for window. (A) Same as above but Colour anodized

Details specification as per Item No.98A but read four track instead of Three track and as per drawing and as directed by engineer-in-charge.

**ITEM NO.98C:**

Providing and fixing standard extruded of aluminium section of size 61 x 37.0 x 0.90 mm (of Jindal section no.14080, @ Wt. 0.471 Kg per mt) with Powder Coated aluminium frame with 5 mm thick transparent bronze colour tinted float glass as details etc. complete for fix window.

Matt anodized aluminium sliding windows shall be made of extruded aluminium sections having thickness not less than 1.5 mm and matt finished colour anodized not less than 20 micron.

The glass 5 mm thick float Saint/Gobain glass white or colour as directed.

At bottom drain section shall be used to drain out rain water. The drain track shall be three track 92 mm x 31.55 weighing not less than 1.070 Kg/mt. The and side tracks shall not be weighing less than 0.933 Kg/meter and thickness shall not be less than 1.5 mm. The work shall be carried out as directed by Engineer-in-charge or consultants.

Shutter Frame Work :- The fully glazed shutter frame shall be made from top and bottom section weighing not less than 0.464 Kg/meter. having bearing of Durlin or Nylon 66. All the fixture, fastener bearing, locks, handle, gaskets shall be used after getting approved from Engineer-in-charge and architect. The handle section shall be weighing not less than 0.417 Kg/meter. The interlock section shall be weighing not less than 0.464 Kg/mt. and having thickness of 1.5 mm. The glass panel shall be fixed in frame work using EPDM gaskets.

The whole assembly of window shall be fixed in best workman like manner to have smooth operations. All the windows shall be sealed to the R.C.C. or brick work with silicon sealants of dow corning or Wacker Germany as approved by Engineer-in-charge or his consultant.

The rate shall be for a unit of one square metre.

**ITEM NO.98D:**

Providing and fixing window having extruded Aluminium colour Powder Coated Section Frame main Outer Size 63.5mm x 38.1mm x 1.95mm (of Jindal Section No. 4605 @ Wt. of 1.094 Kg./Mt.) Horizontal Two track member size 61.85mm x 31.75mm x 1.20mm (of Jindal Section No. 8687, @ Wt. 0.695Kg./Mt.) Vertical Member of size 61.85mm x 31.75mm x 1.30mm (of Jindal Section No. 8758, @ Wt. 0.659 Kg./Mt.) with sliding shutters of Horizontal member size 40mm x 18mm x 1.29mm (of Jindal Section No. 8947 @ Wt. of 0.456 Kg./Mt.) Vertical Member of size 40mm x 15mm x 1.29mm (of Jindal Section No. 8948 @ Wt. of 0.457 Kg./Mt.) with 5mm thick transparent bronze colour tinted float glass with powder coated Aluminium fittings & fixtures & transparent silicon sealant glass fixing to frame as per detail etc. complete.

Matt anodized aluminium sliding windows shall be made of extruded aluminium sections having thickness not less than 1.5 mm and matt finished colour anodized not less than 20 micron.

The glass 5 mm thick float Saint/Gobain glass white or colour as directed.

At bottom drain section shall be used to drain out rain water. The drain track shall be three track 92 mm x 31.55 weighing not less than 1.070 Kg/mt. The and side tracks shall not be weighing less than 0.933 Kg/meter and thickness shall not be less than 1.5 mm. The work shall be carried out as directed by Engineer-in-charge or consultants.

Shutter Frame Work :- The fully glazed shutter frame shall be made from top and bottom section weighing not less than 0.464 Kg/meter. having bearing of Durlin or Nylon 66. All the fixture, fastener bearing, locks, handle, gaskets shall be used after getting approved from Engineer-in-charge and architect. The handle section shall be weighing not less than 0.417 Kg/meter. The interlock section shall be weighing not less than 0.464 Kg/mt. and having thickness of 1.5 mm. The glass panel shall be fixed in frame work using EPDM gaskets.

The whole assembly of window shall be fixed in best workman like manner to have smooth operations. All the windows shall be sealed to the R.C.C. or brick work with silicon sealants of dow corning or Wacker Germany as approved by Engineer-in-charge or his consultant.

The rate shall be for a unit of one square metre.

**ITEM NO.98E:**

Providing and fixing window having extruded Aluminium colour Powder Coated Section Frame main Outer Size 95mm x 24mm x 1.17mm (of Jindal Section No. 2459 @ Wt. of 0.738 Kg./Mt.) Horizontal Three track member size 92mm x 31.75mm x 1.30mm (of Jindal Section No. 8688, @ Wt. 1.07Kg./Mt.) Vertical Member of size 92mm



x 31.75mm x 1.50mm (of Jindal Section No. 8933, @ Wt. 1.06 Kg./Mt.) with sliding shutters of Horizontal member size 40mm x 18mm x 1.29mm(of Jindal Section No. 8947 @ Wt. of 0.456 Kg./Mt.) Vertical Member of size 40mm x 15mm x 1.29mm (of Jindal Section No. 8949 @ Wt. of 0.456 Kg./Mt.) with 5mm thick transparent bronze colour tinted float glass with powder coated Aluminium fittings & fixtures & transparent silicon sealant glass fixing to frame as per detail etc. complete.

Matt anodized aluminium sliding windows shall be made of extruded aluminium sections having thickness not less than 1.5 mm and matt finished colour anodized not less than 20 micron.

The glass 5 mm thick float Saint/Gobain glass white or colour as directed.

At bottom drain section shall be used to drain out rain water. The drain track shall be three track 92 mm x 31.55 weighing not less than 1.070 Kg/mt. The end and side tracks shall not be weighing less than 0.933 Kg/meter and thickness shall not be less than 1.5 mm. The work shall be carried out as directed by Engineer-in-charge or consultants.

Shutter Frame Work :- The fully glazed shutter frame shall be made from top and bottom section weighing not less than 0.464 Kg/meter. having bearing of Durlin or Nylon 66. All the fixture, fastener bearing, locks, handle, gaskets shall be used after getting approved from Engineer-in-charge and architect. The handle section shall be weighing not less than 0.417 Kg/meter. The interlock section shall be weighing not less than 0.464 Kg/mt. and having thickness of 1.5 mm. The glass panel shall be fixed in frame work using EPDM gaskets.

The whole assembly of window shall be fixed in best workman like manner to have smooth operations. All the windows shall be sealed to the R.C.C. or brick work with silicon sealants of Dow Corning or Wacker Germany as approved by Engineer-in-charge or his consultant.

The rate shall be for a unit of one square metre.

#### **ITEM NO.99:**

Steel work welded in built up sections, framed work including cutting, hoisting, fixing in position and applying a priming coat of red lead paint (A) in beams & joists channels angles, tees, flats with connection plates or angle cleats as in main & cross beams, hip & trussed purlins connected to common rafters & the like.

#### **LAYING OUT :**

The steel structures, as shown in the drawings or as per directions of the Engineer-in-charge, shall be laid out on a level platform to full scale and to full size in parts. A steel type shall be used for measurements to ensure maximum accuracy.

Wooden templates 12 mm to 19 mm thick or steel templates shall be made to correspond to each connecting gusset plate and rivet holes shall be accurately marked on them and drilled. The templates shall be laid on the steel members and holes for rivetting and bolting marked on them. The ends of the steel members shall also be marked for cutting. The base of steel columns and the position of anchor bolts shall be carefully set out.

#### **FABRICATION :**

The steel sections as specified shall be straightened and cut square and accurately to correct lengths. The cut ends exposed to view shall be finished smooth. No. two pieces shall be welded or otherwise jointed to make up required length of a member except as indicated in the drawing or otherwise specifically permitted by the Engineer-in-charge. All straightening and shaping to form shall be done by application of pressure and not by hammering. Any bending or cutting shall be carried out in cold condition (unless otherwise directed) in such a manner as not to impair the strength of the metal.

All stiffeners shall be formed by pressure, and where practicable, the metal shall not be cut and welded in making these. In major works or where so specified, shop drawings giving complete details and information for the fabrication of the component parts of the structure, including the locating, type, size, length and details of rivets, bolts or welds shall be prepared in advance of the actual fabrication and approved by the Engineer-in-charge. The drawing shall indicate the shop and filed rivets, bolts and welds. The steel members shall be distinctly marked or stencilled with paint with the identification marks as given in the shop drawings.

The bars shall be thickened at the ends so as to provide for screwed threads and gradually tapered off to meet their normal section.

Great accuracy shall be observed in the fabrication of various members. Do that these can be assembled without being unduly packed strained or forced into position and when built-up shall be true and free from twists, bricks buckles or open joints.

Before making holes in individual members, for fabrication the steel work intended to be riveted or bolted to gather shall be assembled or clamped properly and tightly so as to ensure close abutting or lapping of the surface of the different



members. All stiffeners shall be tightly both at top and bottom without being drawn or caulled. The abutting joints shall be cut of dressed true and straight and fitted close together,

We splice plates and fillers under stiffeners shall be cut to fit within 3 mm of flange angles. We plated or girders which have no cover plates shall have their ends flush with the top of angles forming the flanges unless otherwise required. The we plates, when spliced shall have clearance of not more than 6 mm.

The erection clearance for cleated ends of members connecting steel to steel preferably be not greater than 1.5 mm. The erection clearance at the ends of beams without web cleats shall not be more than 3 mm. at each end but where for practical reasons, greater clearance is necessary, suitably designed seating shall be provided.

Pins and rollers shall be accurately turned to gauge. These shall be straight and smooth and free from flaws. The roller bearing shall be provided with adequate arrangement for holding the girders or truss resting on it, from lateral displacement.

Expansion bed plates shall be planed true and smooth. The planning of bed plates shall be done in the direction of the movement of the girder or truss resting on it.

Column splices and but joints of struts and impression members depending on contract for trees transmission shall be accurately machined and closebutted over the whole section. In column caps and bases, the ends of shafts together with the attached gussets, angles, channels etc. after riveting together shall be accurately machinised so that the parts connected but against each other over the entire surface of contract. Connecting angles or channels shall be fabricated and placed in position with great accuracy so that they are not unduly reduced in thickness by machining.

The ends of all bearing stiffeners shall be machined or ground to fit tightly both at the top and bottom.

All holes shall generally be drilled to the required size and at the required position. Sub-punching shall be permitted, provided it is done 3 mm. less in diameter and reamed thereafter to the required size.

Holes for rivets and black bolts shall be large by 0.4 to 6 mm. as shown in appendix-I under column "Coarse" than the nominal diameter of the rivets or black bolts depending upon the dia of rivets. Holes for turned and fitted bolts shall be drilled or reamed large by 0.2 to 3 mm. depending upon the dia of bolts as shown in Appendix under column "Medium".

When the number of plates or sections to be riveted together exceeds three or when their total thickness is 90 mm or more, holes shall be drilled or reamed in position, after the members are assembled and the parts firmly hold together by clamps. Before riveting or bolting up or welding finally. The members shall be taken part and all burrs removed.

Holes shall have their axis perpendicular to the surface bore through. The drilling or reaming shall be free from burrs and the holes shall be clean and accurate.

The work or fabrication shall be completed in the work shop as far as it is practicable to do so. Site jointing shall be done with rivets or turned and fitted bolts, or black bolts or welding as shown in drawings or as directed by the Engineer-in-charge. Generally, the following principles shall govern the use of rivets, turned and fitted bolts and black bolts :-

- [ i ] Rivets or turned and fitted bolts shall be used where the connection is such that slip under load has or be avoided.
- [ii] Black bolts may be used very sparingly where a force is carried through a connecting without impact, vibration or reversal of stresses (unless such reversal is due to wind forces.)

In the case of welding, holes shall only be made for the bolts used for temporary fastening as shown in drawings.

#### WELDING :

Welding shall be generally be done by electric process. The electric arc method being economical, is usually adopted. Where public electricity is not available, a suitable generator shall be arranged. Gas welding shall be resorted to using oxyacetylene flame with specific period approval of the Engineer-in-charge.

Gas welding shall not be permitted for structural steel work. Gas welding required heating of the members to be welded along with the welding rod and is likely to create temperature stresses in the welded members. Precautions shall therefore be taken to avoid distortion of the members due to these temperature stresses.

The work shall be done as shown in the shop drawings which should clearly indicate various details of the joints to be welded, type of welds, shop and site welds, as well as the types of electrodes to be used symbol for welding on plans and shop drawings shall be according to IS : 813-1061. As far as possible, every effort shall be made to limit the welding that must be done after the structure is erected so as to avoid the improper welding that is likely to be done due to heights and difficult positions of scaffolding etc. a part from the aspect of economy.

#### PREPARATION OF SURFACE :



Surfaces which are to be welded together, shall be free from loose mild-scale, rust, paint, grease or other foreign matter. A Coating of boiled linseed oil shall be permitted.

**PRECAUTIONS :**

All operations connected with welding and cutting equipment shall conform to the safety requirement given in IS : 818-1968 for "Safety and Health requirements in Electric and Gas welding and Cutting Operations".

The following points shall be borne in mind during the process of welding :-

- [a] Welds shall be made in the flat position. Wherever practicable.
- [b] Arc length, voltage and amperage shall be suited to the thickness of materials, type of groove and other circumstance of the work.
- [c] The sequence of welding shall be such that where possible, the members which offer the greatest resistance to compression are welded first.

All defective welds which shall be considered, harmful to the structural strength shall be cut out and rewelded.

Finished welds and adjacent parts shall be protected with clean boiled linseed oil and after all slag has been removed. Welds and adjacent parts shall be painted after the same are approved by the Engineer-in-charge.

All the members shall be thoroughly cleaned of rust, scales dust etc. and given a priming coat of lead painting before fixing them in position.

**RATE :**

Item shall be paid in Kg. basis.

**ITEM NO.100:**

Providing & laying Granular Sub Base conforming to Grading II of Table 400.2 of compacted thickness of 150 mm with specified graded stone metal and sand mixed in place and laid with mechanical means spreading with motor grader and compacting with vibratory roller having minimum 80-100 KN static weight to achieve desired density of 98 % of MDD including all material, labour, machinery with all leads and lifts etc. comp.

**3.1.0 SCOPE:**

The work shall consist of laying and compacting well-graded material on prepared subgrade in accordance with the requirements of these Specifications. The material shall be laid in one or more layers as sub-base or lower sub-base and upper sub-base (termed as sub-base hereinafter) as necessary according to lines, grades and cross-sections shown on the drawings or as directed by Engineer-in-charge.

**3.2.0 MATERIALS:**

**3.2.1** The material to be used for the work shall be natural sand, murrum, gravel, crushed stone, or combination thereof depending upon the grading required. Materials like crushed slag, crushed concrete, brick metal and kankar may be allowed only with the specific approval of the Engineer. The material shall be free from organic or other deleterious constituents and conform to one of the three gradings given in Table 400-1.

While the gradings in Table 400-1 are in respect of close-graded granular sub-base materials, one each for maximum particle size of 75 mm, 53 mm and 26.5 mm, the corresponding gradings for the coarse graded materials for each of the three maximum particle sizes are given at Table 400-2. The grading to be adopted for a project shall be as specified in the Contract.

**3.2.2** Physical requirements: The material shall have a 10 percent fines value of 50 kN or more (for sample in soaked condition) when tested in compliance with BS:812 (Part-III). The water absorption value of the coarse aggregate shall be determined as per IS:2386 (Part-3); if this value is greater than 2 percent, the soundness test shall be carried out on the material delivered to site as per IS:383. For Grading-II and III materials, the CBR shall be determined at the density and moisture content likely to be developed in equilibrium conditions which shall be taken as being the density relating to a uniform air voids content of 5 percent.

**TABLE 400-1 GRADING FOR CLOSE GRADED GRANULAR SUB-BASE MATERIALS**

US. Sieve Designation Grading-I	Percent by weight passing the IS sieve		
	Grading-I	Grading-II	Grading-III
75.0 mm	100	--	--
53.0 mm	80-100	100	--
26.5 mm	55-90	70-100	100
9.50 mm	35-65	50-80	65-95
4.75 mm	25-55	40-65	50-80
2.36 mm	20-40	30-50	40-65
0.425 mm	10-25	15-25	20-35



0.075 mm	3-10	3-10	3-10
CBR Value (Minimum)	30	25	20

TABLE 400-2 GRADING FOR COARSE GRADED GRANULAR SUB-BASE MATERIALS

US. Sieve Designation Grading-I	Percent by weight passing the IS sieve		
	Grading-I	Grading-II	Grading-III
75.0 mm	100	--	--
53.0 mm	--	100	--
26.5 mm	55-75	50-80	100
9.50 mm			
4.75 mm	10-30	15-30	25-45
2.36 mm			
0.425 mm			
0.075 mm	<10	<10	<10
CBR Value (Minimum)	30	25	20

Note:- The material passing 425 micron (0.425 mm) sieve for all the three gradings when tested according to IS:2720 (Part-5) shall have liquid limit and plasticity index not more than 25 and 6 percent respectively.

### 3.3.0 STRENGTH OF SUB-BASE:

It shall be ensured prior to actual execution that the material to be used in the sub-base satisfies the requirements of CBR and other physical requirements when compacted and finished.

When directed by the Engineer, this shall be verified by performing CBR tests in the laboratory as required on specimens remoulded at field dry density and moisture content and any other tests for the "quality" of materials, as may be necessary.

### 3.4.0 CONSTRUCTION OPERATIONS:

3.4.1 Preparation of subgrade: Immediately prior to the laying of sub-base, the subgrade already finished to Clause 301 or 305 as applicable shall be prepared by removing all vegetation and other extraneous matter, lightly sprinkled with water if necessary and rolled with two passes of 80-100 kN smooth wheeled roller.

3.4.2 Spreading and compacting: The sub-base material of grading specified in the Contract shall be spread on the prepared subgrade with the help of a motor grader of adequate capacity, its blade having hydraulic controls suitable for initial adjustment and for maintaining the required slope and grade during the operation or other means approved by the Engineer-in-charge.

When the sub-base material consists of combination of materials mentioned in Clause 401.2.1, mixing shall be done mechanically by the mix-in-place method.

Manual mixing shall be permitted only where the width of laying is not adequate for mechanical operations, as in small sized jobs. The equipment used for mix-in-place construction shall be a rotavator or similar approved equipment capable of mixing the material to the desired degree. If so desired by the Engineer, trial runs with the equipment shall be carried out to establish its suitability for the work.

Moisture content of the loose material shall be checked in accordance with IS:2720 (Part-2) and suitably adjusted by sprinkling additional water from a truck mounted or trailer mounted water tank and suitable for applying water uniformly and at controlled quantities to variable widths of surface or other means approved by the Engineer so that at the time of compaction, it is from 1 percent above to 2 percent below the adding water, due allowance shall be made for evaporation losses. After water has been added, the material shall be processed by mechanical or other approved means like disc harrows, rotavators until the layer is uniformly wet.

Immediately thereafter, rolling shall start. If the thickness of the compacted layer does not exceed 100 mm, a smooth wheeled roller of 80 to 100 kN weight may be used. For a compacted single layer upto 225 mm the compaction shall be done with the help of a vibratory roller of minimum 80 to 100 kN static weight with plain drum or pad foot-drum of heavy pneumatic tyred roller of minimum 200 to 300 kN weight having a minimum tyre pressure of 0.7 MN/Sq.m. or equivalent capacity roller capable of achieving the required compaction. Rolling shall commence at the lower edge and proceed towards the upper edge longitudinally for portions having unidirectional crossfall and super-elevation and shall commence at the edge and progress towards the centre for portions having crossfall on the both sides.

Each pass of the roller shall uniformly overlap not less than one third of the track made in the preceding pass. During rolling, the grade and crossfall (camber) shall be checked and any high spots or depressions, which become apparent, corrected by removing or adding fresh material. The speed of the roller shall not exceed 5 km per hour.

Rolling shall be continued till the density achieved is at least 98 percent of the maximum dry density for the material determined as per IS:2720 (Part-8). The surface of any layer of material on completion of compaction shall be well closed, free from movement under compaction equipment and from compaction planes, ridges, cracks or loose material. All loose, segregated or otherwise defective means shall be made good to the full thickness of layer and re-compacted.

### 3.5.0 SURFACE FINISH AND QUALITY CONTROL OF WORK:





The surface finish of construction shall conform to the requirements of clause-902.

Control on the quality of materials and works shall be exercised by the Engineer in accordance with section 900.

3.6.0 ARRANGEMENTS FOR TRAFFIC:

During the period of construction arrangement of traffic shall be maintained in accordance with Clause-112.

3.7.0 MEASUREMENTS FOR PAYMENT:

Granular sub-base shall be measured as finished work in position in cubic metres.

The protection of edges of granular sub-base extended over the full formation as shown in the drawing shall be considered incidental to the work of providing granular sub-base and as such no extra payment shall be made for the same.

3.8.0 RATE:

The contract unit rate for granular sub-base shall be payment in full for carrying out the required operations including full compensation for:

- (i) making arrangements for traffic to Clause-112 except for initial treatment to verges, shoulders and construction of diversions;
- (ii) furnishing all materials to be incorporated in the work including all royalties, fees, rents where necessary and all leads and lifts;
- (iii) all labour, tools, equipments and incidentals to complete the work to the specifications;
- (iv) carrying out the work in part widths of road where directed; and
- (v) carrying out the required tests for quality control.

**ITEM NO.100A:**

Preparation of subgrade with compacting, Leveling and consolidation of subgrade with miniroller/plate vibrator machine including watering and filling in depression occur the process as directed by engineer in charge.

Immediately following the spreading of the subgrade material rolling shall be started with mini roller/plate vibrator machine.

Except on superlevated portion where the rolling shall proceed from inner edge to outer, rolling, shall be from the edges gradually progressing towards the centre. First the edge/edges shall be compacted with roller running forward and backward. The roller shall then move inwards parallel to the centre line of the road, in successive passes uniformly lapping preceding tracks by at least one half way width.

Rolling shall continue until the subgrade material is thoroughly keyed and the creeping of the sub-grade ahead of the roller is no longer visible. During the process rolling shall not be done when the sub grade is soft or yielding or when it causes a wave like motion in the sub-grade course.

The rolled surface shall be checked transversely and longitudinally with templates and any irregularities corrected by loosening the surface, adding or removing necessary amounts of subgrade material and rerolling until, the entire surface conforms to desired camber and grade. In no case shall use of screening be permitted to make up depressions.

The binding materials where it is required to be used shall be applied, successively in two or more thin layers at a slow and uniform rate. After each application, the surface shall be continuously sprinkled with water, the resulting slurry swept in with hand brooms or mechanical brooms to fill the voids properly, and rolled during which water shall be applied to the wheels of the rollers if necessary to wash down the binding materials sticking to them. These operations shall continue until the resulting slurry after filling of voids, forms a wave ahead of the wheels of the moving roller. After the final compaction of subgrade course the road shall be allowed to dry overnight. Next morning hungry spot shall be filled with screening of binding materials as directed, lightly sprinkled with water, if necessary and rolled. No traffic shall be allowed on the road until the base has set. The Engineer-in-charge shall have the discretion to stop hauling traffic from using the completed subgrade course if in his opinion it would cause excessive damage to the surface.

**MODE OF PAYMENT :-**

Payment will be made on Sq.mt. basis consolidation of finished work and shall also include cost of watering, rent of machinery, cost of fuel, wages of drivers and cleaners, earthen and murrum bund etc. and watchman etc.

**ITEM NO.100B :-**

Box Cutting the road surface to proper slope and camber for making base including removing the excavated stuff and depositing on the road side slope as directed up to 50 mt. lead.



## DESCRIPTION :-

The land width required for the roadway, gutters side slopes and catch water gutters shall be cleared of all trees having a girth of 30 cm. and less, loose stones, vegetation bushes, stumps and all other objectionable materials. The roots of trees and stumps shall be removed to a depth of 30 cms. below the grade formation and slopes and excavation filled up with excavated materials and loose. Useful materials shall be arranged in convenient stacks along the roads boundary or as directed at places within 50 metres lead, and handed over to the department in convenient sections. Unsuitable materials shall be burnt or otherwise disposed off by the contractor at his own cost without causing any nuisance, inconvenience or damage to the works, property or people in the neighborhood. If the materials disposed off outside the road land, necessary permission from the private land owners shall be taken by the contractor and royalty etc. if any paid by him without claiming any compensation. All materials shall be disposed off in a neat manner.

After cleaning the site, the alignment of the road shall be properly set out true to line, curves, slopes, grade and sections as shown on the plans or directed by the Engineer-in-charge. The Contractor shall provide all labour and materials such as lime, strings, pegs, nails, bamboos, stones, mortar, concrete etc. required for setting out establishing bench marks and giving profiles. The Contractor shall be responsible for maintaining the B.Ms. profiles, alignments and other marks as long as they are required for the work in the opinion of the Engineer-in-charge. If the Contractor defaults in the respect even after the direction by the Engineer-in-charge within the specified time, they may be restored by the Engineer-in-charge at the cost of Contractor. Levels and section of the ground shall be taken and recorded in the presence of the Contractor or his authorised representative before the excavation is started so as to serve as the basis of measurement. The Contractor or his representative shall sign the book in token of his acceptance of the level etc. If there is any disagreement the Contractor shall inform of it in writing to the Engineer-in-charge with the specified reference to the sections before starting further work. Once the work is started no cognizance of any complaint shall be taken merely not signing of the book shall not be deemed as disagreement.

Profiles of the section including the road side gutters to be excavated shall be laid at suitable intervals of 10 m to 50 m or other intervals as directed by the Engineer-in-charge to conform to the curved or straight alignment, section, grade and side slopes. The lineouts shall be clearly marked and profiles of embankments where excavated materials are to be used shall be set up with the toe line marked on each side. The road way section shall first be excavated with vertical side for each lift and the sides slopes for that lift shall be excavated in steps. These steps shall be smoothed to the required slope when the excavation reaches the road formation. The contractor shall on no account excavate beyond the slopes or below the specific grade unless so directed by the Engineer in writing. If excavation is done below the specified level or outside the section, it shall not be paid for and the contractor shall be required to fill up at his own cost such extra excavation in the road portion, with approved materials of the embankment grade in layer watered and fully loose to attain maximum density laid down for the embankment in its relevant item. The Engineer may require measurement ridges and deadmen to be left at specified intervals or places and kept in tact till ordered to be removed, for the purposes of check measurements. The excavation shall be finished neatly, smoothly and evenly to the correct lines, curves, grades, section and side slopes as shown on the plans or directed by the Engineer-in-charge. The sub-grade if loose, shall be scarified, watered and loose to the same density as the embankment. The section, side slopes and catch water gutter shall be maintained by the contractor at his own cost in such a way that the formation and gutters will be well drained by providing necessary diversion etc. and not damaged due to obstruction of any drainage, necessary passages shall be provided for leading away seepage, springs, surface flow or rainwater safely without damaging the work. If any damage occurs due to default of the contractor in this respect, he shall make good the damage at his cost. If it is necessary in the execution of the work to interrupt existing surface drainage, irrigation channels, sewers or under drainage, temporary arrangements shall be provided till such time as is necessary. The Contractor at his own cost shall make good the interrupted drainage and sewer etc. unless separately provided in the tender. Any damage to the existing works or work in hand caused as a result of his operations or negligence shall be made good by the Contractor at his own cost. Road side gutters shall be excavated to the specified section and shall be measured along with the main cutting in cubic metres.

If slides occur in the cutting they shall be removed as ordered by the Engineer-in-charge. If finished slopes slide in to the road way before the final acceptance of the work, such slides shall be removed by the Contractor and shall be paid for at the contract rate for the class of excavation involved provided the slides are not due to any negligence of the Contractor. The classification of the material in slides shall conform to its condition at the time of removal and payment made accordingly regardless of its time of prior conditions. Care shall be taken to see that excavation is arranged in a safe way so that there will be no risk to the work or workman by slides, falling materials, boulders and collapsing slides.

If there is traffic nearby or if there are towns village in the neighborhood barricades and/or traffic signal shall be provided day and night for the duration of the work in such a way as to prevent accidents. Warning signals shall be displayed at 7 mt. from the danger point on both sides to give sufficient warning. If necessary, signalers shall be stationed at each end to regulate traffic where it is heavy. Measures shall be taken to see that the excavation does not affect or damage adjoining structures or property. If there is damage to property, injury to workers, the members of the public,



animals etc. due to the negligence of the Contractor, he will be responsible and liable to all the consequence including compensation.

When the useful excavated materials is to be used in embankment within a lead 50 metre and all lift, it shall be directly deposited at the required location in specified layers. No handling or conveyance charges shall be paid if the materials is temporarily deposited elsewhere and subsequently conveyed to site of deposition. The sequence of operations should be arranged properly, Materials required for items other than bank shall be arranged in neat stacks at convenient places, without interfering with drainage in any way. The excavated materials shall not be deposited within 3 m from the top edge of slope or top of the bank. The lead shall be measured from the junction point of cutting and embankment up to 50 mt. on either side. The contract rate shall be for a unit of one cubic metre for the stratus mentioned in the wording of the item of excavation acceptably completed, as directed by the Engineer-in-charge.

#### DISPOSAL OF EXCAVATED MATERIALS :-

All the surplus excavated materials shall be the property of the contractor. Suitable material obtained from the excavation of the roadway shoulders, verge, drains, cross drainage works etc. shall be used for

- i) Filling for roadway embankments
- ii) Filling existing pits in the right of way as directed by the Engineer including levelling and spreading with all leads and lifts.
- iii) For landscaping of the road as directed by the Engineer, including levelling and spreading, with all leads and lifts.
- iv) Surplus material such as rubble, stones etc. not intended for use as above shall be used as a raw material for crusher with prior permission of Engineer-in-charge.

Unsuitable and surplus material which in the opinion of the Engineer cannot be used in the works shall be removed from site by the Contractor and disposed off including all lead & lifts. No place will be made available by the employer for disposing off the material and no claim will be entertained on that account.

#### 1.1 MEASUREMENTS FOR PAYMENT

Excavation for roadway shall be measured by taking crosssections at suitable intervals in the original position before the work starts and after its completion and computing the volumes in cu. m. by the method of average end areas for each class of material encountered. At the option of the Engineer, the Contractor shall leave depth indicators during excavations of such shape and size and in such positions as directed so as to indicate the original ground level as accurately as possible. The contractor shall see that these remain intact till the final measurements are taken.

#### 1.2. RATES :-

The contract unit rates for the items of roadway and drain excavation shall be payment in full for carrying out the operations required for the individual items including full compensation for :

- (i) Setting out
- (ii) Transporting the excavated materials and depositing the same on sites of embankments, spoil banks or stacking as directed within lifts and lead upto 50 m.
- (iii) Trimming bottoms and slopes of excavation.
- (iv) Dewatering
- (v) Desposal of surplus excavated stuff and clearing of site after completion of work.
- (vii) Watering where necessary and compacting to requirements.
- (viii) Erecting all safety provisions and making necessary diversions as directed by Executive Engineer/Engineer-in-charge.

#### ITEM NO.101:



Supplying & filling fine sand (pana) in 150 mm compacted thickness over the nbase including necessary compaction, watering etc. compacted. Item includes levelling byusing vibratory plates compacted machine and as directed by engineer in charge.

5.1.0 MATERIALS :

5.1.1 Fine sand (Pana) shall conform to specification of material M-3.

5.2 WORKMANSHIP :

5.2.1 Fine sand (Pana) shall be supplied to worksite and staked at suitable place. It shall be got approved by Engineer-in-charge. Fine sand (Pana) shall be filled in compacted thickness of 150 mm. It shall be compacted and watered thoroughly.

**ITEM NO.102:**

Providing interlocking type Rubber moulding cement concrete Paver Block of approved shape, design & colour having 60 mm thickness (M-35) Purchased from S.M.C's approved paverblock manufactures only & fixing on fine sand bedding. Item includes leveling by using vibratory plates compacted machine. Item also includes all materials, labour, equipments, tools, plants, watering, cleaning etc. Complete

With colour

Without colour

7.1 RAW MATERIAL

7.1.1 CEMENT:-

The cement used in the manufacture of high quality precast concrete paving block shall be conforming to IS 12269 (53 grade) ordinary Portland Cement or IS 8112 (43 grade ordinary Portland cement). The minimum cement content in concrete used for making paver blocks should be 310 kg/Cu.M. And the upper limit of cement shall not be more than 425kg/Cu.M.

7.1.2 AGGREGATES :-

The fine and coarse aggregates shall consist of naturally occurring crushed or uncrushed materials which, apart from the grading requirements comply with IS 383-1970. The fine aggregates used shall contain a minimum of 25% natural silicon sand. Lime stone aggregates shall not be used. Aggregates shall contain no more than 3% by weight of clay and shall be free from deleterious salts and contaminants.

7.1.3 WATER :-

The water shall be clean and free from any deleterious matter. It shall meet the requirements stipulated in IS:456-2000.

7.1.4 OTHER MATERIALS :-

Any other material/ingredients used in the concrete shall conform to latest IS specifications.

7.2 PAVER BLOCKS CHARACTERISTICS

The concrete pavers should have perpendicularities after release from the mould and the same should be retained until the laying.

The surface should be of anti-skid and anti glare type. The paver should have uniform chamfers to facilitate easy drainage of surface run off.

The pavers should have uniform interlocking space of 2 mm to 3 mm to ensure compacted sand filling after vibration on the paver surface.

The concrete mix design should be followed for each batch of materials separately and automatic batching plant is to be used to achieve uniformity in strength and quality.

The pavers shall be manufactured in single layer only.

Skilled labour should be employed for laying blocks to ensure line and level for laying, desired shape of the surface and adequate compaction of the sand in the joints.

The pavers are to be skirted all round with kerbing using solid concrete blocks of size 100 mm x 200 mm x 400 mm or as directed by the Engineer. The kerbing should be embedded for 100 mm depth. The concrete used for kerbing shall be cured properly for 7 days minimum.

7.3 LAYING OF PAVER BLOCKS :-

7.3.1 PRIMING :-

It will be responsibilities of the Contractors to ensure that the manhole/pipeline cable trenches/circular drainage system etc. raised to driveway level using the requisite materials as per instruction of Engg. The areas of potholes/deep depressions at the isolated locations also have to be filled up before laying the paver blocks. No extra payments will be made for this purpose.

It will be the responsibility of the Contractors to ensure that undulations on the paver blocks are eliminated after the traffic is allowed on it. Proper slope for drainage of water needs to be ensured by the Contractor. All necessary materials, tools, tackles are required to be arranged by the Contractor.

**7.3.2 BEDDING SAND COURSE :-**

The bedding sand shall consist of a clean well graded sand passing through 4.75 mm sieve and suitable for concrete. The bedding should be from either a single source or blended to achieve the following grading.

In Sieve Size	% Passed
9.52 mm	100
4.75 mm	95-100
2.36	80-100
1.18	60-100
600 Microns	25-60
300 Microns	10-30
150 Microns	5-15
75 Microns	0-10

Contractor shall be responsible to ensure that single-sized, gap graded sands or sands containing an excessive amount of fines or plastic fines are not used. The sand particles should preferably be sharp not rounded as sharp sand possess higher strength and resist the migration of sand from under the block to less frequently areas even though sharp sands are relatively more difficult to compact than rounded sands, the use of sharp sands is preferred for the more heavily trafficked driveways. The sand use for bedding shall be free of any deleterious soluble salts or other contaminants likely to cause efflorescence.

The sand shall be of uniform moisture content and within 4%-8% when spread and shall be protected against rain when stock piled prior to spreading. Saturated sand shall not be used. The bedding sand shall be spread loose in a uniform layer as per drawing. The compacted uniform thickness shall be of 45 mm and within +/- 5 mm. Thickness variation shall not be used to correct irregularities in the base course surface.

The spread sand shall be carefully maintained in a loose dry condition and protected against pre-compaction both prior to and following screeding. Any precompacted sand or screeded sand left overnight shall be loosened before further laying of paving blocks take place.

Sand shall be slightly screeded in a loose condition to the predetermined depth only slightly ahead of the laying of paving unit.

Any depressions in the screeded sand exceeding 5 mm shall be loosened, raked and rescreeded before laying of paving blocks.

**7.4 LAYING OF INTERLOCKING PAVER BLOCKS :-**

Paver blocks shall be laid in herringbone laying pattern throughout the pavement. Once the laying pattern has been established, it shall continue without interruption over the entire pavement surface. Cutting of blocks, the use of infill concrete or discontinuities in laying pattern is not be permitted in other than approved locations.

Paver blocks shall be placed on the uncompacted screeded sand bed to the nominated laying pattern, care being taken to maintain the specified bond through out the job. The first row shall be located next to an edge restraint. Specially manufactured edge paving blocks are permitted or edge blocks may be cut using a power saw, a mechanical or hydraulic guillotine, bolster or other approved cutting machine.

Paver blocks shall be placed to achieve gaps nominally 2 to 3 mm wide between adjacent paving joints. No joint shall be less 1.5 mm not more than 4 mm. Frequent use of string lines shall be used to check alignment. In this regard the "laying face" shall be checked at least every two meters as the face proceeds. Should the face become out of alignment, it must be corrected prior to initial compaction and before further laying job is proceeded with.

In each row, all full blocked shall be laid first. Closure blocks shall be cut and fitted subsequently. Such closer blocks shall consist of not less than 25% of a full blocks.

To infill spaces between 25 mm and 50 mm wide concrete having screened sand, coarse aggregate mix shall be used. Within such mix the nominal aggregate size shall not exceed one third the smallest dimension of the infill space. For smaller spaces dry packed mortar shall be used.

Except where it is necessary to correct any minor variations occurring in the laying bond, the paver blocks shall not be hammered into position. Where adjustment of paver blocks necessary care shall be taken to avoid premature compaction of the sand bedding.

**7.4.1 INITIAL COMPACTION :-**

After laying the paver blocks, they shall be compacted to achieve consolidation of the sand bedding and brought to design levels and profiles by not less than Two (2) passes of a suitable plate compactor.

The compactor shall be a high-frequency, low amplitude mechanical flat plate vibrator having plate area sufficient to cover a minimum of twelve paving blocks. Prior to compaction all debris shall be removed from the surface.





Compaction shall proceed as closely as possible following laying and prior to any traffic. Compaction shall not, however, be attempted within one metre of the laying face. Compaction shall continue until lipping has been eliminated between adjoining blocks. Joints shall then be filled and recompact as described in Cl. 3.5.

All work further than one metre from the laying face shall be left fully compacted at the completion of each day's laying.

Any blocks that are structurally damaged prior to or during compaction shall be immediately removed and replaced.

Sufficient plate compactors shall be maintained at the paving site for both bedding compaction and joint filling.

#### 7.4.2 JOINT FILLING AND FINAL COMPACTION :-

As soon as possible after compaction and in any case prior to the termination of work on that day and prior to the acceptance of vehicular traffic, sand for joint filling shall be spread over the pavement.

Joint sand shall pass a 2.36 mm (No.8) sieve and shall be free of soluble salts or contaminants likely to cause efflorescence. The same shall comply with the following grading limits.

In Sieve Size	% Passed
9.52 mm	100
4.75 mm	95-100
2.36	80-100
1.18	60-100
600 Microns	25-60
300 Microns	10-30
150 Microns	5-15
75 Microns	0-10

The Contractor shall supply a sample of the jointing sand to be used in the contract prior to delivering any such materials to site for incorporation into the works. Certificates of test results issued by a recognized testing laboratory confirming that the samples conform to the requirements of this specifications shall accompany the sample.

The jointing sand shall be broomed to fill the joints. Excess sand shall then be removed from the pavement surface and the jointing sand shall be compacted with not less than one (1) Pass by the plate vibrator and joints refilled with sand to full depth.

This procedure shall be repeated until all joints are completed filled with sand. No traffic shall be permitted to use the pavement until all joints have been completely filled with sand and compacted.

Both the sand and paver block shall be dry when sand is spread and broomed into the joints to prevent premature setting of sand.

The difference in level (lipping) between adjacent blocks shall not exceed 3 mm with not more than 1% in any 3 m x 3 m area exceeding 2 mm. Pavement which is deformed beyond above limits after final compaction shall be taken out and reconstructed to the satisfaction of the Engineer.

#### 7.4.3 EDGE RESTRAINT :-

Edge restrains need to be sufficiently robust to withstand override by the anticipated traffic, to withstand thermal expansion and to prevent loss of the laying course material from beneath the surface course. The edge restraint should present a vertical face down to the level of the underside of the laying course.

The surface course should not be vibrated until the edge restraint, together with any bedding or concrete haunching, has gained sufficient strength. It is essential that edge restraints are adequately secured.

#### 7.5 SAMPLING AND TESTING PROCEDURES FOR PAVER BLOCKS :-

##### 7.5.1 SAMPLE SIZE:-

Internal - Average of minimum 3 samples per 5000 blocks - for paver block manufacturers.

External - Minimum 2 blocks per 10000 blocks. Average of minimum 8 blocks per site - for captioned contractors.

##### 7.5.2 SAMPLING FOR TESTING :-

Sampling for testing of paver blocks shall be done in accordance with Appendix-A.

##### 7.5.3 COMPRESSIVE STRENGTH :-

Testing for 28 days compressive strength shall be undertaken in accordance with Appendix-B. The average compressive strength of 60 mm thick paver blocks tested shall be 31.8 MPa.

Note:- 10% lower tolerance limit in compressive strength shall be allowed.

#### 6.5.4 WATER ABSORPTION :-

Testing for water absorption shall be in accordance with IS 2185:1979:Part I (Specifications for concrete masonry blocks) Appendix C



APPENDIX -A  
SAMPLING OF PAVER BLOCKS :-  
Method of Sampling:

The paver blocks required for carrying out the tests, a sample of 20 block shall be taken from every consignment of 4000 blocks or part thereof the same size, shape and thickness and the same batch of manufacture from these samples the blocks shall be taken at random for conducting the tests.

7.5.5 MARKING AND IDENTIFICATION :-

All samples shall be clearly marked at the time of sampling in such a way that the designated section of Part thereof and the consignment represented by the sample, are clearly defined.

The sample shall be dispatched to the approved test laboratory taking precaution to avoid damage to the paving in transit. Protect the paving from damage and contamination until they have been tested. The samples shall be stored in water at 20°C + 5°C for 24 hours prior to testing.

APPENDIX - B

PROCEDURE FOR TESTING OF COMPRESSIVE STRENGTH FOR PAVER BLOCK :

Reference: BS 6717 Part I (1993) Specification for Paver Blocks B-1 Testing Machine: The testing machines shall be of suitable capacity for the test and capable of applying the load at the rate specified. It shall comply, as regards repeatability and accuracy with the requirements of relevant IS specification.

B-2 Procedure - The sample specimens shall be tested in wet condition after being stored at least 24 hours, in water maintained at a temperature of 20°C + 5°C before the specimens are submerged in water, the necessary area shall be determined.

The plates of the testing machine shall be wiped clean and any loose grit or other material removed from the contact faces of the specimen. Plywood nominally 4 mm thick, shall be used as packing between the upper and lower faces of the specimen and the machine plates, and these boards shall be larger than the specimen by a margin of at least 5 mm at all points. Fresh packing shall be used for each specimen tested. The specimen shall be placed in the machine with the wearing surface in a horizontal plane and in such a way that the axes of the specimen are aligned with those of the machine plates. The load shall be applied without shock and increased continuously at the rate of approximately 15 N/sqmm per minute until no greater load can be sustained. The maximum load applied to the specimen shall be recorded.

B-3 CALCULATION OF CORRECTED STRENGTH:-

The compressive strength of each block specimen shall be calculated by dividing the maximum load by full cross section area and multiplying by an appropriate factors.

Thickness and Chamfer Correction Factors  
For Compressive Strength

Work Size thickness in mm	Correction Factors	
	Plain Block	Chamfered
60	1.00	1.06
80	1.12	1.18
100	1.18	1.24

B-4 COMPRESSIVE STRENGTH CALCULATION:-

The average corrected compressive strength for the designed block section shall be calculated.

APPENDIX -C

METHOD FOR THE DETERMINATION OF WATER ABSORPTION:-

The test specimens shall be completely immersed in water at room temperature for 24 hours. The specimens shall then be weighed, while suspended by a metal wire and completely submerged in water

They shall be removed from the water and allowed to drain for one minute Visible surface water being removed with a damp cloth and immediately weighed

Subsequent to saturation, all specimens shall be dried in a ventilated oven at 100 to 115°C for not less than 24 hours and until two successive weightings at intervals of 2 hours show an increment of loss not greater, than 0.2 percent of the last previously determined mass of the specimen.

Calculate the absorption as follows:

$$\text{Absorption, kg/m}^3 = \frac{A-B}{B-C} \times 10000$$



Absorption percent  $\frac{A-B}{B} \times 100$   
 Where

A = wet mass of unit in kg  
 B = dry mass of unit in kg. And  
 C = suspended immersed mass of unit in kg.

**ITEM NO.103:**

Providing 100mm th. Ready made c.c. kerb of strength M-20 (Size 300mm X 380mm) purchased from SMC's approved paverblock manufacturer & setting in line level and in truly vertical position, including filling joints in C.M. 1:1 (1 part of cement : 1 part of stone dust ) smooth pointing in C.M. 1:1 ( 1 part of cement : 1 part of coarse sand) including watering etc. complete and as directed by engineer in charge.

5(A) For regular edge of footpath

5(B) For rounding at the edge of footpath (for fanning portion) (No.x2 - R)

Item includes all materials, labour, equipment, tools, plants, watering, cleaning etc. complete.

**RAW MATERIAL:****CEMENT:-**

The cement used in the manufacture of high quality precast concrete paving block shall be conforming to IS 12269 (53 grade) ordinary Portland Cement or IS 8112 (43 grade ordinary Portland cement). The minimum cement content in concrete used for making paver blocks should be 310 kg/Cu.M. And the upper limit of cement shall not be more than 425kg/Cu.M.

**AGGREGATES :-**

The fine and coarse aggregates shall consist of naturally occurring crushed or uncrushed materials which, apart from the grading requirements comply with IS 383-1970. The fine aggregates used shall contain a minimum of 25% natural silicon sand. Lime stone aggregates shall not be used. Aggregates shall contain no more than 3% by weight of clay and shall be free from deleterious salts and contaminants.

**WATER :-**

The water shall be clean and free from any deleterious matter. It shall meet the requirements stipulated in IS:456-2000.

**OTHER MATERIALS :-**

Any other material/ingredients used in the concrete shall conform to latest IS specifications.

**C.C.BLOCK CHARACTERISTICS:**

The C.C. block should have perpendicularities after release from the mould and the same should be retained until the laying.

The concrete mix design should be followed for each batch of materials separately and automatic batching plant is to be used to achieve uniformity in strength and quality.

The C.C. block shall be manufactured in single layer only. Skilled labours should be employed for laying blocks to ensure line and level, for laying, desired shape of the surface and adequate compaction of the sand in joint.

The C.C. block must be of size 300 mm x 100 mm x 380 mm and casted in M-200 Grade with 4" (110 mm) radius rounding at the top and 2 (two) nos. 12 mm keys at the other vertical face as directed by Engineer-in-charge.

When foot path meets with a junction or approach road at the end of foot path, a turning radius equal to the width of foot path should be made as per below and as directed by Engineer-in-charge.

Sr No.	Turning Radius	No. of C.C. Block to be fix	Size of C.C. Block in rounding
1.	1.00 mt.	4 Nos.	Outer 370 mm x inner 340 mm x thickness 100 mm x Height 380 mm
2.	1.50 mt.	6 Nos.	
3.	2.00 mt.	8 Nos.	

Strength is measure of the ability of the concrete kerb unit to withstand load. It is determined under laboratory conditions using bending strength. A load is uniformly applied through a 401mm swivel parallel and rigid bearers rounded to a radius of 201mm until failure is reached. For each kerb the individual strength in MPa is determined using the second moment of area. For each of calculation, the second moment of area and distance from the centroid to the extreme tensile fibre are incorporated for the profiles specified within the standard. For other profiles please refer to individual manufacturers who will supply the relevant information. The bending strength in MPa is recovered to check compliance with BS EN, The number of the kerbs per sample will vary depending on previous production performance assessed statistically by attributes of variables.



The characteristic bending strength shall not be less than the value corresponding to the class in the table that follows. None of the individual results shall be less than the corresponding minimum bending strength in the table. Where kerbs, due to their geometry, cannot be tested according to this standard they shall be considered to be in the same class as tested kerbs provided they have at least the Bending strength classes.

Class Strength	Marking (MPa)	Characteristic Bending (MPa)	Minimum Bending Strength
1	S	3.5	2.8
2	T	5.0	4.0
3	U	6.0	4.8

#### WEATHERING RESISTANCE:

Is a measure of the ability of the concrete kerb to withstand weathering specific conditions exist such as frequent contact of the surface with de icing salt under frost conditions. It can be assessed under laboratory conditions by measuring the amount of spalled material from a surface under the cycle of freezing thawing action using a deicing salt solution, or, if de-icing salt is used, then the measurement of the porosity by measuring the water absorption of the kerb could be used.

#### ABRASION RESISTANCE:

Is a measure of the ability of the concrete kerb to withstand erosion caused by trafficking in service. It is assessed under laboratory conditions by abrading the surface of the kerb with a flow of a hard abrasive material while applying a known force. The resulting loss of material from the kerb surface is measured by determining the abraded width.

#### SLIP/SKID RESISTANCE:

Is a measure of the ability of the concrete kerb laid in service to withstand slipping for pedestrians and skidding for vehicles. The unpolished slip resistance value is determined using standard rubber material attached to a pendulum friction tester and tested under wet conditions. To determine the polished pvaer value (PPV) for all paving units BS 7932:1988 should be used. This test method measures the slip resistance of the kerb after it has been synthetically trafficked (or polished) under laboratory conditions to replicate the performance of kerb during their life under traffic conditions. For more details please contact interpave.

Kerb and edgings are mainly used as edge restraints to paved surfaces or where changes in surface materials or levels occur. They retain any unbound construction material, e.g. laying course material, within the paved area and help support the applied loads by preventing horizontal displacement of the pavement construction. Channels may be used in these applications as well but can also be used to intercept and transport surface water. In vehicular areas kerb, edging and channel units will inevitably be overrun or suffer side impact from vehicle tyres sometime in their service life. By selecting the appropriate units and ensuring correct installation they will give long and durable service.

#### TOLERANCES:

Performance deviations the value for possible deviation from manufacturer's declared values are as follows.

##### Length:

1% to the nearest mm, with a minimum of 4mm and not exceeding 10mm.

##### Other dimensions:

Other faces : 3% to the nearest mm, with a minimum 3 mm not exceeding 5 mm.

Other parts : 5% to nearest mm, with a minimum of 3 mm not exceeding 10 mm.

##### Flatness and straightness:

Length of gauge mm	Permissible deviation mm
300	1.5
400	2.0
500	2.5
800	4.0

The difference between any two measurements of single kerb shall be  $\leq -5$ mm.

Installation of concrete kerbs, edging and channel units has five main stages:

- Preparation of support layers.
- Construction of unit foundation.
- Laying to line and level.
- Bedding of units.
- Haunching of units.

The unit foundation itself must be supported, either on an extension to the underlying pavement sub layers or, for thin pavements (e.g. edgings on pedestrian footways), directly on an adequate subgrade. The depth of the unit and that of the pavement construction will determine on which pavement layer the kerb foundation will sit.



Products should be laid using one of the following alternative methods:

1. Units set on a race of freshly mixed concrete.
2. Units bedded on a mortar bed on top of a hardened concrete race or onto a mortar bedding on a carriageway.
3. Units bonded to the pavement surface.

#### LAYING OF C.C. BLOCK AS KERB :

C.C. block shall be placed in line, level and in true vertical position with 12 mm gap including filling joints in C.M. 1:1 (1 Part of cement : 1 part of stone dust) and smooth pointing in C.M. 1:1 (1 cement of cement : 1 part of stone dust) including watering.

At the Residential units, it shall be kept 8" (200 mm) open above water table and at the commercial complex, it shall be kept 3" (75 mm) open above water table and as directed by Engineer-in-charge.

#### SAMPLING AND TESTING PROCEDURE FOR C.C. BLOCK:

Sample size:

- Internal : Average of minimum 3 samples per 3000 blocks - for paver block manufacturers.
- External : Minimum 3 blocks per 3000 blocks.

Sampling for testing :

Sampling for testing of C.C. kerb shall be done in accordance with Appendix-A in item no.6.

Compressive strength : testing for 28 days compressive strength shall be undertaken.

Abrasion Resistant: It is assessed under laboratory conditions by abrading the surface of the kerb with a flow of a hard abrasive material applying a known force. The resulting loss of material from the kerb surface is measured by determining the abraded width.

Bending strength : The characteristic bending strength shall be less than the value corresponding to the class. None of the individual results shall be less than the corresponding minimum bending strength.

The rate shall be for a unit of one R.M.

For ensuring quality control and workmanship, above test shall be taken at 01 (One) test per each 1000 (One thousand) Nos. of C.C. block.

The C.C. block shall be got tested at (R&B) field laboratory of GERI (R&B) or S.V.N.I.T., or Govt. approved laboratory.

Laying on pavement surface:

The units may be laid directly onto a suitable pavement surface which should extend to a width to fully support the units and any required haunching. The units are bonded to the surface using a suitable synthetic resin compound or with a modified strengthened mortar.

Jointing:

Concrete kerbs are generally laid with unfilled, close joints with a minimum joint width of 12 mm they must not be butt-jointed. Mortar joints should be filled by 1:1 (1 Cement : 1 stone dust) and finished with the mortar which should be freshly mixed, consisting of 1:1 (1 Cement : stone dust) where mortar joints are used, they should be completely filled and fully compacted. Joints width should be 12 mm.

Where units are laid over or adjacent to a jointed concrete pavement, suitable joints should extend through the line of the units at the joints and continue through the kerb race. When mortar joints are used, movement joints should be provided. These movement joints should be formed of 12 mm thick easily compressible material, extend through the kerb race. Mortar should be used as soon as possible and any material that has begun to set or has been mixed for more than two hours discarded.

Contractors need to plan the work to ensure risk is kept to an acceptable level. This may involve the following actions.

- Rethink the phasing of the kerb installation to maximise the number of kerbs being laid at one time.
- Lay direct from the pack rather than double handling by stringing out ahead of final laying.
- Use machinery capable of handling both packs and individual kerbs.
- Use machinery solutions for the handling of non standard kerb details such as feature kerbs, transition kerbs, drop kerbs, quadrants (cheeses) and radius kerbs.
- Ensure that workers are trained in the safe use of mechanical lifting equipment.
- Provide training in safe lifting techniques for works involved with kerb laying.
- Consider use of alternative lightweight kerb components for certain circumstances.

Kerb laying by hand involves a serious risk of injury to those who are doing the work and therefore employers need to take action to control this risk. When taking the risk, the best solutions will be those which address all three main hazards, the weight of the kerb, the repetitive nature of the operation and poor posture during work. The help find the best solution, the manual handling hierarchy of control measures is suggested. You should try to adopt the solution nearest the top of hierarchy first, as these will give the best level of risk control. In rare cases, where it is not possible to use any mechanical solutions, short stretches of kerb may be laid manually. Where this is necessary workers should be trained in good handling techniques. The use of lighter weight kerbs or devices that allow two people to share the lift will reduce the risk of injury.



**GENERAL GUIDANCE:**

It is important that work procedures are drawn up before commencement to identify any hazards. Failure to do this can result in lack of co-ordination of materials and multiple handling of product. Correct personal protective clothing should be provided.

**Planning the work:**

Work should be planned and coordinated to void unnecessary handling.

For operations where fork lift vehicals are used, kerbs should be stacked onto timber plaes. Ensure that pallets are robust as the failure of a pallet could allow kerbs to all.

Stripping and wrapping of packs should only be removing just prior to use of the kerbs.

Care should be taken when cutting bands and/or remvoing wrapping to avoidkerbs falling.

Accurate placement of the concrete bed will minimise shovelling operations.

Accurate preparation of the concrete bed and any excavated trench will reduce the amount of adjustment to kerbs once laid.

Where power tools are used for cutting these should be concrete cutters with diamond blades and water flow lubrication for cooling and dust suppression.

The rate should be for a unit of One R.M.

**ITEM NO. 104:**

Providing & construction INLET CHAMBER OF 750\*600\*1500 mm internal dimension with necessary excavation refilling 350 mm th. Brick masonry in1:4,150 mm th. P.C.C. & benching in c.c. 1:2:4, 12mm th. plaster in C.M. 1:3 for inside & cement

**104.1.0 MATERIALS :**

104.1.1 WATER : Water shall conform to M-1of detailed specification of materials.

104.1.2 SAND : Fine aggregate 0.15 mm to 5.00 (about 0.00597 to 3/16") I.S. sieve No.15 to 480 shall confirm to M-4 of detailed specifications of material.

**104.1.4 COARSE AGGREGATE :**

104.1.4.1 Coarse aggregate 5 mm to 40 mm shall conform to the latest version of relevant I.S. Specification and M-8A of detailed specification of material.

104.1.4.2 SIZE : The maximum size of coarse aggregate shall be as large as possible normally not greater than 1/4 of the minimum thickness of concrete member. In case of R.C.C., this size present no difficulty to surround the reinforcement thoroughly and fill up the form work fully and is less than the minimum cover by 6 mm for plain concrete. Maximum size of the coarse aggregate shall be up to 40 mm subject to the above limitation and provided no limiting size is specified in the special provisions.

104.1.4.3 Generally a maximum size of 20 mm shall be found satisfactory for reinforced concrete work.

104.1.4.4 The grading between the maximum size and minimum size of 5 mm shall be such as to produce a dense concrete of specified proportion and consistency that will work readily in to position without any aggregate and without the use of excessive water content.

104.1.5 CEMENT MORTAR : Sand or fine aggregate size 0.15 to 5 mm I.S. Sieve No.15 to 480 confirming to relevant specification shall be supplied by the contractor and it shall be mixed with portland cement in require proportion by volume. It shall be mixed dry and then requirement quantity of water shall be added before final mixing to have thoroughly mix mortar paste. Mortar shall preferably mixed in mixer.

**104.1.6 FLY ASH LIME BRICK :**

104.1.6.1 Fly ash lime brick shall be used for this item and shall comply with specification or relevant I.S. (latest version). Sample of Fly ash lime bricks shall be got approved by the Engineer, who will keep it in his office for reference.

**104.2.0 WORKMANSHIP :**

104.2.1 The chamber of different types and sizes as specified shall constructed in storm line at such places and such levels and dimensions as shown in drawing or as directed. PCC shall be in 1:4:8 cement concrete.



104.2.2 Bed Concrete : The inlet chamber shall be built in bed of cement concrete 1:2:4 as shown in drawing or as directed. The relevant specification if Item No. 4 shall be followed for 1:2:4 concrete proportion by volume.

104.2.3 WALLS : The walls of chamber shall be constructed using Fly ash lime bricks, having crushing strength not less than 75 Kg/Sq.cm. in C.M. 1:4 (1 Cement : 4 fine sand). The Fly ash lime brick masonry shall conform to relevant specification of M-6A of detailed specification of material. The jointing face of such Fly ash lime brick shall be well buttered with cement mortar before laying so as to ensure that full joints are filled up with mortar.

104.2.4 PLASTER : The inside of wall shall be plastered with 12 mm thick C.M. 1:3 (1 Cement : 3 fine sand) and finished with floating coat of neat cement. All angles shall be rounded to 7.50 cms. radius and all rendered internal surfaces shall have impervious finish obtained by a steel trowel. The external joints of masonry shall be finished smooth as directed.

#### 104.2.5 CHANNELS AND BENCHING :

104.2.5.1 Channels shall be semicircular in the bottom half and of diameter equal to the pipe of drain. Above the horizontal of diameter the sides shall be extended vertically to the level as the crown of the outgoing pipe and the top edge shall be suitably rounded off. The branch channels shall also be similarly constructed with respect to the benching but at their junction with the main channel with appropriate fall, suitably rounded off in the direction of flow in the main channel, shall be given.

104.2.5.2 The channel and benching shall be done in 1:2:4 grade rising at a slope in line from edges of channel. The channels of the bottom of the chamber shall be plastered with C.M. 1:2 (1 Cement; 2 coarse sand) and trowelled smooth.

104.2.6 FRAME FITTING : Perforated Precast R.C.C. Jali in CC M-30 as per drawing shall be fitted firmly in the precast frame which shall be laid over plaster on top of masonry. Cement mortar shall be 1 part cement and 2 parts of sand and layer shall be 25 mm thick.

#### 104.2.7 TESTING :

104.2.7.1 Chamber shall be tested by filling with water upto top as directed.

104.2.7.2 After completion of work, chamber covers shall be sealed by means of thick grease.

#### 104.3.0 MODE OF MEASUREMENTS AND PAYMENTS :

104.3.1 The rate includes all labours, materials, curing for 14 days, tools and plant, etc. required for satisfactory completion of this item as per drawing and as directed by the Engineer-in-charge.

104.3.2 The rate shall be for a unit of one chamber including RCC cover with frame.

#### ITEM NO.105 :

Demolition including stacking of serviceable materials and disposal of unserviceable materials with all lead and lift  
RCC WORK

#### 105.1.0 WORKMANSHIP :-

105.1.1 The term Demolition shall consist of one or more parts of the building as specified or shown in the drawing. Demolition implies taking up or down or breaking up. This shall consist of demolishing whole or part of work including all relevant items as specified or shown in the drawings. The demolition shall always be planned before hand and shall be done in reverse order of the one in which the structure was constructed. This scheme shall be got approved from the Engineer-in-charge before starting the work. This however will not absolve the contractor from the responsibility of proper and safe demolition. Necessary propping, the shoring and or under pinning shall be provided for the safety of the adjoining work or property, which is to be left intact, before dismantling and demolishing is taken up and the work shall be carried out such that no damage is caused to the adjoining property.

Wherever required, temporary enclosures or partitions shall also be provided. Necessary precautions shall be taken to keep dust nuisance down as and where necessary.

Dismantling shall be done in a systematic manner. All materials which are likely to be damaged by dropping from a height. The or demolishing roofs, masonry etc. shall be carefully removed first. The dismantled



articles shall be passed by hand where necessary, lowered the ground (as not thrown) and then properly stacked as directed.

All materials obtained from demolition shall the property of Corporation unless otherwise specified and shall be kept in safe custody until handed over to any store to Surat Municipal Corporation as specified the Engineer-in-charge.

Any serviceable materials, obtained during dismantling demolition, shall be separated out and stacked properly on site or any store of S.M.C. as directed, with all lead and lift. All unserviceable materials, rubbish etc. shall be stacked as directed by Engineer-in-charge. On completion of work the site shall be cleared of all debris rubbish and cleaned as directed.

105.3.0 Rates :

Measurements of all work except hidden work shall be taken before demolition or dismantling and no allowance for increase in bulk shall be allowed. The demolition of lime concrete shall be measured under this item. Specification for deduction for voids, openings etc. shall be on same basis as the employed for construction of work.

All work shall be measured in deciman system as fixed in its place subject to the following limit, unless otherwise stated hereinafter : (a) Dimensions shall be measured to the nearest 0.01 mt. (b) Areas shall be worked out to the nearest 0.01 cum.

The rate shall include cost of all labour involved and tools used in demolishing and dismantling including scaffolding. The rate shall also include the charges for separating out and stacking the serviceable materials properly and disposing the unserviceable materials with all lead and lift. The rate also includes for temporary shoring for the safety of the portion not required to be pulled down or of adjoining property and providing temporary enclosures or partitions where considered necessary.

The rate shall be for a unit of one cubic metre.

ITEM NO.106 :

Demolition of brick work and stone masonry including stacking of serviceable materials and disposal of unserviceable materials with all lead and lift

WORKMANSHIP :

The relevant specifications of Item No.105 shall be followed but read brick and stone masonry instead of R.C.C. work. The unserviceable materials shall be disposed of at all leads and lifts. The rate excludes scraping straightening of reinforcement but includes cutting of reinforcement.

The rate shall be for a unit of one cubic metre.

**ITEM NO.107:**

Dismantling tiled or stone floors laid in mortar including stacking of serviceable material and disposal of unserviceable material with all lead and lift

WORKMANSHIP :

The relevant specifications of Item No.105 shall be followed but read tiled or stone floor instead of R.C.C. work. The unserviceable materials shall be disposed of at all leads and lifts. The rate excludes scraping straightening of reinforcement but includes cutting of reinforcement.

The rate shall be for a unit of one Sq.metre.

**ITEM NO.108 :**

Dismantling chaping of plaster work from old masonry wall including disposal of unserviceable materials with all lead and lift.

WORKMANSHIP :

The relevant specifications of Item No.105 shall be followed but read chaping of plaster work from old masonry wall instead of R.C.C. work. The unserviceable materials shall be disposed of at all leads and lifts. The rate excludes scraping straightening of reinforcement but includes cutting of reinforcement.

The rate shall be for a unit of one Sq.metre.

**ITEM NO.109:**

Providing & laying cement concrete Pavement using 1:1.5:3 (1 cement:1.5 sand:3 graded stone agg. 20 mm nominal size) & Vacuum Dewatering technique including floating surface with a skim powder floater, curing etc. complete

The whole work to be carried out by a specialized agency approved by Consultant/Engineer In Charge and shall be guaranteed fully effective. Not withstanding, the responsibility of the effectiveness of the work should be fully, entirely be that of the main contractor for the contract.

Concrete Materials:

(A) 12mm and downgraded crushed metal of black trap stone as coarse aggregate.



(B) Fine sand as fine aggregates.

(C) Cement

Concrete Mix:

(A) 1:1.5:3 (Cement: Sand: Coarse aggregates) in volumetric proportions.

(B) The concrete shall have the plastic consistency of K2/K3, slump between 8 to 12 cms.

Subbase: -

The subbase shall be sufficiently strong, well compacted.

Process of Work:

1) Before placing concrete on the sub base, waterproof paper shall be laid on the sub base act as a separation layer for protection against humidity and water.

2) Concrete of mix and consistency as mentioned above shall then be laid on the paper in base of not more than 20 mts x 20 mts by providing ISMC 150 channels well secured to withstand the vibrations of a vibrator. The thickness of the concrete so laid shall be 10cms.

**PLANNING OF PLACING**

The Contractors shall submit for review shop drawings for floor slabs detailing the location of all construction joints and the sequence of the slab placement, and manufacturer's literature describing the equipment to be used. In addition to the shop drawings, the Contractor shall indicate the quantity of each piece of dewatering equipment that will be located at the construction site and shall include the dimensions of all suction mats.

Before concreting is started the work should be planned with a view to determine areas to be placed daily, the required amount of equipment, size of vacuum mats, length of vacuum hoses, arrangement of rails, if any, or screeds etc. Crew required for the vacuum process is two men to handle the mats and the pump. Note that placing, vibration, vacuum treatment and floating follow immediately behind each other.

**GENERAL :-** The work shall be planned and executed so that there is no delay between the placement, screeding, dewatering and floating of the concrete. Concrete to be vacuum dewatered shall be handed and placed so as to prevent segregation. The concrete shall be internally vibrated prior to screeding.

**LEVELLING:-** Immediately following placement, the concrete shall be leveled with a vibrating screed running on a true surface, set at the proper elevation required to provide the specified finished elevation. The concrete surface shall be screeded high by 2% of the slab's thickness to compensate for the compaction caused by the vacuum dewatering process. (Slabs to have an aggregate hardener shall have compensation made to maintain elevation). The vibrating screed shall be moved forward as rapidly as proper consolidation allows. The proper surcharge of concrete must be maintained in front of the leading edge of the screed.

**Vacuum :-** Immediately after leveling, the concrete shall be covered with filter pads and suction mats in strict accordance with the recommendation of the manufacturer to have the slab fully dewatered. The suction mat shall extend 100mm beyond the edge of the filter pad on all sides. The pads shall extend to within 100mm of the edge of concrete slab, and the mats shall cover entire slab. Before connecting the hose on the suction mat to the vacuum pump, the edges of the mat shall be smoothed to enable an airtight seal to be created. A vacuum pump, the edges of the mat shall be smoothed to enable an airtight seal to be created. A vacuum shall then be applied to the mat. After a minute the gauge on the vacuum pump should indicate a minimum vacuum of 0.700 atmospheres (500mm/Hg) and if not, the mat must be checked for leakage. For concrete that dewaterers readily the vacuum should then be maintained at 0.70-0.80 atmospheres (500/600mm/Hg) for concrete which dewaterers less efficiently the vacuum shall then be reduced to 0.50-0.60 atmospheres (300-400mm/Hg). After approximately 10 minutes the vacuum can then be increased to 0.80 atmospheres.

The vacuum shall be maintained for at least 1 minute per cm fied, sufficient moisture shall be maintained to meet manufacturer's requirements). The suction mats and filter pads shall then be removed and moved to the next section in a leapfrog manner.

Stop the vacuum dewatering when light footprints only are left in the concrete when stepped upon.

**FLOATING**

Upon removal of the suction mats and filter pad the concrete surface shall be power-floated without delay until all imprints from the vacuum process are removed. If crusting occurs, the floating operation must be delayed till the concrete carries the machine.

The higher speed is recommended for the floating operation. Two passes with the floating disc should be made in the junction of two mats in order to avoid risk for cracking.

**FINISHING**

The waiting time after the floating operation depends on concrete temperature and humidity and varies from 10 minutes to 2 hours.

The trowelling operation cannot take place before the concrete has hardened enough to carry the machine; i.e. the trowelling blades will not leave any marks on the concrete. Repeated trowelling, with intervals between the passes which are adapted to the setting of the concrete, greatly improves the surface characteristics. The surface will be more wear-resistant and less dusty.

At least two passes are recommended for floors which are not to be covered.

**CURING**

Vacuum dewatered concrete should be cured like any other quality concrete in order to achieve a good final result. Use ponding or wet burlap.

**Equipment specifications**

- a. Poker/Needle Vibrators: Vibrators with more than 12500 vibrations/minute with drive length exceeding Bay width by atleast 1 mtr. Shall be used.
  - b. Surface Vibrators: Double beam Surface Vibrator with beam spacing of 300 mm., Beam Height of 100 mm. with Weight not exceeding 15 kg. / Running Meter, Profile: Hollow to avoid loss of vibrations with vibrator unit of 2360 vibrations/min. having adjustable fly weight torque from 1.5 to 5.0 kg. /cm. and adjustable centrifugal force from 1350 to 4600 N. The Surface Vibrator will be equipped with suitable arrangement to remove sagging due to self weight and usage related stress fatigue. The surface vibrator will have a travel speed of about 1 Rmt/min.
  - 3 Vacuum Pump: The Vacuum Pump shall have a Priming tank with Separate suction and discharge compartment, having special filter arrangements to avoid entry of dirt in the pump body, The pump should run at > 280 RPM and produce vacuum upto 600 mm/Hg (-0.70 Atmospheres) An appropriate gauge should be provided to indicate the level of vacuum achieved. A valve to adjust the vacuum will be provided on the vacuum pump to control the vacuum created. The suction and discharge hoses should be provided with leak proof couplings and should be capable to withstand the pressure. The suction hose should also be provided with a valve to prevent backflow of water. The pump shall be capable to dewater concrete surface area of 24 m2 with single connection and 48-m2 max. with double connection without any extra modification. The pump unit shall be mounted on a trolley for ease in shifting during the course of work and should be less than 150 kg. in weight (DRY) for easy handling and operation.
  - 4 The suction Mat-Top Cover should be made of calendared PVC/PE Sheet Reinforced with Nylon/PP/LDPE fibers for withstanding the Pressures and provide flexibility for effective sealing to allow for proper vacuum creation. For a mat size of 24 m2 the centrally Provided Suction net area shall be minimum 0.5m2 to evenly distribute the vacuum. This suction net area shall have suitable openings for effective vacuum and will have a set of Nylon wire mesh to create sufficient cross sectional area for water to flow through. The suction pipe fitted on top cover should be fixed with appropriate gaskets to avoid any leakage.
  - 5 The filter pads should be made from Calendared Plastic Sheets with non-collapsible distance cushions to allow sufficient cross sectional area for effective flow of water. The filter pads shall have markings to indicate overlap distances for ease in usage by labour/operators handling the same.
  - 6 The finishing Equipment - Skim floaters should not exceed 100 kg/m2 weight, so as to avoid disturbing the freshly laid - dewatered concrete. The machines shall have 2 speeds to regulate the level and quality of finish. The machine should be capable of doing both functions floating and trowelling for faster output and ease of operation. The floating disc will have a gentle curvature and oscillating motion to achieve better level control and effectively seal the capillary pores of dewatered concrete. The machine should be capable of after grinding hydrated cement to result in improved wear resistance. The trowelling blades should be adjustable in tilt to increase or decrease the contact area of the trailing edge to achieve the desired finish and better abrasion resistance. The machine handles shall be at least 2 mtrs. in length with arrangements to increase or decrease the height for ease in operation and to allow to reach the concrete surfaces with minimum stepping upon concrete surface.
- Quality Control & Testing:**
- 1 Side Form: Side form shall be rigid enough to ensure that it does not Bulge/Collapse during the concreting. The top edge - level guide shall be straight to achieve final floors in the level tolerance of + 6mm per 4 meters on Transverse or linear directions.
  - 2 Equipment: The equipment shall be as per equipment manufacturers specifications of Aquarius "Tremix" make or equivalent and shall be in proper working condition. The Authority will have a right to get the same inspected and certified through the manufacturer at any time during the course of work for its performance and genuinity, any cost towards such inspection/certification will be borne by the contractor
  - 3 The concrete after vacuum dewatering and finishing shall give a minimum increase of 25% in compressive strength - vis a vis to reference concrete and a minimum 50% increase in abrasion resistance vis-a-vis to reference concrete. This may be either checked by cast in situ cubes or by cores taken after 7-14 & 28 days. Depending upon the total volume of work suitable quantities of samples shall be taken and checked. The testing should be a mandatory requirement as the cost paid towards equipment application is solely for the purpose of improved quality. Contractors at their expenses will do the entire arrangements for such sampling & testing.
- Special Terms & Conditions;**
- 1 The equipment will be Aquarius "Tremix" make or equivalent as per equipment specifications and performance. The Authorities will have the right to get the same inspected and certified through approved certification Agency and the costs of such inspections Certifications will be borne by the Contractor. Any defects found by the Certification Agency will be rectified immediately without which any further work execution will not be allowed. The costs of such rectifications will be borne by the contractor.
  - 2 Test panel before start of work shall be executed by the Contractor at his own costs and only after satisfactory 7 day results the actual work will be started in case of test panel results not being satisfactory one more chance will be provided before rejection of work / agency.
  - 3 All test samples for the test panel and actual work - either by way cast in situ cubes or cores will be tested by approved testing authorities only and the costs for such tests will be borne by the contractor.
  - 4 The necessary arrangements for test samples such as sufficient quantities of cube moulds / core drills etc. etc. will be arranged for by the contractor at his own costs.





- 5 The Engineer-in-Charge of site will have the right to demand samples from any working day's concrete at any time and the same will be provided by the Contractor immediately at his own cost.

**MODE OF MEASURE AND PAYMENT:**

The Rate shall be for a unit of one cubic meter.

**ITEM N0.110:**

Providing, supplying and placing RCC precast Wooden garden benches as per following specifications within city limit of Surat Municipal Corporation .All components are manufactured by using M-30 grade of concrete using Vibration Compression Process.Benches consist of 2 Nos. L-shaped base support in wooden texture and 1 Nos. flat Brick and 1Nos. bottom plank,leg thickness 90mm, Leg height 330mm. Leg width 600mm ,backside Plank width 350mm ,backside plank length 1300mm, backside plank thickness 60mm. Seating plank dimensions seating Length of the Bench 1300mm seating width of the bench 450mm seating height of the bench 450mm .Seating plank thickness 60mm ,Total height of the bench 900mm. All components are reinforced suitably for long use and to prevent during handling transportation and fitting..All parts are joined together with galvanised belt of suitable size and bolts are sealed with cover. Bench top and back planks are treated with special anticorrosive ,water proof coating, prevent sun, rain, light and anti-fungal attack as to make surface glossy and water proof ,reinforcement should be as per given drawing .the back rest should show SMC for benches use for gardens and corporators name and grant year (use for coporator grant), as detail given by SMC in embossed at casting time OR as per directed by engineer-in-charge .Note Rate should be as per inclusive of all taxes.

Detail technical specification as per item description and as directed by engineer-in-charge

**ITEM N0.111:**

**Informatory sings:-** Providing and fixing sing boards made out of 2 mm aluminium sheet; size 80 x 60 cms. Rectangle as per design of IRC 67-1977.pre treated with phosphating process & acid etching; coated with one coat of epoxy primer and two coats of best quality epoxy paint; reflectorised with retro reflective sheeting as per latest M.O.S.T. Specification; 3.1 m long stand post and frame fabricated from suitable size iron angle of 35 x 35 x 3 mm,75 x 75 x 6 mm as required;painted with best quality epoxy coating in black and white bends.The details of symbol for each board shall be as per the instruction of engineer in charge. The fixing at site shall be in 1:2:4 CC block of size 45 x 45 x 60 Cms.for each leg.including excavation,curing etc.complete under the supervision of engineer in charge.(B)High intensity Grade.

Detail technical specification as per item description and as directed by engineer-in-charge

**ITEM N0.112:**

**Cautionary Warning Sign:-** Providing and fixing sing boards made out of 2 mm aluminium sheet; size 90 x 90 x 90 cms. Equilateral triangle as per design of IRC 67-2012. pre treated with phosphating process & acid etching coated with one coat of epoxy primer and two coats of best quality epoxy paint;reflectorised with retro reflectivesheeting as per latest M.O.S.T. Specification;3.1 m long stand post and frame fabricated from suitable size iron angle of 35 x 35 x 3 mm,75 x 75 x 6 mm as required; painted with best quality epoxy coatings in black and white bends.The details of symbol for each board shall be as per the instruction of engineer in charge.The fixing at site shall be in 1:2:4 CC block of size 45 x 45 x 60 Cms.for each leg.including excavation,curing etc.complete under the supervision of engineer in charge.(B)High intensity Grade.

Detail technical specification as per item description and as directed by engineer-in-charge

**ITEM N0.113:**

**Regulatory/Mandatory sing:-** Providing and fixing sing boards made out of 2 mm aluminium sheet; size 60 cms. Diametercircle as per design of IRC67-2012. pre treated with phosphating process & acid etching with one coat of epoxy primer and two coats of best quality epoxy point; reflectorised with retro reflective sheeting as per latest M.O.S.T. Specification;3.1 m long stand post and frame fabricated from suitable size iron angle of 35 x 35 x 3 mm,75 x 75 x 6 mm as required;painted with best quality epoxy coating in black and white bends.The details of symbol for each board shall be as per 1:2:4 CC block of size 45 x 45 x 60 Cms.for each leg.including excavation,curing etc.complete under the supervision of engineer in charge.(B)High intensity Grade.

Detail technical specification as per item description and as directed by engineer-in-charge

**ITEM N0.114:**

**Direction sing(junction board):-** Providing and fixing sing boards made out of 2 mm aluminium sheet; size 244 x 122 cms. Rectangle as per design of IRC 67-2012. pre treated with phosphating process & acid etching; coated with one coat of epoxy primer and two coats of best quality epoxy paint; reflectorised with retro reflectivesheeting as per latest M.O.S.T. Specification; letters and numerals should be as per IRC-30-1968,3.1m long (2 nos) stand post and frame fabricated from suitable size iron angle of 50 x 50 x 5 mm,75 x 75 x 6 mm as required;painted with best quality epoxy coatings in black and white bends. The details of symbol or inscription/numerals for each board shall be as per the instruction of engineer in charge.The fixing at site shall be in 1:2:4 CC block of size 45 x 45 x 60 Cms.for each leg.including excavation,curing etc.complete under the supervision of engineer in charge.(B)High intensity Grade.

Detail technical specification as per item description and as directed by engineer-in-charge

**ITEM N0.115:**

The glazing has to be done using semi-unitized system. The main frames both verticals and horizontals have to be pipes of 64mm x 38 mm of 2.9 mm thick and sub frame of size 25mm x 50mm 1.6mm thick all colour anodized of 15 microns. The glass shall be glaverbel 5mm to 6mm toughened super silver grey or. equivalent The glass shall be stucked to the sub-frame with.Norton or equivalent tape as spacer and Dow Corning 995 as silicon. The silicon manufacture has approve



the same. Later the grooves shall be filled with Dow Corning 789. The hardware used shall be aluminum or hot - dip galvanized. Water penetration testing has to be done on site. including opening (Hardware) of Window  
Detail technical specification as per item description and as directed by engineer-in-charge

**ITEMS NO. 116:-**

Providing and fixing the S.S. Tubular/Angles/Flats as per the given Arch's design and engineer-in-charge. Rate to include welding, lifting, placing, electric rods etc. complete welding rods to be used as per the Indian Standards. (as per approval of architect's specification ,selection & detail.)

**Detailed specifications as per Item Description.****ITEMS NO. 117:-**

Providing and fixing of PVC carpet on Floor stick With fixing on existing flooring by adhesive material including finished with flush pointing & cleaning the surface etc. Comp  
Thickness 2 to 4 mm , Surface pattern is Lichee, Sand Grain , Wooden or plain Roll Size = 15 x 1.5 /1.8/ 1.42 m  
. (as per approval of architect's specification ,selection & detail.)

**Detailed specifications as per Item Description.****ITEMS NO. 118:-**

Providing & Fixing Polycarbonate sheet roofing with surface of the sheet is coated with an anti-UV Co-extrusion layer having good weather resistance, it can maintain its optical properties and mechanical performance for a long time. Fastening is usually done by screws. , The fastening screws should be inserted about 500 mm apart and 300mm apart Along the supporting internal purlin and edge purlin. All fixing holes with diameter at least 2 mm larger than screw must be predrilled into each screw location. The screws should be 6mm diameter with length according to sheet thickness and corrosion resistant, with at least heavy duty hot dipped galvanized or stainless steel. Excluding the cost of purlins rafter and trusses. (as per approval of architect's specification ,selection & detail.)

**Detailed specifications as per Item Description.****ITEMS NO. 119:-**

Supply and fixing of KALZIP 65/400 - Self  
SUPPORTED" SECRET FIX STANDING ROOFING  
SYSTEM IN 0.9mm THICK AA 3004 ALUMINIUM

ALLOY, comprising of the following layers: i. Exterior Layer –

Top layer –Kalzip 65/400 Straight profiled sheeting manufactured from Aluminum Alloy AlMnMg1- as specified in BS EN 1396 (comparable AA 3004), minimum material thickness of 0.9 mm and PVDF finish. The material properties are as follows:- Ultimate tensile strength: minimum 200 N/mm<sup>2</sup> 0.2% Proof Stress: minimum 185 N/mm<sup>2</sup> Modulus of

elasticity:70,000 N/mm<sup>2</sup>

The fluorocarbon coating (2-coat system) shall consist of:-

First coat -Inhibitive primer, with a dry film thickness averaging 5-7µm

Second coat -Fluorocarbon colour coat, with a minimum dry film thickness of 20 microns.

The inner side of the panels shall be finished with primer coating of 5-7 microns

Detailed structural calculations shall be provided by the manufacturer for the Clip Pull out force. Each aluminum clip shall come with a 5mm height black polyamide thermal barrier pad. Other relevant accessories like, Ridge closures, gable end channels, tolerance clips, gable end clips, foam fillers etc to be included as appropriate and wherever necessary. Corrugation cavities shall be closed off from the outside and inside of the building to ensure a tight fit leaving no gaps

Supply and fixing of KALZIP 65/400 - Self  
SUPPORTED" SECRET FIX STANDING ROOFING  
SYSTEM IN 0.9mm THICK AA 3004 ALUMINIUM

ALLOY, comprising of the following layers: i. Exterior Layer –

Top layer –Kalzip 65/400 Straight profiled sheeting manufactured from Aluminum Alloy AlMnMg1- as specified in BS EN 1396 (comparable AA 3004), minimum material thickness of 0.9 mm and PVDF finish. The material properties are as follows:- Ultimate tensile strength: minimum 200 N/mm<sup>2</sup> 0.2% Proof Stress: minimum 185 N/mm<sup>2</sup> Modulus of

elasticity:70,000 N/mm<sup>2</sup>

The fluorocarbon coating (2-coat system) shall consist of:-

First coat -Inhibitive primer, with a dry film thickness averaging 5-7µm

Second coat -Fluorocarbon colour coat, with a minimum dry film thickness of 20 microns.

The inner side of the panels shall be finished with primer coating of 5-7 microns

Accessories,

Aluminum ST clips – in grade 6061- T6 , of suitable height, with spacing as required for the wind loads. Detailed structural calculations shall be provided by the manufacturer for the Clip Pull out force. Each aluminum clip shall come with a 5mm height black polyamide thermal barrier pad. Other relevant accessories like, Ridge



closures, gable end channels, tolerance clips, gable end clips, foam fillers etc to be included as appropriate and wherever necessary. Corrugation cavities shall be closed off from the outside and inside of the building to ensure a tight fit leaving no gaps

- ii. Insulation layer – Rockwool Insulation of overall thickness 100 mm and density 64 kg/m<sup>3</sup>. K-value 0.038 W/mK as per standard ASTM C-518. Fire classification as per BS 476: Part 6&7 / EN-1350-1 / UL-273.
- iii Vapour Barrier : 1 layer of vapor control barrier- up to 150 microns thickness double sided aluminium foil
- iv. Galvalume Liner: 0.5 mm thick precoated Galvalume Liner in 35/200 Trapezoidal profile. The liner shall be with galvalume 550MPA colour coated.

All fasteners connecting Clips to purlins, shall be of austenitic stainless steel 304 series or higher in order to prevent corrosion / galvanic action with the components fastened.

Item includes Designing, Supplying, installation and fixing of profiled aluminium sheeting including Clips, stainless steel fasteners, thermal barrier pads, inner closure at ridge and eaves with rivets and also providing all machineries (Straight profile machine) required for the project.

Note:

- Purlin spacing should be 1200-1400mm.

**Detailed specifications as per Item Description.**

**ITEMS NO. 120:-**

Providing and laying kitchen platform of width 75cm with top 16mm Thick 100% Vitrified platform 800 x 2400 mm flooring, treads of steps & landing laid on a bed of 12 mm thick C.M. 1:6 (1 Cement : 6 Coarse sand ) Finished with flush pointing in white or colour cement. with bottom of polish kotastone including front side 100mm fascia patti (horizontal) of polish granite including req. partition support of double side polished Kota

Materials :-

Water shall conform to M-1. Lime mortar shall conform to M-10 cement mortar shall conform to M-11 polished kota stone shall conform to M-49.

44.2.0 Workmanship :-

44.2.1 Each slab shall be cut to the required size and shape and fine chisel dressed at all the edges. The sides thus dressed shall have a full contact if a straight edge is laid along. The sides shall be table rubbed with on coarse sand before paving. All angles and edges of the slabs shall be true square and free iron chipping and giving a plane surface. The thickness shall be as specified in the item.

44.2.2 Bedding for the kotah stone slabs shall be cement mortar 1:6 [1 cement : 6 coarse sand ] or L.M. 1:1.5 of thickness 20 mm as given in the description of the item. Subgrade shall be cleaned wetted and mopped. Mortar of the specified mix and thickness shall then be spread, on an area sufficient to receive one kotah stone slab. The slab shall be washed clean before laying. It shall be laid on top, pressed, tapped gently to bring it in level with the other slabs. It shall then be lifted and laid aside. Top surface of the mortar shall then be corrected by adding fresh mortar in hollows or depressions. The mortar then be allowed to harden bit. Over this surface, cement slurry of honey like consistency shall be applied. The slab shall then be gently placed in position and topped with wooden mallet till it is properly bedded in level with and close to the adjoining slab. The joint shall be as fine as possible. The slab fixed in the floor adjoining the wall shall enter not less than 10 mm. under the plaster, skirting or dedo. The junction between the wall and floor shall be finished neatly. The finished surface shall be in true levels and slopes as directed.

44.2.3 The floor shall be kept wet for a minimum period of 7 days so that bedding and joints set properly.

44.2.4 Polishing shall be normally commenced after 14 days of laying the stone slab. First polishing shall be done with carborundum stone, of 120 grade grit fitted in the heavy machine and then second polishing shall be done with carborundum stone 220 to 350 grade grit fitted in heavy machine. Water shall properly be used during polishing. The stone shall then be washed clean with water. When directed by the Engineer-in-charge wax polish of approved quality shall be applied on the surface with the help of soft cloth over clean and dry surface then the polishing machine fitted with beds shall be run over it.

44.2.5 The holes required for Nahni traps, pipes and any other fitting shall be made without extra cost.

44.3.0 Mode of Measurements & payments:-

The rate shall include the cost of all materials and labour involved in all the operations described above. The kotah stone flooring shall be measured in square metres correct to two places of decimal, length and breadth shall be measured correct to a centimeters and between the finished face of skirting dedo or mall plaster and no deduction shall be made nor extra paid for opening in floor of areas upto 0.1 Sq.Mt.



- For dedo work
- 45.1.0 Materials :  
Water shall conform to M-1. Cement mortar shall conform to M-11. Kotah stone slab shall conform to M-49.
- 45.2.0 Workmanship :  
The relevant specifications of Item No. 44 shall be followed except that the kotah stone shall be fixed for risers steps, dedo or skirting in C. M 1:5 and the polishing shall be done manually instead of machine polishing, the exposed edge of kotah stone shall be machine cut.
- 45.3.0 Mode of measurements and payment :  
The risers of steps,skirting or dedo shall be measured in sq. metre. Length shall be measured along the finished faces of risers,skirting or dedo.Height shall be measured from finished level of treads of floor to top. Lining of pillars shall be measured under this item.
- The rate shall be for a unit of one R.M.

**Detailed specifications as per Item Description.****ITEMS NO. 121:-**

Providing corrugated G.I. Sheets roofing fixed with Galvanised Iron ' J ' or ' L ' hooks bolts & nuts 8 mm.dia with bitumen & G.I. Limpet washers filled with white lead comp. excluding the cost of purlins, rafters and trusses.(i) 0.63 mm. Thick sheet (TATA or Jindal Make)

**Detailed specifications as per Item Description.****ITEMS NO. 122:-**

Supply & fixing of 16mm thick Armstrong-All RH 99 mineral fiber& Metal ceiling with 24 mm grid (local)G I frame girid consist of 600mm X 600mm tecno grid pre coated main runner 38x24x3600mm, cross T 30x24x1200mm, cross runner 24x24x600mm, wall angle 24x24mm required lenth suspension wire of 2.50mm G I & necessary hardware etc. complete aprooved by engineer in charge. For Zone-1 - Minimal risk :- waiting rooms, Technical services, Administrative office, corridors & stairways. use armstrong perforation Sheet.

**Detailed specifications as per Item Description.****ITEMS NO. 123:-**

Prov. & Fixing 600 mm x 600mm x 12mm Perforated Gypsum on wall with the property of class "0" fire propagation, random perforation of minimum perforation of 10mm and not less then 300 nos and total nos of perforation not less then 750 nos directly fitted on G I ceiling section 80 x 26 x 0.5mm with perimeter channel of 20 x 27 x 30x 0.5mm on every 600mm vertical and horizontal, wood wool board alternate panel shall be offsetted 25mm with 24 density fiber glass wool in non woven cloth bag of 35 gam preferably black in colour to achieve 0.74 NRC value, finished over to all look with jointing finishing method with glass fiber paper tapes companys branded jointing compound for crek free, smooth look and level all four side, charge perfectly brand GYPONITE / GYPTECH / INDIA GYPSUM mpa.4, hook clip:adjustable hook clip of 0.8mm th. 80 g/sq. m galvanized apring steel for 2.60 mm wire with a minimum pull of 110 kg. the adjustable clip consists of 3.5mm aquline wire toused with the main runner. 5, T - girid : super finr 15mm exposed suspension, as per design provided by the consultant market rate . use armstrong perforation Sheet.

**Detailed specifications as per Item Description.****ITEMS NO. 124:-**

Providing & fixing & making 4'0"x 4'2" x 2'3" (2 - seating) Work Space Table using pre-laminated board Drawer's make action tesa or equivalent brand ( 9mm, 11mm, 12mm, 17mm, 18mm & 25mm) . All the outer surface cover by I.S.I. brand Sunmica of Formica , silicone ,bloom green or equivalent & inner 1.5mm thick Laminate Sheet silicone or bloom or equivalent Brand.using drawer channel of Hetich brand & handle s.s. matt & drawer lock , including S.S Screws , necessary hardware etc. and Inbuilt fixing With MS Angel complete including necessary polish, hardware and labour etc. As per attached drawing & instructed by in charge Consultant

**Detailed specifications as per Item Description.****ITEMS NO. 125:-**

Providing & fixing & making 8'0" x 2'6" Size Reception Table using pre-laminated board action tesa or equivalent brand ( 9mm, 11mm, 12mm, 17mm, 18mm & 25mm) . All the outer surface cover by I.S.I. brand Sunmica of Formica , silicone ,bloom green or equivalent & inner 1.5mm thick Laminate Sheet silicone or bloom or equivalent Brand.using drawer channel of Hetich brand & handle s.s. matt & drawer lock , including S.S Screws , necessary hardware etc. and Inbuilt fixing With MS Angel complete including necessary polish, hardware and labour etc. As per attached drawing & instructed by in charge Consultant.

**Detailed specifications as per Item Description.****ITEMS NO. 126:-**

Providing & fixing & making 8'0" x 3'0" Size Executive Office Table top with pre-laminated particle board action tesa or equivalent brand ( 9mm, 11mm, 12mm, 17mm, 18mm & 25mm) of ISI marked top in action tesa brand with 2mm PVC edge beading with hot melt glue in 180° C & other edge banding 0.45mm thick. Two side Square top for superior quality table with thickness of 18mm & in other side with good quality telescopic Channel & S.S. finish handle for Drawers and doors with foot rest, 10mm tempered glass on top in table . All the outer surface cover by I.S.I. brand Sunmica of Formica , silicone ,bloom green or equivalent & inner 1.5mm





thick Laminate Sheet silicone or bloom or equivalent Brand.using drawer channel of Hetich brand & handle s.s. matt & drawer lock , including S.S Screws , necessary hardware etc. and Inbuilt fixing With MS Angel complete including necessary polish, hardware and labour etc. As per attached drawing & instructed by in charge Consultant.

**Detailed specifications as per Item Description.**

**ITEMS NO. 127:-**

Providing & fixing & making Class Room Table 8'0" x 2'0" using pre-laminated particle board action tesa or equivalent brand ( 9mm, 11mm, 12mm, 17mm, 18mm & 25mm Top with Pre-laminated particle board of ISI marked top in in action tesa brand with 2mm PVC edge beading with hot melt glue in 180°C & other edge banding 0.45 mm thick, All side square top for superior quality table with thickness of 25 mm. . All the outer surface cover by I.S.I. brand Sunmica of Formica , silicone ,bloom green or equivalent & inner 1.5mm thick Laminate Sheet silicone or bloom or equivalent Brand.using drawer channel of Hetich brand & handle s.s. matt & drawer lock , including S.S Screws , necessary hardware etc. complete including necessary polish, hardware and labour etc. As per attached drawing & instructed by in charge Consultant.

**Detailed specifications as per Item Description.**

**ITEMS NO. 128:-**

Providing & fixing & making Office Room Table 4'0" x 2'6" using pre-laminated particle board action tesa or equivalent brand ( 9mm, 11mm, 12mm, 17mm, 18mm & 25mm Top with Pre-laminated particle board of ISI marked top in in action tesa brand with 2mm PVC edge beading with hot melt glue in 180°C & other edge banding 0.45 mm thick, All side square top for superior quality table with thickness of 25 mm.. All the outer surface cover by I.S.I. brand Sunmica of Formica , silicone ,bloom green or equivalent & inner 1.5mm thick Laminate Sheet silicone or bloom or equivalent Brand.using drawer channel of Hetich brand & handle s.s. matt & drawer lock , including S.S Screws , necessary hardware etc. complete including necessary polish, hardware and labour etc. As per attached drawing & instructed by in charge Consultant.

**Detailed specifications as per Item Description.**

**ITEMS NO. 129:-**

Providing & fixing & making Meeting Room Table 6'5" x 4'3" using pre-laminated particle board action tesa or equivalent brand ( 9mm, 11mm, 12mm, 17mm, 18mm & 25mm Conference Table manufactured from high quality plb top in action tesa brand for surface & legs (25mm). . All the outer surface cover by I.S.I. brand Sunmica of Formica , silicone ,bloom green or equivalent & inner 1.5mm thick Laminate Sheet silicone or bloom or equivalent Brand.using drawer channel of Hetich brand & handle s.s. matt & drawer lock , including S.S Screws , necessary hardware etc. complete including necessary polish, hardware and labour etc. As per attached drawing & instructed by in charge Consultant.

**Detailed specifications as per Item Description.**

**ITEMS NO. 130:-**

Providing & fixing & making Canteen/Meeting Room Table 4'0" x 2'6" (Top with Pre-laminated particle board of ISI marked top in in action tesa brand with 2mm PVC edge beading with hot melt glue in 180°C & other edge banding 0.45 mm thick, All side square top for superior quality table with thickness of 25 mm.. All the outer surface cover by I.S.I. brand Sunmica of Formica , silicone ,bloom green or equivalent & inner 1.5mm thick Laminate Sheet silicone or bloom or equivalent Brand.using drawer channel of Hetich brand & handle s.s. matt & drawer lock , including S.S Screws , necessary hardware etc. complete including necessary polish, hardware and labour etc. As per attached drawing & instructed by in charge Consultant.

**Detailed specifications as per Item Description.**

**ITEMS NO. 131:-**

Providing & fixing & making STORAGE 6'0" x 3'0" x 1'6" using pre-laminated particle board action tesa or equivalent brand ( 9mm, 11mm, 12mm, 17mm, 18mm & 25mm) . All the outer surface cover by I.S.I. brand Sunmica of Formica , silicone ,bloom green or equivalent & inner 1.5mm thick Laminate Sheet silicone or bloom or equivalent Brand.using drawer channel of Hetich brand & handle s.s. matt & drawer lock , including S.S Screws , necessary hardware etc. complete including necessary polish, hardware and labour etc. As per attached drawing & instructed by in charge Consultant. near Locker Officer

**Detailed specifications as per Item Description.**

**ITEMS NO. 132:-**

Providing & fixing 12mm thick toughend glass partition with enox D-breckt fittings in this item so no extra claim for vitrified / kotah flooring .with All Border or Edge Is Polish Etc Comp.as per suggation of architect

**Detailed specifications as per Item Description.**

**ITEMS NO. 133:-**

Providing & fixing 12mm thick toughend glass railing with enox D- brecket fittings and incl. SS pipe 32 mm dia for side support with nessasry fitting include welding, lifting, placing, electric rods etc. complete welding rods to be used as per the Indian Standards. in this item so no extra claim for vitrified / kotah flooring . as per suggation of architect

**Detailed specifications as per Item Description.**



**ITEMS NO. 134:-**

Providing & fixing & making Canteen/Meeting Room Table 4'0" x 1'6" (Top with Pre-laminated particle board of ISI marked top in in action tesa brand with 2mm PVC edge beading with hot melt glue in 180°C & other edge banding 0.45 mm thick, All side square top for superior quality table with thickness of 25 mm.. All the outer surface cover by I.S.I. brand Sunmica of Formica , silicone ,bloom green or equivalent & inner 1.5mm thick Laminate Sheet silicone or bloom or equivalent Brand.using drawer channel of Hetich brand & handle s.s. matt & drawer lock , including S.S Screws , necessary hardware etc. complete including necessary polish, hardware and labour etc. As per attached drawing & instructed by in charge Consultant.

**Detailed specifications as per Item Description.**

**ITEMS NO. 135:-**

Providing & fixing & making of Auditorium Sitting using Ply (Derby,Brand Saras, Wood Stock or century sainik brand Drawer's make by 20,19,18,12,10,8 mm ply) . fixing of Australian Or Canadian pine wood for Seating & including S.S Screws , necessary hardware etc. complete including necessary with Polishing with Melamine Polish , hardware and labour etc. As per attached drawing & instructed by in charge Consultant.

**Detailed specifications as per Item Description.**

**ITEMS NO. 136:-**

Providing &Laying Wooden flooring Size 1215 x 163 mm Thickness 12 mm on polyethylene foam including skirting and All necessary fittings with flush pointing & cleaning the surface etc. comp. & Directed by Engg. In charge & Architect etc. comp.

Specifications: AC 5, Real V- groove 4 Side

Size: 1215 x 163 x 12 mm

wooden flooring product shall be tested for all sports flooring characteristics under EN norms and shall pass all criteria for things such as ball bounce, shock absorption, vertical deformation, abrasion resistance etc.

**Detailed specifications as per Item Description.**

Executive Engineer,  
SOUTH ZONE (UDHNA)  
Surat Municipal Corporation,  
SUTRAT

SIGNATURE OF THE CONTRACTOR.

**SPECIFICATION FOR ELECTRICAL INSTALLATION****SUPPLY :**

The supply mains will be brought in at places marked drawing and will be 3 Phase 50, cycles, 4 wires system 415 volts between phase and 230 volts between phase and neutral.

**SAMPLES :**

The Contractor shall submit to the Engineer-in-charge for approval samples of accessories and apparatus they (the contractor) propose to use for the installation.

The tenderer shall submit a list of important contracts carried out by them to the Engineer-in-charge.

**DRAWINGS :**

Samples to be submitted by the contractor and this specifications shall not be departed from without the instructions of the Engineer-in-charge in writing. No approval given by the Engineer-in-charge approval to any drawings or samples submitted by the contractor shall in any way exonerate the contractor from his liability out the work in accordance with the terms of this contract.

**SUPERVISION :**

The whole of the work, shall be carried out to the satisfaction of the municipal Engineer and under the constant supervision of the contractor's competent qualified and experience Electrical Engineer. The contractor shall if require, furnish the full details of the Engineer's qualification.

**GENERAL SPECIFICATIONS****1. WIRING RULES :**

The installation generally shall be carried in cinfirmy with the Indian Electricity Act/Rules and the latest edition of the wiring rules of the Installation of Elecrical Enginner (London) but where this specification differs from those rules the specifications shall be folowed.

**2. DEFINITION :**

The definition of terms the I.E.C. wiring rules shall apply.

**3. PRESSURE AND FREQUENCYN :**

The supply will be three phase 50 cycles A.C. 4 wire system 415 volts between phase, and 230 volts between phase and neutral and appratus required shall be suitable for this supply.

**4. SYSTEM OF WIRING :**

Wiring forlights, fans wall sockets, refrigerators and bells shall be carried out as described in the items and details shall be confirmed with the specification herein.

5. All iring must be done on the distribution system with main and branch distribution board at convenient centres and without isolated fuse. All conductors shall be run as far as possible so as to be easily acessible and capable of being inspected. Facility for maintance shall be particularly provided for and blancing of circuits carefully arranged.

**6. CONDUCTORS :**

All conductors shall be of copper as set for in the I.E.C. wiring rules 11th edition and no insulated conuctor shall have acrose section less than of 1/0.044 and every such conductor of greater gross section shall be standard.

**7. FALL OF POTENTIAL :**

The cross sectional area of all conductor inside the building shall be so proportioned to their lands that the drop in pressure between the main fuses and the nearest consuming appliance shall not exceed 2% with all divicer in use.

**8. CURCUITS :**

No final lighting of fan circuits from a distribution in boards shall carry more than 3 ampeares of 6 points and as far as possible the loading shall be arranged so as to obviate the necessity of using various sizes of fuse wires on sub-circuite.

**9. TESTS :**

The installation with fittings complete shall before current is switch on satisfactorily pass the following test.

(a) All the lamps and appliance having been connected to the conductors and all switches and fuses be (ON a pressure not less then twice the working pressure) (subject to a limit of 500 volts) shall be applied and the installation resistance of the whole or any part of the installation to earth must be less in megohms than 25 devided by the number of points.

**10. JOINTS :**

All joints in coductors shall be made by means of approved mechanical connector in suitable approved joints boxes but as far as possible looping back shall be adopted.

**11. SWITCHES :**

(a) All main switches shall be of quick make and break combined switch and fuse, ironclad type of reliable make and subject to approval.

(b) All branch switches controlling not more than 5 amperes shall be of quick and break, push button or tumbler pattern and shall be 'NO' when the knob is down, the attachment of covers to the base of the switch must be by means of machine screws. All fan and wall socket shall be provided with controlling switches.

**12. DISTRIBUTION BOARDS :**

All distribution boards shall be fitted with hard grain pattern Home Office Type porcelain fuses (one on positive side of circuit, the neutral being connected to a common bus bar of copper in such a way that the circuit can be easily isolated from the distribution boards) of substantial make and at least of 5/10 Amp. capacity porcelain 5 amp. round cut-outs will not be allowed to be used as fuse holder. All distribution boards shall be fitted with the wall enclosed in box of approved pattern (to be supplied by the contractor) when cancelled system is adopted and on polished folding Type Teakwood blocks with cover in the case of open wiring in each case the pattern shall be submitted to the Engineer-in-charge for approval. Load on each floor shall be distributed on required distribution boards.

**13. CEILING ROSES AND SOCKETS :**

Ceiling roses and wall sockets shall be of reliable make and subject to the approval. The subsuspension of the flexible wire for light pendants shall be so executed that the weight of the pendant will not be carried by the terminals of the ceiling rose.

**14. LAMP HOLDERS :**

Lamp holders for use on brackets shall have not less than a half inch female nipple. All cases must be solid and substantial and of bayonet pattern. Pendant lamp holder shall have a good grip fitted on them so as to carry the weight of the pendant.

**15. INTERCHANGEABILITY :**

Similar parts of all the switches, lamp holders, ceiling roses, brackets, pendants and all other fittings of the same type shall be interchangeable.

**16. CONDUIT TO BE CONTINUOUS :**

Conduit shall be of rigid P.V.C.

**17. BUNCHING OF WIRES :**

The wires of a circuit must be each together in a conduit.

**18. JOINTS IN CONDUIT :**

The lengths of conduit shall be jointed by means of adhesive solution.

**19. PRECAUTION AGAINST INSECTS AND DAMP :**

All outlets of conduit system shall be properly drained and ventilated but in such a manner as to prevent the entry of insects.

**20. PROTECTION OF CONDUIT :**

The conduits and fittings shall be joined by means of adhesive solution.

**21. CONDUCTOR :**

All conductors used in conduit wiring shall be standard conforming to I.S. 694 1988 Part -II

**22. ERECTION AND EARTHING OF CONDUIT :**

Conduit shall be electrically continuous through out and shall be permanently and efficiently connected to earth by means of solid or standard copper wire having a cross sectional area not less than that of No. 8 S.W.G. in conduit system the pipe must be continuous when passing through wall of 1 floor and earthing shall extend to the metal frame of all main and branch switches and distribution boards. Gas pipes must not be used for obtaining and earth connection.

**23. EARTH WIRE AND PLATES :**

The earthing wire and the connection with earth shall be of 8 SWG G.I. as per specified instructed by Engineer-in-charge and shall be so constructed and laid as to avoid the formation of any electronic couple. All earthing wires shall be efficiently protected against mechanical damages.

**24. PASSING THROUGH WALLS :**

The conductor shall be carried in an approved heavy gauge solid drawn or lapwelded conduit tube or porcelain the ducts. Where a wall tube passes outside a building so as to be exposed to the weather, the other end shall be bellmouthed and turned down wards.

**25. PLUGGING WALLS :**

Plugs for ordinary walls or ceiling shall be of well seasoned teak wood not less than two inches long by one inch. Square on the inner and three fourth inch square on the outer or they shall be cemented into the walls to within one fourth



inch of surfacer used with plaster or line putting to give the cement hold the plugs, two conterboards not less than half inch diameter, one inch deep must be provided on each of the two opposite sides. Iron screw may be used for attaching battens to the plugs. Where owing to IRREGULAR COURING OR OTHER REASONS THE PLUGGING OF THE WALLS IRREGULAR PRESENTS DIFFICULTIES BATTONS OR CONDUIT SHALL BE ATTACHED TO THE WALLS OR CEILING IN AMANNER APPROVED BY THE ENGINEER-IN-CHARGE.

25. ATTACHMENT TO WALLS AND CEILINGS :

In the case of lead covered or Cab-Tyre Shethed system the conductors shall be fixed on varnished teak wood battans not less than half inch in thickness by means of metal clips (of approved make) spaced at intervals of not more than 4.1/2 inches. The clips shall be fixed to T.W.battans by means of brass screws or pins set level with the surface of the clips. Pawl plug may be used for fixing battans to walls and ceiling, but only taper T.W. plugs (see clause 24) shall be used for fixing T.W. base blocks for switches regulator and ceiling rose.

26. ATTACHMENT OF FITTINGS AND ACCESSORIES :

All ceiling roses, wall socket switches, regulators, brackets, pendants and accessories attached to wall or ceiling shall be mounted on substantial teak wood varnished blocks having solid backs not less than quarter inch thicks.All accessories shall be fixed to such base blocks by means of brass screw.

27. PASSING THROUGH FLOORS :

All wires passing through floors shall be efficiently protected by means of metal or T.W. covering box extending not less than 8 fts. above floor level condit or procellain tubes shall be used for lading the wires though the floor.

28. FITTINGS :

No wire shall be buried directly in plaster.

29. FITTINGS :

Fans, regulators, lighting, fixtures etc. whether splied by the employer or conductor shall be erected in position by the contractor in such manner as not expose any unsightly fittings necessary for suspension from the ceiling or walls, and in cofirmity with the surrounding architectural design.

30. RATING :

The raing of consuming devises unless indicated on the drawings will be as follows :-

Ceiling Fans	150 Watts.
Desk fans	80 ,,
Lights	60 ,,
Wall sockets	80 ,,

31. LOCATION OF CONTROL BOARDS :

The controll boards shall be fixed in consulation with the Engineer-in-charge.

32. All makings on the switches and distribution boards shall comply with Rule 510 of Indian Electricity Act.

33. All control switches shall be located as far as possible on walls.

34. In wiring work should be used approved by I.S.I.

Executive Engineer,  
SOUTH ZONE (UDHNA)  
Surat Municipal Corporation,  
SUTRAT

SIGNATURE OF THE CONTRACTOR.

**SPECIFICATION CONCEALED CONDUIT WIRING SYSTEM**

1. All conduit used shall be completely concealed and suitable outlet boxes shall be provided to facilitate easy repairs and maintenance.
2. As far as possible the conduit system shall be so designed and erected on to obviate one use of tees, elbows and sharp bends.
3. All the conduit-system shall be thoroughly cleaned after completion of erection and before the cable is pulled in. No length of conduit shall have more than the equivalent of two quarters bends from outlet to outlet.
4. The conduit shall be of suitable cross sectional area to facilitate the pulling in of wires. In no case shall the total cross section of the wires (Measured over the insulation) be more than the half the area of the conduit bore except in short lengths of straight conduit pipe.
5. **CUTTING AWAY AND MAKING GOOD :**  
The tender is to include all necessary cutting away and making good for the purpose of the Electrical contract. The Electrical contractor will be held responsible for, and will have to make good at his own expense to the satisfaction of the Engineer-in-charge any damage to or disfigurement of the site which may have been caused by acts of Commission of himself or his servants or agents in connection of carrying out of the contract.
6. **DRAWINGS :**  
The contractor shall supply to the Engineer-in-charge a complete set wiring diagrams showing the run of concealed conduits, outlet boxes, Distribution boards, main switch etc. so as to facilitate the future maintenance of the installation.
7. **OUTLET BOXES :**  
The outlet boxes shall be of metal and so designed as to maintain the continuity of the conduit system throughout and the conduits shall be attached to the boxes either by screw joints or nuts on either side of the wall of the outlet box.
8. **SWITCHES DISTRIBUTION BOARDS ETC. :**  
The position of distribution board, fan regulators and control, switches shown in the Drawings shall be adhered to. If desired by the Engineer-in-charge the position of these shall be changed without any extra charges. The height of wall socket points, shall be fixed in consultation with the Engineer-in-charge.
9. **CABLES :**  
All cable used for wiring shall be standard and circuit wire shall be 3/029 V.I.R.
10. **MAINS :**  
All mains from service board leading up to other floors shall be in concealed conduit system.
11. **MARKING :**  
(more than 3 pin one place) be clearly marked to indicate which consuming device each controls.
12. **MAIN DISTRIBUTION BOARDS :**  
Main distribution boards for concealed wiring shall be fixed in positions flush with walls shown on the drawing and shall consist of :-
  - (a) One main switch (controlling each section).
  - (b) Hungarian type circuit fuse (1 per circuit and a common bus) control boards with switches and fan regulators shall be fixed flush with the walls and in a manner as to expose only the switch knob and fan regulators handle for operation.

**GENERAL**

1. Meters for power points and light and fan points shall be separate mains shall be brought to the position indicated on the planned line shall be taken there from to the distribution boards on various floors.
2. Electric company's charges for bringing the main cables to position indicated together with the connection for meters are payable by the owners.
3. It will be the responsibility of the contractor to get power connection from supply co. The application shall be signed by the contractor & service connection charges shall be paid by the corporation. The Corporation will not take over the installation unless power supply permanent connection is received and the entire installation is energised.
4. The contractor having electric contract licence of Gujarat State shall only be eligible to tender.

Executive Engineer,  
SOUTH ZONE (UDHNA)  
Surat Municipal Corporation,  
SURAT

SIGNATURE OF THE CONTRACTOR.

I have tendered after studying the above specification.

Signature of the Contractor :





## SPECIFICATION OF MATERIAL

## RECOMMENDED MAKE OF MATERIAL TO BE USED:

Sr. No.	Item	Make
1.	Wiring Accessories	SOR Category - II
2.	Switchgear & DB	SOR Category - III
3.	Wires and Cables	Any ISI
4.	Lift	KONE, Schindler, Otis, Mitsubishi
5.	Concealed Pipes	FIA approved and ISI
6.	Ceiling Fan	BEE (5 star rating)
7.	Glands and lugs	HMI, MCI and Dowels
8.	Pump	SOR Category-III
9.	Starter	L&T, Siemens, Cropton
10.	Lighting Items	SOR Category-III
11.	Measuring Instruments	Enercon, Meco, Rushabh
12.	Air condition	BEE (5 Star rating)
13.	Panel Fabricator/Builder	CPRI Approved only

## NOTE:

1. All the termination of distribution board and ICTP should be terminated with appropriate size lugs and glands.
2. All the material used shall be ISI and FIA approved only.
3. Make of components required to be used by contractor to complete the installation, if not mentioned anywhere, shall be required to GOT IT APPROVED by Engineer-in-charge.
4. The make of Tube, Ballast and fitting must be of same make.

Signature of the Electrical Contractor.

Date :- - -2016

**SPECIAL CONDITION**

- (1) Point wiring shall be from the distribution fuse board, No sub main shall be measured.
- (2) Samples of materials shall be given to Engineer-in-charge and approval should be taken in writing before its use.
- (3) Fabrication drawing should be get approved from the Engineer-in -charge prior to Manufacturer.
- (4) Pipe laying lay out shall be as per consultants drawings.
- (5) There shall be no junction in wiring out let box shall be used after bond.
- (6) Electrical contractor shall make good the civil work if chased or damaged.
- (7) 50% payment shall be paid to the contractor on delivery of material at site, either of bill value or item rate which is less, in case of open PVC conduit wiring.
- (8) 30% of item rate shall be paid on laying of pipes. 50 % on completion. 10% after 30 days of final take over of the installation date. 10 % shall be paid after 365 days from the date of take over of installation, in case of concealed.
- (9) Electrical Engineer-in-charge opinion shall be final and binding on contractor.
- (10) Qualified labour and supervisors shall work at site.
- (11) Electrical Contractor shall not permit unqualified labour contractor to work at site. He shall observe Govt. rules regarding control of labour. He shall submit test report and carry out tests as required and furnish detailed drawings on completion of work. The responsible authorised person by the contractor should be available of site daily when work is in progress.
- (12) The work shall be carried out during working days between 8.00 A.M. to 6.00 P.M. only. The cable trench should not remain open for more than 24 hours after excavation. If contractor intends to work on holiday or outside working hours specified, he shall take prior permission from the Engineer-in-charge. In that case overtime to the staff shall have to be paid by the Contractor. The Electrical appliance-materials shall bear the ISI mark or declaration indicating manufacturer's names and appliances material used having been manufactured in accordance with the manufacturer's certificate issued by the Government of Gujarat and confirming to the standard specified by the I.S.I. shall be given by the contractor.

The conditions laid down under House Hold Electrical appliances (Quality control Act 1981) shall be followed.

I/We agree to carry out the above work at rates indicated above at \_\_\_\_\_ percentage above/below the rates indicated above i.e. I/We agree to carry out the above work at a total cost of Rs. \_\_\_\_\_ .

The Contractor shall provide test report and get the installation approved from Govt. Elect. Authority is required.

CONTRACTORS STAMP AND SIGNATURE.



**Drawing**

- 01- LAYOUT PLAN
- 02- GROUND FLOOR PLAN
- 03- FIRST FLOOR PLAN
- 04- ELEVATION

**SURAT MUNICIPAL CORPORATION  
SOUTH ZONE (UDHNA)**

**CONSTRUCTION OF INNOVATION, INCUBATION, START UP AND TRADE FACILITATION CENTRE UNDER  
SMART CITY MISSION (PHASE-1) AT EXISTING SEPC BUILDING AT T.P. SCHEME NO.1 (UDHNA-MAJURA), F.P.  
NO.79 IN SOUTH ZONE (UDHNA), SURAT**

S.O.R 2015-2016.

<b>Incubation Centre (Part-A)</b>						
<b>(a) WORK UPTO PLINTH LEVEL</b>						
<b>ITEM NO</b>	<b>DTP NO</b>	<b>Description</b>	<b>Qty.</b>	<b>Rate</b>	<b>per</b>	<b>Amount</b>
1	1A	Excavation for foundation includ.sorting out & stacking of useful materials & disposing of the excavated stuff upto 50 mt. Lead & all lift, watering etc. Comp.				
		(A) loose or soft soil				
		( I ) Up To 1.5 mt. Depth	20.00	67.97	C.M.	1359.40
		( II ) 1.5 To 3.0 MT Depth	20.00	75.35	C.M.	1507.00
2	90	Boring holes 3.5 mt.deep in ordinary soil ( for cast in situ piles) & disposal of the surplus excavated soil as directed within a lead of 50 M. For following diameter of piles. (2) 250 mm Dia	12.00	189.48	R.M.	2273.76
3	88	Providing & laying cement concrete 1:4:8 (1 cement:4 sand:8 graded stone agg. 40 mm nominal size) & curing comp. incl.cost of form work in				
		(A) Foundation and plinth	9.00	2259.37	C.M.	20334.33
4	3	Providing & laying cement concrete 1:1.5:3 (1 cement:1.5 sand:3 graded stone agg. 20 mm nominal size)& curing comp. Includ.cost of form work but exclu. Cost of reinforcement for reinforced concrete work in :				
		(A) foundation, footing, base of columns and mass concrete	4.00	3666.06	C.M.	14664.24
5	3	Providing & laying ordinary cement con.1:1.5:3 (1cement:1.5sand: 3 graded stone agg. 20 mm nominal size) finishing smooth curing etc. comp. Includ. Cost of form work but excl. Cost of reinforcement for R.C.C. Work in : Up to G.L./P.L.				
		<b>(A) COLUMNS:</b>				
		(1) Having cross sectional area upto 0.085 upto G.L./P.L.	0.00	7810.09	C.M.	0.00
		(2) Having cross sectional area more than 0.085 and up to 0.12 sq. mt . upto G.L./P.L.	0.00	7081.88	C.M.	0.00
		(3) Having cross sectional area more than 0.12 sq. mt. upto G.L./P.L.	1.00	6229.44	C.M.	6229.44
		<b>( B ) Beam:</b>				
		(1) Having cross sectional area upto 0.08 sm. upto G.L./P.L.	0.00	6523.35	C.M.	0.00
		(2) Having cross sectional area more than 0.08 sq. mt and upto 0.12 sq.mt. upto G.L./P.L.	5.00	6052.69	C.M.	30263.45
		(3) Having cross sectional area more than 0.12 sq.mt. upto G.L./P.L.	0.00	5502.24	C.M.	0.00
		6	3A	Providing & laying ordinary cement con.1:2:4(1cement:2sand:4graded graded stone agg. 20 mm nominal size) finishing smooth curing etc. comp. Includ. Cost of form work but excl. Cost of reinforcement for R.C.C. Work in : Up to G.L./P.L. (A) COLUMNS:		
<b>(A) COLUMNS:</b>						
(1) Having cross sectional area upto 0.08 upto G.L./P.L.	1.00			7297.25	C.M.	7297.25
(2) Having cross sectional area more than 0.08 and up to 0.12 sq. mt . upto G.L./P.L.	0.00			6619.54	C.M.	0.00
(3) Having cross sectional area more than 0.12 sq. mt. upto G.L./P.L.	0.00			5767.10	C.M.	0.00

ITEM NO	DTP NO	Description	Qty.	Rate	per	Amount
7	7	Providing & fixing TMT/ CRS Bar reinforcement for R.C.C. work incl. bending, binding & placing in position etc. comp.				
		Upto G.L./P.L.	3123.00	44.84	Kg.	140035.32
8	9	Providing & construction brick work using Fly Ash bricks having crushing strength not less than 35 Kg./sq.cm. in foundation & plinth in C.M. 1:6 (1 cement:6 sand ) etc. comp. Up to G.L./P.L.				
		upto G.L./P.L.	15.00	2914.86	C.M.	43722.90
9	14	Filling in trenches with available excavated earth in layer not exceeding 20cm in depth consolidating each deposited layer by ramming & watering	35.00	79.79	C.M.	2792.65
10	13	Providing & filling in plinth with yellow soil or selected soil in layers of 20 cm. Th'. Incl. watering, ramming & consolidation etc. complete.	30.00	254.52	C.M.	7635.60
11	19	Providing & applying 20mm.th. Sand faced cement plaster on walls or similar surfaces at all floor levels consisting of 12 mm. Av. th'. backing coat of C.M. 1:3( 1 cement :3 sand) & 8 mm.th. Finishing coat of C.M.1:1 (1 cement: 1 sand)				
		upto G.L./P.L.	9.00	210.08	S.M.	1890.72
		<b>Total amount upto plinth (a)</b>				<b>280006.06</b>
		<b>(b) WORK ABOVE PLINTH LEVEL</b>				
12	5	Providing & laying ordinary cement con.1:1.5:3(1cement:1.5sand:3 graded graded stone agg. 20 mm nominal size) finishing smooth curing etc. comp. Incl. Cost of form work but excl. Cost of reinforcement for R.C.C. Work in :				
		<b>(A) Columns :</b>				
		(1) Having cros sectional area upto 0.085 sq. mt				
		Ground Floor	0.00	7810.09	C.M.	0.00
		First Floor	0.00	7844.03	C.M.	0.00
		Terrace Floor	0.00	7877.96	C.M.	0.00
		(2) Having cros sectional area more than 0.085 sq. mt and upto 0.12 sq.mt.				
		Ground Floor	1.00	7081.88	C.M.	7081.88
		First Floor	1.00	7115.81	C.M.	7115.81
		Terrace Floor	0.50	7149.75	C.M.	3574.88
		(3) Having cros sectional area more than 0.12 sq.mt.				
		Ground Floor	0.00	6229.44	C.M.	0.00
		First Floor	22.50	6263.37	C.M.	140925.83
		Terrace Floor	17.00	6297.31	C.M.	107054.27
		<b>(B) Beam:</b>				
		(1) Having cross sectional area up to 0.08 sq. mt.				
		Ground Floor	0.00	6523.35	C.M.	0.00
		First Floor	0.00	6557.28	C.M.	0.00
		Terrace Floor	0.00	6591.22	C.M.	0.00
		(2) Having cross sectional area more than 0.08 sq. mt and upto 0.12 sq.mt.				
		Ground Floor	1.00	6052.69	C.M.	6052.69
		First Floor	5.00	6086.63	C.M.	30433.15
		Terrace Floor	8.00	6120.56	C.M.	48964.48
		(3) Having cross sectional area more than 0.12 sq.mt.				
		Ground Floor	0.00	5502.24	C.M.	0.00
		First Floor	34.00	5536.18	C.M.	188230.12
		Terrace Floor	9.00	5570.11	C.M.	50130.99
		<b>(C) Slab:</b>				
		(1) Slabs having more than 8 Cm & upto 10 Cm thickness.				
		Ground Floor	0.00	5838.57	C.M.	0.00
		First Floor	0.00	5872.51	C.M.	0.00
		Terrace Floor	0.00	5906.44	C.M.	0.00
		(2) Slabs having more than 10 Cm & upto 13 Cm thickness.				



ITEM NO	DTP NO	Description	Qty.	Rate	per	Amount
		Ground Floor	1.00	5561.83	C.M.	5561.83
		First Floor	1.00	5595.77	C.M.	5595.77
		Terrace Floor	0.00	5629.70	C.M.	0.00
		(3) Slabs having more than 13 Cm thickness.				
		Ground Floor	0.00	5285.09	C.M.	0.00
		First Floor	53.00	5319.03	C.M.	281908.59
		Terrace Floor	17.00	5352.96	C.M.	91000.32
		<b>(D) Lintels:</b>				
		Ground Floor	1.00	5930.48	C.M.	5930.48
		First Floor	1.50	5964.42	C.M.	8946.63
		Terrace Floor	0.50	5998.35	C.M.	2999.18
		<b>(E) Chhajias:</b>				
		Ground Floor	0.00	3942.30	C.M.	0.00
		First Floor	10.00	3976.23	C.M.	39762.30
		Second Floor	2.50	4010.17	C.M.	10025.43
13	5	Providing & laying ordinary cement con.1:1.5:3(1cement:1.5sand:3 graded stone agg. 20 mm nominal size) finishing smooth curing etc. comp. Incl. Cost of form work but excl. Cost of reinforcement for R.C.C. Work in :				
		<b>(A) Staircases</b> including landings etc.				
		Ground Floor	0.00	4813.13	C.M.	0.00
		First Floor	4.00	4847.06	C.M.	19388.24
		<b>(B) Vertical and horizontal fins</b>				
		Ground Floor	0.00	6885.56	C.M.	0.00
		First Floor	4.50	6919.49	C.M.	31137.71
14	7	Providing & fixing TMT / CRS Bar reinforcement for R.C.C. work incl. bending, binding & placing in position etc.comp.				
		Ground Floor	620.00	44.84	Kg	27800.80
		First Floor	16985.00	45.45	Kg	771968.25
		Terrace Floor	7920.00	46.06	Kg	364795.20
15	9	Providing & construction brick work using Fly Ash bricks having crushing strength not less than 35 Kg./sq.cm. in foundation & plinth in C.M. 1:6 (1 cement:6 sand ) etc. comp. Ground Floor				
		Ground Floor	18.00	3081.51	C.M.	55467.18
		First Floor	145.00	3116.86	C.M.	451944.70
		Terrace Floor	112.00	3152.21	C.M.	353047.52
16	12	Providing & constructing Half brick masonry in Fly Ash bricks having crushing strength not less than 35 kg/sq.cm in c.m 1:4 (1 cement: 4 sand) curing etc complete.- Ground Floor				
		Ground Floor	32.00	445.41	S.M.	14253.12
		First Floor	60.00	450.36	S.M.	27021.54
		Terrace Floor	0.00	455.31	S.M.	0.00
17	15	Providing & Applying 10mm.th.cement plaster in single coat on brick/ concrete walls similar surfaces for plastering & finished even & smooth with a floating coat of cement slurry mixed with admixture of lime or neeru in required proportion etc. comp. in C.M 1:3 (1 cement : 3sand)				
		<b>(A) for wall and similar surfaces</b>				
		Ground Floor	220.00	114.13	S.M	25108.60
		First Floor	1280.00	132.01	S.M	168972.80
		Terrace Floor	525.00	149.88	S.M	78687.00
		<b>(B) for ceilings and soffits of stairs</b>				
		Ground Floor	111.00	129.89	S.M	14417.79
		First Floor	355.00	146.45	S.M	51989.75
		Terrace Floor	114.00	163.01	S.M	18583.14
18	19	Providing & Applying 20mm.th. Sand faced cement plaster on walls or similar surfaces at all floor levels consisting of 12 mm. Av. Th. backing coat of C.M. 1:3( 1 cement :3 sand) & 8 mm.th. Finishing coat of C.M.1:1 (1 cement: 1 sand)....				
		All Floor	850.00	210.08	S.M	178568.00

ITEM NO	DTP NO	Description	Qty.	Rate	per	Amount
19	20	Providing <b>35 mm wide throating or plaster drip</b> and moulding it to R. C. C. chajja etc. comp.. For all floor Market Rate.	<b>300.00</b>	25.25	R.M	<b>7575.00</b>
20	SELF EXPL.	Providing and applying 20mm. thick cement <b>plaster patta</b> of c.m. 1:3 ( 1cement : 3 sand ) etc. comp.	<b>200.00</b>	25.00	R.M	<b>5000.00</b>
		All Floors				
21	SELF EXPL.	Providing <b>20 mm deep finished groove</b> in plaster in line and level etc. Comp.	<b>240.00</b>	25.00	R.M	<b>6000.00</b>
		All Floor				
22	44	Providing & Laying <b>green polished kota stone slab flooring</b> at all floor levels,over 20 mm av.th.base of C.M. 1:6(1cement: 6 sand) laid over&joined with grey cement slurry incl. Rubbing & polishing etc. comp.	<b>194.00</b>	595.90	S.M	<b>115604.60</b>
		All Floor				
23	45	Providing & Laying polished kota stone of machine cut edge slab 22 mm. th. in riser of steps, tread, dedo & pillars center piece not less than 1.2 mt.in width &side pieces of equal size as per design, laid on 10 mm.th. C.M.1:3(1 cement:3 sand) joined & polishing etc. For all Floor	<b>0.00</b>	651.45	S.M	<b>0.00</b>
		All Floor				
24	SELF EXPL.	Providing the mirror polish to Kota flooring to give high gloss finish complete by using the silicon carbide abrasive starting from no."00" upto no."05" and then using buff/lead strips rolls tin oxide for final mirror polish as directed by Engineer-In-Charge. Rate to include all transportation and lead, lift etc.	<b>194.00</b>	110.00	S.M	<b>21340.00</b>
		All Floor				
25	97A	Providing & laying granite slab 18mm thick in flooring, treads of steps and landing laid on bed of 20mm thick cement mortar 1:6 (1 Cement : 6 coarse sand) or lime mortar 1:1.5 laid and finished with flush pointing in white or colour cement including rubbing and polishing complete. (Basic Rate:- Rs.1614.0/S.M.)	<b>63.00</b>	2374.00	S.M.	<b>149562.00</b>
		All Floor				
26	97B	Providing & laying granite slab 18mm thick in skirting, risers of steps, dedo and pillars laid on 10mm thick cement mortar 1:4 (1 Cement : 4 Coarse sand) and finished with flush pointing in white or colour cement including rubbing & polishing comp.. (Basic Rate:- Rs.1614.0/S.M.)	<b>18.00</b>	2409.00	S.M.	<b>43362.00</b>
		All Floor				
27	97B	Providing & laying granite slab 18mm thick in Window-Door seal Frame Etc laid on 10mm thick cement mortar 1:4 (1 Cement : 4 Coarse sand) with nessary adhesive material and finished with flush pointing in white or colour cement, including rubbing & polishing comp.. (Basic Rate:- Rs.1200.0/S.M.)	<b>30.00</b>	1904.00	S.M.	<b>57120.00</b>
		All Floor				
		Labour Charges For Half Round Edge For Granite	<b>261.00</b>	150.00	R.M.	<b>39150.00</b>
		Labour Charges For Quater Round Edge For Granite	<b>0.00</b>	90.00	R.M.	<b>0.00</b>
		Labour Charges For Edge Finished For Granite	<b>0.00</b>	50.00	R.M.	<b>0.00</b>
28	48A	Providing & laying 100% vitrified tile 8-10mm thick Glossy finish of Restile,Asian,Qtone,Sunheart,Tocco,Varmora make in flooring,treads of steps & Landing laid on bed of 20 mm (Average) base of cement mortar 1:6 (1 Cement : 6 Coarse sand) on new surface or fixing on existing flooring by adhesive material including dismantaling of existing flooring and jointed with colour cement slurry including finished with flush pointing & cleaning the surface etc. comp.Size 600 x 600/300 x 300 (Basic Rate:-591.80/S.M.)				

ITEM NO	DTP NO	Description	Qty.	Rate	per	Amount
			<b>58.00</b>	869.00	S.M	<b>50402.00</b>
29	47A	Providing & laying 100% vitrified tile 14-16mm thick of Restile,Asian,Qtone,Sunheart,Tocco,Varmora make in flooring,treads of steps & Landing laid on bed of 20 mm (Average) base of cement mortar 1:6 (1 Cement : 6 Coarse sand) on new surface or fixing on existing flooring by adhesive material including dismantling of existing flooring and jointed with colour cement slurry including finished with flush pointing & cleaning the surface etc. comp.Size 600 x 1200 / 800 x 800 (Basic Rate-.699.40/S.M.) (Size may be very as per architech selection or suggation)				
			<b>465.00</b>	994.00	S.M	<b>462210.00</b>
30	48B	Providing & laying 100% vitrified tile 8-10mm thick anti-skidd Original Sartin Polish Silk Type of Restile, varmora,Tocco,Asian make in skirting, risers of steps and dedo laid on 10mm thick cement mortar 1:4 (1 Cement : 4 Coarse sand) and finished with flush pointing in white or colour cement comp. or fixing on existing flooring by adhesive material including dismantling of existing flooring and jointed with colour cement slurry including finished with flush pointing & cleaning the surface etc. comp.Size 600 x 1200/600x 600 (Size may be very as per architech selection or suggation) (Basic Rate-591.80/S.M.)				
			<b>130.00</b>	955.00	S.M	<b>124150.00</b>
31	117	Providing & laying of PVC Carpet stick With fixing on existing flooring by adhesive material including finished with flush pointing & cleaning the surface etc. comp				
			<b>850.00</b>	550.00	S.M	<b>467500.00</b>
32	95A	Providing and fixing <b>FRP FRAME size 125 x 65 mm and 35 mm thick FRP shutter</b> with wood grain raised panned design finish shutter having extra reinforcement on sides & edges in Gel coat finish. The core of the shutter & frmae is to be filed up with injected polyurethene foam done in situ along with embedded wooden pieces for stiffening & also taking hinges & fixtures. The whole FRP frame & shutter is to be water proof, weather proof,termite proof & resistance to mild acid/alkali. Rates are to be inclusive of S.S.hinges with fastener sleeve & alluminium fixtures & fastenings. Product should have 3 years performance guarantee and company have ISO 9001-2000 certificate.				
		Ground Floor	<b>11.50</b>	3861.23	S.M	<b>44404.15</b>
		First Floor	<b>13.50</b>	3861.23	S.M	<b>52126.61</b>
33	25	Providing & fixing 35mm.th. Flush Door Solid Double Core type Both Face water proof Ply Vennered & 1.5 mm th.laminate shall be pasted on both side with adhesives as specified by the manufacturers. The laminate shall be as per approved shade & texture, of make incl. Sal wood frames of finished size 12cm x 7cm.incl. S.S. Hinges with nessary screws & Anodized aluminum fixtures & fastenings For all Floor				
			<b>40.00</b>	3270	S.M	<b>130800.00</b>
34	31A	Providing and fixing standared extruded of aluminium section of size 61 x 37.0 x0.90 mm (of Jindal section no.14080, @ Wt. 0.471 Kg per mt) with colour <b>powder coated</b> alluminium frame for Loveder Glass ventilation with 4 mm thick Figured glass as details etc. complete <b>for ventilation.</b>				
		(A) Same as above but <b>Colour anodized</b>	<b>6.00</b>	1800.00	S.M	<b>10800.00</b>

ITEM NO	DTP NO	Description	Qty.	Rate	per	Amount
35	98E	Providing and fixing window having extruded aluminium Powder Coated section frame main outer size 95 mm x 24 mm x 1.17 mm (of jindal section no:2459 @ Wt. of 0.738 Kg/mt), horizontal <b>Three track</b> member size 92 mm x 31.75 mm x 1.30 mm (of jindal section no:8688, @ Wt. 1.07 Kg/mt), vertical member of size 92 mm x 31.75 mm x 1.50 mm (of jindal section no:8933, @ Wt. 1.06 Kg/mt) with sliding shutters of horizontal member size 40 mm x 18 mm x 1.29 mm (of jindal section no:8947 @ wt. of 0.456 kg/mt), vertical member of size 40 mm x 18 mm x 1.29 mm (of jindal section no:8949 @ wt. of 0.456 kg/mt) with 5 mm thick transparent bronze colour tinted float glass with powder coated aluminium fittings & fixtures and transparent silicon sealant glass fixing to frame as per details etc.				
		(A) Same as above but <b>Colour anodized</b>	<b>26.00</b>	1889.71	S.M	<b>49132.46</b>
36	98D	Providing and fixing window having extruded aluminium Powder Coated section frame main outer size 63.50 x 38.10 x 1.95 mm (of Jindal section no.4605, @ Wt. 1.094Kg/mt) horizontal <b>Two track</b> member size 61.85 mm x 31.75 mm x 1.20 mm (of jindal section no:8687, @ Wt. 0.695 Kg/mt.) vertical member of size 61.85 mm x 31.75 mm x 130 mm (of jindal section no:8758 @ wt. of 0.659 kg/mt) with sliding shutters of horizontal member size 40 mm x 18 mm x 1.29 mm ( of jindal section no:8949, @ Wt. of .456 Kg/mt) vertical member of size 40 mm x 18 mm x 1.29 mm (of jindal section no:8947, @ Wt. of 0.456 Kg/mt/section 8948, @ Wt. of 0.457 Kg/mt) with 5 mm thick transparent bronze colour tinted float glass with powder coated aluminium fittings and fixtures and transparent silicon sealant glass fixing to frame as per details etc. complete for window.				
		(A) Same as above but <b>Colour anodized</b>	<b>5.00</b>	2042.22	S.M	<b>10211.10</b>
37	86	Providing & fixing in position <b>collapsible steel shutters</b> with vertical channels 20 x 10 x 2 mm. Braced with flat iron diagonals 20 x 5mm size with top & bottom rails of T-iron 40x40x6mm. with 38mm dia. steel pulleys comp. with bolts, locking arrangements, stoppers, handles incl. applying a priming coat of Redlead paint etc. comp.				
		Ground Floor	<b>5.00</b>	3723.87	S.M	<b>18619.35</b>
38	34A	Providing & fixing M.S.Grills of required pattern to wooden frames of windows etc. At all floor levels with M.S. flats at required spacing & frame around square or round bars with round headed bolts & round headed bolts and nuts or by screws incl. Priming coat of Red lead paint etc. comp. (A) Plain grill For all Floors				
		All Floor	<b>1075.00</b>	66.16	Kg.	<b>71122.00</b>
39	35	Providing & applying <b>painting two coats</b> at all floor levels on new steel other metal surface <b>with synthetic enamel paint</b> , brushing interior to give an even shade incl. cleaning the surface of all dirt, dust & other foreign matter etc. Comp. (A) For plain grill For all Floor				
		All Floor	<b>559.00</b>	45.85	S.M	<b>25632.39</b>
40	2	Providing and laying cement concrete 1: 3: 6 (1 cement : 3 coarse sand :6 graded stone aggregates 40 mm nominal size) and curing complete including cost of formwork etc. complete				
		Ground Floor	<b>0.50</b>	2510.86	CM	<b>1255.43</b>
		First Floor	<b>5.00</b>	2548.80	CM	<b>12744.00</b>
41	93B	Applying cement primer & lapi before applying colour to any new surface making surface even & smooth incl. cleaning the surface of all dirt, dust & foreign matter. (M.R.)				
		(A) for wall and similar surfaces	<b>2035.00</b>	29.00	S.M	<b>59015.00</b>
		(B) for ceilings and soffits	<b>590.00</b>	29.00	S.M	<b>17110.00</b>

ITEM NO	DTP NO	Description	Qty.	Rate	per	Amount
42	35A	Wall painting with two coats of acrylic emulsion plastic paint of approved brand over existing surface to give an even shade & surface free from mortar dropping & other foreign matter & sand papered smooth etc. comp.				
		(A) for wall and similar surfaces	2035.00	50.40	S.M	102564.00
		(B) for ceilings and soffits	590.00	50.40	S.M	29736.00
43	93A	<p>Providing &amp; applying two coats of weather shield max paint (3 coats may be required in case of darker colours.) of ICI Dulux or Apex Ultima of Asian Paint including applying exterior acrylic primer coat as per manufacturers specification and directions in shade and colour approved by architects, on exterior surfaces of the building including scaffolding, preparing the surface, watering, curing etc. complete and as directed by the architects and manufacturers.</p> <p><b>Surface Preparation :</b> surface is thoroughly clean, dry and free from all loose dirt, chalk, grease, fungi, algae and flaking paint. This can be achieved by brushing with a wire/ stiff coir brush, followed by water jetting if required. Fill up all minor cracks and defects with white cement and sand mixture in the ratio 1:3. For application on previously painted wall, previous coatings of paint must be thoroughly scraped off and Clean the surface thoroughly using wire brushes.</p> <p><b>Priming:</b> Apply a liberal coat of exterior acrylic primer and allow it to dry for 4-5 hours. Application of putty is not recommended. Minimum 4-6 hours duration is required between each coat of weather shield max paint</p>				
			859.00	74.00	S.M	63566.00
44	95	Steel work welded in built up sections, framed work including cutting, hoisting, fixing in position and applying a priming coat of red lead paint,(A) in beams & joists channels angles, tees, flats with connection plates or angle cleats as in main & cross beams,hip & trussed purlins connected to common rafter & the like.				
		All Floor	49400.00	60.89	KG.	3007966.00
45	116	Providing and fixing Stainless steel (Grade 304) railing made of Hollow Tubes,Channels, plates Polishing and making curvature (Wherever Required) and fitting the same with necessary stainless steel Bolts etc. of required size, on the top of the floor or the side of waist slab with suitable arrangement as per approval of EIC. ( For payment purpose only weight of stainless steel member shall be consider excluding fixing accessories such as nuts, bolts, fastners etc. )				
		All Floor	282.00	383.80	KG.	108231.60
46	118	Providing & Fixing Polycarbonate sheet roofing with surface of the sheet is coated with an anti-UV Co-extrusion layer having good weather resistance, it can maintain its optical properties and mechanical performance for a long time. Fasting is usually done by screws. , The fastening screws should be inserted about 500 mm apart and 300mm apart Along the supporting internal purlin and edge pulin.All fixing holes with diameter at least 2 mm larger than screw must be predrilled into each screw location. The screws should be 6mm diameter with length according to sheet thickness and corrosion resistant, with at least heavy duty hot dripped galvanized or stainless steel. Excluding the cost of purlins rafter and trusses.				
		(b) 2 mm thick Solid Sheet	173.00	1307.00	S.M	226111.00



ITEM NO	DTP NO	Description	Qty.	Rate	per	Amount
47	119	<p>Supply and fixing of KALZIP 65/400 - Self SUPPORTED" SECRET FIX STANDING ROOFING SYSTEM IN 0.9mm THICK AA 3004 ALUMINIUM ALLOY, comprising of the following layers: i. Exterior Layer -</p> <p>Top layer -Kalzip 65/400 Straight profiled sheeting manufactured from Aluminum Alloy Almm1- as specified in BS EN 1396 (comparable AA 3004), minimum material thickness of 0.9 mm and PVDF finish. The material properties are as follows:- Ultimate tensile strength: minimum 200 N/mm<sup>2</sup> 0.2% Proof Stress: minimum 185 N/mm<sup>2</sup> Modulus of elasticity:70,000 N/mm<sup>2</sup></p> <p>The fluorocarbon coating (2-coat system) shall consist of:- First coat -Inhibitive primer, with a dry film thickness averaging 5-7@m Second coat -Fluorocarbon colour coat, with a minimum dry film thickness of 20 microns. The inner side of the panels shall be finished with primer coating of 5-7 microns</p>				
		<p>Accessories, Aluminum ST clips – in grade 6061- T6 , of suitable height, with spacing as required for the wind loads. Detailed structural calculations shall be provided by the manufacturer for the Clip Pull out force. Each aluminum clip shall come with a 5mm height black polyamide thermal barrier pad. Other relevant accessories like, Ridge closures, gable end channels, tolerance clips, gable end clips, foam fillers etc to be included as appropriate and wherever necessary. Corrugation cavities shall be closed off from the outside and inside of the building to ensure a tight fit leaving no gaps</p>				
		<p>Supply and fixing of KALZIP 65/400 - Self SUPPORTED" SECRET FIX STANDING ROOFING SYSTEM IN 0.9mm THICK AA 3004 ALUMINIUM ALLOY, comprising of the following layers: i. Exterior Layer -</p> <p>Top layer -Kalzip 65/400 Straight profiled sheeting manufactured from Aluminum Alloy Almm1- as specified in BS EN 1396 (comparable AA 3004), minimum material thickness of 0.9 mm and PVDF finish. The material properties are as follows:- Ultimate tensile strength: minimum 200 N/mm<sup>2</sup> 0.2% Proof Stress: minimum 185 N/mm<sup>2</sup> Modulus of elasticity:70,000 N/mm<sup>2</sup></p> <p>The fluorocarbon coating (2-coat system) shall consist of:- First coat -Inhibitive primer, with a dry film thickness averaging 5-7@m Second coat -Fluorocarbon colour coat, with a minimum dry film thickness of 20 microns. The inner side of the panels shall be finished with primer coating of 5-7 microns</p> <p>Accessories, Aluminum ST clips – in grade 6061- T6 , of suitable height, with spacing as required for the wind loads. Detailed structural calculations shall be provided by the manufacturer for the Clip Pull out force. Each aluminum clip shall come with a 5mm height black polyamide thermal barrier pad. Other relevant accessories like, Ridge closures, gable end channels, tolerance clips, gable end clips, foam fillers etc to be included as appropriate and wherever necessary. Corrugation cavities shall</p>				
			285.00	5100.00	S.M	1453500.00
		<b>Total amount of Ground floor (b)</b>				<b>10738068.66</b>
<b>(c) WATER SUPPLY AND SANITARY ITEMS</b>						
48	53A	<p>Prov.&amp; Fixing water closet squatting pan (Orissa type W.C.pan) at all floor levels, size 580mm incl. 100 mm size "P"or "S" trap for water closet squatting pan joining the trap with the pan &amp; soil pipe in C.M. 1:1 (1cement :1 fine sand) etc. Comp.(A) Vitreous china long pattern of approved colour For all Floor</p>				
		Make- Cera, Parry ware, Jaquar ,HindWare				
		All floor	0.00	1730.00	No	0.00

ITEM NO	DTP NO	Description	Qty.	Rate	per	Amount
49	53B	Providing and fixing Wash Down Water closet European type W.C. pan with integral P or S trap with normal closing seat cover L bend ncluding jointing the trap with soil pipe in cement mortar 1:1 (1 cement : 1 find sand) (A) Viterous china pattern I				
		Make- Cera, Parry ware, Jaquar ,HindWare				
		All floor	7.00	3700.00	No	25900.00
50	53C	Providing and fixing <b>plastic seat and cover</b> for wash down water closet with C.P. brass hinges and rubber buffers (B) Black plastic seat and cover.				
		All floor	7.00	343.40	No	2403.80
51	54	Providing & fixing Wash Hung basin with single hole for pillar tap , Size- 550 x 400 x 200 mm at all floor levels, with C.I. or M.S. Brackets painted white incl. cutting holes & making good the same etc. complete. For all Floor Make- Cera, Parry ware, Jaquar				
		All floor	7.00	1370.00	No	9590.00
52	55	Providing & fixing <b>600 mm.x 450 mm. mirror</b> of superior glass at all floor levels, mounted on 6 mm. th. A.C. sheet or plywood sheet & fixed to wooden plugs with C.P.brass screws and washers etc. For all Floor				
		All floor	7.00	530.25	No	3711.75
53	54	Providing & fixing white vitreous china Urinal as per IS-2556 (Part-2 ) with C.I. hangers and 15mm dia. C.P. spreader,32mm diaWaste Coupling Full thread ,130 mm Height ,Sprinkler with Pipe and pipe to wall with C.P. flange complete including cutting and making good the walls and floors wherever required. Make- Cera, Parry ware, Jaquar	6.00	2350.00	Each	14100.00
54	80	Providing & fixing at all floor levels,both face polished machine cut edge granite slab for urinal partition joined with colour cement slurry (1:1) incl. Rubbing & polishing etc. complete. (M.R.) (Basic Rate:- Rs.1200.0/S.M.)	3.60	1800.00	S.M.	6480.00
55	56	Providing & Fixing PVC Nanhi trap 31/2" ht.of Prince/ Supreme/ Jain/ Astral/ Tulsi/Finolex make at all floor levels of self cleaning design with screwed down or hinged grating incl. cost of cutting making good the walls & floors etc. For all Floor				
		All floor	30.00	116.00	No	3480.00
56	91A	Providing & Fixing U-PVC pipe (SWR) conforming to IS no. 13592 (Type "B") of Prince/Supreme/Jain/Astral/Tulsi/Finolex make for soil and waste discharge system at all floor levels incl. All fixtures like bends, tees, shoe etc. jointed with resin of approved brand & manufacture etc. comp. (M.R.)				
		(A) 75 mm dia.	37.00	215.00	R.M	7955.00
		(B) 110 mm dia.	65.00	300.00	R.M	19500.00
57	57	Prov. & Fixing <b>S.W. Gully trap</b> with C.I.grating brick masonary (C.M 1:5)chamber & water tight Pre cast R.C.C. cover of 300mmx300mm size (inside) includ. plastering smooth inside & outside 15mm. th' in C.M.1:3 etc. comp. (i) Square mouth traps---(A) 100mm x 300mm Size -P type				
			6.00	960.26	No	5761.55

ITEM NO	DTP NO	Description	Qty.	Rate	per	Amount
58	58	Prov. & Fix. 10 cm.x15 cm.(4" x 6") S.W. trap with Inside dimension ,455 x 610 mm & 450 mm deep sewer trap chamber with 23 cm th' B.B. masonry walls in C.M 1:5 with cement plaster 15 mm th' in C.M. 1:3 inside & outside to exposed faces, R.C.C. top slab with 1:2:4 mix ( 1 cement: 2 Sand : 4 Grade stone aggregate 20mm size) ,Foundation concrete 1:5:10 & fixing Precast RCC heavy duty cover on top etc. comp. for single pipe.(A) Same as above but precast RCC heavy duty cover instead of C.I cover	4.00	2579.54	No	10318.16
59	59	Providing & construction simple chamber of 23 cm. th' B.B. Masonary in C.M 1:5 with cement plaster 15 mm th' in C.M. 1:3 inside & outside to exposed faces, R.C.C. top slab with 1:2:4 mix ( 1 cement: 2 Sand : 4 Grade stone aggregate 20mm size) ,Foundation concrete 1:5:10 & fixing Precast RCC heavy duty cover On top etc. comp. Inside dimension,455 x 610 mm &450 mm deep for single pipe (A) Same as above but precast RCC heavy duty cover instead of C.I cover	8.00	2377.54	No	19020.32
60	60	Providing, Lowering & laying joining R.C.C. NP2 CLASS Pipe In C.M. 1:1 of following nominal internal diameters incl. Testing of pipes and joints etc. Comp				
		(B) 150 mm dia.	60.00	192.91	R.M	11574.60
61	61	Providing & laying in trenches galvanised mild steel tubes(medium grade) TATA / ZENITH / ASIAN / JINDAL MAKE of the following nominal bore & tube fittings etc. comp.- 25mm.dia.				
		(A) 25 mm dia.	35.00	225.23	R.M	7883.05
62	84A	Providing & Fixing P.V.C. pipes (SCH-80) of Prince/ Supreme/ Jain/ Astral/ Tulsi/Finolex make for water supply line at all floor levels incl. fixtures like bends, tees, shoe etc joined with resin of approved brand & manufacture etc. comp. Pipe shall be fixed on the wall the help of clamp at every two meter C/C or shall be concealed as directed including necessary fittings etc. including testing of pipe and joints and fixing the same with adhesive solvent, including cost of all materials.				
		(A) 15mm. dia.	76.00	79.00	R.M	6004.00
		(B) 25mm. dia.	95.00	135.00	R.M	12825.00
		(C) 40mm. dia.	50.00	205.00	R.M	10250.00
63	63	Providing & Fixing bib tap with wall Flange at all floor levels, polished bright etc. comp.				
		Make- Cera, Parry ware, Jaquar ,HindWare				
		All floor	18.00	770.00	No	13860.00
64	63	Providing & fixing C.P. brass prass matic pillar cock with copper connection, C.P. brass screws complete				
		Make- Cera, Parry ware, Jaquar ,HindWare				
		All floor	5.00	799.00	No	3995.00
65	63	Providing and Fixing of PVC Stop Valve for UPVC line at all floor level as directed by Engr.Incharge, etc. complete.				
		(B) 25mm. dia.	6.00	237.00	No	1422.00
		(C) 40mm. dia.	2.00	415.00	No	830.00
66	65	Providing & Fixing Metropole Flush Valve with wall Flange 25mm with Lever Knob at all floor levels, of approved quality incl. fixing in pipe line etc. Comp.				
		Make- Cera, Parry ware, Jaquar ,HindWare				
		All floor	7.00	1690.00	No	11830.00
67	66	Providing & Fixing abonite ball cock of approved qualities directed etc. comp.				
		(A) 25mm. dia.	2.00	121.20	No	242.40

ITEM NO	DTP NO	Description	Qty.	Rate	per	Amount
68	91A	Providing & fixing U-PVC pipes Confirming to IS no. 13592 (Type "A") of Prince/Supreme/Jain/Astral/ Tulsi/Finolex make for rain water at all floor levels incl. fixtures like bends, tees, shoe etc joined with resin of approved brand & manufacture etc. comp. (M.R.) (A) 75 mm. Dia.				
		(B) 110mm. dia.	94.00	218.00	R.M	20492.00
69	75	Providing & fixing <b>G.I. Rain water spout</b> of 50 mm.dia & 30 cm length etc.				
		All floors level	6.00	109.08	No.	654.48
70	SELF EXPL.	Providing & fixing <b>G.I./Aluminum Patti clamps</b> at all floor levels of approved design to C.I. Or S.C.I pipes including the cost of cutting holes & making good the wall etc. Complete (M.R.)				
		(B) 100 mm Dia.	50.00	10.00	No	500.00
71	74	Providing & Fixing in position PVC Cowl vent to pipes of Prince/Supreme/Jain/Astral/Tulsi/Finolex make etc.Comp. (A) 75 mm. dia.				
		(B) 110 mm Dia.	10.00	52.00	No	520.00
72	71A	Providing & fixing <b>Z - clamps</b> at all floor levels of approved design to C.I. Or S.C.I pipes including the cost of cutting holes & making good the wall etc. Complete - 100 mm. dia. (M.R.)				
		Upto 50 mm Dia	70.00	44.00	No	3080.00
		Pipe 75 mm & 90 mm Dia.	10.00	57.00	No	570.00
		For Pipe 110 mm Dia.	50.00	72.00	No	3600.00
73	76	Providing & laying ordinary C.C.1:1.5:3 mix for R.C.C. work incl. boxing, centering, vibrating, curing & mixed with approved water proofing cement compound or "CEMWET" or "PIDICRETE LW" integral water proofing admixture as water proofing agent to be mixed with 50 kg. cement bag shall be as recommended by the manufacture of the water proofing material, concrete work for top, bottom slab & side pardi for <b>under ground Tank</b> & Item incl. Necessary excavation & refilling the available earth, 15 cm th' C.C 1:4:8 for bedding concrete, Half B.M. in C.M. 1:4 outside wall, inside R.C.C. pardi as per design, 10mm.th. water proofing cement plaster in C.M. 1:3 with smooth finishing, watering etc.Comp.to all inner face & bottom of tank curing etc. comp. incl. Locking arrangement, outlet, inlet, overflow & wash out pipe arrangement as necessary & C.I. Cover 0.60 x .045 weight not less then 35kg. etc. com. as per structural drawing excluding Steel & as directed by Engineer-in-charge				
		<b>Under Ground water Tank</b>	10000.00	4.60	Lit	46000.00
74	96C	Providing & Laying Commercial Quality white glazed tiles 6mm. th. in flooring laid on a bed of 20 mm. Av. Th.C.M.1:3(1cement :3 sand ) & on wall Of R.C.C. Tank with necessary cement paste for fixing and joined with white cement slurry etc. complete. finished with flush pointing in white cement etc.com.				
		<b>Glaze Tiles</b>	10000.00	0.90	Lit	9000.00
75	92	Providing erecting and fixing double coated <b>Syntex/Super/Reno PVC (ISI)</b> mark water tank of required capacity each with all necessary fittings & connection etc. complete on terrace.	5000.00	4.65	Lit	23250.00
76	89	<b>NOTE :-</b> (1) The whole work is to be executed through specialized agency with a guarantee of 10 (Ten) years given on a prescribed proforma duly stamped (2) The rate shall include for work at all floors & conducting water proof test as directed. (M.R.)				

ITEM NO	DTP NO	Description	Qty.	Rate	per	Amount
		(A) Providing and laying <b>water proofing treatment</b> to vertical and horizontal surfaces of depressed portions of <b>W.C.,kitchen</b> and the like consisting of : (a) I course of applying cement slurry @ 4.4 kg/sqm mixed with water proofing compound conforming to IS : 2645 in recommended proportions. (b) II course of a layer of plaster in C.M. 1:3 with water proofing compound confirming to IS:2645 about 25 mm. th' in the floor of the depression & about 18mm th' On the side walls of the depression up to the floor level, water proofing plaster about 18 mm. th' be continued on the walls above the floor level for a height of 600 mm. with surface suitable to receive further treatment (c) Finishing top with stone aggregate 10mm to 12mm nominal size spreading @0.008 C.M./S.M., thoroughly embed in plaster layer. as per specifications & instructions of Engineer in charge (Cement consumption 0.316 Bags / S.M.)				
			<b>153.00</b>	259.00	S.M.	<b>39627.00</b>
		(B) Providing and laying integral cement based <b>water proofing treatment</b> including preparation of surface as required for treatment of <b>roofs, balconies, terraces</b> etc. consisting of following operations. (a) Applying and grouting a slurry coat of neat cement using 2.75 kg/sqm of cement admixed with proprietary water proofing compound conforming to IS:2645 over the R.C.C. slab including cleaning the surface before treatment. (b) Laying cement concrete using broken bricks/brick bats 25 mm to 100 mm size with 50% of cement mortar 1:5 (1 Cement : 5 Coarse sand) admixed with proprietary water proofing compound conforming to IS:2645 ,brick bats is finally covered by jointless cement plaster 20mm th. in C.M. 1:4 added with special water proofing compound confirming to IS:2645 & top smooth finished with trowel with false chequered marking of 300 mm.size.The treatment is carried along the vertical surface of the parapet & other adjoining wall up to height of about 300 mm in a shape of quarter round vata Incl. curing etc. Comp. With average thickness of 120 mm and minimum thickness at khurra as 65 mm.				
		(c) The whole terrace so finished shall be flooded with water for a minimum period of two weeks for curing and for final test. All above operations to be down in order and as directed and specified by the engineer-in-charge. With average thickness of 120 mm and minimum thickness at khurra as 65 mm. (Cement consumption 0.511 Bags / S.M.)	<b>469.00</b>	430.00	S.M.	<b>201670.00</b>
<b>77</b>	<b>89C</b>	Providing and <b>filling</b> in depressions of Bath and W.C. At all floor levels, after completing plumbing work of pans, pipes,traps etc. <b>with cinder or fly ash</b> as directed by Engineer in charge etc. comp..	<b>23.00</b>	465.00	C.M	<b>10695.00</b>
		<b>Total amount of Plumbing &amp; Sanitation ( c )</b>				<b>568595.11</b>
		<b>(d) Demolition</b>				
<b>Item No.</b>		<b>Description</b>	<b>Qty.</b>	<b>RATE</b>	<b>UNIT</b>	<b>AMOUNT</b>
<b>78</b>	<b>105</b>	Demolition including stacking of serviceable materials and disposal of unserviceable materials with all lead and lift (ii) Unreinforced cement concrete	14.00	386.83	C.M.	<b>5415.62</b>
<b>79</b>	<b>106</b>	Demolition including stacking of serviceable materials and disposal of unserviceable materials with all lead and lift (i) RCC work	2.00	671.65	C.M.	<b>1343.30</b>
<b>80</b>	<b>107</b>	Demolition of brick work and stone masonry including stacking of serviceable materials and disposal of unserviceable materials with all lead and lift	47.00	349.46	C.M.	<b>16424.62</b>



ITEM NO	DTP NO	Description	Qty.	Rate	per	Amount
81	109	Dismantalling tiled or stone floors laid in mortar including stacking of serviceable material and disposal of unserviceable material with all lead and lift	32.00	30.30	S.M.	969.60
82	SELF EXPL.	Removing the scraping of old deteriorated plaster of any thickness from wall/R.C.C. member and disposal of unserviceable from site of work with all lead.	190.00	12.42	S.M.	2359.80
83	SELF EXPL.	<b>Re-bar process</b> ,providing supplying and fixing the rebar by making appropriate diameter of hole of minimum 150mm depth for reinforcement and cleaning the same. The standard approved (directed by engineer in charge) chemical shall be used for proper bonding.Rate shall include all lead, lift, material, labour, transportation, scaffolding, etc complete.				
		8 mm	150.00	80.00	NO.	12000.00
		10 mm	250.00	90.00	NO.	22500.00
		12 mm	200.00	125.00	NO.	25000.00
		16 mm	150.00	190.00	NO.	28500.00
		20 mm	100.00	275.00	NO.	27500.00
		25 mm	100.00	345.00	NO.	34500.00
84	SELF EXPL.	Dismantalling of R.C.C work by <b>electric breaker</b> , rate to include all lead, lift , scaffolding, transportation, and labour etc. complete. As directed by engg. Incharge.	250.00	125.00	Hr.	31250.00
		<b>Total amount of Demolition (d)</b>				207762.94
		<b>Part A -Total Amount Of Incubation Centre(a+b+c+d)</b>				11794432.77
<b>Canteen Civil Work (Part-B)</b>						
<b>(a) WORK UPTO PLINTH LEVEL</b>						
ITEM NO	SOR	Description	Qty.	Rate	per	Amount
1	1A	Excavation for foundation includ.sorting out & stacking of useful materials & disposing of the excavated stuff upto 50 mt. Lead & all lift, watering etc. Comp.				
		(A) loose or soft soil				
		( I ) Up To 1.5 mt. Depth	144.00	67.97	C.M.	9788.11
		( II ) 1.5 To 3.0 MT Depth	144.00	75.35	C.M.	10849.82
2	90	Boring holes 3.5 mt.deep in ordinary soil ( for cast in situ piles) & disposal of the surplus excavated soil as directed within a lead of 50 M. For following diameter of piles. (2) 250 mm Dia	18.00	189.48	R.M.	3410.57
3	88	Providing & laying cement concrete 1:4:8 (1 cement:4 sand:8 graded stone agg. 40 mm nominal size) & curing comp. incl.cost of form work in (A) Foundation and plinth	33.00	2259.37	C.M.	74559.21
4	3	Providing & laying cement concrete 1:1.5:3 (1 cement:1.5 sand:3 graded stone agg. 20 mm nominal size)& curing comp. Includ.cost of form work but exclu. Cost of reinforcement for reinforced concrete work in : (A) foundation, footing, base of columns and mass concrete	36.00	3666.06	C.M.	131978.26
5	3	Providing & laying ordinary cement con.1:1.5:3 (1cement:1.5sand: 3 graded stone agg. 20 mm nominal size) finishing smooth curing etc. comp. Includ. Cost of form work but excl. Cost of reinforcement for R.C.C. Work in : Up to G.L./P.L. (A) COLUMNS: (1) Having cross sectional area upto 0.085 upto G.L./P.L.	1.00	7810.09	C.M.	7810.09
		(2) Having cross sectional area more than 0.085 and up to 0.12 sq. mt . upto G.L./P.L.	0.00	7081.88	C.M.	0.00
		(3) Having cross sectional area more than 0.12 sq. mt. upto G.L./P.L.	7.50	6229.44	C.M.	46720.82
		( B ) Beam:				

ITEM NO	DTP NO	Description	Qty.	Rate	per	Amount
		(1) Having cross sectional area upto 0.08 sm. upto G.L./P.L.	0.00	6523.35	C.M.	0.00
		(2) Having cross sectional area more than 0.08 sq. mt and upto 0.12 sq.mt. upto G.L./P.L.	22.00	6052.69	C.M.	133159.24
		(3) Having cross sectional area more than 0.12 sq.mt. upto G.L./P.L.	0.00	5502.24	C.M.	0.00
6	3A	Providing & laying ordinary cement con.1:2:4(1cement:2sand:4graded graded stone agg. 20 mm nominal size) finishing smooth curing etc. comp. Includ. Cost of form work but excl. Cost of reinforcement for R.C.C. Work in : Up to G.L./P.L. (A) COLUMNS: (A) COLUMNS:				
		(1) Having cross sectional area upto 0.08 upto G.L./P.L. (Auger)	0.00	7297.25	C.M.	0.00
		(2) Having cross sectional area more than 0.08 and up to 0.12 sq. mt . upto G.L./P.L.	0.00	6619.54	C.M.	0.00
		(3) Having cross sectional area more than 0.12 sq. mt. upto G.L./P.L.	0.00	5767.10	C.M.	0.00
7	7	Providing & fixing TMT/ CRS Bar reinforcement for R.C.C. work incl. bending, binding & placing in position etc. comp. Upto G.L./P.L.	8540.00	44.84	Kg.	382967.76
8	9	Providing & construction brick work using Fly Ash bricks having crushing strength not less than 35 Kg./sq.cm. in foundation & plinth in C.M. 1:6 (1 cement:6 sand ) etc. comp. upto G.L./P.L.	18.00	2914.86	C.M.	52467.48
9	14	Filling in trenches with available excavated earth in layer not exceeding 20cm in depth consolidating each deposited layer by ramming & watering	239.00	79.79	C.M.	19069.81
10	13	Providing & filling in plinth with yellow soil or selected soil in layers of 20 cm. Th'. Incl. watering, ramming & consolidation etc. complete.	213.00	254.52	C.M.	54212.76
11	19	Providing & applying 20mm.th. Sand faced cement plaster on walls or similar surfaces at all floor levels consisting of 12 mm. Av. th'. backing coat of C.M. 1:3( 1 cement :3 sand) & 8 mm.th. Finishing coat of C.M.1:1 (1 cement: 1 sand) upto G.L./P.L.	58.00	210.08	S.M.	12184.64
		<b>Total amount upto plinth (a)</b>				<b>939178.57</b>
		<b>(b) WORK ABOVE PLINTH LEVEL</b>				
12	5	Providing & laying ordinary cement con.1:1.5:3(1cement:1.5sand:3 graded graded stone agg. 20 mm nominal size) finishing smooth curing etc. comp. Incl. Cost of form work but excl. Cost of reinforcement for R.C.C. Work in : (A) Columns :				
		(1) Having cross sectional area upto 0.085 sq. mt Ground Floor	0.00	7810.09	C.M.	0.00
		Terrace Floor	0.00	7844.03	C.M.	0.00
		(2) Having cross sectional area more than 0.085 sq. mt and upto 0.12 sq.mt. Ground Floor	0.00	7081.88	C.M.	0.00
		Terrace Floor	0.50	7115.82	C.M.	3557.91
		(3) Having cross sectional area more than 0.12 sq.mt. Ground Floor	7.50	6229.44	C.M.	46720.82
		Terrace Floor	2.50	6263.38	C.M.	15658.45
		( B ) Beam:				
		(1) Having cross sectional area up to 0.08 sq. mt. Ground Floor	0.00	6523.35	C.M.	0.00
		Terrace Floor	2.00	6557.29	C.M.	13114.58

ITEM NO	DTP NO	Description	Qty.	Rate	per	Amount
		(2) Having cross sectional area more than 0.08 sq. mt and upto 0.12 sq.mt.				
		Ground Floor	14.50	6052.69	C.M.	<b>87764.04</b>
		Terrace Floor	4.50	6086.63	C.M.	<b>27389.83</b>
		(3) Having cross sectional area more than 0.12 sq.mt.				
		Ground Floor	0.00	5502.24	C.M.	<b>0.00</b>
		Terrace Floor	0.00	5536.18	C.M.	<b>0.00</b>
		(C) Slab:				
		(1) Slabs having more than 8 Cm & upto 10 Cm thickness.				
		Ground Floor	0.00	5838.57	C.M.	<b>0.00</b>
		Terrace Floor	0.00	5872.51	C.M.	<b>0.00</b>
		(2) Slabs having more than 10 Cm & upto 13 Cm thickness.				
		Ground Floor	0.00	5561.83	C.M.	<b>0.00</b>
		Terrace Floor	0.00	5595.77	C.M.	<b>0.00</b>
		(3) Slabs having more than 13 Cm thickness.				
		Ground Floor	23.00	5285.09	C.M.	<b>121557.13</b>
		Terrace Floor	0.00	5319.03	C.M.	<b>0.00</b>
		(D) Lintels:				
		Ground Floor	1.00	5930.48	C.M.	<b>5930.48</b>
		Terrace Floor	0.00	5964.42	C.M.	<b>0.00</b>
		(E) Chhajjas:				
		Ground Floor	2.50	3942.30	C.M.	<b>9855.74</b>
		Second Floor	2.00	3976.23	C.M.	<b>7952.47</b>
<b>13</b>	<b>5</b>	Providing & laying ordinary cement con.1:1.5:3(1cement:1.5sand:3 graded graded stone agg. 20 mm nominal size) finishing smooth curing etc. comp. Incl. Cost of form work but excl. Cost of reinforcement for R.C.C. Work in :				
		(A) Staircases including landings etc.				
		Ground Floor	0.00	4813.13	C.M.	<b>0.00</b>
		(B) Vertical and horizontal fins				
		Ground Floor	3.00	6885.56	C.M.	<b>20656.68</b>
<b>14</b>	<b>7</b>	Providing & fixing TMT / CRS Bar reinforcement for R.C.C. work incl. bending, binding & placing in position etc.comp.				
		Ground Floor	7191.00	44.84	Kg	<b>322473.20</b>
		Terrace Floor	2030.00	45.45	Kg	<b>92263.50</b>
<b>15</b>	<b>9</b>	Providing & construction brick work using Fly Ash bricks having crushing strength not less than 35 Kg./sq.cm. in foundation & plinth in C.M. 1:6 (1 cement:6 sand ) etc. comp.				
		Ground Floor	38.00	3081.51	C.M.	<b>117097.38</b>
		Terrace Floor	15.00	3116.86	C.M.	<b>46752.90</b>
<b>16</b>	<b>12</b>	Providing & constructing Half brick masonry in Fly Ash bricks having crushing strength not less than 35 kg/sq.cm in c.m 1:4 (1 cement: 4 sand) curing etc complete.				
		Ground Floor	62.00	445.41	S.M.	<b>27615.42</b>
		Terrace Floor	0.00	450.36	S.M.	<b>0.00</b>
<b>17</b>	<b>15</b>	Providing & Applying 10mm.th.cement plaster in single coat on brick/ concrete walls similar surfaces for plastering & finished even & smooth with a floating coat of cement slurry mixed with admixture of lime or neeru in required proportion etc. comp. in C.M 1:3 (1 cement : 3sand)				
		(A) for wall and similar surfaces				
		Ground Floor	314.00	114.13	S.M	<b>35836.82</b>
		Terrace Floor	64.00	132.01	S.M	<b>8448.45</b>
		(B) for ceilings and soffits of stairs				
		Ground Floor	240.00	129.89	S.M	<b>31172.64</b>
		Terrace Floor	0.00	146.45	S.M	<b>0.00</b>

ITEM NO	DTP NO	Description	Qty.	Rate	per	Amount
18	19	Providing & Applying 20mm.th. Sand faced cement plaster on walls or similar surfaces at all floor levels consisting of 12 mm. Av. Th. backing coat of C.M. 1:3( 1 cement :3 sand) & 8 mm.th. Finishing coat of C.M.1:1 (1 cement: 1 sand)....				
		All Floor	380.00	210.08	S.M	79830.40
19	20	Providing 35 mm wide throating or plaster drip and moulding it to R. C. C. chajja etc. comp.. For all floor Market Rate.	50.00	25.25	R.M	1262.50
20	SELF EXPL.	Providing and applying 20mm. thick cement plaster patta of c.m. 1:3 ( 1cement : 3 sand ) etc. comp.				
		All Floors	50.00	25.00	R.M	1250.00
21	SELF EXPL.	Providing 20 mm deep finished groove in plaster in line and level etc. Comp.				
		All Floor	50.00	25.00	R.M	1250.00
22	44	Providing & Laying green polished kota stone slab flooring at all floor levels,over 20 mm av.th.base of C.M. 1:6(1cement: 6 sand) laid over&joined with grey cement slurry incl. Rubbing & polishing etc. comp. (A) 22 mm. (Tolerance + / - 2 mm) For all floor				
		All Floor	0.00	595.90	S.M	0.00
23	45	Providing & Laying polished kota stone of machine cut edge slab 22 mm. th. in riser of steps, tread, dedo & pillars center piece not less than 1.2 mt.in width &side pieces of equal size as per design, laid on 10 mm.th. C.M.1:3(1 cement:3 sand) joined & polishing etc. For all Floor				
		All Floor	0.00	651.45	S.M	0.00
24	SELF EXPL.	Providing the mirror polish to Kota flooring to give high gloss finish complete by using the silicon carbide abrasive starting from no."00" upto no."05" and then using buff/lead strips rolls tin oxide for final mirror polish as directed by Engineer-In-Charge. Rate to include all transportation and lead, lift etc.				
		All Floor	0.00	110.00	S.M	0.00
25	97A	Providing & laying granite slab 18mm thick in flooring, treads of steps and landing laid on bed of 20mm thick cement mortar 1:6 (1 Cement : 6 coarse sand) or lime mortar 1:1.5 laid and finished with flush pointing in white or colour cement including rubbing and polishing complete. (Basic Rate:- Rs.1614.0/S.M.)				
		All Floor	23.00	2374.00	S.M.	54602.00
26	97A	Providing & laying granite slab 18mm thick in skirting, risers of steps, dedo and pillars laid on 10mm thick cement mortar 1:4 (1 Cement : 4 Coarse sand) and finished with flush pointing in white or colour cement including rubbing & polishing comp.. (Basic Rate:- Rs.1614.0/S.M.)				
		All Floor	5.00	2409.00	S.M.	12045.00
27	97B	Providing & laying granite slab 18mm thick in Window-Door seal Frame Etc laid on 10mm thick cement mortar 1:4 (1 Cement : 4 Coarse sand) with nessary adhesive material and finished with flush pointing in white or colour cement, including rubbing & polishing comp.. (Basic Rate:- Rs.1200.0/S.M.)				
		All Floor	37.00	1904.00	S.M.	70448.00
		Labour Charges For Half Round Edge For Granite	266.00	150.00	R.M.	39900.00
		Labour Charges For Quater Round Edge For Granite	0.00	90.00	R.M.	0.00
		Labour Charges For Edge Finished For Granite	0.00	50.00	R.M.	0.00

ITEM NO	DTP NO	Description	Qty.	Rate	per	Amount
28	48A	Providing & laying 100% vitrified tile 8-10mm thick Glossy finish of Restile,Asian,Qtone,Sunheart,Tocco,Varmora make in flooring,treads of steps & Landing laid on bed of 20 mm (Average) base of cement mortar 1:6 (1 Cement : 6 Coarse sand) on new surface or fixing on existing flooring by adhesive material including dismantling of existing flooring and jointed with colour cement slurry including finished with flush pointing & cleaning the surface etc. comp.Size 600 x 600/300 x 300 (Basic Rate-.591.80/S.M.)				
			70.00	869.00	S.M	60830.00
29	47A	Providing & laying 100% vitrified tile 14-16mm thick of Restile,Asian,Qtone,Sunheart,Tocco,Varmora make in flooring,treads of steps & Landing laid on bed of 20 mm (Average) base of cement mortar 1:6 (1 Cement : 6 Coarse sand) on new surface or fixing on existing flooring by adhesive material including dismantling of existing flooring and jointed with colour cement slurry including finished with flush pointing & cleaning the surface etc. comp.Size 600 x 1200 / 800 x 800 (Basic Rate-.699.40/S.M.) (Size may be very as per architech selection or suggation)				
			150.00	994.00	S.M	149100.00
30	48B	Providing & laying 100% vitrified tile 8-10mm thick anti-skidd Original Sartin Polish Silk Type of Restile, varmora,Tocco,Asian make in skirting, risers of steps and dedo laid on 10mm thick cement mortar 1:4 (1 Cement : 4 Coarse sand) and finished with flush pointing in white or colour cement comp. or fixing on existing flooring by adhesive material including dismantling of existing flooring and jointed with colour cement slurry including finished with flush pointing & cleaning the surface etc. comp.Size 600 x 1200/600x 600 (Size may be very as per architech selection or suggation) (Basic Rate-591.80/S.M.)				
			236.00	955.00	S.M	225380.00
31	95A	Providing and fixing FRP FRAME size 125 x 65 mm and 35 mm thick FRP shutter with wood grain raised panneled design finish shutter having extra reinforcement on sides & edges in Gel coat finish. The core of the shutter & frmae is to be filed up with injected polyurethene foam done in situ along with embedded wooden pieces for stiffening & also taking hinges & fixtures. The whole FRP frame & shutter is to be water proof, weather proof,termite proof & resistance to mild acid/alkali. Rates are to be inclusive of S.S.hinges with fastener sleeve & alluminium fixtures & fastentings. Product should have 3 years performance guarantee and company have ISO 9001-2000 certificate.				
		Ground Floor	3.50	3861.23	S.M	13514.31
32	25	Providing & fixing 35mm.th. Flush Door Solid Double Core type Both Face water proof Ply Vennered & 1.5 mm th.laminate shall be pasted on both side with adhesives as specified by the manufacturers. The laminate shall be as per approved shade & texture, of make incl. Sal wood frames of finished size 12cm x 7cm.incl. S.S. Hinges with nessary screws & Anodized aluminum fixtures & fastenings For all Floor				
			28.00	3270.00	S.M	91560.00
33	31A	Providing and fixing standared extruded of aluminium section of size 61 x 37.0 x0.90 mm (of Jindal section no.14080, @ Wt. 0.471 Kg per mt) with colour powder coated alluminium frame for Loveded Glass ventilation with 4 mm thick Figured glass as details etc. complete for ventilation.				



ITEM NO	DTP NO	Description	Qty.	Rate	per	Amount
		(A) Same as above but Colour anodized	1.00	1800.00	S.M	<b>1800.00</b>
34	98E	Providing and fixing window having extruded aluminium Powder Coated section frame main outer size 95 mm x 24 mm x 1.17 mm (of jindal section no:2459 @ Wt. of 0.738 Kg/mt), horizontal Three track member size 92 mm x 31.75 mm x 1.30 mm (of jindal section no:8688, @ Wt. 1.07 Kg/mt), vertical member of size 92 mm x 31.75 mm x 1.50 mm (of jindal section no:8933, @ Wt. 1.06 Kg/mt) with sliding shutters of horizontal member size 40 mm x 18 mm x 1.29 mm (of jindal section no:8947 @ wt. of 0.456 kg/mt), vertical member of size 40 mm x 18 mm x 1.29 mm (of jindal section no:8949 @ wt. of 0.456 kg/mt) with 5 mm thick transparent bronze colour tinted float glass with powder coated aluminium fittings & fixtures and transparent silicon sealant glass fixing to frame as per details etc.				
		(A) Same as above but Colour anodized	15.00	1889.71	S.M	<b>28345.65</b>
35	98D	Providing and fixing window having extruded aluminium Powder Coated section frame main outer size 63.50 x 38.10 x 1.95 mm (of Jindal section no.4605, @ Wt. 1.094Kg/mt) horizontal Two track member size 61.85 mm x 31.75 mm x 1.20 mm (of jindal section no:8687, @ Wt. 0.695 Kg/mt.) vertical member of size 61.85 mm x 31.75 mm x 130 mm (of jindal section no:8758 @ wt. of 0.659 kg/mt) with sliding shutters of horizontal member size 40 mm x 18 mm x 1.29 mm (of jindal section no:8949, @ Wt. of .456 Kg/mt) vertical member of size 40 mm x 18 mm x 1.29 mm (of jindal section no:8947, @ Wt. of 0.456 Kg/mt/section 8948, @ Wt. of 0.457 Kg/mt) with 5 mm thick transparent bronze colour tinted float glass with powder coated aluminium fittings and fixtures and transparent silicon sealant glass fixing to frame as per details etc. complete for window.				
		(A) Same as above but Colour anodized	18.00	2042.22	S.M	<b>36759.96</b>
36	98D	Providing and fixing standared extruded of aluminium section of size 61 x 37.0 x 0.90 mm (of Jindal section no.14080, @ Wt. 0.471 Kg per mt) with Powder Coated alluminium frame with 5 mm thick transparent bronze colour tinted float glass as details etc. complete for fix window.				
		(A) Same as above but Colour anodized	0.00	1525.00	S.M	<b>0.00</b>
37	86	Providing & fixing in position collapsible steel shutters with vertical channels 20 x 10 x 2 mm. Braced with flat iron diagonals 20 x 5mm size with top & bottom rails of T-iron 40x40x6mm. with 38mm dia. steel pulleys comp. with bolts, locking arrangements, stoppers, handles incl. applying a priming coat of Redlead paint etc. comp.				
		Ground Floor	11.00	3723.87	S.M	<b>40962.57</b>
38	34A	Providing & fixing M.S.Grills of required pattern to wooden frames of windows etc. At all floor levels with M.S. flats at required spacing & frame around square or round bars with round headed bolts & round headed bolts and nuts or by screws incl. Priming coat of Red lead paint etc. comp. (A) Plain grill For all Floors				
		All Floor	850.00	66.16	Kg.	<b>56236.00</b>
39	35	Providing & applying painting two coats at all floor levels on new steel other metal surface with synthetic enamel paint, brushing interior to give an even shade incl. cleaning the surface of all dirt, dust & other foreign matter etc. Comp. (A) For plain grill For all Floor				
		All Floor	150.00	45.85	S.M	<b>6878.10</b>
40	2	Providing and laying cement concrete 1: 3: 6 (1 cement : 3 coarse sand :6 graded stone aggregates 40 mm nominal size) and curing complete including cost of formwork etc. complete				

ITEM NO	DTP NO	Description	Qty.	Rate	per	Amount
		Ground Floor	1.50	2510.86	CM	<b>3766.29</b>
41	93B	Applying cement primer & lapi before applying colour to any new surface making surface even & smooth incl. cleaning the surface of all dirt, dust & foreign matter. (M.R.)				
		(A) for wall and similar surfaces	383.00	29.00	S.M	<b>11107.00</b>
		(B) for ceilings and soffits	245.00	29.00	S.M	<b>7105.00</b>
42	35A	Wall painting with two coats of acrylic emulsion plastic paint of approved brand over existing surface to give an even shade & surface free from mortar dropping & other foreign matter & sand papered smooth etc. comp.				
		(A) for wall and similar surfaces	380.00	50.40	S.M	<b>19151.62</b>
		(B) for ceilings and soffits	245.00	50.40	S.M	<b>12347.76</b>
43	93A	Providing & applying two coats of weather shield max paint (3 coats may be required in case of darker colours.)of ICI Dulux or Apex Ultima of Asian Paint including applying exterior acrylic primer coat as per manufacturers specification and directions in shade and colour approved by architects, on exterior surfaces of the building including scaffolding, preparing the surface, watering, curing etc. complete and as directed by the architects and manufacturers. Surface Preparation : surface is thoroughly clean, dry and free from all loose dirt, chalk, grease, fungi, algae and flaking paint. This can be achieved by brushing with a wire/ stiff coir brush, followed by water jetting if required. Fill up all minor cracks and defects with white cement and sand mixture in the ratio 1:3. For application on previously painted wall, previous coatings of paint must be thoroughly scraped off and Clean the surface thoroughly using wire brushes. Priming: Apply a liberal coat of exterior acrylic primer and allow it to dry for 4-5 hours. Application of putty is not recommended. Minimum 4-6 hours duration is required between each coat of weather shield max paint				
			438.00	74.00	S.M	<b>32412.00</b>
44	95	Steel work welded in built up sections, framed work including cutting, hoisting, fixing in position and applying a priming coat of red lead paint,(A) in beams & joists channels angles, tees, flats with connection plates or angle cleats as in main & cross beams,hip & trussed purlins connected to common rafter & the like.				
		All Floor	3105.00	60.89	KG.	<b>189072.45</b>
45	116	Providing and fixing Staainless steel (Garde 304) railling made of Hollow Tubes,Channels, plates Polising and making curvature (Wherever Required) and fitting the same with necessary stainless steel Bolts etc. of required size, on the top of the floor or the side of waist slab with suitable arrangement as per approval of EIC. ( For payment perpose only weight of stainless steel member shall be consider excluding fixing accessories such as nuts, bolts, fastners etc. )				
		All Floor	108.00	383.80	KG.	<b>41450.40</b>
46	120	Providing and laying kitchen platform of width 75cm with top 16mm Thick 100% Vitrified platform 800 x 2400 mm flooring, treads of steps & landing laid on a bed of 12 mm thick C.M. 1:6 (1 Cement : 6 Coarse sand ) Finished with flush pointing in white or colour cement. with bottom of polish kotastone including front side100mm facia patti (horizontal)of polish granite including req. partition support of double side polished Kota				
		All Floor	30.00	1573.00	RM	<b>47190.00</b>

ITEM NO	DTP NO	Description	Qty.	Rate	per	Amount
47	115	The glazing has to be done using semi-unitized system. The main frames both verticals and horizontals have to be pipes of 64mm x 38 mm of 2.9 mm thick and sub frame of size 25mm x 50mm 1.6mm thick all colour anodized of 15 microns. The glass shall be glaverbel 5mm to 6mm toughened super silver grey or. equivalent The glass shall shall be stuck to the sub-frame with.Norton or equivalent tape as spacer and Dow Corning 995 as silicon. The silicon manufacture has approve the same. Later the grooves shall be fillrd with Dow Corning 789.The hardware used shall be aluminum or hot - dip galvanized. Water penetration testing has to be done on site.	0.00	4224.00	S.M	0.00
48	121	Providing corrugated G.I. Sheets roofing fixed with Galvanised Iron ' J ' or ' L' hooks bolts & nuts 8 mm.dia with bitumen & G.I. Limpet washers filled with white lead comp. excluding the cost of purlins, rafters and trusses.(i) 0.63 mm. Thick sheet (TATA or Jindal Make)	132.00	594.00	S.M	78408.00
<b>Total amount of Above Plinth (b)</b>						<b>2455783.45</b>
<b>(c) WATER SUPPLY AND SANITARY ITEMS</b>						
49	53A	Prov.& Fixing water closet squatting pan (Orissa type W.C.pan) at all floor levels, size 580mm incl. 100 mm size "Por "S" trap for water closet squatting pan joining the trap with the pan & soil pipe in C.M. 1:1 (1cement :1 fine sand) etc. Comp.(A) Vitreous china long pattern of approved colour For all Floor				
		Make- Cera, Parry ware, Jaquar ,HindWare				
		All floor	0.00	1730.00	No	0.00
50	53B	Providing and fixing Wash Down Water closet European type W.C. pan with integral P or S trap with normal closing seat cover L bend ncluding jointing the trap with soil pipe in cement mortar 1:1 (1 cement : 1 find sand) (A) Viterous china pattern I				
		Make- Cera, Parry ware, Jaquar ,HindWare				
		All floor	2.00	3700.00	No	7400.00
51	53C	Providing and fixing plastic seat and cover for wash down water closet with C.P. brass hinges and rubber buffers (B) Black plastic seat and cover.				
		All floor	2.00	343.40	No	686.80
52	54	Providing & fixing Wash Hung basin with single hole for pillar tap , Size- 550 x 400 x 200 mm at all floor levels, with C.I. or M.S. Brackets painted white incl. cutting holes & making good the same etc. complete. For all Floor Make- Cera, Parry ware, Jaquar				
		All floor	4.00	1370.00	No	5480.00
53	55	Providing & fixing 600 mm.x 450 mm. mirror of superior glass at all floor levels, mounted on 6 mm. th. A.C. sheet or plywood sheet & fixed to wooden plugs with C.P.brass screws and washers etc. For all Floor				
		All floor	4.00	530.25	No	2121.00
54	54	Providing & fixing white vitreous china Urinal as per IS-2556 (Part-2 ) with C.I. hangers and 15mm dia. C.P. spreader,32mm diaWaste Coupling Full thread ,130 mm Height ,Sprinkler with Pipe and pipe to wall with C.P. flange complete including cutting and making good the walls and floors wherever required. Make- Cera, Parry ware, Jaquar	2.00	2350.00	Each	4700.00

ITEM NO	DTP NO	Description	Qty.	Rate	per	Amount
55	56	Providing & Fixing PVC Nanhi trap 31/2" ht.of Prince/Supreme/ Jain/ Astral/ Tuls/Finolex make at all floor levels of self cleaning design with screwed down or hinged grating incl. cost of cutting making good the walls & floors etc. For all Floor				
		All floor	8.00	116.00	No	928.00
56	91A	Providing & Fixing U-PVC pipe (SWR) conforming to IS no. 13592 (Type "B") of Prince/Supreme/Jain/Astral/Tuls/Finolex make for soil and waste discharge system at all floor levels incl. All fixtures like bends, tees, shoe etc. jointed with resin of approved brand & manufacture etc. comp. (M.R.)				
		(A) 75 mm dia.	10.00	215.00	R.M	2150.00
		(B) 110 mm dia.	26.00	300.00	R.M	7800.00
57	57	Prov. & Fixing S.W. Gully trap with C.I.grating brick masonry (C.M 1:5)chamber & water tight Pre cast R.C.C. cover of 300mmx300mm size (inside) includ. plastering smooth inside & outside 15mm. th' in C.M.1:3 etc. comp. (i) Square mouth traps---(A) 100mm x 300mm Size -P type				
			3.00	960.26	No	2880.77
58	58	Prov. & Fix. 10 cm.x15 cm.(4" x 6") S.W. trap with Inside dimension ,455 x 610 mm & 450 mm deep sewer trap chamber with 23 cm th' B.B. masonry walls in C.M 1:5 with cement plaster 15 mm th' in C.M. 1:3 inside & outside to exposed faces, R.C.C. top slab with 1:2:4 mix ( 1 cement: 2 Sand : 4 Grade stone aggregate 20mm size) ,Foundation concrete 1:5:10 & fixing Precast RCC heavy duty cover on top etc. comp. for single pipe.(A) Same as above but precast RCC heavy duty cover instead of C.I cover				
			2.00	2579.54	No	5159.08
59	59	Providing & construction simple chamber of 23 cm. th' B.B. Masonary in C.M 1:5 with cement plaster 15 mm th' in C.M. 1:3 inside & outside to exposed faces, R.C.C. top slab with 1:2:4 mix ( 1 cement: 2 Sand : 4 Grade stone aggregate 20mm size) ,Foundation concrete 1:5:10 & fixing Precast RCC heavy duty cover On top etc. comp. Inside dimension,455 x 610 mm &450 mm deep for single pipe (A) Same as above but precast RCC heavy duty cover instead of C.I cover				
			5.00	2377.54	No	11887.70
60	60	Providing, Lowering & laying joining R.C.C. NP2 CLASS Pipe In C.M. 1:1 of following nominal internal diameters incl. Testing of pipes and joints etc. Comp				
		(B) 150 mm dia.	30.00	192.91	R.M	5787.30
61	61	Providing & laying in trenches galvanised mild steel tubes(medium grade) TATA / ZENITH / ASIAN / JINDAL MAKE of the following nominal bore & tube fittings etc. comp.- 25mm.dia.				
		(A) 25 mm dia.	30.00	225.23	R.M	6756.90
62	84A	Providing & Fixing P.V.C. pipes (SCH-80) of Prince/Supreme/ Jain/ Astral/ Tuls/Finolex make for water supply line at all floor levels incl. fixtures like bends, tees, shoe etc jointed with resin of approved brand & manufacture etc. comp. Pipe shall be fixed on the wall the help of clamp at every two meter C/C or shall be concealed as directed including necessary fittings etc. including testing of pipe and joints and fixing the same with adhesive solvent, including cost of all materials.				
		(A) 15mm. dia.	33.00	79.00	R.M	2607.00
		(B) 25mm. dia.	34.00	135.00	R.M	4590.00
		(C) 40mm. dia.	10.00	205.00	R.M	2050.00
63	63	Providing & Fixing bib tap with wall Flange at all floor levels, polished bright etc. comp.				

ITEM NO	DTP NO	Description	Qty.	Rate	per	Amount
		Make- Cera, Parry ware, Jaquar ,HindWare				
		All floor	8.00	770.00	No	<b>6160.00</b>
<b>64</b>	63	Providing & fixing C.P. brass prass matic pillar cock with copper connection, C.P. brass screws complete				
		Make- Cera, Parry ware, Jaquar ,HindWare				
		All floor	4.00	799.00	No	<b>3196.00</b>
<b>65</b>	<b>SELF EXPL.</b>	Providing and Fixing of PVC Stop Valve for UPVC line at all floor level as directed by Engr.Incharge, etc. complete.				
		(B) 25mm. dia.	4.00	237.00	No	<b>948.00</b>
		(C) 40mm. dia.	1.00	415.00	No	<b>415.00</b>
<b>66</b>	65	Providing & Fixing Metropole Flush Valve with wall Flange 25mm with Lever Knob at all floor levels, of approved quality incl. fixing in pipe line etc. Comp.				
		Make- Cera, Parry ware, Jaquar ,HindWare				
		All floor	2.00	1690.00	No	<b>3380.00</b>
<b>67</b>	<b>66</b>	Providing & Fixing abonite ball cock of approved qualities directed etc. comp.				
		(A) 25mm. dia.	2.00	121.20	No	<b>242.40</b>
<b>68</b>	<b>91A</b>	Providing & fixing U-PVC pipes Confirming to IS no. 13592 (Type "A") of Prince/Supreme/Jain/Astral/ Tulsi/Finolex make for rain water at all floor levels incl. fixtures like bends, tees, shoe etc joined with resin of approved brand & manufacture etc. comp. (M.R.) (A) 75 mm. Dia.				
		(B) 110mm. dia.	28.00	218.00	R.M	<b>6104.00</b>
<b>69</b>	<b>75</b>	Providing & fixing G.I. Rain water spout of 50 mm.dia & 30 cm length etc.				
		All floors level	2.00	109.08	No.	<b>218.16</b>
<b>70</b>	<b>SELF EXPL.</b>	Providing & fixing G.I./Aluminum Patti clamps at all floor levels of approved design to C.I. Or S.C.I pipes including the cost of cutting holes & making good the wall etc. Complete (M.R.)				
		(B) 100 mm Dia.	10.00	10.00	No	<b>100.00</b>
<b>71</b>	<b>74</b>	Providing & Fixing in position PVC Cowl vent to pipes of Prince/Supreme/Jain/Astral/Tulsi/Finolex make etc.Comp. (A) 75 mm. dia.				
		(B) 110 mm Dia.	2.00	52.00	No	<b>104.00</b>
<b>72</b>	<b>71-A</b>	Providing & fixing Z - clamps at all floor levels of approved design to C.I. Or S.C.I pipes including the cost of cutting holes & making good the wall etc. Complete - 100 mm. dia. (M.R.)				
		Upto 50 mm Dia	20.00	44.00	No	<b>880.00</b>
		Pipe 75 mm & 90 mm Dia.	5.00	57.00	No	<b>285.00</b>
		For Pipe 110 mm Dia.	35.00	72.00	No	<b>2520.00</b>

ITEM NO	DTP NO	Description	Qty.	Rate	per	Amount
73	76	Providing & laying ordinary C.C.1:1.5:3 mix for R.C.C. work incl. boxing, centering, vibrating, curing & mixed with approved water proofing cement compound or "CEMWET" or "PIDICRETE LW" integral water proofing admixture as water proofing agent to be mixed with 50 kg. cement bag shall be as recommended by the manufacture of the water proofing material, concrete work for top, bottom slab & side pardi for under ground Tank & Item incl. Necessary excavation & refilling the available earth, 15 cm th' C.C 1:4:8 for bedding concrete, Half B.M. in C.M. 1:4 outside wall, inside R.C.C. pardi as per design, 10mm.th. water proofing cement plaster in C.M. 1:3 with smooth finishing, watering etc. Comp. to all inner face & bottom of tank curing etc. comp. incl. Locking arrangement, outlet, inlet, overflow & wash out pipe arrangement as necessary & C.I. Cover 0.60 x .045 weight not less than 35kg. etc. com. as per structural drawing excluding Steel & as directed by Engineer-in-charge				
		Under Ground water Tank	5000.00	4.60	Lit	22977.50
74	96C	Providing & Laying Commercial Quality white glazed tiles 6mm. th. in flooring laid on a bed of 20 mm. Av. Th.C.M.1:3(1cement :3 sand ) & on wall Of R.C.C. Tank with necessary cement paste for fixing and joined with white cement slurry etc. complete. finished with flush pointing in white cement etc.com.				
		Glaze Tiles	5000.00	0.90	Lit	4500.00
75	92	Providing erecting and fixing double coated Syntex/Super/Reno PVC (ISI) mark water tank of required capacity each with all necessary fittings & connection etc. complete on terrace.	2000.00	4.65	Lit	9300.00
76	89	NOTE :- (1) The whole work is to be executed through specialized agency with a guarantee of 10 (Ten) years given on a prescribed proforma duly stamped (2) The rate shall include for work at all floors & conducting water proof test as directed. (M.R.)				
		(A) Providing and laying water proofing treatment to vertical and horizontal surfaces of depressed portions of W.C., kitchen and the like consisting of : (a) I course of applying cement slurry @ 4.4 kg/sqm mixed with water proofing compound conforming to IS : 2645 in recommended proportions. (b) II course of a layer of plaster in C.M. 1:3 with water proofing compound confirming to IS:2645 about 25 mm. th' in the floor of the depression & about 18mm th' On the side walls of the depression up to the floor level, water proofing plaster about 18 mm. th' be continued on the walls above the floor level for a height of 600 mm. with surface suitable to receive further treatment (c) Finishing top with stone aggregate 10mm to 12mm nominal size spreading @0.008 C.M./S.M., thoroughly embedad in plaster layer. as per specifications & instructions of Engineer in charge (Cement consumption 0.316 Bags / S.M.)	28.00	259.00	S.M.	7252.00



ITEM NO	DTP NO	Description	Qty.	Rate	per	Amount
		(B) Providing and laying integral cement based water proofing treatment including preparation of surface as required for treatment of roofs, balconies, terraces etc. consisting of following operations. (a) Applying and grouting a slurry coat of neat cement using 2.75 kg/sqm of cement admixed with proprietary water proofing compound conforming to IS:2645 over the R.C.C. slab including cleaning the surface before treatment. (b) Laying cement concrete using broken bricks/brick bats 25 mm to 100 mm size with 50% of cement mortar 1:5 (1 Cement : 5 Coarse sand) admixed with proprietary water proofing compound conforming to IS:2645 ,brick bats is finally covered by jointless cement plaster 20mm th. in C.M. 1:4 added with special water proofing compound confirming to IS:2645 & top smooth finished with trowel with false chequered marking of 300 mm.size.The treatment is carried along the vertical surface of the parapet & other adjoining wall up to height of about 300 mm in a shape of quarter round vata Incl. curing etc. Comp. With average thickness of 120 mm and minimum thickness at khurra as 65 mm.				
		(c) The whole terrace so finished shall be flooded with water for a minimum period of two weeks for curing and for final test. All above operations to be down in order and as directed and specified by the engineer-in-charge. With average thickness of 120 mm and minimum thickness at khurra as 65 mm. (Cement consumption 0.511 Bags / S.M.)	235.00	430.00	S.M.	101050.00
77	89C	Providing and filling in depressions of Bath and W.C. At all floor levels, after completing plumbing work of pans, pipes,traps etc.with cinder or fly ash as directed by Engineer in charge etc. comp..	0.00	465.00	C.M	0.00
		Total amount of Plumbing & Sanitation ( c )				242616.61
<b>Electrification Work - Canteen (d)</b>						
		<b>Electrical Specification As Per DTS.</b>				
<b>Part-01</b>		<b>Internal Wiring</b>				
		Point Wiring				
1	1-2-1(a)	Point wiring for Light / Bell with 2-1.5 sq.mm & earth wire of 1.5 sq.mm (Green) both are of ISI marked 1.1 KV grade FRLS PVC insulated multistrand copper wires, in following type of pipe to be erected Open/ concealed in/ on surface on wall/ceiling complete with 6A Modular type switch / bell push & accessories and earth continuity of following type, erected on PVC / Metallic box, single mounting base frame covered with textured/metallic front plate modules erected on / in wall / ceiling as per pipe erected, with necessary Lamp holder/ ceiling rose / H.D.Connector as directed. (a) with medium class Rigid PVC pipe and accessories - Cat III	34.00	424.20	Point	14422.80
2	1.1.4(a)	Secondary Light Point (Modular)	21.00	121.20	Point	2545.20
3	1-2-2(a)	Point wiring for FAN with 2-1.5 sq.mm & earth wire of 1.5 sq.mm (Green) both are of .ISI marked 1.1 KV Grade FRLS PVC insulated multistrand copper wires, in following type of pipe to be erected Open/ concealed in / flushed on wall/ceiling complete with 6A Modular type switch and hum free EME four or more step type electronic fan regulator with separately mounted and accessories with earth continuity of following type erected on PVC / Metallic box, single mounting base frame covered with textured/metallic front plate modules erected on / in wall / ceiling as per pipe erected. with necessary ceiling rose / H.D.Connector as directed. (a) with medium class Rigid PVC pipe and accessories Cat.III	10.00	606.00	Point	6060.00

ITEM NO	DTP NO	Description	Qty.	Rate	per	Amount
4	1-2-3(a)	Point wiring for Individual Plug with & earth wire of 1.5 sq.mm (Green) both are of ISI marked 1.1 KV grade FRLS PVC insulated multistrand copper wires, in following type of to be erected Open/ concealed in / on surface of wall / ceiling complete with Modular type switch & 5 pin Plug erected on PVC / Metallic box covered with appropriate front plate modules erected on / in wall / ceiling as per pi pe erected with following type of accessories. [I] For 6A Plug with 2-1.5 sq.mm Cu. Wire (a) with medium class Rigid PVC pipe and accessories Cat. III (a) with medium class Rigid PVC pipe and accessories	4.00	449.45	Point	1797.80
5	1-2-3 II (a)	[II] For 16A Plug with 2-2.5 sq.mm Cu. Wire (a) with medium class Rigid PVC pipe and accessories	5.00	676.70	Point	3383.50
6	1-2-3 III(a)	[III] For 16A Plug with 2-4 sq.mm Cu. Wire Cat III (a) with medium class Rigid PVC pipe and accessories	0.00	797.90	Point	0.00
7	1-2-4	Point wiring for Looped Plug with 6A Modular type switch & 5 pin socket erected on PVC / Metallic box, single mounting base frame covered with textured / metallic front plate modules erected on / in wall / ceiling with following type accessories Cat. III	6.00	242.40	Point	1454.40
		Providing following type of Modular Type Accessories mounted with pvc / metallic box, single mounting base frame covered with textured / metallic front plate , modules erected with necessary connection. As desired by Engineer In charge				
8	1-2-6 -3	(3) Two Pin/RJ-11 Telephone Socket [A] For One Gang Cat. III	1.00	161.60	Each	161.60
9	1-2-6 (7)	(7) Blank Plate Single Cat. III	16.00	25.25	Each	404.00
10	1-4-1.	Mains with 1.1 KV grade FRLS PVC insulated ISI marked stranded Copper conductor wire in following type of pipe to be erected concealed in /flushed on wall/ceiling, with 1.5 sq. mm copper conductor FRLS PVC insulated stranded wire of green color for earth continuity of following size (a) with medium class Rigid PVC pipe and accessories (c) 2 wire 1.5 sq. mm	120.00	60.60	Mtr.	7272.00
11	1-4-1	Mains with 1.1 KV grade FRLS PVC insulated ISI marked stranded Copper conductor wire in following type of pipe to be erected concealed in /flushed on wall/ceiling, with 1.5 sq. mm copper conductor FRLS PVC insulated stranded wire of green color for earth continuity of following size (a) with medium class Rigid PVC pipe and accessories (c) 2 wire 2.5 sq. mm	360.00	80.80	Mtr.	29088.00
12	1-4-2	Mains with 1.1 KV grade FRLS PVC insulated ISI marked stranded Copper conductor wire in following type of pipe to be erected in / on wall / ceiling with 2.5 sq. mm copper conductor FRLS PVC insulated stranded wire of green color for earth continuity of following size (a) with medium class Rigid PVC pipe and accessories (a) 2 wire 4 sq. mm	60.00	111.10	Mtr.	6666.00
13	1-4-2.	(h) 4 wire 6 sq. mm	0.00	262.60	Mtr.	0.00
14	1-4-8.	Supplying & erecting approved make LAN cable of following size in existing pipe as per direction [A] CAT - 5 (For Telephone Distribution)	40.00	30.30	Mtr.	1212.00
		Subtotal Part-01				74467.30
Part-02		Indoor Light Fixtures				

ITEM NO	DTP NO	Description	Qty.	Rate	per	Amount
	14-01-A.	Supplying and erecting LED indoor fittings with LEDs of wattage 0.2 Watt to 0.5 Watt assembled on single MCPCB, with housing used as a heat sink shall be made of thick sheet Steel conforming to IS: 513/CRCA polyester powder coated and high U.V. & corrosion resistance with diffuser and/or Polycarbonate optics with company mark/name 120 to 300 V, Power Factor more than 0.9, THD < 10 %, CCT 4000 K to 6500K, Uniformity ratio >0.7, Luminaire efficacy > 85 lumens/watt , LED driver efficiency > 85 % CREE / OSRAM / PHILIPS Lumileds / NICHIA / SEOUL/Bridgelux(U.S.A.) make LED used for luminaire. (Each fitting required LM-79 & LM-80 Certificates) (A) Tube Light with integral/ non-integral driver				
15		(d) 20-22 Watts, Surge - 4KV, IP-20, 4 feet Cat III	2.00	789.82	Each	1579.64
16		(e) 36 Watts, Surge-4 KV, IP-20, 4 feet Cat III	0.00	1137.26	Each	0.00
	14-01.	Supplying and erecting LED indoor fittings with LEDs of wattage 0.2 Watt to 0.5 Watt assembled on single MCPCB, with housing used as a heat sink shall be made of thick sheet Steel conforming to IS: 513/CRCA polyester powder coated and high U.V. & corrosion resistance with diffuser and/or Polycarbonate optics with company mark/name 120 to 300 V, Power Factor more than 0.9, THD < 10 %, CCT 4000 K to 6500K, Uniformity ratio >0.7, Luminaire efficacy > 85 lumens/watt , LED driver efficiency > 85 % CREE / OSRAM / PHILIPS Lumileds / NICHIA / SEOUL/Bridgelux(U.S.A.) make LED used for luminaire. (Each fitting required LM-79 & LM-80 Certificates)				
	14-01-B	(B) LED Lamps integral type, cool white with PC diffuser suitable for B22 LAMP holder				
17		(b) 5 to 8 watts	0.00	242.40	Each	0.00
	14-01-C	© Square/ Circular Surface/ Recessed Mounted Downlight with provision for spring loaded mounting clips complete.				
18		(b) 10-15 watts, Surge-4 KV Cat-III	0.00	896.88	Each	0.00
19		© 20-25 watts, Surge-4 KV Cat-III	10.00	1624.08	Each	16240.80
	14-01-G	(G) Spot Light , 5W, 425 Lumens, Surge-2KV				
20		(a) 5/7 Watts Cat-III	5.00	1737.20	Each	8686.00
21		(b) 11 Watts Cat-III	49.00	2949.20	Each	144510.80
	14-01-H	(H) Step Light having fibre reinforced plastic housing				
22		(a) 5 watts, Direct/Indirect luminaire Cat-III	12.00	1220.08	Each	14640.96
23	MR	Providing and erecting Surface / Suspended mounted waterproof Luminaire suitable for single and twin T8 TLED lamps. Indoor Industrial type LED fitting with master LED tube integrates LED light source with frosted cover design into traditional linear fluorescent form delivering 50% energy saving complete with Electronic Ballast, holder erected with lead wire and adapter if required. Equivalent to PHILIPS-TCW450 P1XTLED 19W P3397 & MAS LEDtube 1200mm 13W865 T8 I IN30	1.00	3020.00	Each	3020.00
24	MR	Supply, Erection, Testing & Commissioning of 10 to 15 watt LED Hanging luminary, with housing made of high pressure die cast aluminum & Poly carbonate front diffuser, IP66 protected & having impact resistance of IK09. Make: Havells, Bajaj, Crompton, Philips, GE Contractor Has to submit NABL approved Laboratory LM 79 and LM 80 Test certificate of model to be offered for confirmation of above specification.	20.00	1600.00	Each	32000.00
		Subtotal Part-02				220678.20
Part-03		LT Switchgear, Distribution Boards & LT Panel				

ITEM NO	DTP NO	Description	Qty.	Rate	per	Amount
		Providing and erecting Sheet Steel powder coated MCB distribution board - flush / surface mounted fitted with busbar, neutral link, earth bar and DIN rail, conforming to IS 13032 and BS 5486-1986 without MCB to house appropriate nos. of MCBs.(The DBs should be used of same company of MCB to be used)				
25	3-11-5	(H) Single phase 12 way SS Double door	1.00	1292.80	Each	1292.80
26	3-11-5	(N) Three phase 8 way SS Double door for horizontal single phase outgoing	1.00	2949.20	Each	2949.20
27	3-10-5.	Providing & erecting 415 V MCB Four Pole for Motor & Inductive Load (C Curve) having 10KA breaking capacity & confirms to IS :8828 in existing box having following capacity (A) 32 Amp Cat-III	0.00	616.10	Each	0.00
28		(c)63 Amp. Cat-III	1.00	757.50	Each	757.50
29	3-12-1.	Approved make ELCBs / RCCBs conforming to IS: 12640 and having sensitivity of 30 mA and Short Circuit withstand capacity of 10 KA and suitable for operation on single phase 240 V, having characteristic of quick action & tripping with all advance feature & do not incorporate any electronic component. for following Max. rating erected as directed. Cat III (ii) 40Amps. DP	3.00	2636.10	Each	7908.30
30	3-12-2.	Approved make ELCBs / RCCBs conforming to IS: 12640 and having sensitivity of 30 mA and Short Circuit withstand capacity of 6 KA and suitable for operation on 3 phase and neutral 415V. having characteristic of quick action & tripping with all advance feature & do not incorporate any electronic component for following Max. rating erected as directed. (iii) 63 Amps. FP Cat III	0.00	3585.50	Each	0.00
31	3-10-2.	Providing & erecting 240 V MCB double pole switch for motor & inductive load (C Curve) having 10 KA breaking capacity & confirms to IS : 8828 in existing box having following capacity (A) 6 to 32 Amp. Cat.III	3.00	308.05	Each	924.15
32	3-10-1	Miniature circuit breaker single pole 6A to 32A suitable to operate on 240 V A.C. system and having overload and short circuit tripping elements and breaking capacity 10 KA to be erected in existing M.S. box confirming to IS 8828/1996 with ISI mark. Cat.III	18	116.15	Each	2090.70
33	6-6-4.	Supplying and erecting bakelite sheet 12mm thick HYLAM make on existing angle iron frame.	13	131.30	Kg	1706.90
34	MR	Providing& fixing G.P. L-Slotted Angle (3" Gap, 16 Gauge ) and M.S L-Type Patti Bracket With PVC Coated (8mm) Nut-Bolts (with 2 wiser) and 3" Khila on wall at Levels of approved design including the cost of cutting, drilling holes & make good the wall etc coplete-For Meter Fitting Arrangement of Single/Three Phase Meterbox (with MCB) as per site requirment.	1.2	215.13	Rmtr	258.16
		Subtotal Part-03				17887.71
<b>Part-04</b>		Earthing System				
35	3-14-5.	Providing and erecting HOT deep Galvanised iron strip wire 8 to 16 SWG.	5	90.90	Kgs	454.50
36	3-14-12. (c)	Supplying and erecting earthen pit of minimum bore dia. 150 mm. size, approved make Safe Earthing Electrode, consisting of pipe-in-pipe technology as per IS 3043-1987, made of corrosion free g. i. pipes, having outer dia. of 50 mm., having 80-200 micron galvanizing, inner pipe dia. of 25 mm., having 200-250 micron galvanizing, connection terminal dia. of 12 mm., with constant ohmic value, surrounded by highly conductive compound with high charge dissipation, suitable for the following type of applications. -Length of Pipe : 3 Mtrs. -Back filling Compound :2 nos Bags of 25 Kg.	1	13584.50	Each	13584.50
		Subtotal Part-04				14039.00
<b>Part-05</b>		LT Cables & Cable Termination				

ITEM NO	DTP NO	Description	Qty.	Rate	per	Amount
	4-2-1.	Supplying & erecting XLPE(IS:7098)(I)-88 ISI unarmoured copper cable 1.1 KV grade to be erected as directed of following size.				
35		(L) 4 core 6 Sq. mm	0	353.50	Mtr.	0.00
36		(M) 4 core 10 Sq. mm	80	555.50	Mtr.	44440.00
37	4-5-1	Making trench in soft soil of suitable width of 90 cms deep for laying cable or locating the fault all over the run and backfilling the same and making the surface as normal ground.	60	40.40	Mtr.	2424.00
	4-6-1.	Providing and, fixing heavy duty flange type brass cable gland with rubber ring for PVC insulated armoured cable complete with out going tails, insulating tape etc for following size of cables.				
38		(c) 2 to 4 core 6/10 Sq. mm	2	40.40	Each	80.80
	4-7-2.	Solderless crimping type Copper lugs conforming to IS suitable for cable of following size evenly crimped with high pressure tool & connected to switchgear terminals with brass/cadmium plated nut bolts in an approved manner.				
39		(A) 1.5/2.5 to 6 Sq.mm	0	8.08	Each	0.00
40		(B) 10 Sq.mm	8	10.10	Each	80.80
	4-5-8.	Providing & laying approved make Double walled corrugated pipes (DWC) of polyethylene(conforming to IS 14930 II )with necessary connecting accessories of same material at required depth for laying of cable. below ground / road surface for enclosing cable and back filling the same to make ground as per original.				
41		(A)50 mm dia	60	146.45	Mtr.	8787.00
		Subtotal Part-05				55812.60
<b>Part-06</b>		<b>Fan &amp; Related Accessories</b>				
42	5-1-6.	Providing and erecting Approved make HIGH Speed Max. 50 Watt Ceiling fan with double ball bearing ISI mark with condenser A.C. 230V.50 c/s.1200 mm. sweep complete having 3 blades with aluminium blades with canopy and 30 cms. down rod erected on existing hook or clamp with 24/0.2 , 3 core flexible wire with earthing. [Latest 5 star Rating as per list declared by BEE]	10	2090.70	Each	20907.00
43	5-2-3.	Supplying & erecting fan hook box of 10 mm M.S. round bar bounded to the RCC bars up to 50mm length each side and pierced through a 16 Gauge M.S. box / Heavy Duty PVC box complete erected concealed in Ceiling with necessary finishing.	10	126.25	Each	1262.50
44	5-3-4.	Supplying & erecting single phase approved make industrial exhaust fan suitable for medium duty ring mounted low noise operation suitable for medium duty having following dia size and maximum speed in RPM [A] 305 mm dia 900 RPM- Cat II	3	2424.00	Each	7272.00
		Subtotal Part-06				29441.50
<b>Part-07</b>		<b>Water Cooler &amp; Purifier</b>				
45	8-8-1.	Providing & erecting water cooler having storage capacity 80 Ltr. & cooling capacity 40 Ltr.per hour @ an ambient temp of 450 C. The outlet temp. of the water should drop by 150C within a hour, The water cooler should be comprising of hermetically sealed compressor, fan motor, condensing unit, water tank surrounded by evaporating, coil, thermostats, relay etc.complete with necessary inlet & outlet connection. The body of water cooler will be made from Stainless Steel. 40 Litre Storage/80 Litre Cooling	1	36360.00	Each	36360.00
46	MR	STTC of Water Purifire Eureka Forbs Make AG 200 or Equivalent	1	10711.05	Each	10711.05
		Subtotal Part-07				47071.05
		<b>Total Amount of Electrification Canteen (d)</b>				<b>459397.36</b>
		<b>Total Amount of Canteen Civil Work (Part B)</b>				<b>4096975.99</b>

**(Part-C) Interior (Furniture & HVAC)Work**

ITEM NO	DTP NO	Description	Qty.	Rate	per	Amount
<b>Part 1 - Furniture</b>						
<b>(a) CEILING</b>						
1	122	Supply & fixing of 16mm thick Armstrong-All RH 99 mineral fiber& Metal ceiling with 24 mm grid (local)G I frame girid consist of 600mm X 600mm tecno grid pre coated main runner 38x24x3600mm, cross T 30x24x1200mm, cross runner 24x24x600mm, wall angle 24x24mm required lenght suspension wire of 2.50mm G I & necessary hardware etc. complete aprooved by engineer in charge. For Zone-1 - Minimal risk :- waiting rooms, Technical services, Administrative office, corridors & stairways. use armstrong perforation Sheet.	795.00	SQ.MT	862.41	685619.13
<b>(b) WALL PANELLING</b>						
2	123	Prov. & Fixing 600 mm x 600mm x 12mm Perforated Gypsum on wall with the property of class "0" fire propagation, random perforation of minimum perforation of 10mm and not less then 300 nos and total nos of perforation not less then 750 nos directly fitted on G I ceiling section 80 x 26 x 0.5mm with perimeter channel of 20 x 27 x 30x 0.5mm on every 600mm vertical and horizontal, wood wool board alternate panel shall be offsetted 25mm with 24 density fiber glass wool in non woven cloth bag of 35 gam preferably black in colour to achieve 0.74 NRC value, finished over to all look with jointing finishing method with glass fiber paper tapes companys branded jointing compound for crek free, smooth look and level all four side, charge perfecity brand GYPONITE / GYPTECH / INDIA GYPSUM mpa.4, hook clip:adjustable hook clip of 0.8mm th. 80 g/sq. m galvanized apring steel for 2.60 mm wire with a minimum pull of 110 kg. the adjustable clip consists of 3.5mm aquiline wire toused with the main runner. 5, T - girid : super finr 15mm exposed suspantion, as per design provided by the consultant market rate . use armstrong perforation Sheet.	230.00	SQ.MT	995.00	228850.00
<b>(c) FURNITURE WORK AND REVOLVING CHAIR &amp; SOFA SET</b>						
3	124	Providing & fixing & making 4'0" x 4'2" x 2'3" (2 - seating) Work Space Table using pre-laminated board Drawer's make action tesa or equivalent brand ( 9mm, 11mm, 12mm, 17mm, 18mm & 25mm) . All the outer surface cover by I.S.I. brand Sunmica of Formica , silicone ,bloom green or equivalent & inner 1.5mm thick Laminate Sheet silicone or bloom or equivalent Brand.using drawer channel of Hetich brand & handle s.s. matt & drawer lock , including S.S Screws , necessary hardware etc. and Inbuilt fixing With MS Angel complete including necessary polish, hardware and labour etc. As per attached drawing & instructed by in charge Consultant.	80.00	NOS.	18420.00	1473600.00
4	125	Providing & fixing & making 8'0" x 2'6" Size Reception Table using pre-laminated board action tesa or equivalent brand ( 9mm, 11mm, 12mm, 17mm, 18mm & 25mm) . All the outer surface cover by I.S.I. brand Sunmica of Formica , silicone ,bloom green or equivalent & inner 1.5mm thick Laminate Sheet silicone or bloom or equivalent Brand.using drawer channel of Hetich brand & handle s.s. matt & drawer lock , including S.S Screws , necessary hardware etc. and Inbuilt fixing With MS Angel complete including necessary polish, hardware and labour etc. As per attached drawing & instructed by in charge Consultant.	2.00	NOS.	22510.00	45020.00



<b>ITEM NO</b>	<b>DTP NO</b>	<b>Description</b>	<b>Qty.</b>	<b>Rate</b>	<b>per</b>	<b>Amount</b>
5	126	Providing & fixing & making 8'0" x 3'0" Size Executive Office Table top with pre-laminated particle board action tesa or equivalent brand ( 9mm, 11mm, 12mm, 17mm, 18mm & 25mm) of ISI marked top in action tesa brand with 2mm PVC edge beading with hot melt glue in 180° C & other edge banding 0.45mm thick. Two side Square top for superior quality table with thickness of 18mm & in other side with good quality telescopic Channel & S.S. finish handle for Drawers and doors with foot rest, 10mm tempered glass on top in table . All the outer surface cover by I.S.I. brand Sunmica of Formica , silicone ,bloom green or equivalent & inner 1.5mm thick Laminate Sheet silicone or bloom or equivalent Brand.using drawer channel of Hetich brand & handle s.s. matt & drawer lock , including S.S Screws , necessary hardware etc. and Inbuilt fixing With MS Angel complete including necessary polish, hardware and labour etc. As per attached drawing & instructed by in charge Consultant.	2.00	NOS.	42980.00	85960.00
6	127	Providing & fixing & making Class Room Table 8'0" x 2'0" using pre-laminated particle board action tesa or equivalent brand ( 9mm, 11mm, 12mm, 17mm, 18mm & 25mm Top with Pre-laminated particle board of ISI marked top in in action tesa brand with 2mm PVC edge beading with hot melt glue in 180°C & other edge banding 0.45 mm thick, All side square top for superior quality table with thickness of 25 mm. . All the outer surface cover by I.S.I. brand Sunmica of Formica , silicone ,bloom green or equivalent & inner 1.5mm thick Laminate Sheet silicone or bloom or equivalent Brand.using drawer channel of Hetich brand & handle s.s. matt & drawer lock , including S.S Screws , necessary hardware etc. complete including necessary polish, hardware and labour etc. As per attached drawing & instructed by in charge Consultant.	2.00	NOS.	20980.00	41960.00
7	128	Providing & fixing & making Office Room Table 4'0" x 2'6" using pre-laminated particle board action tesa or equivalent brand ( 9mm, 11mm, 12mm, 17mm, 18mm & 25mmTop with Pre-laminated particle board of ISI marked top in in action tesa brand with 2mm PVC edge beading with hot melt glue in 180°C & other edge banding 0.45 mm thick, All side square top for superior quality table with thickness of 25 mm.. All the outer surface cover by I.S.I. brand Sunmica of Formica , silicone ,bloom green or equivalent & inner 1.5mm thick Laminate Sheet silicone or bloom or equivalent Brand.using drawer channel of Hetich brand & handle s.s. matt & drawer lock , including S.S Screws , necessary hardware etc. complete including necessary polish, hardware and labour etc. As per attached drawing & instructed by in charge Consultant.	20.00	NOS.	15350.00	307000.00
8	129	Providing & fixing & making Meeting Room Table 6'5" x 4'3" using pre-laminated particle board action tesa or equivalent brand ( 9mm, 11mm, 12mm, 17mm, 18mm & 25mm Conference Table manufactured from high quality plb top in action tesa brand for surface & legs (25mm). . All the outer surface cover by I.S.I. brand Sunmica of Formica , silicone ,bloom green or equivalent & inner 1.5mm thick Laminate Sheet silicone or bloom or equivalent Brand.using drawer channel of Hetich brand & handle s.s. matt & drawer lock , including S.S Screws , necessary hardware etc. complete including necessary polish, hardware and labour etc. As per attached drawing & instructed by in charge Consultant.	3.00	NOS.	32750.00	98250.00

ITEM NO	DTP NO	Description	Qty.	Rate	per	Amount
9	130	Providing & fixing & making Canteen/Meeting Room Table 4'0" x 2'6" (Top with Pre-laminated particle board of ISI marked top in in action tesa brand with 2mm PVC edge beading with hot melt glue in 180°C & other edge banding 0.45 mm thick, All side square top for superior quality table with thickness of 25 mm.. All the outer surface cover by I.S.I. brand Sunmica of Formica , silicone ,bloom green or equivalent & inner 1.5mm thick Laminate Sheet silicone or bloom or equivalent Brand.using drawer channel of Hetich brand & handle s.s. matt & drawer lock , including S.S Screws , necessary hardware etc. complete including necessary polish, hardware and labour etc. As per attached drawing & instructed by in charge Consultant.	15.00	NOS.	15350.00	230250.00
10	131	Providing & fixing & making STORAGE 6'0" x 3'0" x 1'6" using pre-laminated particle board action tesa or equivalent brand ( 9mm, 11mm, 12mm, 17mm, 18mm & 25mm) . All the outer surface cover by I.S.I. brand Sunmica of Formica , silicone ,bloom green or equivalent & inner 1.5mm thick Laminate Sheet silicone or bloom or equivalent Brand.using drawer channel of Hetich brand & handle s.s. matt & drawer lock , including S.S Screws , necessary hardware etc. complete including necessary polish, hardware and labour etc. As per attached drawing & instructed by in charge Consultant. near Locker Officer	35.00	NOS.	13820.00	483700.00
11	132	Providing & fixing 12mm thick tougffan glass door with enox fittings & also with floor spring of enox.note flooring cutting covered inthis item so no extra claim for vitrified / kotah flooring .	78.00	SM	7610.00	593580.00
12	133	Providing & fixing 12mm thick toughend glass partition with enox D-brecket fittings in this item so no extra claim for vitrified / kotah flooring .	147.00	SM	3600.33	529248.51
13	SELF EXPL.	Providing of Executive Revolving chair as per directed by Architect/Engineer - in - charge chair	3.00	NOS	6660.00	19980.00
14	SELF EXPL.	Providing of Staff & Waiting Area Revolving chair as per directed by Architect/Engineer - in - charge	40.00	NOS	4100.00	164000.00
15	SELF EXPL.	Providing of Other Revolving chair as per directed by Architect/Engineer - in - charge ALL FLOOR	235.00	NOS.	3070.00	721450.00
16	SELF EXPL.	Providing of Fix Class Rooms chair as per directed by Architect/Engineer - in - charge ALL FLOOR	59.00	NOS.	3590.00	211810.00
17	SELF EXPL.	Providing of Fix Canteen or Meeting Room Teak Wood chair as per directed by Architect/Engineer - in - charge ALL FLOOR	48.00	NOS.	4100.00	196800.00
18	SELF EXPL.	Providing of puffy with cushion chair as per directed by Architect/Engineer - in - charge ALL FLOOR	24.00	NOS.	1850.00	44400.00
19	134	Providing & fixing & making Canteen/Meeting Room Table 4'0" x 1'6" (Top with Pre-laminated particle board of ISI marked top in in action tesa brand with 2mm PVC edge beading with hot melt glue in 180°C & other edge banding 0.45 mm thick, All side square top for superior quality table with thickness of 25 mm.. All the outer surface cover by I.S.I. brand Sunmica of Formica , silicone ,bloom green or equivalent & inner 1.5mm thick Laminate Sheet silicone or bloom or equivalent Brand.using drawer channel of Hetich brand & handle s.s. matt & drawer lock , including S.S Screws , necessary hardware etc. complete including necessary polish, hardware and labour etc. As per attached drawing & instructed by in charge Consultant. ALL FLOOR	8.00	NOS.	5940.00	47520.00

ITEM NO	DTP NO	Description	Qty.	Rate	per	Amount
20	SELF EXPL.	Providing of Fix 3 seats perforated (chromium plated) cluster chair on beam with handle.For Waiting Area as per directed by Architect/Engineer - in - charge				
		ALL FLOOR	6.00	NOS.	6350.00	38100.00
21	135	Providing & fixing & making of Auditorium Sitting using Ply (Derby,Brand Saras, Wood Stock or century sainik brand Drawer's make by 20,19,18,12,10,8 mm ply) . fixing of Australian Or Canadian pine wood for Seating & including S.S Screws , necessary hardware etc. complete including necessary with Polishing with Melamine Polise , hardware and labour etc. As per attached drawing & instructed by in charge Consultant.				
		ALL FLOOR	122.00	SM	5556.00	677832.00
22	136	Providing &Laying Wooden flooring Size 1215 x 163 mm Thickness 12 mm on polyethylene foam including skirting and All necessary fittings with flush pointing & cleaning the surface etc. comp. & Directed by Engg. In charge & Architect etc. comp. Specifications: AC 5, Embossed finish, Real V- Size: 1215 x 163 x 12 mm or as directed by Architect/Engineer - in- charge.				
		ALL FLOOR	190.00	SM	3280.00	623200.00
		<b>Total Furniture Work</b>				<b>7548129.64</b>
<b>(PART-2) HVAC Central AC System</b>						
<b>HVAC Specification As Per ITEM</b>						
1		AIR-COOLED TYPE DUCTABLE UNITS				
		SPLIT UNITS :				
		S/I/T/C of Air-cooled type complete with the following components-				
		The average distance between indoor and outdoor units shall be 20 RMT as specified				
		Indoor evaporating unit comprising of cooling coils, insulated sand-witched drain tray ,20 Micron HDPE washable filters, blower, electrical junction box etc.				
		Outdoor condensing unit comprising of hermetic scroll compressors in multipel circuits, condenser coils, propeller / axial fans pressure switches/ cutouts etc.				
		Necessary Refrigerant Gas and oil charge. Inter-connected refrigerating piping of copper duly insulated with EXPANDED POLYETHYLENE SECTIONS laying on perforated cable tray				
		Complete electrical power wiring of Al. & control wiring of copper required from indoor and outdoor units. Earthing of the complete system with 8 G G.I. wire.				
		Electrical Panel will be complete with necessary starters, fuses, switches, timers, over- load relays, contactors, push button, and indicating lamps, single phasing PREVENTOR etc and ALSO WITH REMOTE CONTROL WITH CORDING.				
		The panel should have 1 No. potential free contactor to connect with central fire detection system. The panel should also have voltage scanner to ensure stabilized power input to the machine.				
		All outdoors units shall be mounted on MS angle base frame structure duly black painted with synthetic epoxy paint.				
		The frame structure shall be mounted on MS plate & serrated rubber pads.				
		Complete clamping and saddling of cabling work and refrigerant piping, covered with P V C conduiting.				
a		8.50 TR (Compressors 4.25TR X 2Nos) (Equivalent make of Hitachi, Carrier, Daikin, Mitsubishi)	2.00	No.	218100.00	436200.00
b		7.50 TR (Compressors 2.5TR X 3Nos)(Equivalent make of Hitachi, Carrier, Daikin, Mitsubishi)	1.00	No.	205600.00	205600.00

ITEM NO	DTP NO	Description	Qty.	Rate	per	Amount
2		Extra Hard & Soft Refrigerant Piping, thermal insulations & Cabling beyond specified limits between indoor & outdoor unit for following capacities				
a		8.50 TR Ductable Unit	80.00	RFT	410.00	32800.00
b		7.50 TR Ductable Unit	80.00	RFT	275.00	22000.00
3		AIR-COOLED CEILING SUSPENDED CONCEALED TYPE				
		SPLIT UNITS :				
		S/I/T/C of Air-cooled type complete with the following components-				
		The average distance between indoor and outdoor units shall be 20 RMT as specified				
		Indoor evaporating unit comprising of cooling coils, insulated sand-witched drain tray ,20 Micron HDPE washable filters, blower, electrical junction box,necessary canvass connections to connect with indoors etc.				
		Outdoor condensing unit comprising of hermetic scroll compressors in multipel circuits, condenser coils, propeller / axial fans pressure switches/ cutouts etc.				
		Necessary Refrigerant Gas and oil charge. Inter-connected refrigerating piping of copper duly insulated with EXPANDED POLYETHYLENE SECTIONS laying on perforated cable tray				
		Complete electrical power wiring of Al. & control wiring of copper required from indoor and outdoor units. Earthing of the complete system with 8 G G.I. wire.				
		Electrical Panel will be complete with necessary starters, fuses, switches, timers, over- load relays, contactors, push button, and indicating lamps, single phasing PREVENTOR etc and ALSO WITH REMOTE CONTROL WITH CORDING.				
		The panel should have 1 No. potential free contactor to connect with central fire detection system. The panel should also have voltage scanner to ensure stabilized power input to the machine.				
		All outdoors units shall be mounted on MS angle base frame structure duly black painted with synthetic epoxy paint.				
		The frame structure shall be mounted on MS plate & serrated rubber pads.				
		Complete clamping and saddling of cabling work and refrigerant piping, covered with P V C conduiting.				
a		7.50 TR (Compressors 2.5TR X 3Nos)(Equivalent make of Hitachi, Carrier, Daikin, Mitsubishi)	4.00	No.	206000.00	824000.00
4		AIR-COOLED HI-WALL SPLIT UNITS :				
		S/I/T/C of Air-cooled type complete with the following components-				
		The average distance between indoor and outdoor units shall be 20 RMT as specified				
		Indoor evaporating unit comprising of cooling coils, insulated sand-witched drain tray ,20 Micron HDPE washable filters, blower, electrical junction box etc.				
		Outdoor condensing unit comprising of hermetic scroll compressors, condenser coils, propeller / axial fans pressure switches/ cutouts etc.				
		Necessary Refrigerant Gas and oil charge. Inter-connected refrigerating piping of copper duly insulated with EXPANDED POLYETHYLENE SECTIONS				

ITEM NO	DTP NO	Description	Qty.	Rate	per	Amount
		Complete electrical power wiring of Al. & control wiring of copper required from indoor and outdoor units. Earthing of the complete system with 8 G G.I. wire.				
		Electrical Panel will be complete with necessary starters, fuses, switches, timers, over- load relays, contactors, push button, and indicating lamps, single phasing PREVENTOR etc and ALSO WITH REMOTE CONTROL WITH CORDING.				
		The panel should have 1 No. potential free contactor to connect with central fire detection system. The panel should also have voltage scanner to ensure stabilized power input to the machine.				
		All outdoors units shall be mounted on MS angle base frame structure duly black painted with synthetic epoxy paint.				
		The frame structure shall be mounted on MS plate & serrated rubber pads.				
		Complete clamping and saddling of cabling work and refrigerant piping, covered with P V C conduiting.				
a		2.0 TR Hi-wall Unit minemum 5 STAR RATING-Non-Inverter (Equivalent make of Hitachi, Carrier, Daikin, Mitsubishi)	12.00	Nos	64100.00	769200.00
b		1.50 TR Hi-wall Unit minemum 5 STAR RATING-Non-Inverter (Equivalent make of Hitachi, Carrier, Daikin, Mitsubishi)	6.00	Nos	53100.00	318600.00
c		1.00 TR Hi-wall Unit minimum 5 STAR RATING-Non-Inverter (Equivalent make of Hitachi, Carrier, Daikin, Mitsubishi)	1.00	Nos	47300.00	47300.00
5		Insulated HARD PVC Drain piping for following sizes				
a		25 mm	250.00	RFT	35.00	8750.00
b		32 mm	150.00	RFT	45.00	6750.00
c		40 mm	0.00	RFT	65.00	0.00
d		50 mm	0.00	RFT	95.00	0.00
6		Sheet metal Works:				
I		Rectangular Duct FOR S./R.AIR As per IS-655- Ducting complete with hangers, anchor fasteners, MS structure for supports of ducting, guiding vanes, MS angle frame work only.				
a		24 gauge	1000.00	Sq. ft.	78.00	78000.00
b		22 gauge	225.00	Sq. ft.	80.00	18000.00
c		20 gauge	0.00	Sq. ft.	92.00	0.00
II		Powder Coated Extruded Aluminium Linear /(Square Grilles 600 mm x 600 mm) Of Required Airflow Angles With Out VCD.	150.00	Sq. ft.	650.00	97500.00
III		GI opposed blade duct dampers	10.00	Sq. ft.	1000.00	10000.00
IV		GI opposed blade Gravity dampers	0.00	Sq. ft.	1200.00	0.00
V		Al. opposed blade grille dampers	25.00	Sq. ft.	600.00	15000.00
VI		Aluminium Powder Coated Supply Air Square Diffuser With V.C.D (600 mm x 600 mm)	0.00	Nos.	0.00	0.00
VII		Aluminium Powder Coated Return Air Square Diffuser Without V.C.D (600 mm x 600 mm)	0.00	Nos.	0.00	0.00
VIII		Aldes type Fresh air Controller for Cassatte Unit for following Capacities:				
a		70 CFM	0.00	Nos.	0.00	0.00
b		60 CFM	0.00	Nos.	0.00	0.00
c		50 CFM	0.00	Nos.	0.00	0.00
7		INSULATION WORK				

ITEM NO	DTP NO	Description	Qty.	Rate	per	Amount
I		Acoustic Insulation Of Ducts with Fiberglass of density 48 Kg/ Cu. M. & covered with RP Tissue & 28 G Perforated Aluminium sheet from inside of the duct. 12.5 MM	225.00	Sq. ft.	55.00	12375.00
II		Thermal Insulation Of Ducts with Nitrile Rubber/EPDM				
a		9 MM THK	1000.00	Sq. ft.	65.00	65000.00
III		Under deck Insulation With 50 MM Thick "TF" Quality Expanded Polystyrene with GI cross wire and 36G Aluminium Foil	0.00	Sq. ft.	70.00	0.00
IV		False Ceiling Insulation With 50 mm thick Fiber Glass of 16 Kg/CuM density packed in Polythene Bags	0.00	Sq. ft.	45.00	0.00
V		Acoustic Insulation Of AHU Room with 25mm thick Fiberglass of density 48 Kg/ Cu. M. & covered with RP Tissue & 28 G Perforated Aluminium sheet.	0.00	Sq. ft.	75.00	0.00
		<b>SUB-TOTAL 1</b>				2967075.00
		<b>Add Labour Cess 1%</b>				29670.75
		<b>Total amount of HVAC Central AC System</b>				<b>2996745.75</b>
		<b>TOTAL INTERIOR WORK</b>				<b>10544875.39</b>
<b>Electrification Work- Incubation Center (Part-D)</b>						
		<b>Electrical Specification As Per DTS and Item Specification.</b>				
ItemSr.No.	SOR Sr. No	Description of Work/ Item	Qty	Total Rate	Unit	TotalAmount
<b>Part-01</b>		Internal Wiring				
1	1-2-1(a)	Point Wiring Point wiring for Light / Bell with 2-1.5 sq.mm & earth wire of 1.5 sq.mm (Green) both are of ISI marked 1.1 KV grade FRLS PVC insulated multistrand copper wires, in following type of pipe to be erected Open/ concealed in/ on surface on wall/ceiling complete with 6A Modular type switch / bell push & accessories and earth continuity of following type, erected on PVC / Metallic box, single mounting base frame covered with textured/metallic front plate modules erected on / in wall / ceiling as per pipe erected, with necessary Lamp holder/ ceiling rose / H.D.Connector as directed.	262	424.20	Point	<b>111140.40</b>
2	1.1.4(a)	Secondary Light Point (Modular)	94	121.20	Point	<b>11392.80</b>
3	1-2-2(a)	Point wiring for FAN with 2-1.5 sq.mm & earth wire of 1.5 sq.mm (Green) both are of .ISI marked 1.1 KV Grade FRLS PVC insulated multistrand copper wires, in following type of pipe to be erected Open/ concealed in / flushed on wall/ceiling complete with 6A Modular type switch and hum free EME four or more step type electronic fan regulator with separately mounted and accessories with earth continuity of following type erected on PVC / Metallic box, single mounting base frame covered with textured/metallic front plate modules erected on / in wall / ceiling as per pipe erected. with necessary ceiling rose / H.D.Connector as directed. (a) with medium class Rigid PVC pipe and accessories Cat.III	70	606.00	Point	<b>42420.00</b>



ITEM NO	DTP NO	Description	Qty.	Rate	per	Amount
4	1-2-3(a)	Point wiring for Individual Plug with & earth wire of 1.5 sq.mm (Green) both are of ISI marked 1.1 KV grade FRLS PVC insulated multistrand copper wires, in following type of to be erected Open/ concealed in / on surface of wall / ceiling complete with Modular type switch & 5 pin Plug erected on PVC / Metallic box covered with appropriate front plate modules erected on / in wall / ceiling as per pi pe erected with following type of accessories. [I] For 6A Plug with 2-1.5 sq.mm Cu. Wire (a) with medium class Rigid PVC pipe and accessories Cat. III (a) with medium class Rigid PVC pipe and accessories	30	449.45	Point	13483.50
5	1-2-3 II (a)	[II] For 16A Plug with 2-2.5 sq.mm Cu. Wire (a) with medium class Rigid PVC pipe and accessories	28	676.70	Point	18947.60
6	1-2-3 III(a)	[III] For 16A Plug with 2-4 sq.mm Cu. Wire Cat III (a) with medium class Rigid PVC pipe and accessories	15	797.90	Point	11968.50
7	1-2-4	Point wiring for Looped Plug with 6A Modular type switch & 5 pin socket erected on PVC / Metallic box, single mounting base frame covered with textured / metallic front plate modules erected on / in wall / ceiling with following type accessories Cat. III	58	242.40	Point	14059.20
8	1-2-6-3	(3) Two Pin/RJ-11 Telephone Socket [A] For One Gang Cat. III	112	161.60	Each	18099.20
9	1-2-6 (7)	(7) Blank Plate Single Cat. III	160	25.25	Each	4040.00
10	1-2-6 (8)	(8) Modem Jack for Computer Open RJ-45 - Cat III	196	161.60	Each	31673.60
11	1-2-6 (22)	(22) 16/20/25 Amp. Modular Starter for Motor / A.C. Unit Complete - Cat III	2	505.00	Each	1010.00
12	1-3-6 (a)	(A) Supplying and laying UPVC cable trucking system comprising unplasticised polyvinyl, chloride rigid material with ignition free & flame proof confirming BS. With All necessary accessories (Like elbow, tee, bank etc..) and measuring of following sizes. (2) 100 mm x 50 mm trunking	180	434.30	Mtr.	78174.00
13	1-4-1.	Mains with 1.1 KV grade FRLS PVC insulated ISI marked stranded Copper conductor wire in following type of pipe to be erected concealed in /flushed on wall/ceiling, with 1.5 sq. mm copper conductor FRLS PVC insulated stranded wire of green color for earth continuity of following size (a) with medium class Rigid PVC pipe and accessories (c) 2 wire 1.5 sq. mm	1267	60.60	Mtr.	76780.20
14	1-4-1	Mains with 1.1 KV grade FRLS PVC insulated ISI marked stranded Copper conductor wire in following type of pipe to be erected concealed in /flushed on wall/ceiling, with 1.5 sq. mm copper conductor FRLS PVC insulated stranded wire of green color for earth continuity of following size (a) with medium class Rigid PVC pipe and accessories (c) 2 wire 2.5 sq. mm	1922	80.80	Mtr.	155297.60
15	1-4-2	Mains with 1.1 KV grade FRLS PVC insulated ISI marked stranded Copper conductor wire in following type of pipe to be erected in / on wall / ceiling with 2.5 sq. mm copper conductor FRLS PVC insulated stranded wire of green color for earth continuity of following size (a) with medium class Rigid PVC pipe and accessories (a) 2 wire 4 sq. mm	625	111.10	Mtr.	69437.50
16	1-4-2.	(h) 4 wire 6 sq. mm	255	262.60	Mtr.	66963.00
17	1-4-8.	Supplying & erecting approved make LAN cable of following size in existing pipe as per direction [A] CAT - 5 (For Telephone Distribution)	0	30.30	Mtr.	0.00

ITEM NO	DTP NO	Description	Qty.	Rate	per	Amount
18	1-4-8.	Supplying & erecting approved make LAN cable of following size in existing pipe as per direction [D] CAT - 6 e (For Computer Network/LAN)	0	70.70	Mtr.	0.00
19	1-6-2.	Providing & erecting Switch board for Computer or electric apparatus consisting of following items in single board erected on PVC / Metal board with 3 mm thick PC (Polycarbonate) / Acrylic sheet erected as directed 1 no. 6A/16A universal plug-switch combined. 4 nos. 6A Switch 4 nos. 6A 5 pin Plug [B] For Modular Type Accessories Cat-III	131	1151.40	Each	150833.40
		Subtotal Part-01				875720.50
<b>Part-02</b>		Indoor Light Fixtures				
	14-01-A.	Supplying and erecting LED indoor fittings with LEDs of wattage 0.2 Watt to 0.5 Watt assembled on single MCPCB, with housing used as a heat sink shall be made of thick sheet Steel conforming to IS: 513/CRCA polyester powder coated and high U.V. & corrosion resistance with diffuser and/or Polycarbonate optics with company mark/name 120 to 300 V, Power Factor more than 0.9, THD < 10 %, CCT 4000 K to 6500K, Uniformity ratio >0.7, Luminaire efficacy > 85 lumens/watt , LED driver efficiency > 85 % CREE / OSRAM / PHILIPS Lumileds / NICHIA / SEOUL/Bridgelux(U.S.A.) make LED used for luminaire. (Each fitting required LM-79 & LM-80 Certificates) (A) Tube Light with integral/ non-integral driver				
20		(d) 20-22 Watts, Surge - 4KV, IP-20, 4 feet Cat III	69	789.82	Each	54497.58
21		(e) 36 Watts, Surge-4 KV, IP-20, 4 feet Cat III	0	1137.26	Each	0.00
	14-01.	Supplying and erecting LED indoor fittings with LEDs of wattage 0.2 Watt to 0.5 Watt assembled on single MCPCB, with housing used as a heat sink shall be made of thick sheet Steel conforming to IS: 513/CRCA polyester powder coated and high U.V. & corrosion resistance with diffuser and/or Polycarbonate optics with company mark/name 120 to 300 V, Power Factor more than 0.9, THD < 10 %, CCT 4000 K to 6500K, Uniformity ratio >0.7, Luminaire efficacy > 85 lumens/watt , LED driver efficiency > 85 % CREE / OSRAM / PHILIPS Lumileds / NICHIA / SEOUL/Bridgelux(U.S.A.) make LED used for luminaire. (Each fitting required LM-79 & LM-80 Certificates)				
	14-01-B	(B) LED Lamps integral type, cool white with PC diffuser suitable for B22 LAMP holder				
22		(b) 5 to 8 watts	19	242.40	Each	4605.60
	14-01-C	© Square/ Circular Surface/Recessed Mounted Downlight with provision for spring loaded mounting clips complete.				
23		(b) 10-15 watts, Surge-4 KV Cat-III	4	896.88	Each	3587.52
24		© 20-25 watts, Surge-4 KV Cat-III	97	1624.08	Each	157535.76
	14-01-D	(D) LED Panel Light with provision for Plane front frame with translucent cover fixed to housing complete.				
25		(f) upto 36 watts, 600 x 600 mm, Surge- 4KV Cat-III	94	3886.48	Each	365329.12
	14-01-G	(G) Spot Light , 5W, 425 Lumens, Surge-2KV				
26		(a) 5/7 Watts Cat-III	5	1737.20	Each	8686.00
27		(b) 11 Watts Cat-III	2	2949.20	Each	5898.40
	14-01-H	(H) Step Light having fibre reinforced plastic housing				
28		(a) 5 watts, Direct/Indirect luminaire Cat-III	19	1220.08	Each	23181.52

ITEM NO	DTP NO	Description	Qty.	Rate	per	Amount
29	MR	Providing and erecting Surface / Suspended mounted waterproof Luminaire suitable for single and twin T8 TLED lamps. Indoor Industrial type LED fitting with master LED tube integrates LED light source with frosted cover design into traditional linear fluorescent form delivering 50% energy saving complete with Electronic Ballast, holder erected with lead wire and adapter if required. Equivalent to PHILIPS-TCW450 P1XTLED 19W P3397 & MAS LEDtube 1200mm 13W865 T8 I IN30	14	3020.00	Each	42280.00
30	MR	Supply, Erection, Testing & Commissioning of 10 watt LED Bulk Head luminary, having min. 600 lumen out put, with housing made of high pressure die cast aluminum & Poly carbonate front diffuser, IP66 protected & having impact resistance of IK09. Make: Havells, Bajaj, Crompton, Philips, GE Contractor Has to submit NABL approved Laboratory LM 79 and LM 80 Test certificate of model to be offered for confirmation of above specification.	2	1600.00	Each	3200.00
		Subtotal Part-02				668801.50
<b>Part-03</b>		LT Switchgear, Distribution Boards & LT Panel				
31	RA	Supply, Erection, Testing & Commissioning of Main LT PCC Panel	1	101815.58	Each	101815.58
32	3-11-5	Providing and erecting Sheet Steel powder coated MCB distribution board - flush / surface mounted fitted with busbar, neutral link, earth bar and DIN rail, confirming to IS 13032 and BS 5486-1986 without MCB to house appropriate nos. of MCBs.(The DBs should be used of same company of MCB to be used) (H) Single phase 12 way SS Double door	2	1292.80	Each	2585.60
33	3-11-5	(N) Three phase 8 way SS Double door for horizontal single phase outgoing	6	2949.20	Each	17695.20
34	3-11-5.	(L) Three phase 6 way SS Double door for single phase outgoing horizontal box	2	2514.90	Each	5029.80
35	3-10-5.	Providing & erecting 415 V MCB Four Pole for Motor & Inductive Load (C Curve) having 10KA breaking capacity & confirms to IS :8828 in existing box having following capacity (A) 32 Amp Cat-III	2	616.10	Each	1232.20
36		(c)63 Amp. Cat-III	6	757.50	Each	4545.00
37	3-12-1.	Approved make ELCBs / RCCBs conforming to IS: 12640 and having sensitivity of 30 mA and Short Circuit withstand capacity of 10 KA and suitable for operation on single phase 240 V. having characteristic of quick action & tripping with all advance feature & do not incorporate any electronic component. for following Max. rating erected as directed. Cat III (ii) 40Amps. DP	18	2636.10	Each	47449.80
38	3-12-2.	Approved make ELCBs / RCCBs conforming to IS: 12640 and having sensitivity of 30 mA and Short Circuit withstand capacity of 6 KA and suitable for operation on 3 phase and neutral 415V. having characteristic of quick action & tripping with all advance feature & do not incorporate any electronic component for following Max. rating erected as directed. (iii) 63 Amps. FP Cat III	2	3585.50	Each	7171.00
39	3-10-2.	Providing & erecting 240 V MCB double pole switch for motor & inductive load (C Curve) having 10 KA breaking capacity & confirms to IS : 8828 in existing box having following capacity (A) 6 to 32 Amp. Cat.III	24	308.05	Each	7393.20
40	3-10-1	Miniature circuit breaker single pole 6A to 32A suitable to operate on 240 V A.C. system and having overload and short circuit tripping elements and breaking capacity 10 KA to be erected in existing M.S. box confirming to IS 8828/1996 with ISI mark. Cat.III	164	116.15	Each	19048.60
41	6-6-4.	Supplying and erecting bakelite sheet 12mm thick HYLAM make on existing angle iron frame.	13	131.30	Kg	1706.90

ITEM NO	DTP NO	Description	Qty.	Rate	per	Amount
42	MR	Providing & fixing G.P. L-Slotted Angle (3" Gap, 16 Gauge ) and M.S L-Type Patti Bracket With PVC Coated (8mm) Nut-Bolts (with 2 wiser) and 3" Khila on wall at Levels of approved design including the cost of cutting, drilling holes & make good the wall etc coplete-For Meter Fitting Arrangement of Single/Three Phase Meterbox (with MCB) as per site requirment.	1.2	215.13	Rmtr	258.16
		Subtotal Part-03				215931.03
<b>Part-04</b>		Earthing System				
43	3-14-5.	Providing and erecting HOT deep Galvanised iron strip wire 8 to 16 SWG.	25	90.90	Kgs	2272.50
44	3-14-12. (c)	Supplying and erecting earthen pit of minimum bore dia. 150 mm. size, approved make Safe Earthing Electrode, consisting of pipe-in-pipe trechnology as per IS 3043-1987, made of corrosion free g. i. pipes, having outer dia. of 50 mm., having 80-200 micron galvanizing, inner pipe dia. of 25 mm., having 200-250 micron galvanizing, connection terminal dia. of 12 mm., with constant ohmic value, surrounded by highly conductive compound with high charge dissipation, suitable for the following type of applications. -Length of Pipe : 3 Mtrs. -Back filling Compound :2 nos Bags of 25 Kg.	2	13584.50	Each	27169.00
45	3-14-3.	Providing and erecting required size Copper strip for earthing of H.T. OCB / ACB/ Transformer, LT panel board, Motors etc. using copper clamp.	5	717.10	Kgs	3585.50
		Subtotal Part-04				33027.00
<b>Part-05</b>		LT Cables & Cable Termination				
		Providing and erecting XLPE(IS:7098)(I)-88 ISI armoured cable multistrand Aluminium conductor for 1.1 KV. to be laid on wall with necessary clamps or in existing trench / pipe of following size of cables				
45	4-3-3	(E) 3 1/2 core 120 Sq. mm ( 70 Sq. mm 1/2 core)	80	555.50	Mtr.	44440.00
	4-2-1.	Supplying & erecting XLPE(IS:7098)(I)-88 ISI unarmoured copper cable 1.1 KV grade to be erected as directed of following size.				
46		(L) 4 core 6 Sq. mm	360	353.50	Mtr.	127260.00
47		(M) 4 core 10 Sq. mm	120	555.50	Mtr.	66660.00
46	4-5-1	Making trench in soft soil of suitable width of 90 cms deep for laying cable or locating the fault all over the run and backfilling the same and making the surface as normal ground.	60	40.40	Mtr.	2424.00
47	4-5-7	Providing & laying. R.C.C. hume pipe for cable to be laid 90 cms. below ground across the road crossing or on floor with necessary material in an approved manner and making the ground as per original. (A) 150 mm dia	8	247.45	Mtr.	1979.60
		Providing and, fixing heavy duty flange type brass cable gland with rubber ring for PVC insulated armoured cable complete with out going tails, insulating tape etc for following size of cables.				
48	4-6-3.	(E) 3 & 1/2 core 120 Sq. mm	2	151.50	Each	303.00
	4-6-1.	Providing and, fixing heavy duty flange type brass cable gland with rubber ring for PVC insulated armoured cable complete with out going tails, insulating tape etc for following size of cables.				
49		(c) 2 to 4 core 6/10 Sq. mm	16	40.40	Each	646.40
	4-7-1.	Solderless crimping type Aluminium lugs conforming to IS suitable for cable of following size evenly crimped with high pressure tool & connected to switchgear terminals with brass/cadmium plated nut bolts in an approved manner.				
50		(H) 120 Sq.mm.	8	45.45	Each	363.60

ITEM NO	DTP NO	Description	Qty.	Rate	per	Amount
	4-7-2.	Solderless crimping type Copper lugs conforming to IS suitable for cable of following size evenly crimped with high pressure tool & connected to switchgear terminals with brass/cadmium plated nut bolts in an approved manner.				
		(A) 1.5/2.5 to 6 Sq.mm	50	8.08	Each	404.00
		(B) 10 Sq.mm	16	10.10	Each	161.60
	4-5-8.	Providing & laying approved make Double walled corrugated pipes (DWC) of polyethylene(conforming to IS 14930 II )with necessary connecting accessories of same material at required depth for laying of cable. below ground / road surface for enclosing cable and back filling the same to make ground as per original.				
51		(A)50 mm dia	270	146.45	Mtr.	39541.50
		(C)120 mm dia.	80	303.00	Mtr.	24240.00
		Subtotal Part-05				308423.70
<b>Part-06</b>		Fan & Related Accessories				
52	5-1-6.	Providing and erecting Approved make High Speed Max. 50 Watt Ceiling fan with double ball bearing ISI mark with condenser A.C. 230V.50 c/s.1200 mm. sweep complete having 3 blades with aluminium blades with canopy and 30 cms. down rod erected on existing hook or clamp with 24/0.2 , 3 core flexible wire with earthing. [Latest 5 star Rating as per list declared by BEE]	70	2090.70	Each	146349.00
53	5-2-3.	Supplying & erecting fan hook box of 10 mm M.S. round bar bounded to the RCC bars up to 50mm length each side and pierced through a 16 Gauge M.S. box / Heavy Duty PVC box complete erected concealed in Ceiling with necessary finishing.	70	126.25	Each	8837.50
54	5-3-4.	Supplying & erecting single phase approved make industrial exhaust fan suitable for medium duty ring mounted low noise operation suitable for medium duty having following dia size and maximum speed in RPM [A] 305 mm dia 900 RPM- Cat II	14	2424.00	Each	33936.00
		Subtotal Part-06				189122.50
<b>Part-07</b>		Motor & Starters, AC				
55	9-1-1-B	Supplying and erecting Direct On-line Electronics Starter with 2-5/4-10/8-14/10-16 Amp. Rating relay (variable current setting) directly operated in totally insulated elegant enclosure and 18 Amp. Rating power relay with start - stop button for single phase operation up to 3 HP as per complete erected on P.W. Block with following features. Low voltage cut off below 140 V High voltage cut off above 280 V Overload protection Indicating LEDs for motor on lv, hv & overload tripping. [Cat.II]	1	1424.10	Each	1424.10
56	9-4-2.	Providing & erecting open well horizontal mono block pump set with cast iron body, complete for three phase submersible motor having [D] For 5 HP 3 phase open well horizontal mono block pump set suitable for 1350 LPM to 310 LPM @ 10 to 42 Mtr head suitable for 50/65 mm dia delivery pipe Cat-II.	0	16816.50	Each	0.00
57	9-3-3.	Supplying & erecting approved make self-priming domestic monoblock water pump with 1.5 H.P motor, suitable for operation on 230 volts, 50c/s. AC supply with metallic flange, and M.S. impeller delivery and following discharge 44 LPM at 32 Mtr head suitable 25 mm dia delivery Cat III	1	8362.80	Each	8362.80
58	9-5-1.	Supplying & erecting approved make Automatic liquid level controller 6A.as per instruction of Engineer in charge on site complete with wiring connection with existing wires , with copper conductor from pump to upper and lower tank.	1	2525.00	Each	2525.00
59	9-7-1.	Providing and erecting ISI marked PVC insulated PVC Sheathed Flat flexible Submersible copper cable approved make of following Size. (b) 3 Core x 2.5 Sq. mm.	40	90.90	Mtr	3636.00

<b>ITEM NO</b>	<b>DTP NO</b>	<b>Description</b>	<b>Qty.</b>	<b>Rate</b>	<b>per</b>	<b>Amount</b>
<b>60</b>	<b>8-8-1.</b>	Providing & erecting water cooler having storage capacity 80 Ltr. & cooling capacity 40 Ltr.per hour @ an ambient temp of 450 C. The outlet temp. of the water should drop by 150C within a hour, The water cooler should be comprising of hermetically sealed compressor, fan motor, condensing unit, water tank surrounded by evaporating, coil, thermostats, relay etc.complete with necessary inlet & outlet connection. The body of water cooler will be made from Stainless Steel. 40 Litre Storage/80 Litre Cooling	1	36360.00	Each	<b>36360.00</b>
<b>61</b>	<b>MR</b>	SITC of Water Purifire Eureka Forbs Make AG 200 or Equivalent	1	10711.05	Each	<b>10711.05</b>
<b>62</b>	<b>8-3-1-2.</b>	Providing and erecting Inverter based approved make split air-conditioning unit consisting of condensing unit with variable speed fan motor, inverter type hermetically sealed rotary compressor with accessories etc. duly connected separately erected evaporating unit and blower motor with its accessories by means of proper insulated copper tubing up to 5 RMT suitable for (Cost includes M.S. Stand, Gas Charging & Internal Copper Wiring & Remote Control) (B) For 2 Ton Capacity	2	55550.00	Each	<b>111100.00</b>
		Subtotal Part-07				<b>174118.95</b>
		<b>Total Amount Of Electrification in Incubation Centre (Part -D)</b>				<b>2465145.18</b>
		<b>Summary</b>				
	<b>Sr.no</b>	<b>ITEM</b>		<b>Amount</b>		
	<b>A</b>	Renovation & Extention Of Incubation Center		11794432.77		
	<b>B</b>	Canteen Civil Work		4096975.99		
	<b>C</b>	Interior (Furniture & HVAC) Work		10544875.39		
	<b>D</b>	Electrification Work		2465145.18		
		<b>GRAND COST</b>		<b>28901429.33</b>		

SIGNATURE OF CONTRACTOR

EXECUTIVE ENGINEER,  
SOUTH ZONE (UDHNA),  
SURAT MUNICIPAL CORPORATION



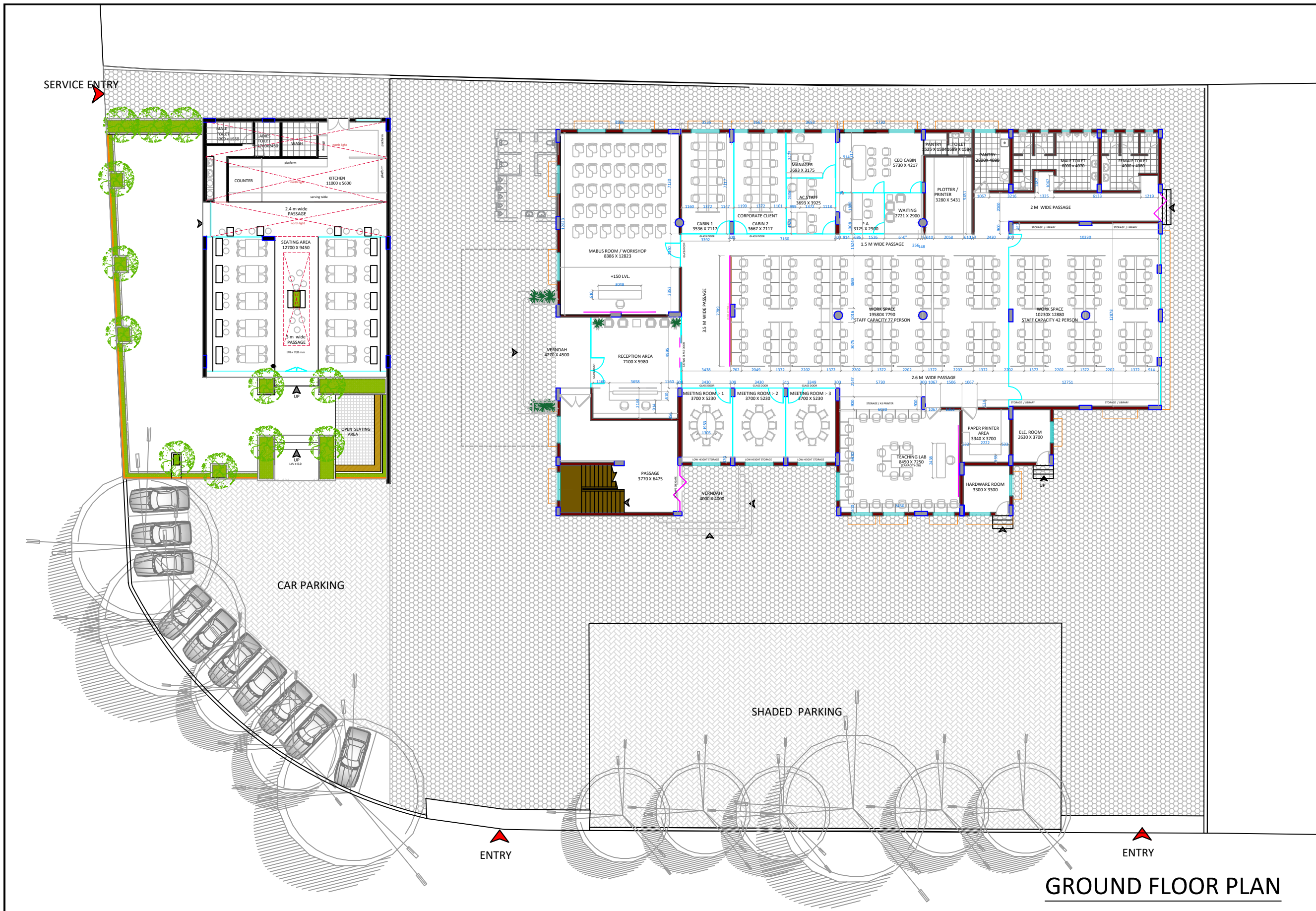

**GROUND FLOOR PLAN**

ARCHITECTURAL DETAIL FOR PROPOSED SEVA VINIMAY PROTSHAHAN KENDRA (SEPC) ON F.P. NO-79, T.P.S. NO-1, (UDHNA - MAJURA), SOUTH ZONE, SMC, SURAT.

SCALE- N.T.S.  
DT-30-11-17

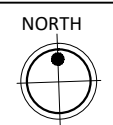

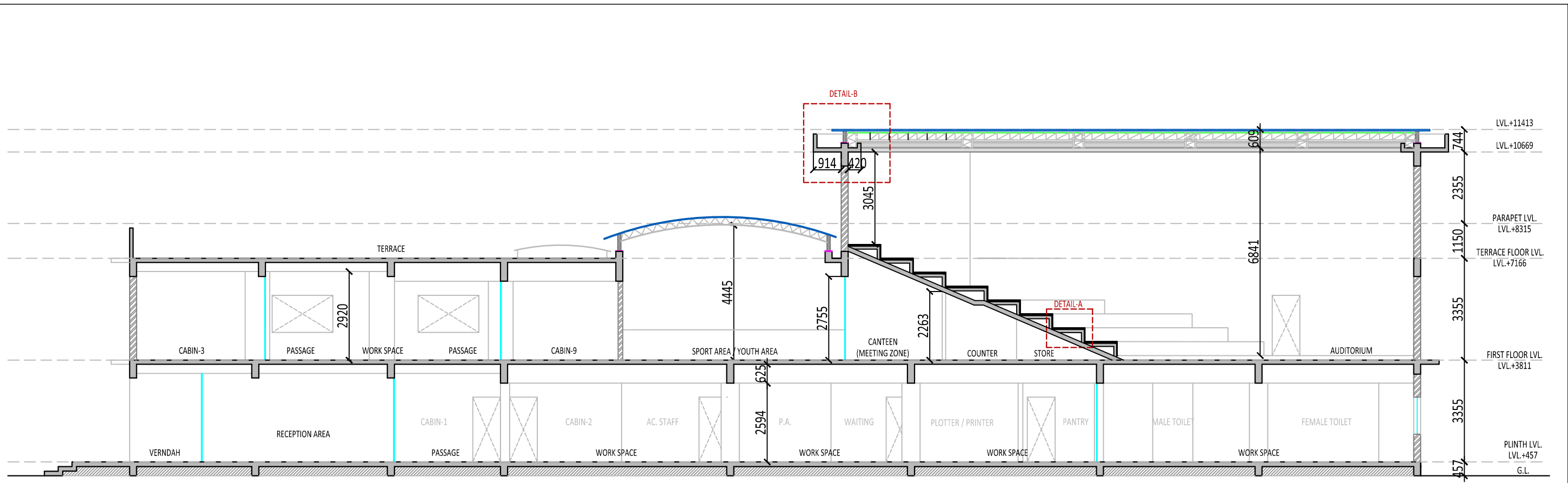

SECTION-AA'

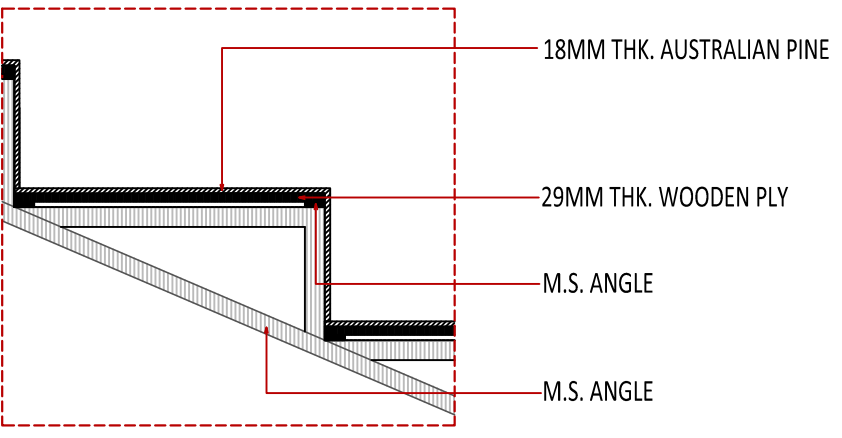

DETAIL-A

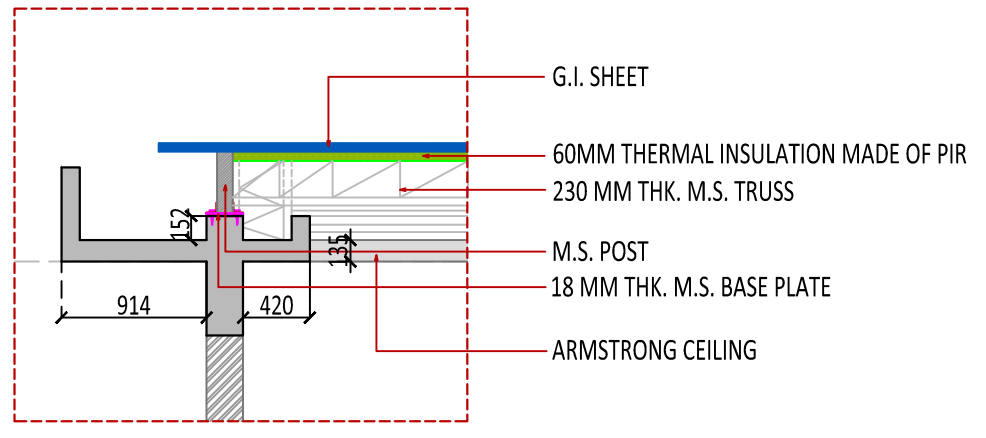

DETAIL-B

ARCHITECTURAL DETAIL FOR PROPOSED SEVA VINIMAY  
 PROTSHAHAN KENDRA (SEPC) ON F.P. NO-79, T.P.S. NO-1, (UDHNA -  
 MAJURA), SOUTH ZONE, SMC, SURAT.

SCALE- N.T.S.  
 DWG. BY-HARSHIL  
 DT-6-1-18

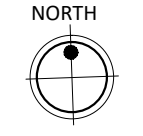

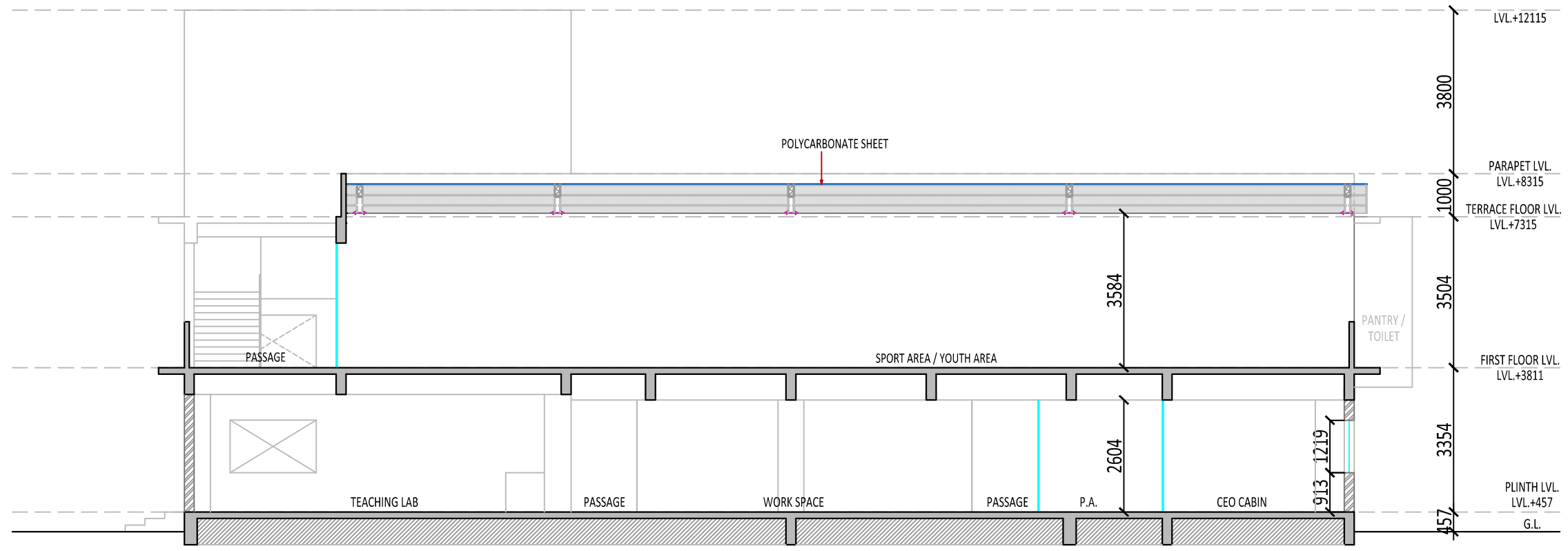

SECTION-BB'

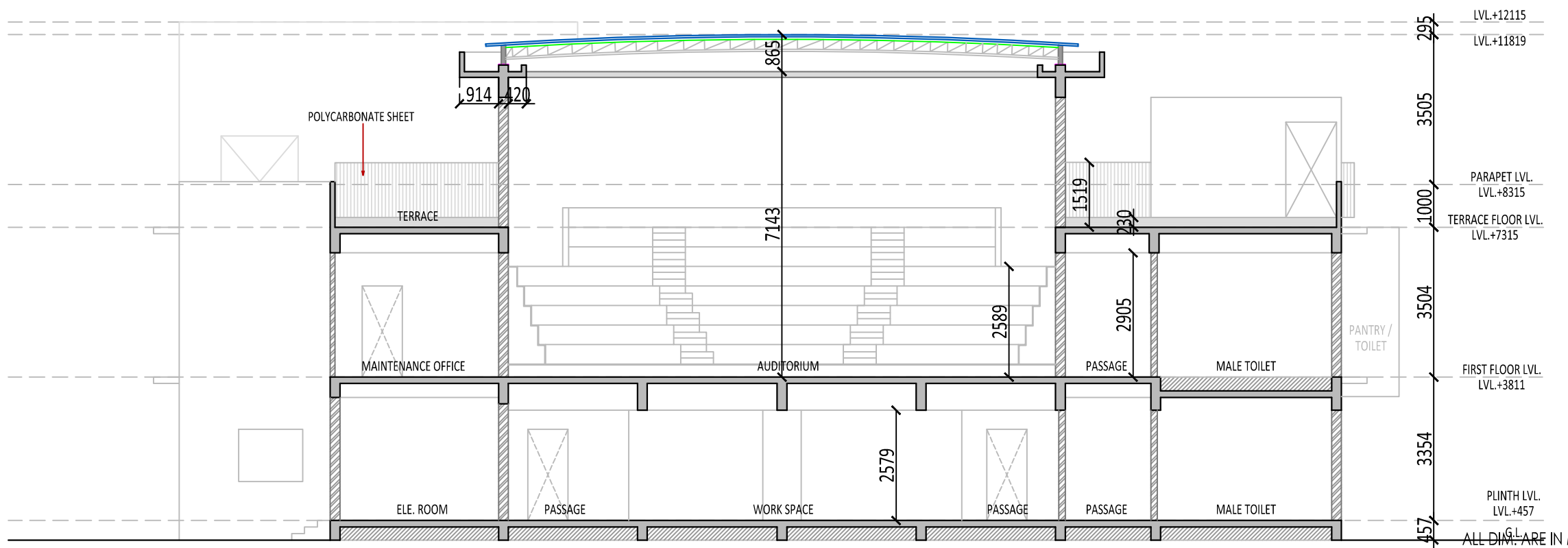

SECTION-CC'

ARCHITECTURAL DETAIL FOR PROPOSED SEVA VINIMAY  
 PROTSHAHAN KENDRA (SEPC) ON F.P. NO-79, T.P.S. NO-1, (UDHNA -  
 MAJURA), SOUTH ZONE, SMC, SURAT.

SCALE- N.T.S.  
 DWG. BY-HARSHIL  
 DT-6-1-18

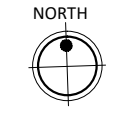

ALL DIM. ARE IN MM.

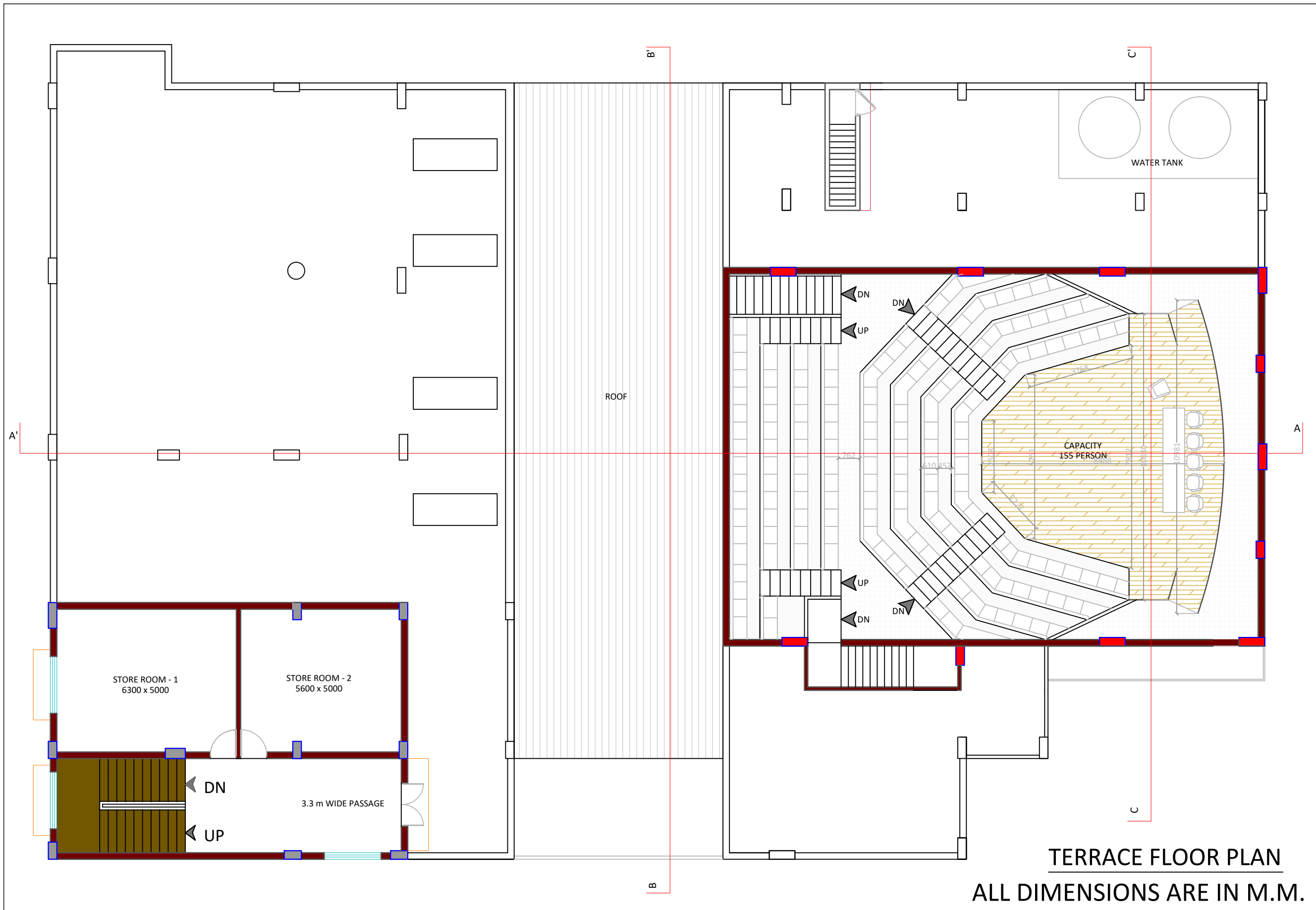

**TERRACE FLOOR PLAN**  
**ALL DIMENSIONS ARE IN M.M.**

ARCHITECTURAL DETAIL FOR PROPOSED SEVA VINIMAY PROTSHAHAN  
 KENDRA (SEPC) ON F.P. NO-79, T.P.S. NO-1, (UDHNA - MAJURA), SOUTH  
 ZONE, SMC, SURAT.

SCALE- N.T.S.  
 DT-23-11-17

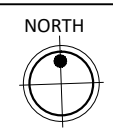



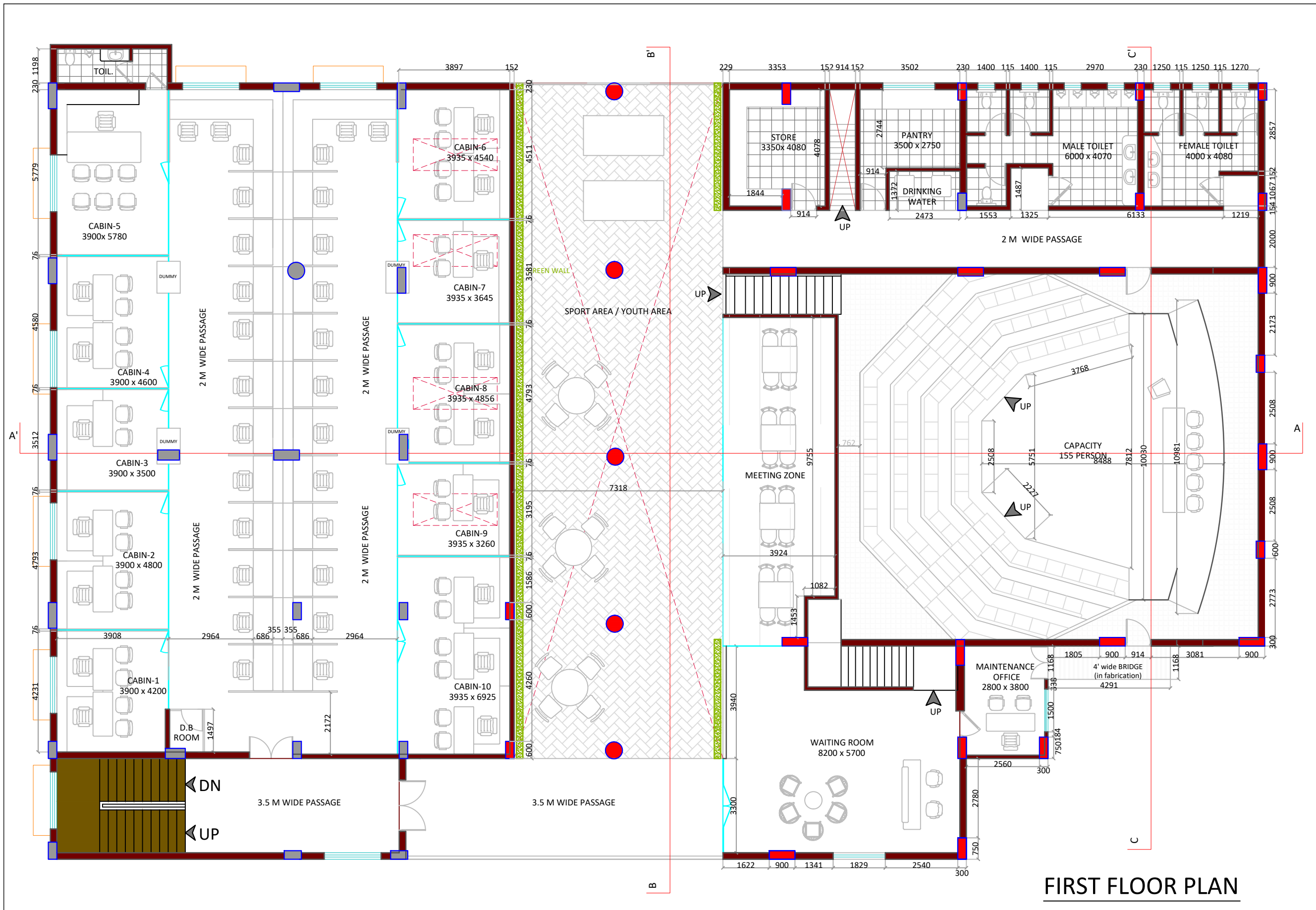

**FIRST FLOOR PLAN**

ARCHITECTURAL DETAIL FOR PROPOSED SEVA VINIMAY PROTSHAHAN KENDRA (SEPC) ON F.P. NO-79, T.P.S. NO-1, (UDHNA - MAJURA), SOUTH ZONE, SMC, SURAT.

SCALE- N.T.S.  
DT-23-11-17

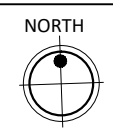

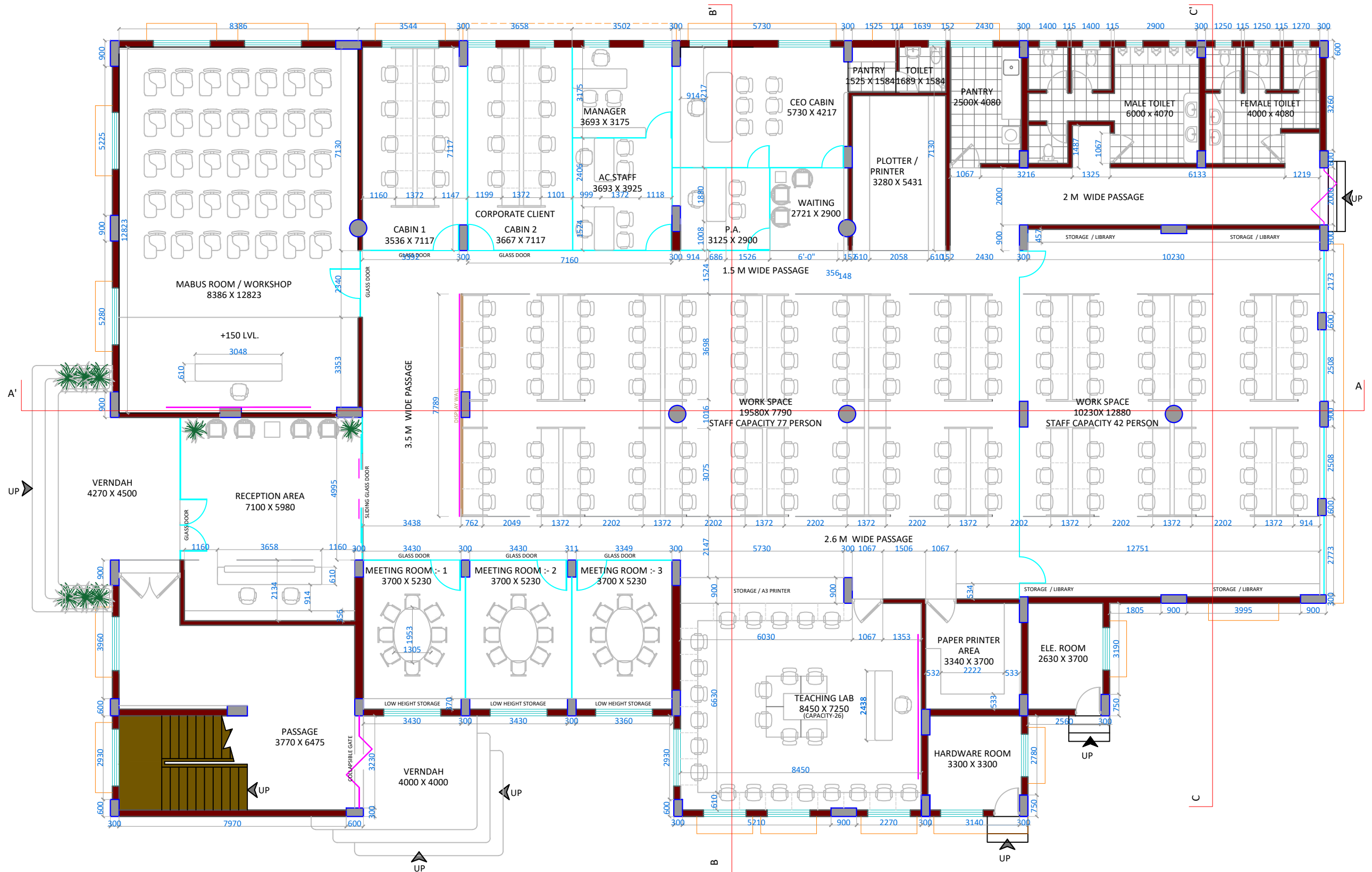

**GROUND FLOOR PLAN**

ARCHITECTURAL DETAIL FOR PROPOSED SEVA VINIMAY PROTSHAHAN KENDRA (SEPC) ON F.P. NO-79, T.P.S. NO-1, (UDHNA - MAJURA), SOUTH ZONE, SMC, SURAT.

SCALE- N.T.S.  
DT-23-11-17



IITATHASTUII  
ARCHITECTS







**SURAT MUNICIPAL CORPORATION  
SOUTH ZONE (UDHNA)**

**NAME OF WORK: CONSTRUCTION OF INNOVATION, INCUBATION, START UP AND TRADE FACILITATION CENTRE UNDER SMART CITY MISSION (PHASE-1) AT EXISTING SEPC BUILDING AT T.P. SCHEME NO.1 (UDHNA-MAJURA), F.P. NO.79 IN SOUTH ZONE (UDHNA), SURAT**

REF: - TENDER NOTICE (ON LINE) NO.: **SSCDL-TEN-02-2017-18**  
Tender ID No. - 298373

**ERRATA, ADDENDA AND CORRIGENDUM - 1**

1. The tenderer are requested to make note of the following changes made in the tender documents, which are to be taken into account while submitting the tender. They shall be presumed to have done so and accordingly submitted the tender.
2. This errata, addenda and corrigendum shall be treated as a part of the tender documents. All the errata, addenda, corrigendum issued by this office along with enclosure must be signed on each and every page towards the acceptance of the same and its hard copy must be sent along with technical bid duly signed and sealed.
3. All the items, conditions, etc. given in the Errata, Addenda and Corrigendum supersedes relevant items, conditions etc. to that effect as provided in the original tender documents.
4. The tender document along with addenda, errata and corrigendum 1 to be submitted in hard copy duly sealed & signed by contractor within stipulated time of physical submission of the tender document.
5. Last date of online Submission is extended upto **05-03-2018** upto 1800 hrs. and last date for submission of hard copies to Chief Accountant's office upto **08-03-2018** up to 1800 hrs.
6. Time limit for completion of work is revised. Tenderer shall read time limit for completion of work as **04 (Four) months (Excluding Monsoon) instead of 06 (Six) months (Excluding Monsoon).**
7. **All other terms and conditions of the works etc. are unchanged.**

S/d-  
**Dy. Mun. Commissioner**  
**Surat Municipal Corporation.**

**SIGNATURE AND SEAL OF TENDERER:-**

**ADDRESS:**

