

**SMART KALYAN-DOMBIVLI
DEVELOPMENT CORPORATION LIMITED (SKDCL)**

REQUEST FOR PROPOSAL

Tender No. _____

**UPGRADATION OF KALYAN MURBAD ROAD FROM KDMT
BUS DEPOT TO KARNIK ROAD INTO PEDESTRIAN
FRIENDLY SMART ROAD**

Date: 5TH June 2017

National Competitive Bidding

(CIVIL WORKS)

NAME OF WORK: As mentioned in Tender Notice

PERIOD OF SALE OF BIDDING DOCUMENT: As mentioned in Tender Notice

LAST DATE AND TIME FOR RECEIPT OF BID: As mentioned in Tender Notice

TIME AND DATE OF OPENING TECHNICAL AND FINANCIAL BID: As mentioned in Tender Notice

PLACE OF OPENING OF BIDS: As mentioned in Tender Notice

OFFICER INVITING BIDS

INVITATION FOR BID

(IFB)

INSTRUCTIONS TO BIDDERS

A. GENERAL

1. Scope of Bid

- 1.1. The Employer (named in Appendix to ITB) invites bids for the Upgradation of KalyanMurbad Road from KDMT Bus Depotto Karnik road as pedestrian friendly smart road (as defined in these documents and referred to as "the works") detailed in the table given in IFB. The bidders may submit bids for any or all of the works detailed in the table given in IFB.
- 1.2. The successful bidder will be expected to complete the works by the intended completion date specified in the Contract data.
- 1.3. Throughout these bidding documents, the terms `bid' and `tender' and their derivatives (bidder/ tenderer, bid/ tender, bidding! tendering, etc.) are synonymous.

2. Source of Funds

- 2.1. The expenditure on this project will be met from the budget of Smart KalyanDombivli Corporation Limited.

3. Eligible Bidders

- 3.1. Bidders that are Government-owned enterprises or institutions in the India may participate only if they can establish that they
 - a. are legally and financially autonomous
 - b. operate under commercial law, and
 - c. Are not dependent agencies of the Employer to be eligible, a government-owned enterprise or institution shall establish to the Employer's satisfaction, through all relevant documents, including its Charter and other information the Employer may request, that it: (i) is a legal entity separate from the government (ii) does not currently receive substantial subsidies or budget support; (iii) operates like any commercial enterprise, and, inter alia, is not obliged to pass on its surplus to the government (GoI or State Govt.(s)), can acquire rights and liabilities, borrow funds and be liable for repayment of its debts, and can be declared bankrupt; and (iv) is not bidding for a contract to be awarded by the department or agency of the government(GoI or State Govt.) which under their applicable laws or regulations is the reporting or supervisory authority of the enterprise or has the ability to exercise influence or control over the enterprise or institution.
- 3.2. All bidders shall provide in Section 2, Forms of Bid and Qualification Information, a statement that the Bidder is neither associated, nor has been associated, directly or indirectly, with the Consultant or any other entity that has prepared the design, specifications, and other documents for the Project or being proposed as Project Manager for the Contract. A firm that has been engaged by the Employer to provide consulting services for the preparation or supervision of the works, and any of its affiliates, shall not be eligible to bid.

4. Qualification of the Bidder

4.1. All bidders shall provide in Section 2, Forms of Bid and Qualification Information, a preliminary description of the proposed work method and schedule, including drawings and charts, as necessary. The proposed methodology should include program of construction backed with equipment planning and deployment duly supported with broad calculations and quality assurance procedures proposed to be adopted justifying their capability of execution and completion of work as per technical specifications, within stipulated period of completion.

4.2. Deleted

4.3. All bidders shall include the following information and documents with their bids in Section 2:

- a) copies of original documents defining the constitution or legal status, place of registration, and principal place of business; written power of attorney of the signatory of the Bid to commit the Bidder;
- b) experience in works of a similar nature and size for each of the last five years, and details of works underway or contractually committed; and
- c) reports on the financial standing of the Bidder, such as profit and loss statements and auditor's reports for the past five years;
- d) Undertaking that the bidder will be able to invest a minimum cash upto 25% of contract value of work, during implementation of work.
- e) information regarding any litigation, current or during the last five years, in which the Bidder is involved, the parties concerned, and disputed amount;
- f) the proposed methodology and program of construction, backed with equipment planning and deployment, duly supported with broad calculations and quality control procedures proposed to be adopted, justifying their capability of execution and completion of the work as per technical specifications within the stipulated period of completion as per milestones.

4.4. Bids from Joint ventures or consortium are not acceptable.

4.5. A. To qualify for award of the contract, each bidder in its name should have in the last five years as referred to in Appendix.

- a) achieved a minimum annual financial turnover from civil engineering construction works only for an amount indicated in Appendix in any one year;
- b) Satisfactorily completed, as a prime contractor minimum 2 completed projects of roadworks along with construction of footpaths of at least 500 m length.

B. delete

C. delete

4.6. delete

4.7. delete

- 4.8. Even though the bidders meet the above qualifying criteria, they are subject to be disqualified if they have:
- a) made misleading or false representations in the forms, statements and attachments submitted in proof of the qualification requirements; and/or
 - b) record of poor performance such as abandoning the works, not properly completing the contract, inordinate delays in completion, litigation history, or financial failures etc.; and/or
 - c) Participated in the previous bidding for the same work and had quoted unreasonably high bid prices and could not furnish rational justification to the employer.

5. One Bid per Bidder

5.1. Each bidder shall submit only one bid for one package. A bidder who submits or participates in more than one Bid will cause all the proposals with the Bidder's participation to be disqualified.

6. Cost of Bidding

6.1. The bidder shall bear all costs associated with the preparation and submission of his Bid, and the Employer will in no case be responsible and liable for those costs.

7. Site Visit

7.1. The Bidder, at the Bidder's own responsibility and risk is encouraged to visit and examine the Site of Works and its surroundings and obtain all information that may be necessary for preparing the Bid and entering into a contract for construction of the Works. The costs of visiting the Site shall be at the Bidder's own expense.

B. BIDDING DOCUMENTS

8. Content of Bidding Documents

8.1. The set of bidding documents comprises the documents listed below and addenda issued in accordance with Clause 10:

Section	Particulars	Volume No.
	Invitation for Bids (Tender Notice)	
1	Instructions to Bidders	I
2	Qualification Information, and other forms	
3	Conditions of Contract	
4	Contract Data	
5	Technical Specifications	II
6	Form of bid	III
7	Bill of Quantities	
8	Securities and other forms	
9	Drawings	IV
10	Documents to be furnished by bidder	V

- 8.2. One copy of each of the volumes I, II, III and IV will be issued to the bidder. Documents to be furnished by the bidder in compliance to section 2 will be prepared by him and furnished as Volume-V in two parts (refer clause 12).
- 8.3. The bidder is expected to examine carefully all instructions, conditions of contract, contract data, forms, terms, technical specifications, bill of quantities, forms, Annexes and drawings in the Bid Document. Failure to comply with the requirements of Bid Documents shall be at the bidder's own risk. Pursuant to clause 26 hereof, bids which are not substantially responsive to the requirements of the Bid Documents shall be rejected.

9. Clarification of Bidding Documents

- 9.1. A prospective bidder requiring any clarification of the bidding documents may notify the Employer in writing or by email at the Employer's address and mail id indicated in the invitation to bid. The Employer will respond to any request for clarification which he received earlier than 7 days prior to the deadline for submission of bids. Copies of the Employer's response will be forwarded to all purchasers of the bidding documents, including a description of the enquiry but without identifying its source.

9.2. Deleted

10. Amendment of Bidding Documents

- 10.1. Before the deadline for submission of bids, the Employer may modify the bidding documents by issuing addenda.
- 10.2. Any addendum thus issued shall be part of the bidding documents and shall be communicated in writing or by cable to all the purchasers of the bidding documents. Prospective bidders shall acknowledge receipt of each addendum in writing or by cable to the Employer. The Employer will assume no responsibility for postal delays.
- 10.3. To give prospective bidders reasonable time in which to take an addendum into account in preparing their bids, the Employer may, at his discretion, extend as necessary the deadline for submission of bids, in accordance with Sub-Clause 20.2 below.

C. PREPARATION OF BIDS

11. Language of the Bid

11.1. All documents relating to the bid shall be in the English language.

12. Documents Comprising the Bid

12.1. The bid to be submitted by the bidder as Volume V of the bid document (refer Clause 8.1) shall be in two separate parts:

Part I shall be named "Technical Bid" and shall comprise

- a) Bid Security in the form specified in Section 8
- b) Qualification Information and supporting documents as specified in Section 2
- c) Certificates, undertakings, affidavits as specified in Section 2
- d) Any other information pursuant to Clause 4.2 of these instructions
- e) Undertaking that the bid shall remain valid for the period specified in Clause 15.1
- f) Acceptance/ non-acceptance of Dispute Review Expert proposed in Clause 36.1

Part II shall be named "Financial Bid" and shall comprise

- a) Form of Bid as specified in Section 6
- b) Priced Bill of Quantities for items specified in Section 7

The Technical and the Financial Bid shall be uploaded on www.mahatenders.gov.in as per Instructions in Clause 19.

12.2. Delete.

12.3. Following documents, which are not submitted with the bid, will be deemed to be part of the bid.

Section	Particulars	Volume No.
	Invitation for Bids	I
1	Instructions to Bidders	
3	Conditions of Contract	
4	Contract Data	
5	Technical Specifications	II
9	Drawings	IV

13. Bid Prices

- 13.1. The contract shall be for the whole works as described in Sub-Clause 1.1, based on the priced Bill of Quantities submitted by the Bidder.
- 13.2. The bidder shall fill in rates and prices and line item total (both in figures and words) for all items of the Works described in the Bill of Quantities along with total bid price (both in figures and words). Items for which no rate or price is entered by the bidder will not be paid for by the Employer when executed and shall be deemed covered by the other rates and prices in the Bill of Quantities. Corrections, if any, shall be made by crossing out, initialing, dating and rewriting.
- 13.3. All duties, taxes, and other levies payable by the contractor under the contract, or for any other cause shall be included in the rates, prices and total Bid Price submitted by the Bidder.
- 13.4. The rates and prices quoted by the bidder shall be fixed for the duration of the Contract and shall not be subject to adjustment on any account.

14. Currencies of Bid and Payment

- 14.1. The unit rates and the prices shall be quoted by the bidder entirely in Indian Rupees. All payments shall be made in Indian Rupees.

15. Bid Validity

- 15.1. Bids shall remain valid for a period not less than 120 days after the deadline date for bid submission specified in Clause 20. A bid valid for a shorter period shall be rejected by the Employer as non-responsive. In case of discrepancy in bid validity period between that given in the undertaking pursuant to Clause 12.1 (v) and the Form of Bid submitted by the bidder, the latter shall be deemed to stand corrected in accordance with the former and the bidder has to provide for any additional security that is required.
- 15.2. In exceptional circumstances, prior to expiry of the original time limit, the Employer may request that the bidders may extend the period of validity for a specified additional period. The request and the bidders' responses shall be made in writing or by cable. A bidder may refuse the request without forfeiting his bid security. A bidder agreeing to the request will not be required or permitted to modify his bid except as provided in 15.3 hereinafter, but will be required to extend the validity of his bid security for a period of the extension, and in compliance with Clause 16 in all respects.
- 15.3. In the case of contracts in which the Contract Price is fixed, in the event that the Employer requests and the Bidder agrees to an extension of the validity period, the contract price, if the Bidder is selected for award shall be the bid price corrected as follows :

The price shall be increased by the factor of 0.2% for each week or part of a week that has elapsed from the expiration of the initial bid validity to the date of issue of letter of acceptance to the successful Bidder.

15.4. Bid evaluation will be based on the bid prices without taking into consideration the above correction.

16. Bid Security

16.1. The Bidder shall furnish, as part of his Bid, a Bid security in the amount as shown in table of IFB for this particular work. This bid security shall be in favor of Employer as named in Appendix and be in the following form:

a) Online through net banking facility

16.2. Bank guarantees (and other instruments having fixed validity) issued as surety for the bid shall be valid for 45 days beyond the validity of the bid.

16.3. Any bid not accompanied by an acceptable Bid Security and not secured as indicated in Sub-Clauses 16.1 and 16.2 above shall be rejected by the Employer as non-responsive.

16.4. The Bid Security of unsuccessful bidders will be returned within 28 days of the end of the bid validity period specified in Sub-Clause 15.1.

16.5. The Bid Security of the successful bidder will be discharged when the bidder has signed the Agreement and furnished the required Performance Security.

16.6. The Bid Security may be forfeited

- a) if the Bidder withdraws the Bid after Bid opening during the period of Bid validity;
- b) if the Bidder does not accept the correction of the Bid Price, pursuant to
- c) in the case of a successful Bidder, if the Bidder fails within the specified time limit to:
 - i. sign the Agreement; or
 - ii. Furnish the required Performance Security.

17. Alternative Proposals by Bidders

17.1. Bidders shall submit offers that fully comply with the requirements of the bidding documents, including the conditions of contract, basic technical design as indicated in the drawing and specifications. Conditional offer or alternative offers will not be considered further in the process of tender evaluation.

18. Format and Signing of Bid

18.1. The bidder shall prepare the documents as per the formats provided in the Section II.

18.2. The bid document shall be typed or written in indelible ink and shall be signed by a person or persons duly authorized to sign on behalf of the Bidder, pursuant to Sub-Clauses 4.3. All pages of the bid where entries or amendments have been made shall be initialed by the person or persons signing the bid.

18.3. The Bid shall contain no alterations or additions, except those to comply with instructions issued by the Employer, or as necessary to correct errors made by the bidder, in which case such corrections shall be initialed by the person or persons signing the bid.

D. SUBMISSION OF BIDS

19. Online Submission through e-tendering

19.1. The blank tender forms are available at www.mahatenders.gov.in. The procedure for purchasing the blank tender form is as follows.

- a) Applicant who wish to participate in the bidding process must register on the website <http://mahatenders.gov.in/nicgep/app>. Applicants, whose registration is valid, may please ignore this step. At the time of enrollment, the information required for enrollment should be filled. After enrollment the bidder will get his user name and password to his Mail Id. All the contractors registered in appropriate class and willing to participate in e-tendering process shall enroll their name/ Firm on the e- tendering portal for download of tender documents etc. ;
- b) To participate in the online Tendering process, the Applicants must procure Digital Signature Certificates (DSC: class II or class III) obtained from any Certifying Authorities in accordance with the IT Act 2000. Applicants who already have a valid DSC need not procure a new DSC. In case of requirement of DSC, interested Applicants should go to <http://mahatenders.gov.in> and follow the procedure mentioned in the document 'Procedure for application of Digital Certificate';
- c) A digital signature is required for purchasing and submission of Tender form. Queries regarding digital signature can be solved through help mode, bidder can contact Help Line No. 1800 233 7315;
- d) Tender form, conditions of contract, specifications can be downloaded from the e-Tendering portal of Government of Maharashtra i.e. ‘ <http://mahatenders.gov.in> ’;
- e) The bidder has to submit Earnest Money Deposit and Tender form fee (Non Refundable) for this work by making payment online as per the IFB;
- f) The Bidder shall submit the offer in Electronic formats both for technical and commercial proposals;
- g) The bidder has to submit the technical and commercial bid online only;
- h) Tender is to be submitted as per enclosed "Financial Form format" only;
- i) Attach the certificates, brochures & other documents asked for in the tender. The Contractors may obtain the necessary information on the process of enrolment and empanelment either from Helpdesk Support Team or may visit the information published under the link Enroll under the section E-Tendering Toolkit for Applicants on the Home Page of the Electronic Tendering System;
- j) For any other queries, bidder can contact Help Line No. 1800 233 7315;
- k) Further information regarding the work can be obtained from the Executive Engineer’s office, KDMC;
- l) The procedure for application of a Digital Signature Certificate will remain the same for the new Authorized Certificate. The same procedure holds true for the Authorized Users in a Private / Public Limited Company. In this case, the Authorization Certificate will have to be signed by the Director of the Company or the Reporting Authority of the Applicant. To operate on the Electronic Tendering System of Maharashtra, the Computer System of the Contractors is required be set up. The Contractors are required to install Utilities available under the section Mandatory Installation Components on the Home Page of the System. The Utilities are available for download freely from the above mentioned section. The Contractors are requested to refer to the E-Tendering Toolkit for Applicants

available online on the Home Page to understand the process of setting up the System, or alternatively, contact the Helpdesk Support Team on information / guidance on the process of setting up the System. The Bidders are advised to have adequate time buffer to upload the documents online to avoid technical difficulties.

20. Deadline for Submission of the Bids

20.1. Complete Bids (including Technical and Financial) must be uploaded on www.mahatenders.gov.in not later than the date indicated in appendix. In the event of the specified date for the submission of bids declared a holiday for the Employer, the Bids will be received up to the appointed time on the next working day.

20.2. The Employer may extend the deadline for submission of bids by issuing an amendment in accordance with Clause 10, in which case all rights and obligations of the Employer and the bidders previously subject to the original deadline will then be subject to the new deadline.

21. Delete

22. Delete

E. BID OPENING AND EVALUATION

23. Bid Opening

- 23.1. The Employer will open all the Bids received (except those received late), in the presence of the Bidders or their representatives who choose to attend at time, date and the place specified in Appendix in the manner specified in Clause 20 and 23.3. In the event of the specified date of Bid opening being declared a holiday for the Employer, the Bids will be opened at the appointed time and location on the next working day.
- a) Subject to confirmation of the bid security by the issuing Bank, the bids accompanied with valid bid security will be taken up for evaluation with respect to the Qualification Information and other information furnished in Part I of the bid pursuant to Clause 12.1.
 - b) After receipt of confirmation of the bid security, the bidder will be asked
 - c) In writing (usually within 10 days of opening of the Technical Bid) to clarify or modify his technical bid, if necessary, with respect to any rectifiable defects.
 - d) The bidders will respond in not more than 7 days of issue of the clarification letter, which will also indicate the date, time and venue of opening of the Financial Bid (usually on the 21st day of opening of the Technical Bid)
 - e) Immediately (usually within 3 or 4 days), on receipt of these clarifications the Evaluation Committee will finalize the list of responsive bidders whose financial bids are eligible for consideration.
- 23.2. Delete.
- 23.3. Delete.
- 23.4. delete
- 23.5. At the time of opening of "Financial Bid", the names of the bidders were found responsive in accordance with Clause 23.4(iv) will be announced. The bids of only these bidders will be opened. The remaining bids will be returned to the bidders unopened. The responsive Bidders' names, the Bid prices, the total amount of each bid, any discounts, Bid Modifications and withdrawals, and such other details as the Employer may consider appropriate, will be announced by the Employer at the opening. .
- 23.6. In case bids are invited in more than one package, the order for opening of the "Financial Bid" shall be that in which they appear in the "Invitation For Bid".
- 23.7. The Employer shall prepare minutes of the Bid opening, including the information disclosed to those present in accordance with Sub-Clause 23.6.

24. Process to be Confidential

- 24.1. Information relating to the examination, clarification, evaluation, and comparison of Bids and recommendations for the award of a contract shall not be disclosed to Bidders or any other persons not officially concerned with such process until the award to the successful Bidder has been announced. Any effort by a Bidder to influence the Employer's processing of Bids or award decisions may result in the rejection of his Bid.

25. Clarification of Financial Bids

- 25.1. To assist in the examination, evaluation, and comparison of Bids, the Employer may, at his discretion, ask any Bidder for clarification of his Bid, including breakdowns of unit rates. The request for clarification and the response shall be in writing or by cable, but no change in the price or substance of the Bid shall be sought, offered, or permitted except as required to confirm the correction of arithmetic errors discovered by the Employer in the evaluation of the Bids in accordance with Clause
- 25.2. Subject to sub-clause 25.1, no Bidder shall contact the Employer on any matter relating to his bid from the time of the bid opening to the time the contract is awarded. If the Bidder wishes to bring additional information to the notice of the Employer, it should do so in writing.
- 25.3. Any effort by the Bidder to influence the Employer in the Employer's bid evaluation, bid comparison or contract award decisions may result in the rejection of the Bidders' bid.

26. Examination of Bids and Determination of Responsiveness

- 26.1. During the detailed evaluation of "Technical Bids", the Employer will determine whether each Bid (a) meets the eligibility criteria defined in Clause 3 and 4; (b) has been properly signed; (c) is accompanied by the required securities and; (d) is substantially responsive to the requirements of the Bidding documents. During the detailed evaluation of the "Financial Bid", the responsiveness of the bids will be further determined with respect to the remaining bid conditions, i.e., priced bill of quantities, technical specifications, and drawings.
- 26.2. A substantially responsive "Financial Bid" is one which conforms to all the terms, conditions, and specifications of the Bidding documents, without material deviation or reservation. A material deviation or reservation is one (a) which affects in any substantial way the scope, quality, or performance of the Works; (b) which limits in any substantial way, inconsistent with the Bidding documents, the Employer's rights or the Bidder's obligations under the Contract; or (c) whose rectification would affect unfairly the competitive position of other Bidders presenting substantially responsive Bids.
- 26.3. If a "Financial Bid" is not substantially responsive, it will be rejected by the Employer, and may not subsequently be made responsive by correction or withdrawal of the non-conforming deviation or reservation.

27. Correction of Errors

- 27.1. "Financial Bids" determined to be substantially responsive will be checked by the Employer for any arithmetic errors. Errors will be corrected by the Employer as follows:
- a) where there is a discrepancy between the rates in figures and in words, the rate in words will govern; and
 - b) Where there is a discrepancy between the unit rate and the line item total resulting from multiplying the unit rate by the quantity, the unit rate as quoted will govern.
- 27.2. The amount stated in the "Financial Bid" will be corrected by the Employer in accordance with the above procedure and the bid amount adjusted with the concurrence of the Bidder in the following manner:
- a) If the Bid price increases as a result of these corrections, the amount as stated in the bid will be the 'bid price' and the increase will be treated as rebate;
 - b) If the bid price decreases as a result of the corrections, the decreased amount will be treated as the 'bid price'. Such adjusted bid price shall be considered as binding upon the Bidder. If the Bidder does not accept the corrected amount the Bid will be rejected, and the Bid security may be forfeited in accordance with Sub-Clause 16.6 (b).

28. Deleted

29. Evaluation and Comparison of Financial Bids

- 29.1. The Employer will evaluate and compare only the Bids determined to be substantially responsive in accordance with Sub-Clause 26.2.
- 29.2. In evaluating the Bids, the Employer will determine for each Bid the evaluated Bid Price by adjusting the Bid Price as follows:
- a) making any correction for errors pursuant to Clause 27; or
 - b) making an appropriate adjustments for any other acceptable variations, deviations; and
 - c) making appropriate adjustments to reflect discounts or other price modifications offered in accordance with Sub-Clause 23.6.
- 29.3. The Employer reserves the right to accept or reject any variation or deviation. Variations and deviations and other factors, which are in excess of the requirements of the Bidding documents or otherwise result in unsolicited benefits for the Employer shall not be taken into account in Bid evaluation.
- 29.4. The estimated effect of the price adjustment conditions under Clause 47 of the Conditions of Contract, during the period of implementation of the Contract, will not be taken into account in Bid evaluation.
- 29.5. If the Bid of the successful Bidder is seriously unbalanced in relation to the Engineer's estimate of the cost of work to be performed under the contract, the Employer may require the Bidder to produce detailed price analyses for any or all items of the Bill of Quantities, to demonstrate the internal consistency of those prices with the construction methods and schedule proposed. After evaluation of the price analyses, the Employer may require that the amount of the performance security set forth in

Clause 34 be increased at the expense of the successful Bidder to a level sufficient to protect the Employer against financial loss in the event of default of the successful Bidder under the Contract.

- 29.6. A bid which contains several items in the Bill of Quantities which are unrealistically priced low and which cannot be substantiated satisfactorily by the bidder, may be rejected as non-responsive.

30. Deleted

F. AWARD OF CONTRACT

31. Award Criteria

- 31.1. Subject to Clause 32, the Employer will award the Contract to the Bidder whose Bid has been determined
- a) to be substantially responsive to the Bidding documents and who has offered the lowest evaluated Bid Price; and
- 31.2. In no case, the contract shall be awarded to any bidder whose available bid capacity is less than the evaluated bid price, even if the said bid is the lowest evaluated bid. The contract will in such cases be awarded to the next lowest bidder at his evaluated bid price.

32. Employer's Right to Accept any Bid and to Reject any or all Bids

- 32.1. Notwithstanding Clause 31, the Employer reserves the right to accept or reject any Bid, and to cancel the Bidding process and reject all Bids, at any time prior to the award of Contract, without thereby incurring any liability to the affected Bidder or Bidders or any obligation to inform the affected Bidder or Bidders of the grounds for the Employer's action.

33. Notification of Award and Signing of Agreement

- 33.1. The Bidder whose Bid has been accepted will be notified of the award by the Employer prior to expiration of the Bid validity period by mail or facsimile by registered letter. This letter (hereinafter and in the Conditions of Contract called the "Letter of Acceptance") will state the sum that the Employer will pay the Contractor in consideration of the execution, completion, and maintenance of the Works by the Contractor as prescribed by the Contract (hereinafter and in the Contract called the "Contract Price").
- 33.2. The notification of award will constitute the formation of the Contract, subject only to the furnishing of a performance security in accordance with the provisions of Clause 34.
- 33.3. The Agreement will incorporate all agreements between the Employer and the successful Bidder. It will be signed by the Employer and sent to the successful Bidder, within 28 days following the notification of award along with the Letter of Acceptance. Within 21 days of receipt, the successful Bidder will sign the Agreement and deliver it to the Employer.
- 33.4. Upon the furnishing by the successful Bidder of the Performance Security, the Employer will promptly notify the other Bidders that their Bids have been unsuccessful.

34. Performance Security

- 34.1. Within 21 days of receipt of the Letter of Acceptance, the successful Bidders shall deliver to the Employer a Performance Security in any of the forms given below for an amount equivalent to 5% of the Contract price plus additional security for unbalanced Bids in accordance with Clause 29.5 of ITB and Clause 52 of Conditions of Contract:
- a) Bank guarantee in the form given in Section 8; or
 - b) Certified Cheque / Bank Draft as indicated in Appendix.
- 34.2. If the performance security is provided by the successful Bidder in the form of a Bank Guarantee, it shall be issued either (a) at the Bidder's option, by a Nationalized/Scheduled Indian bank or (b) by a foreign bank located in India and acceptable to the Employer .
- 34.3. Failure of the successful Bidder to comply with the requirements of Sub-Clause 34.1 shall constitute sufficient grounds for cancellation of the award and forfeiture of the Bid Security.

35. Advance Payment and Security

- 35.1. The Employer shall not provide any Advance Payment.

36. Dispute Review Expert

- 36.1. The Employer proposes that [name of proposed Dispute Review Expert as indicated in Appendix] be appointed as Dispute Review Expert under the Contract. If the Bidder disagrees with this proposal, the Bidder should so state in the Bid. If in the Letter of Acceptance, the Employer has not agreed on the appointment of the Dispute Review Expert, the Dispute Review Expert shall be appointed by the Council of Indian Roads Congress at the request of either party.

37. Corrupt or Fraudulent Practices

- 37.1. The Employer will reject a proposal for award if it determines that the Bidder recommended for award has engaged in corrupt or fraudulent practices in competing for the contract in question and will declare the firm ineligible, either indefinitely or for a stated period of time, to be awarded a contract with National Highways Authority of India I State PWD and any other agencies, if it at any time determines that the firm has engaged in corrupt or fraudulent practices in competing for the contractor, or in execution.
- 37.2. Furthermore, Bidders shall be aware of the provision stated in Sub-Clause 23.2 and Sub-Clause 59.2 of the Conditions of Contract.

Appendix to ITB

Reference clause to section I	
1.1	Name of the Employer is: Smart KalyanDombivli Corporation Limited
4.5 A	To qualify for award of the contract, each bidder in its name should have in the last five years i.e. from 1 st June 2012 onwards.
4.5 A(a)	Minimum annual financial turn over amount is: INR 2 Cr.
9.1	Email id: smarkalyandevcorp@gmail.com Address: As mentioned in Tender Notice
4.5(a)	Address of the Employer: As mentioned in Tender Notice
20.1 (A)	The bid should be uploaded by lated: As mentioned in Tender Notice
	The bid will be opened at: As mentioned in Tender Notice
34.1	The Bank Draft in favour of SmatKalyanDombivli Corporation Limited payable at Kalyan
36.1	The name of Dispute Review Expert is CEO, Smart KalyanDombivli Corporation Limited

SECTION 2
QUALIFICATION INFORMATION

QUALIFICATION INFORMATION

The information to be filled in by the Bidder in the following pages will be used for purposes of post qualification as provided for in Clause 4 of the Instructions to Bidders. This information will not be incorporated in the Contract.

1. For Individual Bidders

1.1 Constitution or Legal status of Bidder (Attach copy)

Place of registration: _____

1.1.1 Principal place of business: _____

1.1.2 Power of attorney of signatory of Bid (Attach)

1.2 Total value of Civil Engineering construction work performed in the last five years (Attach certificates from chartered accountant)

1.2.1 2011-12 _____

1.2.2 2012-13 _____

1.2.3 2013-14 _____

1.2.4 2014-15 _____

1.2.5 2015-16 _____

1.3

1.3.1 Work performed as prime contractor, work performed in the past as a nominated subcontractor will also be considered provided the sub-contract involved execution of all main items of work described in the bid document, provided further that all other qualification criteria are satisfied (in the same name) on works of a similar nature over the last five years.

Project Name	Name of the employer	Description of work	Contact No	Value of contract (Rs crore)	Date of issue of work order	Stipulated period of completion	Actual date of completion	Remarks explaining reasons for delay and work completed

The contractor shall attach the completion certificates, or related certificate from the engineer in charge

- 1.4 Financial reports for the last five years: balance sheets, profit and loss statements, auditors' reports (in case of companies/corporation), etc. List them below and attach copies.
- 1.5 Evidence of access to financial resources to meet the qualification requirements: cash in hand, lines of credit. etc. List them below and attach copies of support documents.
- 1.6 Name, address, and telephone, telex, and fax numbers of the Bidders' bankers who may provide references if contacted by the Employer.
- 1.7 Information on litigation history in which the Bidder is involved.

Other party(ies)	Employer	Case of disputes	Amount involved	Remarks showing present status

- 1.8 Statement of compliance under the requirements of Sub Clause 3.2 of the instructions to Bidders. (Name of Consultant engaged for project preparation is _____ [Name of Consultant])
- 1.9 Proposed work method and schedule. The Bidder should attach descriptions, drawings and charts as necessary to comply with the requirements of the Bidding documents. [Refer ITB Clause 4.1 & 4.3 (1)].
- 1.10 Programme
- 1.11 Quality Assurance Programme
- 1.12 Bidders should provide any additional information required to fulfill the requirements of clause 4 of the Instructions to the Bidders
 - 1.12.1 Affidavit
 - 1.12.2 Undertaking

AFFIDAVIT

I, the undersigned, do hereby certify that all the statements made in the required attachments are true and correct.

The undersigned also hereby certifies that neither our firm M/s _____ have abandoned any work on National Highways in India nor any contract awarded to us for such works have been rescinded, during last five years prior to the date of this bid.

The undersigned hereby authorise(s) and request(s) any bank, person, firm or corporation to furnish pertinent information deemed necessary and requested by the Department to verify this statement or regarding my (our) competence and general reputation.

The undersigned understand and agrees that further qualifying information may be requested, and agrees to furnish any such information at the request of the Department/Project implementing agency.

(Signed by an Authorised Officer of the Firm)

Title of Officer

Name of the firm

Date

UNDERTAKING

I, the undersigned do hereby undertake that our firm M/s _____ would invest a minimum cash up to 25% of the value of the work during implementation of the Contract.

(Signed by an Authorised Officer of the Firm)

Title of Officer

Name of the firm

Date

SECTION 3
CONDITIONS OF CONTRACT

CONDITIONS OF CONTRACT

GENERAL

1. Definitions

1.1. Terms which are defined in the Contract Data are not also defined in the Conditions of Contract but keep their defined meanings. Capital initials are used to identify defined terms.

- a) The Adjudicator (synonymous with Dispute Review Expert) is the person appointed jointly by the Employer and the Contractor to resolve disputes in the first instance, as provided for in Clauses 24 and 25. The name of the Adjudicator is defined in the Contract Data.
- b) Bill of Quantities means the priced and completed Bill of Quantities forming part of the Bid.
- c) Compensation Events are those defined in Clause 44 hereunder.
- d) The Completion Date is the date of completion of the Works as certified by the Engineer in accordance with Sub Clause 55.1.
- e) The Contract is the contract between the Employer and the Contractor to execute, complete and maintain the Works. It consists of the documents listed in Clause 2.3 below.
- f) The Contract Data defines the documents and other information which comprise the Contract.
- g) The Contractor is a person or corporate body whose Bid to carry out the Works has been accepted by the Employer.
- h) The Contractor's Bid is the completed Bidding document submitted by the Contractor to the Employer and includes Technical and Financial bids.
- i) The Contract Price is the price stated in the Letter of Acceptance and thereafter as adjusted in accordance with the provisions of the Contract.
- j) Days are calendar days; months are calendar months.
- k) A Defect is any part of the Works not completed in accordance with the Contract. The Defects Liability Period is the period named in the Contract Data and calculated from the Completion Date.
- l) The Employer is the party who will employ the Contractor to carry out the Works.
- m) The Engineer is the person named in the Contract Data (or any other competent person appointed and notified to the contractor to act in replacement of the Engineer) who is responsible for supervising the Contractor, administering the Contract, certifying payments due to the Contractor, issuing and valuing Variations to the Contract, recommending extensions of time, and valuing the Compensation Events.

- n) Equipment is the Contractor's machinery and vehicles brought temporarily to the Site to construct the Works.
- o) The Initial Contract Price is the Contract Price listed in the Employer's Letter of Acceptance.
- p) The Intended Completion Date is the date on which it is intended that the Contractor shall complete the Works. The Intended Completion Date is specified in the Contract Data. The Intended Completion Date may be revised only by the Engineer incharge after getting approval from competent authority.
- q) Materials are all supplies, including consumables, used by the contractor for incorporation in the Works.
- r) Plant is any integral part of the Works which is to have a mechanical, electrical, electronic or chemical or biological function.
- s) The Site is the area defined as such in the Contract Data.
- t) Site Investigation Reports are those which were included in the Bidding documents and are factual interpretative reports about the surface and sub-surface conditions at the site.
- u) Specification means the Specification of the Works included in the Contract and any modification or addition made or approved by the Engineer.
- v) The Start Date is given in the Contract Data. It is the date when the Contractor shall commence execution of the works. It does not necessarily coincide with any of the Site Possession Dates.
- w) A Subcontractor is a person or corporate body who has a Contract with the Contractor to carry out a part of the work in the Contract which includes work on the Site.
- x) Temporary Works are works designed, constructed, installed, and removed by the Contractor which are needed for construction or installation of the Works.
- y) A Variation is an instruction given by the Engineer, which varies the Works.
- z) The Works are what the Contract requires the Contractor to construct, install, and turn over to the Employer, as defined in the Contract Data.

2. Interpretation

2.1. In interpreting these Conditions of Contract, singular also means plural, male also means female or neuter, and the other way around. Headings have no significance. Words have their normal meaning under the language of the Contract unless specifically defined. The Engineer will provide instructions clarifying queries about the Conditions of Contract.

2.2. If sectional completion is specified in the Contract Data, references in the Conditions of Contract to the Works, the Completion Date, and the Intended Completion Date apply to any Section of the Works (other than references to the Completion Date and Intended Completion date for the whole of the Works).

2.3. The documents forming the Contract shall be interpreted in the following order of priority:

- (1) Agreement
- (2) Letter of Acceptance, notice to proceed with the works
- (3) Contractor's Bid
- (4) Contract Data
- (5) Conditions of Contract including Special Conditions of Contract
- (6) Specifications
- (7) Drawings
- (8) Bill of quantities and
- (9) any other document listed in the Contract Data as forming part of the Contract.

3. Language and Law

3.1. The language of the Contract and the law governing the Contract are stated in the Contract Data.

4. Engineer's Decisions

4.1. Except where otherwise specifically stated, the Engineer will decide contractual matters between the Employer and the Contractor in the role representing the Employer.

5. Delegation

5.1. The Engineer may delegate any of his duties and responsibilities to other people except to the Adjudicator after notifying the Contractor and may cancel any delegation after notifying the Contractor.

6. Communications

6.1. Communications between parties which are referred to in the conditions are effective only when in writing. A notice shall be effective only when it is delivered (interms of Indian Contract Act).

7. Sub-contracting

7.1. The Contractor shall not be allowed to sub-contract any of the services.

8. Other Contractors

8.1. The Contractor shall cooperate and share the Site with other contractors, public authorities, utilities, and the Employer between the dates given in the Schedule of other Contractors. The Contractor shall as referred to in the Contract Data, also provide facilities and services for them as described in the Schedule. The employer may modify the schedule of other contractors and shall notify the contractor of any such modification.

9. Delete

10. Employer's and Contractor's Risks

10.1. The Employer carries the risks which this Contract states are Employer's risks, and the Contractor carries the risks which this Contract states are Contractor's risks.

11. Employer's Risks

11.1. The Employer is responsible for the excepted risks which are (a) in so far as they directly affect the execution of the Works in India, the risks of war, hostilities, invasion, act of foreign enemies, rebellion, revolution, insurrection or military or usurped power, civil war, not commotion or disorder (unless restricted to the Contractor's employees), and contamination from any nuclear fuel or nuclear waste or radioactive toxic explosive, or (b) a cause due solely to the design of the Works, other than the Contractor's design.

12. Contractor's Risks

12.1. All risks of loss of or damage to physical property and of personal injury and death which arise during and in consequence of the performance of the Contract other than the excepted risks are the responsibility of the Contractor.

13. Insurance

13.1. The Contractor shall provide, in the joint names of the Employer and the Contractor, insurance cover from the Start Date to the end of the Defects Liability Period, in the amounts and deductibles stated in the Contract Data for the following events which are due to the Contractor's risks:

- (a) Loss of or damage to the Works, Plant and Materials;
- (b) Loss of or damage to Equipment;
- (c) Loss of or damage of property (except the Works, Plant, Materials and Equipment) in connection with the Contract; and
- (d) Personal injury or death.

13.2. Policies and certificates for insurance shall be delivered by the Contractor to the Engineer for the Engineer's approval before the Start Date. All such insurance shall provide for compensation to be payable in the types and proportions of currencies required to rectify the loss or damage incurred.

13.3. If the Contractor does not provide any of the policies and certificates required, the Employer may Effect the insurance which the Contractor should have provided and recover the premiums the Employer has paid from payments otherwise due to the Contractor or, if no payment is due, the payment of the premiums shall be a debt due.

13.4. Alterations to the terms of an insurance shall not be made without the approval of the Engineer.

13.5. Both parties shall comply with any conditions of the insurance policies.

14. Site Investigation Reports

14.1. The Contractor, in preparing the Bid, shall rely on any site Investigation Reports referred to in the Contract Data, supplemented by any information available to the Bidder.

15. Queries about the Contract Data

15.1. The Engineer will clarify queries on the Contract Data.

16. Contractor to Construct the Works

16.1. The Contractor shall construct and install the Works in accordance with the Specification and Drawings.

17. The Works to be completed by the Intended Completion Date

17.1. The Contractor may commence execution of the Works on the Start Date and shall carry out the Works in accordance with the programme submitted by the Contractor, as updated with the approval of the Engineer, and complete them by the Intended Completion Date.

18. Approval by the Engineer

18.1. The Contractor shall submit Specifications and Drawings showing the proposed Temporary Works to the Engineer, who is to approve them if they comply with the Specifications and Drawings.

18.2. The Contractor shall be responsible for design of Temporary Works.

18.3. The Engineer's approval shall not alter the Contractor's responsibility for design of the Temporary Works.

18.4. The Contractor shall obtain approval of third parties to the design of the Temporary Works where required.

18.5. All Drawings prepared by the Contractor for the execution of the temporary or permanent Works, are subject to prior approval by the Engineer before their use.

19. Safety

19.1. The Contractor shall be responsible for the safety of all activities on the Site.

20. Discoveries

20.1. Anything of historical or other interest or of significant value unexpectedly discovered on the Site is the property of the Employer. The Contractor is to notify the Engineer of such discoveries and carry out the Engineer's instructions for dealing with them.

21. Possession of the Site

21.1. The Employer shall give possession of all parts of the Site to the Contractor. If possession of a part is not given by the date stated in the Contract Data the Employer is deemed to have delayed the start of the relevant activities and this will be Compensation Event.

22. Access to the Site

22.1. The Contractor shall allow the Engineer and any person authorized by the Engineer access to the Site, to any place where work in connection with the Contract is being carried out or is intended to be carried out and to any place where materials or plant are being manufactured / fabricated / assembled for the works.

23. Instructions

23.1. The Contractor shall carry out all instructions of the Engineer pertaining to works which comply with the applicable laws where the Site is located.

23.2. The Contractor shall permit the Employer to inspect the Contractor's accounts and records relating to the performance of the Contractor and to have them audited by auditors appointed by the Employer, if so required by the Employer.

24. Disputes

24.1. If the Contractor believes that a decision taken by the Engineer was either outside the authority given to the Engineer by the Contract or that the decision was wrongly taken, the decision shall be referred to the Dispute Review Expert within 14 days of the notification of the Engineer's decision.

25. Procedure for Disputes

25.1. The Dispute Review Expert shall give a decision in writing within 28 days of receipt of a notification of a dispute.

25.2. The Dispute Review Expert shall be paid daily at the rate specified in the Contract Data together with reimbursable expenses of the types specified in the Contract

Whatever decision is reached by the Dispute Review Expert. Either party may give notice to the other to refer a decision of the Dispute Review Expert to an Arbitrator within 28 days of the Dispute Review Expert's written decision. If neither party refers the dispute to arbitration within the next 28 days, the Dispute Review Expert's decision will be final and binding.

25.3. The arbitration shall be conducted in accordance with the arbitration procedure stated in the Special Conditions of Contract.

26. Replacement of Dispute Review Expert

26.1. Should the Dispute Review Expert resign or die, or should the Employer and the Contractor agree that the Dispute Review Expert is not fulfilling his functions in accordance with the provisions of the Contract, a new Dispute Review Expert will be jointly appointed by the Employer and the Contractor. In case of disagreement between the Employer and the Contractor, within 30 days, the Dispute Review Expert shall be designated by the Appointing Authority designated in the Contract Data at the request of either party, within 14 days of receipt of such request.

B. TIME CONTROL

27. Programme

27.1. Within the time stated in the Contract Data the Contractor shall submit to the Engineer for approval a Programme showing the general methods, arrangements, order, and timing for all the activities in the Works along with monthly cash flow forecast.

27.2. An update of the Programme shall be a programme showing the actual progress achieved on each activity and the effect of the progress achieved on the timing of the remaining work including any changes to the sequence of the activities.

27.3. The Contractor shall submit to the Engineer, for approval, an updated Programme at intervals no longer than the period stated in the Contract Data. If the Contractor does not submit an updated Programme within this period, the Engineer may withhold the amount stated in the Contract Data from the next payment certificate and continue to withhold this amount until the next payment after the date on which the overdue Programme has been submitted.

27.4. The Engineer's approval of the Programme shall not alter the Contractor's obligations. The Contractor may revise the Programme and submit it to the Engineer again at any time. A revised Programme is to show the effect of Variations and Compensation Events.

28. Extension of the Intended Completion Date

28.1. The Engineer shall extend the Intended Completion Date if a Compensation Event occurs or a Variation is issued which makes it impossible for Completion to be achieved by the Intended Completion Date without the Contractor taking steps to accelerate the remaining work and which would cause the Contractor to incur additional cost.

28.2. The Engineer shall decide whether and by how much to extend the Intended Completion Date within 35 days of the Contractor asking the Engineer for a decision upon the effect of a Compensation Event or Variation and submitting full supporting information. If the Contractor has failed to give early warning of a delay or has failed to cooperate in dealing with a delay, the delay by this failure shall not be considered in assessing the new Intended Completion Date.

28.3. The Engineer shall within 14 days of receiving full justification from the contractor for extension of Intended Completion Date refer to the Employer his decision.

The Employer shall in not more than 21 days communicate to the Engineer the acceptance or otherwise of the Engineer's decision. If the Employer fails to give his acceptance, the Engineer shall not grant the extension and the contractor may refer the matter to the Dispute Review Expert under Clause 24.1.

29. Deleted

30. Delays Ordered by the Engineer

30.1. The Engineer may instruct the Contractor to delay the start or progress of any activity within the Works.

31. Management Meetings

31.1. Either the Engineer or the Contractor may require the other to attend a management meeting. The business of a management meeting shall be to review the plans for remaining work and to deal with matters raised in accordance with the early warning procedure.

31.2. The Engineer shall record the business of management meetings and is to provide copies of his record to those attending the meeting and to the Employer. The responsibility of the parties for actions to be taken is to be decided by the Engineer either at the management meeting or after the management meeting and stated in writing to all who attended the meeting.

32. Early Warning

32.1. The Contractor is to warn the Engineer at the earliest opportunity of specific likely future events or circumstances that may adversely affect the quality of the work, increase the Contract Price or delay the execution of works. The Engineer may require the Contractor to provide an estimate of the expected effect of the future event or circumstance on the Contract Price and Completion Date. The estimate is to be provided by the Contractor as soon as reasonably possible.

32.2. The Contractor shall cooperate with the Engineer in making and considering proposals for how the effect of such an event or circumstance can be avoided or reduced by anyone involved in the work and in carrying out any resulting instruction of the Engineer.

C. QUALITY CONTROL

33. Identifying Defects

33.1. The Engineer shall check the Contractor's work and notify the Contractor of any Defects that are found. Such checking shall not affect the Contractor's responsibilities. The Engineer may instruct the Contractor to search for a Defect and to uncover and test any work that the Engineer considers may have a Defect

34. Tests

34.1. If the Engineer instructs the Contractor to carry out a test not specified in the Specification to check whether any work has a Defect and the test shows that it does, the Contractor shall pay for the test and any samples. If there is no Defect the test shall be a Compensation Event.

35. Correction of Defects

35.1. The Engineer shall give notice to the Contractor of any Defects before the end of the Defects Liability Period, which begins at Completion and is defined in the Contract Data. The Defects Liability Period shall be extended for as long as Defects remain to be corrected.

35.2. Every time notice of a Defect is given, the Contractor shall correct the notified Defect within the length of time specified by the Engineer's notice.

36. Uncorrected Defects

36.1. If the Contractor has not corrected a Defect within the time specified in the Engineer's notice, the Engineer will assess the cost of having the Defect corrected, and the Contractor will pay this amount.

D. COST CONTROL

37. Bill of Quantities

37.1. The Bill of Quantities shall contain items for the construction, installation, testing, and commissioning work to be done by the Contractor.

37.2. The Bill of Quantities is used to calculate the Contract Price. The Contractor is paid for the quantity of the work done at the rate in the Bill of Quantities for each item.

38. Changes in the Quantities

38.1. If the final quantity of the work done differs from the quantity in the Bill of Quantities for the particular item by more than 25 per cent provided the change exceeds 1% of initial Contract Price, the Engineer shall adjust the rate to allow for the change, duly considering,

- (a) justification for rate adjustment as furnished by the contractor,
- (b) economies resulting from increase in quantities by way of reduced plant, equipment, and overhead costs,
- (c) entitlement of the contractor to compensation events where such events are caused by any additional work

38.2. The Engineer shall not adjust rates from changes in quantities if thereby the Initial Contract Price is exceeded by more than 15 per cent, except with the Prior approval of the Employer.

38.3. If requested by the Engineer, the Contractor shall provide the Engineer with a detailed cost breakdown of any rate in the Bill of Quantities.

39. Delete

40. Delete

41. Cash Flow Forecasts

41.1. When the Programme is updated, the contractor is to provide the Engineer with an updated cash flow forecast.

42. Payment Certificates

42.1. The Contractor shall submit to the Engineer monthly statements of the estimated value of the work completed less the cumulative amount certified previously.

42.2. The Engineer shall check the Contractor's monthly statement within 14 days and certify the amount to be paid to the Contractor after taking into account any credit or debit for the month in question in respect of materials for the works in the relevant amounts and under conditions set forth in sub-clause 51(3) of the Contract Data (Secured Advance).

42.3. The value of work executed shall be determined by the Engineer.

42.4. The value of work executed shall comprise the value of the quantities of the items in the Bill of Quantities completed.

42.5. The value of work executed shall include the valuation of Variations and Compensation Events.

42.6. The Engineer may exclude any item certified in a previous certificate or reduce the proportion of any item previously certified in any certificate in the light of later information.

43. Payments

43.1. Payments shall be adjusted for deductions for advance payments, retention, other recoveries in terms of the contract and taxes at source, as applicable under the law. The Employer shall pay the Contractor the amounts certified by the Engineer within 28 days of the date of each certificate. If the Employer makes a late payment, the Contractor shall be paid interest on the late payment in the next payment. Interest shall be calculated from the date by which the payment should have been made upto the date when the late payment is made at 12% per annum.

43.2. If an amount certified is increased in a later certificate as a result of an award by the Adjudicator or an Arbitrator, the Contractor shall be paid interest upon the delayed payment as set out in this clause. Interest shall be calculated from the date upon which the increased amount would have been certified in the absence of dispute.

43.3. Items of the Works for which no rate or price has been entered in will not be paid for by the Employer and shall be deemed covered by other rates and prices in the Contract.

44. Compensation Events

44.1. The following are Compensation Events unless they are caused by the Contractor.

(a) The Employer does not give access to a part of the Site by the Site Possession Date stated in the Contract Data.

(b) The Employer modifies the schedule of other contractors in a way which affects the work of the contractor under the contract.

(c) The Engineer orders a delay or does not issue drawings, specifications or instructions required for execution of works on time.

(d) The Engineer instructs the Contractor to uncover or to carry out additional tests upon work which is then found to have no Defects.

{f} Ground conditions are substantially more adverse than could reasonably have been assumed before issuance of Letter of Acceptance from the information issued to Bidders (including the Site Investigation Reports), from information available publicly and from a visual inspection of the site.

(g) The Engineer gives an instruction for dealing with an unforeseen condition, caused by the Employer, or additional work required for safety or other reasons.

(h) Other contractors, public authorities, utilities or the Employer does not work within the dates and other constraints stated in the Contract, and they cause delay or extra cost to the Contractor.

(j) The effect on the Contractor of any of the Employer's Risks.

(l) Other Compensation Events listed in the Contract Data or mentioned in the Contract.

44.2. If a Compensation Event would cause additional cost or would prevent the work being completed before the Intended Completion Date, the Contract Price shall be increased and/or the Intended Completion Date is extended. The Engineer shall decide whether and by how much the Contract Price shall be increased and whether and by how much the Intended Completion Date shall be extended.

44.3. As soon as information demonstrating the effect of each Compensation Event upon the Contractor's forecast; cost has been provided by the Contractor, it is to be assessed by the Engineer and the Contract Price shall be adjusted accordingly. If the Contractor's forecast is deemed unreasonable, the Engineer shall adjust the Contract Price based on Engineer's own forecast. The Engineer will assume that the Contractor will react competently and promptly to the event.

44.4. The Contractor shall not be entitled to compensation to the extent that the Employer's interests are adversely affected by the Contractor not having given early warning or not having cooperated with the Engineer.

45. Tax

45.1. The rates quoted by the Contractor shall be deemed to be inclusive of the sales and other taxes that the Contractor will have to pay for the performance of this Contract. The Employer will perform such duties in regard to the deduction of such taxes at source as per applicable law.

46. Currencies

46.1. All payments shall be made in Indian Rupees.

47. Delete

48. Retention

48.1. The Employer shall retain from each payment due to the Contractor the proportion stated in the Contract Data until Completion of the whole of the Works.

48.2. On Completion of the whole of the Works half the total amount retained is repaid to the Contractor and half when the Defects Liability Period has passed and the Engineer has certified that all Defects notified by the Engineer to the Contractor before the end of this period have been corrected.

48.3. On completion of the whole works, the contractor may substitute retention money with an "on demand" Bank guarantee.

49. Liquidated Damages

49.1. The Contractor shall pay liquidated damages to the Employer at the rate per day stated in the Contract Data for each day that the Completion Date is later than the Intended Completion Date (for the whole of the works or the milestone as stated in the contract data). The total amount of liquidated damages shall not exceed the amount defined in the Contract

Data. The Employer may deduct liquidated damages from payments due to the Contractor. Payment of liquidated damages does not affect the Contractor's liabilities.

49.2. If the Intended Completion Date is extended after liquidated damages have been paid, the Engineer shall correct any overpayment of liquidated damages by the Contractor by adjusting the next payment certificate. The Contractor shall be paid interest on the over payment calculated from the date of payment to the date of repayment at the rates specified in Sub Clause 43.1.

49.3. If the contractor fails to comply with the time for completion as stipulated in the tender, then the contractor shall pay to the employer the relevant sum stated in the Contract Data as Liquidated damages for such default and not as penalty for everyday or part of day which shall elapse between relevant time for completion and the date stated in the taking over certificate of the whole of the works on the relevant section, subject to the limit stated in the contract data.

The employer may, without prejudice to any other method of recovery deduct the amount of such damages from any monies due or to become due to the contractor. The payment or deduction of such damages shall not relieve the contractor from his obligation to complete the works on from any other of his obligations and liabilities under the contract.

49.4. If, before the Time for Completion of the whole of the Works or, if applicable, any Section, a Taking Over Certificate has been issued for any part of the Works or of a Section, the liquidated damages for delay in completion of the remainder of the Works or of that Section shall, for any period of delay after the date stated in such Taking-Over Certificate, and in the absence of alternative provisions in the Contract, be reduced in the proportion which the value of the part so certified bears to the value of the whole of the Works or Section, as applicable. The provisions of this Sub-Clause shall only apply to the rate of liquidated damages and shall not affect the limit thereof.

50. Delete

51. delete

52. Securities

52.1. The Performance Security (including additional security for unbalanced bids) shall be provided to the Employer no later than the date specified in the Letter of Acceptance and shall be issued in an amount and form and by a bank or surety acceptable to the Employer, and denominated in Indian Rupees. The Performance Security shall be valid until a date 28 days from the date of expiry of Defects Liability Period and the additional security for unbalanced bids shall be valid until a date 28 days from the date of issue of the certificate of completion.

53. Deleted

54. Cost of Repairs

54.1. Loss or damage to the Works or Materials to be incorporated in the Works between the Start Date and the end of the Defects Correction periods shall be remedied by the Contractor at the Contractor's cost if the loss or damage arises from the Contractor's acts or omissions.

E. FINISHING THE CONTRACT

55. Completion

55.1. The Contractor shall request the Engineer to issue a Certificate of Completion of the Works and the Engineer will do so upon deciding that the Work is completed.

56. Taking Over

56.1. The Employer shall take over the Site and the Works within seven days of the Engineer issuing a certificate of Completion.

57. Final Account

57.1. The Contractor shall supply to the Engineer a detailed account of the total amount that the Contractor considers payable under the Contract before the end of the Defects Liability Period. The Engineer shall issue a Defect Liability Certificate and certify any final payment that is due to the Contractor within 56 days of receiving the Contractor's account if it is correct and complete. If it is not, the Engineer shall issue within 56 days a schedule that states the scope of the corrections or additions that are necessary. If the Final Account is still unsatisfactory after it has been resubmitted, the Engineer shall decide on the amount payable to the Contractor and issue a payment certificate, within 56 days of receiving the Contractor's revised account.

58. Operating and Maintenance Manuals

58.1. If "as built" Drawings and/or operating and maintenance manuals are required, the Contractor shall supply them by the dates stated in the Contract Data.

58.2. If the Contractor does not supply the Drawings and/or manuals by the dates stated in the Contract Data, or they do not receive the Engineer's approval, the Engineer shall withhold the amount stated in the Contract Data from payments due to the Contractor.

59. Termination

59.1. The Employer or the Contractor may terminate the Contract if the other party causes a fundamental breach of the Contract.

59.2. Fundamental breaches of Contract include, but shall not be limited to the following:

- (a) the Contractor stops work for 28 days when no stoppage of work is shown on the current Programme and the stoppage has not been authorized by the Engineer;
- (b) the Engineer instructs the Contractor to delay the progress of the Works and the instruction is not withdrawn within 28 days;
- (c) the Employer or the Contractor is made bankrupt or goes into liquidation other than for a reconstruction or amalgamation;

- (d) a payment certified by the Engineer is not paid by the Employer to the Contractor within 56 days of the date of the Engineer's certificate;
- (e) the Engineer gives Notice that failure to correct a particular Defect is a fundamental breach of Contract and the Contractor fails to correct it within a reasonable period of time determined by the Engineer;
- (f) the Contractor does not maintain a security which is required;
- (g) the Contractor has delayed the completion of works by the number of days for which the maximum amount of liquidated damages can be paid as defined in the Contract data; and
- (h) if the Contractor, in the judgment of the Employer has engaged in corrupt or fraudulent practices in competing for or in executing the Contract.

For the purpose of this paragraph : "corrupt practice" means the offering, giving, receiving or soliciting of anything of value to influence the action of a public official in the procurement process or in contract execution. "Fraudulent practice" means a misrepresentation of facts in order to influence a procurement process or the execution of a contract to the detriment of the Borrower, and includes collusive practice among Bidders (prior to or after bid submission) designed to establish bid prices at artificial non-competitive levels and to deprive the Borrower of the benefits of free and open competition."

59.3. When either party to the Contract gives notice of a breach of contract to the Engineer for a cause other than those listed under Sub Clause 59.2 above, the Engineer shall decide whether the breach is fundamental or not.

59.4. Notwithstanding the above, the Employer may terminate the Contract for convenience.

59.5. If the Contract is terminated the Contractor shall stop work immediately, make the Site safe and secure and leave the Site as soon as reasonably possible.

60. Payment upon Termination

60.1. If the-Contract is terminated because of a fundamental breach of Contract by the Contractor, the Engineer shall issue a certificate for the value of the work done less advance payments received up to the date of the issue of the certificate, less other recoveries due in terms of the contract, less taxes due to be deducted at source as per applicable law and less the percentage to apply to the work not completed as indicated in the Contract Data. Additional Liquidated Damages shall not apply. If the total amount due to the Employer exceeds any payment due to the Contractor the difference shall be a debt payable to the Employer.

60.2. If the Contract is terminated at the Employer's convenience or because of a fundamental breach of Contract by the Employer, the Engineer shall issue a certificate for the value of the work done, the cost of balance material brought by the contractor and available at site, the reasonable cost of removal of Equipment, repatriation of the Contractor's personnel employed solely on the Works, and the Contractor's costs of protecting and securing the Works and less advance

payments received up to the date of the certificate, less other recoveries due in terms of the contract and less taxes due to be deducted at source as per applicable law.

61. Property

61.1. All materials on the Site, Plant, Equipment, Temporary Works and Works are deemed to be the property of the Employer, if the Contract is terminated because of a Contractor's default.

62. Release from Performance

62.1. If the Contract is frustrated by the outbreak of war or by any other event entirely outside the control of either the Employer or the Contractor the Engineer shall certify that the Contract has been frustrated. The Contractor shall make the Site safe and stop work as quickly as possible after receiving this certificate and shall be paid for all work carried out before receiving it and for any work carried out afterwards to which commitment was made.

SECTION VIII: SPECIAL CONDITIONS OF CONTRACT

1. LABOUR:

The Contractor shall, unless otherwise provided in the Contract, make his own arrangements for the engagement of all staff and labour, local or other, and for their payment, housing, feeding and transport. The Contractor shall, if required by the Engineer, deliver to the Engineer a return in detail, in such form and at such intervals as the Engineer may prescribe, showing the staff and the numbers of the several classes of labour from time to time employed by the Contractor on the Site and such other information as the Engineer may require.

2. COMPLIANCE WITH LABOUR REGULATIONS:

During continuance of the contract, the Contractor and his sub-contractors shall abide at all times by all existing labour enactments and rules made thereunder, regulations, notifications and bye laws of the State or Central Government or local authority and any other labour law (including rules), regulations, bye laws that may be passed or notification that may be issued under any labour law in future either by the State or the Central Government or the local authority. Salient features of some of the major labour laws that are applicable to construction industry are given below. The Contractor shall keep the Employer indemnified in case any action is taken against the Employer by the competent authority on account of contravention of any of the provisions of any Act or rules made thereunder, regulations or notifications including amendments. If the Employer is caused to pay or reimburse, such amounts as may be necessary to cause or observe, or for non-observance of the provisions stipulated in the notifications/bye laws/Acts/Rules/regulations including amendments, if any, on the part of the Contractor, the Engineer/Employer shall have the right to deduct any money due to the Contractor including his amount of performance security. The Employer/Engineer shall also have right to recover from the Contractor any sum required or estimated to be required for making good the loss or damage suffered by the Employer.

The employees of the Contractor and the Sub-Contractor in no case shall be treated as the employees of the Employer at any point of time.

3. SALIENT FEATURES OF SOME MAJOR LABOUR LAWS APPLICABLE TO ESTABLISHMENTS ENGAGED IN BUILDING AND OTHER CONSTRUCTION WORK.

a) Workmen Compensation Act 192 :- The Act provides for compensation in case of injury by accident arising out of and during the course of employment.

b) Payment of Gratuity Act 1972 :- Gratuity is payable to an employee under the Act on satisfaction of certain conditions on separation if an employee has completed 5 years' service or more on death, the rate of 15 days wages for every completed year of service. The Act is applicable to all establishments employing 10 or more employees.

c) Employees P.F. and Miscellaneous Provision Act 1952: The Act Provides for monthly contributions by the employer plus workers @ 10% or 8.33%. The benefits payable under the Act are :

(i) Pension or family pension on retirement or death, as the case may be.

(ii) Deposit linked insurance on the death in harness of the worker.

(iii) Payment of P.F. accumulation on retirement/death etc.

d) Maternity Benefit Act 1951 :- The Act provides for leave and some other benefits to women employees in case of confinement or miscarriage etc.

e) Contract Labour (Regulation Abolition) Act 1970 :- The Act provides for certain welfare measures to be provided by the Contractor to contract labour and in case the Contractor fails to provide, the same are required to be provided, by the Principal Employer by Law. The Principal Employer is required to take Certificate of Registration and the Contractor is required to take licence from the designated Officer. The Act is applicable to the establishments or Contractor of Principal Employer, if they employ 20 or more contract labour.

f) Minimum Wages Act 1948 :- The Employer is supposed to pay not less than the Minimum Wages fixed by appropriate Government as per provisions of the Act, if the employment is a scheduled employment. Construction of Buildings, Roads, Runways are scheduled employments.

g) Payment of Wages Act 1936 :- It lays down as to by what date the wages are to be paid, when it will be paid and what deductions can be made from the wages of the workers.

h) Equal Remuneration Act 1979 The Act provides for payment of equal wages for work of equal nature to Male and Female workers and for not making discrimination against Female employees in the matters of transfers, training and promotions etc.

Payment of Bonus Act 1965:- The Act is applicable to all establishments employing 20 or more employees. The Act provides for payments of annual bonus subject to a minimum of 8.33% of wages and maximum of 20% of wages to employees drawing Rs.3500/-per month or less. The bonus to be paid to employees getting Rs.25001- per month or above upto Rs.3500/- per month shall be worked out by taking wages as Rs.2500/

-per month only. The Act does not apply to certain establishments. The newly set-up establishments are exempted for five years in certain circumstances. Some of the State Governments have reduced the employment size from 20 to 10 for the purpose of applicability of this Act.

j) Industrial Disputes Act 1947 :- The Act lays down the machinery and procedure for resolution of Industrial disputes, in what situations a strike or lock-out becomes illegal and what are the requirements for laying off or retrenching the employees or closing down the establishment.

k) Industrial Employment (Standing Orders) Act 1946 :- It is applicable to all establishments employing 100 or more workmen (employment size reduced by some of the States and Central Government to 50). The Act provides for laying down rules governing the conditions of employment by the Employer on matters provided in the Act and get the same certified by the designated Authority.

l) Trade Unions Act 1926 :- The Act lays down the procedure for registration of trade unions of workmen and employers. The Trade Unions registered under the Act have been given certain immunities from civil and criminal liabilities.

m) Child Labour (Prohibition & Regulation) Act 1986:- The Act prohibits employment of children below 14 years of age in certain occupations and processes and provides for regulation of employment of children in all other occupations and processes. Employment of Child Labour is prohibited in Building and Construction Industry.

n) Inter-State Migrant workmen's (Regulation of Employment & Conditions of Service) Act 1979 :- The Act is applicable to an establishment which employs 5 or more inter-state migrant workmen through an intermediary (who has recruited workmen in one state for employment in the establishment situated in another state). The Inter-State migrant workmen, in an establishment to which this Act becomes applicable, are required to be provided certain facilities such as housing, medical aid, travelling expenses from home upto the establishment and back, etc.

o) The Building and Other Construction workers (Regulation of Employment and Conditions of Service) Act 1996 and the Cess Act of 1996 :- All the establishments who carry on any building or other construction work and employs 10 or more workers are covered under this Act. All such establishments are required to pay cess at the rate not exceeding 2% of the cost of construction as may be modified by the Government. The Employer of the establishment is required to provide safety measures at the Building or construction work and other welfare measures, such as Canteens, First-Aid facilities, Ambulance, Housing accommodations for workers near the work place etc. The Employer to whom the Act applies has to obtain a registration certificate from the Registering Officer appointed by the Government.

p) Factories Act 1948 :- The Act lays down the procedure for approval of plans before setting up a factory, health and safety provisions, welfare provisions, working hours,

annual earned leave and rendering information regarding accidents or dangerous occurrences to designated authorities. It is applicable to premises employing 10 persons or more with aid of power or 20 or more persons without the aid of power engaged in manufacturing process.

4. ARBITRATION (GCC Clause 25.3)

The procedure for arbitration will be as follows:

25.3 (a) In case of Dispute or difference arising between the Employer and a domestic contractor relating to any matter arising out of or connected with this agreement, such disputes or difference shall be settled in accordance with the Arbitration and Conciliation Act, 1996. The parties shall make efforts to agree on a sole arbitrator and only if such an attempt does not succeed and the Arbitral Tribunal consisting of 3 arbitrators one each to be appointed by the Employer and the Contractor and the third Arbitrator to be chosen by the two Arbitrators so appointed by the Parties to act as Presiding Arbitrator shall be considered. In case of failure of the two arbitrators appointed by the parties to reach upon a consensus within a period of 30 days from the appointment of the arbitrator appointed subsequently, the Presiding Arbitrator shall be appointed by the * Council, Indian Roads Congress.

(b) The Arbitral Tribunal shall consist of three Arbitrators one each to be appointed by the Employer and the Contractor. The third Arbitrator shall be chosen by the two Arbitrators so appointed by the Parties, and shall act as a presiding arbitrator. In case of failure of the two arbitrators appointed by the parties to reach upon a consensus within a period of 30 days from the appointment of the arbitrator appointed subsequently, the Presiding arbitrator shall be appointed by the * Council, Indian Roads Congress.

(c) If one of the parties fails to appoint its arbitrator in pursuance of sub-clause (a) and (b) above within 30 days after receipt of the notice of the appointment of its arbitrator by the other party, then the * Council, Indian Roads Congress shall appoint the arbitrator. A certified copy of the order of the Council, Indian Roads Congress, taking such an appointment shall be furnished to each of the parties.

(d) Arbitration proceedings shall be held in India, and the language of the arbitration proceedings and that of all documents and communications between the parties shall be English.

(e) The decision of the majority of arbitrators shall be final and binding upon both parties. The cost and expenses of Arbitration proceedings will be paid as determined by the arbitral tribunal. However, the expenses incurred by each party in connection with the preparation, presentation, etc. of its proceedings as also the fees and expenses paid to the arbitrator appointed by such party or on its behalf shall be borne by each party itself.

(f) Performance under the contract shall continue during the arbitration proceedings and payments due to the contractor by the owners shall not be withheld, unless they are the subject matter of the arbitration proceedings.

CONTRACT DATA

Clause 1.1	1. The Employer is Name: Smart KalyanDombivliDevelopment Corporation Limited Address: Kalyan-Dombivli Municipal Corporation Building, near ShivajiChowk, Kalyan-West, Kalyan														
Clause 1.1	The Engineer is: _____ Name of Authorized Representative: _____														
Clause 1.1	The Dispute Review Expert appointed jointly by the Employer and contractor is: *Name: CEO-SKDCL *Address : Chamber of Commissioner, Kalyan-Dombivli Municipal Corporation building, ShivajiChowk, Kalyna-West														
Clause 1.1 and 35	The Defects Liability Period is 365 days from the date of completion.														
Clause 1.1	The Start Date shall be 7 days for the date of issue of the Notice to proceed with the work.														
Clause 2.2 and 49.1	The Intended Completion Date for the whole of the Works is 18 months months after start of work with the following milestones: <table border="1" style="width: 100%; border-collapse: collapse;"> <thead> <tr> <th style="text-align: left;">Physical works to be completed</th> <th style="text-align: left;">Period from the start date</th> </tr> </thead> <tbody> <tr> <td>Milestone 1: Submission and approval of surveys/investigations /designs and good for construction drawings</td> <td>30 days</td> </tr> <tr> <td>Milestone 2: Completion of 50% of the works</td> <td>130 days</td> </tr> <tr> <td>Milestone 3: Completion of 100% works</td> <td>180 days</td> </tr> <tr> <td>Milestone 4: 1st quarterly report for defects liability period</td> <td>275 days</td> </tr> <tr> <td>Milestone 5: 2nd quarterly report for defects liability period</td> <td>360 days</td> </tr> <tr> <td>Milestone 6: 3rd quarterly report for defects liability period</td> <td>455 days</td> </tr> </tbody> </table>	Physical works to be completed	Period from the start date	Milestone 1: Submission and approval of surveys/investigations /designs and good for construction drawings	30 days	Milestone 2: Completion of 50% of the works	130 days	Milestone 3: Completion of 100% works	180 days	Milestone 4: 1 st quarterly report for defects liability period	275 days	Milestone 5: 2 nd quarterly report for defects liability period	360 days	Milestone 6: 3 rd quarterly report for defects liability period	455 days
Physical works to be completed	Period from the start date														
Milestone 1: Submission and approval of surveys/investigations /designs and good for construction drawings	30 days														
Milestone 2: Completion of 50% of the works	130 days														
Milestone 3: Completion of 100% works	180 days														
Milestone 4: 1 st quarterly report for defects liability period	275 days														
Milestone 5: 2 nd quarterly report for defects liability period	360 days														
Milestone 6: 3 rd quarterly report for defects liability period	455 days														

	Milestone 7: 4 th quarterly report for defects liability period	545 days
Clause 1.1	The Site is located at KalyanMurbad road	
Clause 1.1	The name and identification number of the Contract is: Tender No: _____ Name of the tender As mentioned in Tender notice	
Clause 1.1	The works consist of: Preparation of Good for construction drawings, Laying of footpaths, landscaping and street-scaping works, installation of signage, laying of optical fibres, providing infrastructure for movement of handicapped through the provisions of ramps, tactile blocks, pedestrian refuge islands, all aspects of quality assurance of various components of the works, rectifications of the defects in the completed works during the Defects Liability Period; submission of “As Built” drawings and any other related documents; and other item of work as may be required to be carried out for completing the works in accordance with the drawings and provisions in contract to ensure safety.	
Clause 2.3 (9)	The following documents also form part of the Contract: <ul style="list-style-type: none"> • Contract Data • Scope of work • Technical Specifications • Drawings • Form of Bid • Securities and other forms • Bill of quantity 	
Clause 3.1	The law which applies to the Contract is the law of Union of India	
Clause 3.1	The language of the Contract documents is English	
Clause 7.1	No works shall be sub-contracting	
Clause 13	The minimum insurance cover for physical property, injury and death is Rs.5 lakhs per occurrence with the number of occurrences limited to four. After each occurrence, contractor will pay additional premium necessary to make insurance valid for four occurrences always.	
Clause 14	Site investigation report	
Clause 21	The Site Possession Dates shall be: will inform by officer appointed by authority.	
Clause 26	Appointing Authority for the Dispute Review Expert - Council, Indian Roads Congress, New Delhi.	
Clause 27.1	The period for submission of the program for approval of Engineer	

	shall be 21 days from the issue of Letter of Acceptance.
Clause 27.3	The period between program updates shall be 30 days days.
Clause 27.3	The amount to be withheld for late submission of an updated program shall be 1%
Clause 44	The following events shall also be Compensation Events: <ul style="list-style-type: none"> i. Substantially adverse ground conditions encountered during the course of execution of work not provided for in the bidding document ii. Removal of underground utilities detected subsequently iii. Significant change in classification of soil requiring additional mobilisation by the contractor, e.g. ordinary soil to rock excavation, iv. Removal of unsuitable material like marsh, debris dumps, etc not caused by the contractor v. Artesian condition vi. Seepage, erosion, landslide vii. River training requiring protection of permanent work viii. Presence of historical, archeological or religious structures, monuments interfering with the works ix. Restriction of access to ground imposed by civil, judicial, or military authority
Clause 46	The currency of the Contract is Indian Rupees.
Clause 48	The proportion of payments retained (retention money) shall be 5% from each bill subject to a maximum of 10% of final contract price.
Clause 49	Amount of liquidated damages for delay in completion of works: For Whole- of work (1/2000)th of the Initial Contract Price, rounded off to the nearest Thousand, per day. For sectional completion (wherever specified. in item 6 of Contract Data) (1/200)th of initial contract price for 5 km section, rounded off to the nearest thousand per day.
Clause 49	Maximum limit of liquidated damages for delay in completion of work: 10 per cent of the Initial Contract Price rounded off to the nearest thousand.
Clause 52	The Securities shall be for the following minimum amounts equivalent as a percentage of the Contract Price: Performance Security for 5 per cent of contract price plus Rs. (to be decided after evaluation of the bid) as additional security in terms of ITB Clause 29.5. The standard form of Performance Security acceptable to the Employer shall be an unconditional Bank Guarantee of the type as presented in Section 8 of the Bidding Documents.
Clause 58	The date by which "as-built" drawings (in scale as directed) in 2 sets are required is within 28 days of issue of certificate of completion of whole or section of the work, as the case may be.

Clause 58	The amount to be withheld for failing to supply "as built" drawings by the date required is 2% .of the contract value.
Clause 59.2	The following events shall also be fundamental breach of contract: "The Contractor has contravened Sub-clause 7.1 of GCC."
Clause 60	The percentage to apply to the value of the work not completed representing the Employer's additional cost for completing the Works shall be 20 per cent.

SCOPE OF WORK

Scope of Work

BACKGROUND

Smart Kalyan-Dombivli Development Corporation Limited (SKDCL) has been incorporated on 1st September 2016 to implement the projects / interventions under the smart city proposal of Kalyan-Dombivli city as approved by Ministry of Urban Development, GOI. In line with the Central Government's guidelines, the smart city proposal includes an 'area based development' and 'pan city solution'.

Under the project, development of complete street network for ABD, 83 km of streets were identified by the corporation, which would require retrofitting in terms of provisions for continuous footpaths as per the surrounding land use and the road character, providing universal accessibility, signage, landscaping, and street furniture. The basic objective of the project was to ensure that the implementation of the project will result in the development of pedestrian friendly streets which would be well connected with different land uses and shall have suitable provisions for universal accessibility.

Towards the implementation of the network of complete streets project, development of KalyanMurbad Road as Smart Street has been taken up as phase-I of the project, considering that the concretization of the road has been undertaken, and that all the utilities are in place.

This RFP has been issued by SKDCL for the appointment of an agency for the development of the Kalyan-Murbad Road as smart street, as part of the complete streets network of the smart city proposal of Kalyan-Dombivli city. The salient features of Kalyan-Murbad road is as given below.

Length of the Road (Kalyan-Murbad road from KDMT Bus Depot to Karnik Road T Junction)	1.09 km (Approx)
No. of lanes and carriage way available	4 lanes throughout the road. Width of the road varies from 24 mt to 30 mt. (Annexure I)
Pedestrian footpath available	2 meter footpath available
Parking	The street is a commercial street. On street parking observed on entire length of the street
Bus stops	5 bus stops
Street lights	Street lights installed
Median	Median at entire length of the road (No demolition of median)

1. Objective

The objective of the assignment is to provide direct assistance to SKDCL to ensure the effective implementation of the identified projects. The agency shall be responsible for the execution and implementation of the project and shall include tasks of carrying out the necessary surveys, preparing good for execution drawings as per the designs provided in Annexure-I, procurement of equipment and goods, and construction and commissioning of the project.

2. Scope of work

Scope of work to achieve the objectives is divided into 3 phases

1. Pre Construction Phase – 1 month
2. Construction Phase – 5 Months
3. Post Construction Phase – 12 Months (Defect liability period or DLP)

The works under Contract comprises the construction of proposed improvement of main road in city area as per the RFP standards, Junction, footpaths, development of parking areas & bus bays, landscaping, etc. and all other structures required for the completion of the Works.

- Contractors are requested to visit the site prior to fill/submit the tender and check all the necessary attributes/matters related for completion of this project.
- All the activities required to be carried out for successful and timely completion of this project shall be carried out by the successful contractor.

The works under Contract comprises the construction of proposed improvement of roads , Junction, foot path, development of parking areas & bus bays, Street landscaping, Street Furniture, Traffic Signage's, Bus Shelters, Miscellaneous works and post construction works for Period of one year.

Details and drawings given in document is for information purpose only and successful bidder shall undertake confirmatory survey for accuracy and completeness of data. The drawings provided with this document are also available in Autocad and Bidders can collect the same, (if required) from Employer. It is in scope of successful Bidder to undertake all Site surveys, obtaining all required approvals from the relevant authorities, prepare good for construction drawings for all the components of the work as per Employers requirement and submit the same to client for review and approval, submit maintenance manual to client for approval before start of post construction period.

The successful bidder shall have to prepare and submit both 'Good for Construction Drawings' before execution and 'As Built Drawings' after execution depicting the exact construction carried out on site, in soft and hard copy format. Statutory and other charges for getting various required approvals shall be in scope of Successful bidder.

2.1 Pre-Construction Phase (good for construction drawings)

This phase starts from the date of signing of the Agreement to the date of approval of GFC. The total timeline for this phase is 20 days w.e.f. from the date of signing of Agreement. The components identified for the development of the street as smart street are as follows:

1. Development of footpath with uniform footpath widths and universal access: The contractor shall develop footpath with clear walkway of atleast 2mt with suitable provision for movement of the differently abled, like laying of tactile cues, provisions for ramps wherever possible etc. The contractor shall also refer to MoUD guidelines to provide additional facilities for the movement of the disabled. As per the right of way available, the contractor shall propose for the width of the footpath. Currently, 2 mt wide footpaths are provided for the given stretch. The contractor shall widen the footpath as required as per the GFC drawings. It should be noted that the appointed contractor shall coordinate with the existing contractor and procure and lay the paver blocks of the specifications which are already laid.

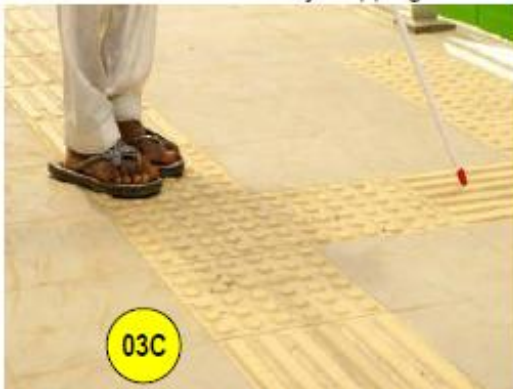

2. Beautification and Landscaping of the footpath and central median: To provide a separation between the carriageway and the footpath, we have proposed for construction of tree planters along the footpaths, as per the proposed cross section of the street, wherever possible. The contractor shall include the tree planters along the footpath as per the right of way available. The planters shall be provided with suitable flower bed, shrubs etc.



3. Provision of street furniture (Signage's, benches, dust bins, lamp post): To facilitate the movement of the people, way finding, proper illumination at newspaper readings spots, we have proposed for installation of signage, benches, lamp posts and dust bins. The contractor shall refer to suitable guidelines such as URDPFI guidelines, and assess the requirements of the street to come up with the distances between the benches, garbage bins, signage requirement etc.
4. Road markings: The contractor appointed by KDMC is to provide road markings. In case of any demolition works, the contractor appointed by SKDCL shall provide suitable road markings.



5. Standard advertisement boards: KDMC has provided advertisement boards on the street lights at 30 metre interval. Standard hoardings as per the design provided in the technical specifications shall be procured and installed at the allocated locations.
6. Raised table top crossings to ensure safe crossing of pedestrians: To ensure the safety of the pedestrians crossing the roads, table top crossings shall be provided at the locations marked in the drawings provided in section 9 as per the technical specification provided. The contractor may make necessary modifications to the designs as per the site situation.



7. Designated parking and hawking zones: Designated hawking and parking zones will be provided with paved blocks as per the existing land use along the stretch. Suitable flexible paver blocks and signage shall be provide for the same.
8. Vending kiosks: We propose for standard vending kiosks at the designated hawking zone, where the vendors/hawkers can set up and sell various items. This will improve the aesthetics of the street.
9. E-toilets: Area dedicated for e-toilets shall be identified, and shall be marked. The procurement and installation of the e-toilets shall be undertaken at a later stage on PPP mode.
10. Pedestrian refuge islands at junctions: For safe crossing of the pedestrians along the junctions, pedestrian refuse islands shall be provided at the major junctions. The contractor shall remove the kerbs and soil as required.

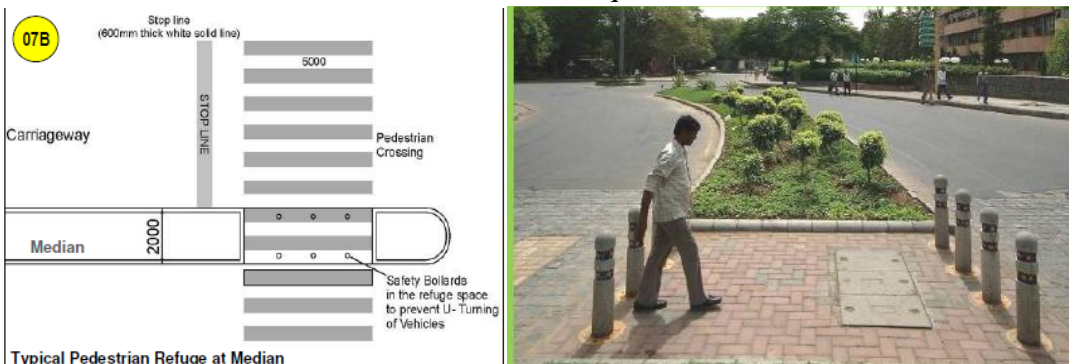

11. Kerb ramps at junctions to ensure safe movement of people using wheelchairs: Kerbed ramps at the junctions and crossings with a minimum gradient of 1:12. The kerbed ramps will facilitate the movement of the people using wheelchairs, aged and differently abled. The contractor shall remove the paver blocks, sub grade and PCC as required for construction of the kerb ramps.

At Signalized Crossings: Use Kerb Cut-Ramp

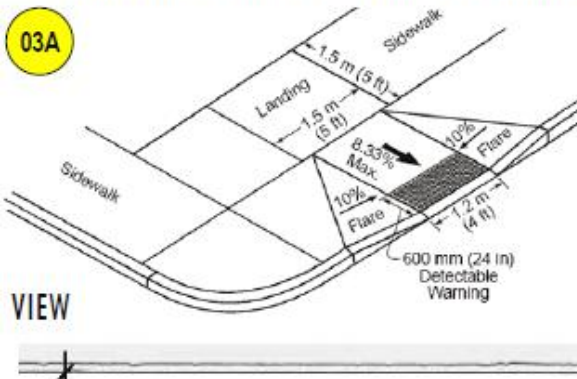

12. Shaded bus stops with LED displays and solar panels: All the existing bus stops along the stretch shall be replaced with shaded bus stops with solar panels.

Kalyan-Dombivli Municipal Corporation had appointed a contractor for the concretization of the Kalyan-Murbad road. The scope of work of the contractor included concretization of roads, laying of kerbs on the median, laying of footpath, laying of kerbs for the footpath, road markings, road studs, laying of shrubs for the median. The contractor appointed for the given RFP shall ensure that minimum demolition of the existing work be done, and that the components damaged shall be re-laid.

Considering the existing infrastructure of the street, proposed components, the drawings/designs provided in section 9, objectives, expected outputs, and the existing traffic situation, the contractors shall create a Good for construction (GFC) drawings package, which on approval, shall be followed by on-site implementation. The GFC drawings shall be created for sections of 400 meters for the entire stretch of 1.9 km. During this process, the contractor shall review the designs and plans provided for betterments or improvements which may be incorporated to better achieve the Employer's goals and objectives. These betterments, if any, shall be submitted by the contractor to the Client representative/PMC for review and for the approval before the closure of the Good for construction drawings stage.

Key tasks/deliverables by the contractor during Good for Construction Stage will include:

- a) The contractor shall prepare GFC for section of 400 metres for the works included in the RFP in accordance with the designs developed by Employer.
- b) The contractor should submit a complete timeline for scope of work to be carried out.
- c) The Client Representative/PMC will supervise and monitor the progress of this phase and contractor shall provide necessary coordination.
- d) Based on the revised cross section, traffic and other relevant parameters, contractor will have to design the geometry of road and pavement etc. and get it vetted and approved by 'Engineer'.
- e) Preparation and Submission of Complete Bill of Materials (BoM) along with detailed technical specifications, manufacturer's details and delivery schedule at the sites. Shall also provide the codification for all the items delivered.

- f) Preparation and submission of the details of the man power deployment for the project.
- g) Dispatch of materials as per the implementation accepted timelines
- h) Preparation and submission of monthly progress report for all the stages.
- i) Employer will provide all the available information pertaining to these roads to the successful bidder. However contractor has to validate the information provided by carrying of field/site surveys/other relevant surveys as deemed necessary independently. The contractor shall conduct site survey and investigation of the road where design has to be implemented and prepare survey report highlighting the site feasibility, GFC drawings, and site specific requirements / dependencies for successful implementation.

Landscape and Hardscape Works

- a) The various components included (but not limited to) in this are – wide footpaths, landscape corridor with trees, pedestrian street lighting, bus bays, on-street parking, road markings, median, hawker zone, improved junctions, table tops, universal accessible design by introduction of ramps, benches and planting beds, provision for future bus stops.
- b) Design and Construction of bus stops, public toilets and ATMs is not part of the contractor scope of work. Although the contractor is required to ensure site coordination and construction activity alignments when these works are being undertaken by other contractors.
- c) General Arrangement Plans (Surface Finishes Layouts) including Materials, Site Furniture, cycle tracks etc.
- d) Levels and Grading Layouts; Material/Lighting/Furniture Schedules; Hardscape Details (including ramps, bus bays, on-street parking and benches); pedestrian Lighting details; planting schedule; planting and soil details
- e) Design and preparation of GFC for items listed in Employers BoQ
 - f) Hard Landscape Specification including all details in Employers Bill of Quantities (BoQ) and Technical Specs
 - g) Softscape Specifications including all details in Employers BoQ and Technical Specs
- h) Final Setting-Out Plan for hardscape, softscape, ; furniture, cycle tracks, footpaths, lighting etc
- i) All detail construction drawings suitable for construction works to be undertaken by contractor and vetted by concerned field experts
- j) All necessary coordinated services drawings (including but not limited to location of light fixtures, cycle tracks, footpaths, existing site services and any new added services etc.)

- k) Shop drawings for all proprietary items/vendor items

The contractor must be aware of general and specific site conditions, topography and any existing landscape prior to commencement of any landscape works on site.

General Conditions of Work:

Prior to starting the works on site Appointed Contractor shall submit the following documentation for approvals:

Detailed Programme of Work for all Works:

- a) Prepare a detailed programme showing the stages, sequence and timing of all parts of work in MS Project (including subcontractors involvement/items and itemised items from Outline Programme of Work); It should include the resources, men, material, equipment required with clear critical path to execute the work as per agreed implementation schedules by employer.
- b) Timelines should be clearly defined. They should include estimated completion date and number of working days;
- c) Programme should include detailed information on resources (manpower, equipment etc.), works by subcontractors etc.;
- d) Schedules are to be coordinated with the main contractor's program and subject to Client's approval;
- e) Method statement for all works, including transport & delivery of materials, site works including earth works, hardworks installation, plant protection, temporary storage etc. should be clearly defined;

Procurement Plan:

Submit a Procurement Plan based on Client Representative's comments regarding the Procurement Schedule (as submitted with the tender document). The submitted Procurement Plan shall provide clear information on the following;

- a) Procurement schedule for all materials (including landscape elements, site furnishings, lighting, bus stops etc.);
- b) Information of Supplier's
- c) Existing and future availability of materials;
- d) Information of Supplier's and/or Contractor's Off- site;
- e) Existing and future availability of materials.

Material/Product samples:

- a) All samples for material are to be submitted as required;
- b) Product certificates for manufactured products should be submitted;
- c) Type and number of samples as specified in relevant sections of this document;

- d) All samples need to be approved by Employer & PMC prior to commencement of works on site.
- e) For material, re-submit list with source and quantity available for each representative materials.
- f) Landscape species should include tree, palm, shrub, climber, bamboo and ground cover species indicating height, spread, calliper and root ball size, for final approval by Client's Representative &PMC. Any agreed substitutions to plants species or specifications should be included here.
- g) Contractor to arrange for visit by Client's Representative and PMC staff to supplier or manufactures site location for a eye witness and material testing to approve selected materials prior to procurement at this own cost (including travel/perdiems/accommodation etc..to the employers representative and PMC staff).

Site Management Plan

Measures to be taken before commencement of works as well as during the works and maintenance period,

- a) Site arrangement layout for temporary structures, storage, water and electricity supply etc.;
- b) PHASING Plan to be submitted for approval to Employer/PMC prior to commencement of site work. Contractor has to ensure that there is little or no disturbance to the traffic, while planning the implementation phasing. Commuters shall be provided with proper signages, warnings, alternative routing etc... after discussions and approvals of Employer/ Engineer. It is to be ensured that at no time during the construction phase, the functioning of each of the roads is to be disturbed or stopped. Consultation will be required with the relevant authorities for construction phasing;
- c) Contractor has to show existing conditions of adjoining construction and site improvements, including finish surfaces that might be misconstrued as damage caused by earthwork operations. Submit before earth work begins.

Health and Safety Plan

- a) Prior to commencing site works the following will be provided to the Client's representative:
- b) Method statements on how risks from hazards will be addressed;
- c) Details of management structure and responsibilities;
- d) Arrangements for issuing health and safety directions;
- e) Procedures for informing other contractors and employees of health and safety hazards;
- f) Procedures for communications between the project team, other contractors and site operatives;

- g) Arrangements for coordination and cooperation between contractors;
- h) Procedures for carrying out risk assessments and for managing and controlling the risks;
- i) Emergency procedures including those for fire prevention and escape;
- j) Arrangements for ensuring that all accidents, illness and dangerous occurrences are recorded;
- k) Arrangements for welfare facilities;
- l) Procedures for ensuring that all persons on site have received relevant health and safety information and training;
- m) Arrangements for consulting and taking the views of people on site;
- n) Arrangements for preparing site rules and drawing them to the attention of those affected and ensuring their compliance;
- o) Monitoring procedures to ensure compliance with site rules, selection of management procedures, health and safety standards and statutory requirements;

Site Waste Management Plan

- a) Plan should include details on type and quantities of the waste generated – including demolition waste, day to day generated waste, disposal of the same safely considering the environmental and social consideration etc.;
- b) Detail description of the waste management methods and actions to minimise/reuse/recycle waste,
- c) Recourses required and detail plan of work for waste management team;
- d) Record keeping procedures;
- e) Auditing protocols;
- f) All of the above should be approved by the Client/Client's representative prior to commencement of works on site. No works shall be executed without above mentioned approvals.

CONSTRUCTION PHASE

This phase starts from the date of approved good for construction drawings (GFC). The total timeline for this phase is 2 months w.e.f the date of approved GFC by client/PMC.

This contract involves the construction and completion of the following based on the design developed by the Employer and Contractor's good for construction drawings and handing over of the same in full accordance with the Employer's requirements. Key tasks include:

- a) Site clearance, demolition works, earthworks, temporary works, Traffic diversion, Barricading the construction site, and all ancillary works as shown on the Drawings and deemed necessary for the carrying out of temporary and permanent construction works;
- b) Contractor has to ensure the safety and security of existing buildings adjacent to roads.

- c) Trees cutting (if any) as indicated in the Drawings;
- d) Supply and installation of new smart poles as shown in the
 - e) Drawings;
- f) Temporary and permanent diversion and restoration of footpath, drains, roads and street furniture including the supply and painting of road/lane markings for all temporary and permanent carriageway in accordance with the Employer's requirements and to the satisfaction of the Engineer;
- g) The contractor should submit a complete implementation timeline
- h) The Client Representative/PMC will supervise and monitor the progress of the implementation and contractor shall provide necessary coordination.
- i) Technical Specifications for Various Civil Works to be followed in the project duration including works under post construction period, by the Selected Bidder

Material/Product samples:

- a) All materials/samples to be submitted to the Client representative & PMC for comments and approval prior to commencement of works;
- b) Type and number of samples as specified in relevant sections of this document Contractor shall arrange factory inspection to the client representative & PMC staff at his own cost for various equipment/ material that is being used by contractor

Sample panels:

- a) Mock-ups All sample panel/mock-up to be presented to the Client/Client's Representative for comments and approval prior to commencement of works;
- b) Type and number of sample panels as specified in relevant sections of this document.
- c) Operations & Maintenance Manual:
- d) This should include schedule and instructions for all activities to be undertaken for operations and maintenance of established works.
- e) As-built drawings:
- f) The Contractor shall prepare As-Built drawings and certify on these drawings that the drawings reflect the actual works executed / installed.
- g) Three sets of these drawings (A1 hardcopy, printed to scale and softcopy in AutoCAD /GIS and also in PDF on a CD/harddisc) shall be submitted to the client post approval and record.
- h) The contractor shall ensure that this submission of As-Built drawings will not delay subsequent inspections and tests by the relevant authorities; otherwise he shall be fully responsible for any consequence due to his delay.

POST CONSTRUCTION

Post construction activities shall include Defect Liability (works specified under this RFP) and also maintenance of roads, landscape and also the utilities laid by the contractor in the smart roads. Any faults, repair and general maintenance, watering of landscape etc. shall start from the date of practical completion for a period of 12 months and contractor shall

undertake all responsibility for defects of the equipment and landscape materials during this period.

GENERAL SCOPE

- a) The work in this RFP involves the design (wherever required, including submission and obtaining of all necessary approvals from the relevant authorities), supply, installation, construction and completion of all road works, utility works, landscape works and allied civil and services work. The Contractor shall furnish all labour, material, tools and equipment necessary to complete the works as indicated on the drawings. Any item not specifically shown in the drawings or specified but normally required to conform to such intent, should be considered part of the work unless raised by the Contractor prior to commencement of works. Contractor shall include and price for such item in the BOQ accordingly;
 - b) All works indicated in the Drawings by notes are to be provided for, whether or not mentioned in this specification. Any item not specified nor specifically shown in the drawings, but are normally required to conform to such intent, are considered part of the work and deemed to be included in this contract and their execution shall be covered by the contract price, in the same manner as if they have been expressly shown on the drawings and described in the specifications.
 - c) Contractor shall provide necessary office space at site with all required amenities to the employers representative and PMC staff during the construction and supervision of works.
 - d) The works shall be completed within the scheduled time and shall be certified by the
 - e) Client's Representative in consultation with the PMC upon Practical Completion;
 - f) The landscape planting shall be provided in the areas shown in the Drawings with plants in a healthy and vigorous growing condition.
 - g) The Contractor shall submit for approval, his proposed Work Programme based on the criteria of the overall programme showing the intended sequences, stages and order of proceeding with the works together with the period of time he has estimated for each and every stage of the progress upon notification of his successful tender price for the project;
- a) ***Adjustments To Scope***
- a) Client's Representative/PMC reserves the right to make field adjustments and reasonable substitutions to ensure implementation of the design concept in relation to field conditions.
 - b) If any material or installation specified is not available or achievable, the Contractor shall submit a written proposal to the client within two (2) weeks of award of the contract. This request may present an alternative material or process which fulfils the same design intent, with the proposed adjustment to the contract price for each item due to the change.

- c) Substitution of materials is not permitted unless authorised in writing by the Client.
 - Timelines
- d) The Contractor shall complete the works within or by the date of completion as set forth in the Contract.

Discrepancies

The Contractor to study the drawings at the time of the tender and notify Client's Representative of any discrepancy at the time of the tender submission.

Error And Omission

- a) The general description of the works mentioned above is only for the guidance of the Contractor and any error or omission shall not constitute ground for claim by the Contractor. The onus for investigating and ensuring the actual extent and nature of the works comprised in this Contract prior to the submission of the quotation is solely with the Contractor. Any doubts should be clarified with the Client's Representative before the quotation is submitted. No claim arising out of lack of clarity or availability of information will be entertained post Contract award. Allowance for any or all of these provisions shall be made in the tender BOQ.
- b) Contractor shall maintain skeleton staff for the works under post construction period and also maintenance

List Of Relevant Documents To Be Referred

This specification to be read in conjunction with:

- c) Concept Design Intent Drawing Package (roadworks, underground / over ground utilities, landscape with allied services, junction design etc) included in Section 9 or most up to date revision issued thereafter;
- d) Bills of Quantities (BoQ) : Indicative list of BoQ, is included in the bid and most up to date revision issued thereafter;
- e) Note: If work item is not included in Indian Standards, appointed contractor should refer to relevant international standard (BS or equivalent). This should be approved by Client's representative prior to commencing any works on site;
- f) Other documents – any documents not included above but relevant to the tender process. These should be provided/made available to Contractor by the Client/Client's representative if applicable.

Services to be provided by the Contractor

The Contractor shall be responsible for all the testing and inspection to be conducted as specified.

1. Supply, erection as per manufacturers recommendations, inspection, testing, start up and running of the equipment during trial run / performance guarantee period at rated capacity and speed.

2. Furnishing all erection and commissioning supervision service. The Contractor shall also arrange for maintenance of equipment during performance guarantee and commissioning period.
3. The Contractor after complete erection and testing shall do application of the final paints of approved colour.
4. The Contractor shall arrange for onsite supervision of technical experts, of equipment's from proprietary supplier as and when necessary until the commissioning and guarantee-run of the plant are completed.

Contractor's Obligations

The Contractor should ensure technical feasibility of their tender offer, after inspecting the site. It must be understood that it is a turnkey project and the firm shall be required to execute every such items of work, which are considered necessary for satisfactory completion, even though such items are not specified in the tender documents.

All the works under the scope are to be designed and executed as per the technical specifications and requirements.

The Contractor can take up the works of site clearance and grading and other mobilisation works with the permission of the Engineer after the award of the Contract. However, before taking up the construction work, the Contractor shall be responsible for preparing and submitting for checking and approval of the following:

- i. Good for construction drawings shall be prepared and shall be submitted for approval and execution process.
- ii. Schedule for designs, drawings & execution, Bar Charts-CPM / PERT charts shall be prepared in Ms Project.

Special conditions to be fulfilled by the Contractor

The Contractor is advised to note that the following special conditions are part of the Contract and he will not have any right to claim at any time for delays or for expenditure incurred by him caused by the following special conditions.

DESIGN DRAWINGS

The drawings issued with these Tender Documents are Design Drawings. These drawings if stands finalized at the time of executing the agreement, together with additional drawings and / or modified drawings, signed and made part of the contract will be called contract drawings. Tender Drawings are prepared in such detail as are necessary to give a comprehensive idea of the works. Any questions or alterations affecting the requirements or information on the Contract Drawings shall be submitted in writing to the **Engineer** and shall be reviewed by the **Engineer**.

The lines indicated on the Contract Drawings denoting locations of the structures are approximate locations. The Contractor is not to assume that they are exact. He has to confirm the exact location of the utilities in consultation with the relevant authorities.

WORKING DRAWINGS

The Design Drawings shall be supplemented by working drawings or shop drawings prepared by the Contractor which are required for the execution of the works. These working drawings shall include, electrical single line drawings, mechanical drawings, piping drawings setting out construction details, layouts, utility relocation and protection, and any other detail the **Engineer** may ask during construction.

All drawings shall be computerized and shall be submitted both in hard copy as well as digital data.

Existing ground levels shall be taken at intervals not exceeding 25m. Information related to all existing structures, obstructions and services should be located in the survey drawing.

Approval by the Engineer of the Contractor's working drawings shall not relieve the Contractor from responsibility for the accuracy of dimensions and details, nor shall such mutual agreement and compliance to his working drawings constitute an acceptance by the Employer of the correctness and adequacy of the drawings.

Working drawings as required or as directed by the Engineer shall be prepared and submitted by the Contractor sufficiently in advance. All working drawings shall be checked by the Engineer and work can commence only upon getting approval of the working drawing.

Delays to work by reason of lack of approvals of working drawings and shop drawings are deemed to be a risk the Contractor is taking with full knowledge and no compensation shall be claimed by the Contractor or none given by the Employer, on account of such delay.

The costs of furnishing working drawings shall be included in the rates for various paying items given in the Bill of Quantities.

In this respect the Contractor shall employ his Engineers and AutoCAD Draughtsmen specifically for planning and preparation of working drawings.

ADDITIONAL WORK

Any additional works, instructed during the Contract Period and within the Contract Amount, will be paid as per Bill of Quantity rates and it shall not be considered as a cause for the Contractor to claim for delay, incurred overhead, mobilization etc.

PROTECTION OF THE WORKS DURING CONTRACT PERIOD

It is clearly understood that any damage occurring to the Works (done or under execution) is the Contractors responsibility and no claims will be entertained by the Employer since the matter shall be covered by the relevant Insurances.

DISCREPANCIES IN ALIGNMENT

The Contractor at his own cost shall rectify discrepancies in alignment and levels etc., noticed during construction and/or on completion, Engineer's approval does not relieve the Contractor of his responsibilities.

Temporary Water Supply

All costs, both for temporary installations and water required for testing of pipelines and tanks, shall be borne by the Contractor.

Performance Bond and Insurances

Payments for Performance Bond (Security Deposit) and for the Insurances shall not be made directly but their costs shall be considered included in the various pay items of the Bill of Quantities.

CONTRACTOR'S FACILITIES

Site offices of the contractor

The successful tenderer is to provide and maintain site office(s) in Project Area as directed by the Engineer.

The Contractor shall submit to the Engineer his proposed layout of the site office for approval. The site office must be ready for use within 15 days from the date of work order or delivery of materials at site, whichever is earlier.

The contractor shall provide updated progress information at site office/s on a computer for the review of the Engineer.

Throughout the whole period as specified below during which the site office is being occupied and used by the contractor, he shall provide, pay for all charges and maintain at his own expense electricity, water and telephone facilities for the site office.

The Contractor shall provide sufficient water tanks to ensure constant supply of potable water for the site office at all times.

The Contractor shall provide acceptable bio digestible septic tank for the staff / workers etc..so that the project area is free from any contamination. This shall be at a distance of more than 10m from any building.

The Contractor shall keep the site office clean and tidy.

The site office with all those provisions mentioned above shall be provided and maintained by the Contractor throughout the whole construction period until three months after the issuance of the Preliminary Handing Over Certificate or until all the work required under the Contract are in the opinion of the Engineer 100% (one hundred percent) completed, whichever ever period is the later one.

The office and its facilities will not, however, be removed from the site without prior written approval of the Engineer

Surveying equipment

The Contractor shall provide, at his own expense one approved set of surveying and measuring equipment for the sole use of the Engineer's Representative. The set shall consist of (i) One

Total Station, (ii) One pogo with reflector, (iii) One big tripod and (iv) One small tripod (v) Two fiber glass tape (cased 30 m) (vi) Four steel pocket tape 3 m long (vii) Two surveying umbrellas (viii) Ten ranging rods 2.5 m long (ix) Required numbers of level books and field books.

All accessories and assistance required for setting out, measuring etc. shall be supplied as and when required by the Engineer / Engineer's representative.

The contractor shall be solely responsible for the maintenance of all such instruments and equipment's and shall ensure that they are at all times in good condition.

All the surveying equipment's shall remain the property of the Contractor at the end of the Contract. The Contractor is obliged to replace any instrument or part thereof damaged during the Contract Period.

There will be no direct payment for surveying equipment. It is deemed to be included in the various paying items in the Bill of Quantities.

Progress photographs and reports

Contractor shall submit monthly 6 progress Photographs 12" x 8" size in five copies as part of his monthly progress report.

Each photograph shall be mounted on A4 size chart paper on which the following information shall be written:

Name of the project

Location

Type of Work

Serial Number of the Photographs

Date of photographs

At the end of the Project the Contractor shall deliver to the Handing over Committee two albums having the most significant Photographs taken during the Contract Period. The cost of photographs and album are deemed to be included in various items of the bill of quantities.

Safety on site

Measures to ensure safety of workers and plant at site shall be taken by the contractor. Excavations shall be protected by barriers and lighting shall be provided at night to warn pedestrians and vehicles. Traffic diversions shall be arranged as per the Traffic management plans which will be issued before commencement of works. The Contractor shall designate a Safety Officer who will be in charge of all Safety Measures. The cost of all safety equipment's and the cost of providing a safety officer at site would be deemed to be included in various Items of the Bill of quantities.

As built drawings

The Contractor shall prepare As Built Drawings both in hard copy and in digital format.

The drawings shall be prepared for any given section of the work as soon as the work for that particular section is completed. Preparation of As built drawings shall keep pace with the work and shall not be left over towards the end of the project. 3 hard copies and one soft copy of all drawings shall be submitted.

No separate payment will be made for the preparation of As-Built Drawings; Cost of preparation of As Built Drawing is deemed to be included in all other priced bill items.

SECTION 5
TECHNICAL SPECIFICATIONS

TECHNICAL SPECIFICATIONS

The contractor shall refer to the following technical specifications issued by CPWD for construction works

1 CEMENT PLASTER

The cement plaster shall be 12 mm, 15 mm or 20 mm thick as specified in the item.

1.1 Preparation of Surface

The joints shall be raked out properly. Dust and loose mortar shall be brushed out. Efflorescence if any shall be removed by brushing and scrapping. The surface shall then be thoroughly washed with water, cleaned and kept wet before plastering is commenced. In case of concrete surface if a chemical retarder has been applied to the form work, the surface shall be roughened by wire brushing and all the resulting dust and loose particles cleaned off and care shall be taken that none of the retarders is left on the surface.

1.2 Mortar

The mortar of the specified mix using the type of sand described in the item shall be used. It shall be as specified in Subhead 3.0. For external work and under coat work, the fine aggregate shall conform to grading IV. For finishing coat work the fine aggregate conforming to grading zone V shall be used.

1.3 Application of Plaster

1.3.1 Ceiling plaster shall be completed before commencement of wall plaster.

1.3.2 Plastering shall be started from the top and worked down towards the floor. All putlog holes shall be properly filled in advance of the plastering as the scaffolding is being taken down. To ensure even thickness and a true surface, plaster about 15 × 15 cm shall be first applied, horizontally and vertically, at not more than 2 metres intervals over the entire surface to serve as gauges. The surfaces of these gauged areas shall be truly in the plane of the finished plaster surface. The mortar shall then be laid on the wall, between the gauges with trowel. The mortar shall be applied in a uniform surface slightly more than the specified thickness. This shall be brought to a true surface, by working a wooden straight edge reaching across the gauges, with small upward and side ways movements at a time. Finally the surface shall be finished off true with trowel or wooden float according as a smooth or a sandy granular texture is required. Excessive troweling or over working the float shall be avoided.

1.3.3 All corners, arrises, angles and junctions shall be truly vertical or horizontal as the case may be and shall be carefully finished. Rounding or chamfering corners, arrises, provision of grooves at junctions etc. where required shall be done without any extra payment. Such rounding, chamfering or grooving shall be carried out with proper templates or battens to the sizes required.

1.3.4 When suspending work at the end of the day, the plaster shall be left, cut clean to line both horizontally and vertically. When recommencing the plastering, the edge of the old work shall be

scrapped cleaned and wetted with cement slurry before plaster is applied to the adjacent areas, to enable the two to properly join together. Plastering work shall be closed at the end of the day on the body of wall and not nearer than 15 cm to any corners or arrises. It shall not be closed on the body of the features such as plasters, bands and cornices, nor at the corners of arrises. Horizontal joints in plaster work shall not also occur on parapet tops and copings as these invariably lead to leakages. The plastering and finishing shall be completed within half an hour of adding water to the dry mortar. No portion of the surface shall be left out initially to be patched up later on. The plastering and finishing shall be completed within half an hour of adding water to the dry mortar.

1.4 Thickness

Where the thickness required as per description of the item is 20 mm the average thickness of the plaster shall not be less than 20 mm whether the wall treated is of brick or stone. In the case of brick work, the minimum thickness over any portion of the surface shall be not less than 15 mm while in case of stone work the minimum thickness over the bushings shall be not less than 12 mm.

1.5 Curing

Curing shall be started as soon as the plaster has hardened sufficiently not to be damaged when watered. The plaster shall be kept wet for a period of at least 7 days. During this period, it shall be suitably protected from all damages at the contractor's expense by such means as the Engineer-in-Charge may approve. The dates on which the plastering is done shall be legibly marked on the various sections plastered so that curing for the specified period thereafter can be watched.

1.6 Finish

The plaster shall be finished to a true and plumb surface and to the proper degree of smoothness as required. The work shall be tested frequently as the work proceeds with a true straight edge not less than 2.5 m long and with plumb bobs. All horizontal lines and surfaces shall be tested with a level and all jambs and corners with a plumb bob as the work proceeds.

1.7 Precaution

Any cracks which appear in the surface and all portions which sound hollow when tapped, or are found to be soft or otherwise defective, shall be cut out in rectangular shape and redone as directed by the Engineer-in-Charge. (i) When ceiling plaster is done, it shall be finished to chamfered edge at an angle at its junction with a suitable tool when plaster is being done. Similarly when the wall plaster is being done, it shall be kept separate from the ceiling plaster by a thin straight groove not deeper than 6 mm drawn with any suitable method with the wall while the plaster is green. (ii) To prevent surface cracks appearing between junctions of column/beam and walls, 150 mm wide chicken wire mesh should be fixed with U nails 150 mm centre to centre before plastering the junction. The plastering of walls and beam/column in one vertical plane should be carried out in one go. For providing and fixing chicken wire mesh with U nails payment shall be made separately.

1.8 Measurements

1.8.1 Length and breadth shall be measured correct to a cm and its area shall be calculated in square metres correct to two places of decimal.

1.8.2 Thickness of the plaster shall be exclusive of the thickness of the key i.e. grooves, or open joints in brick work.

1.8.3 The measurement of wall plaster shall be taken between the walls or partitions (the dimensions before the plaster shall be taken) for the length and from the top of the floor or skirting to the ceiling for the height. Depth of coves or cornices if any shall be deducted.

1.8.4 The following shall be measured separately from wall plaster. (a) Plaster bands 30 cm wide and under (b) Cornice beadings and architraves or architraves moulded wholly in plaster. (c) Circular work not exceeding 6 m in radius.

1.8.5 Plaster over masonry pilasters will be measured and paid for as plaster only.

1.8.6 A coefficient of 1.63 shall be adopted for the measurement of one side plastering on honey comb work having 6 x 10 cm. opening. 13.1.9.7 Moulded cornices and coves. (a) Length shall be measured at the centre of the girth. (b) Moulded cornices and coves shall be given in square metres the area being arrived at by multiplying length by the girth. (c) Flat or weathered top to cornices when exceeding 15 cm in width shall not be included in the girth but measured with the general plaster work. (d) Cornices which are curved in their length shall be measured separately.

1.8.7 Exterior plastering at a height greater than 10 m from average ground level shall be measured separately in each storey height. Patch plastering (in repairs) shall be measured as plastering new work, where the patch exceed 2.5 sqm. extra payment being made for preparing old wall, such as dismantling old plaster, raking out the joints and cleaning the surface. Where the patch does not exceed 2.5 sqm in area it shall be measured under the appropriate item under sub head 'Repairs to Buildings.'

1.8.8 Deductions in measurements, for opening etc. will be regulated as follows:

(a) No deduction will be made for openings or ends of joists, beams, posts, girders, steps etc. upto 0.5 sqm in area and no additions shall be made either, for the jambs, soffits and sills of such openings. The above procedure will apply to both faces of wall.

(b) Deduction for opening exceeding 0.5 sqm but not exceeding 3 sqm each shall be made for reveals, jambs, soffits sills, sills, etc. of these openings.

(i) When both faces of walls are plastered with same plaster, deductions shall be made for one face only.

(ii) When two faces of walls are plastered with different types of plaster or if one face is plastered and other is pointed or one face is plastered and other is unplastered, deduction shall be made from the plaster or pointing on the side of the frame for the doors, windows etc. on which width of reveals is less than that on the other side but no deduction shall be made on the other side. Where width of reveals on both faces of wall are equal, deduction

of 50% of area of opening on each face shall be made from area of plaster and/or pointing as the case may be.

(iii) For opening having door frame equal to or projecting beyond thickness of wall, full deduction for opening shall be made from each plastered face of wall.

(c) For opening exceeding 3 sqm in area, deduction will be made in the measurements for the full opening of the wall treatment on both faces, while at the same time, jambs, sills and soffits will be measured for payment.

In measuring jambs, sills and soffits, deduction shall not be made for the area in contact with the frame of doors, windows etc.

1.8.9 Rate The rate shall include the cost of all labour and materials involved in all the operations described above.

3 POINTING ON BRICK WORK, TILE WORK AND STONE WORK

3.1 Pointing shall be of the type shown in figure below:

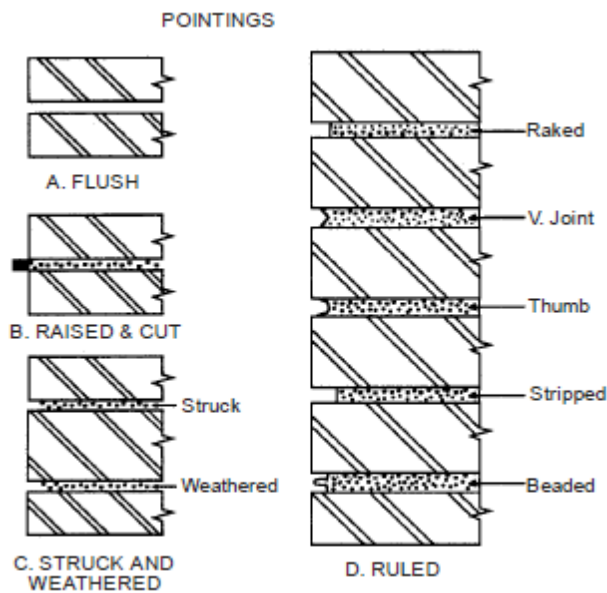

3.2 Scaffolding For all exposed brick work, tile work or stone work independent double scaffolding having two sets of vertical supports shall be provided. The supports shall be sound and strong tied together with horizontal pieces over which scaffolding planks shall be fixed. For all other work in building, single scaffolding shall be permitted. In such cases, the inner end of the horizontal scaffolding pole shall rest in a hole provided only in the header course for the purpose. Only one header for each pole shall be left out. Such holes for scaffolding shall, however, not be allowed in pillars/columns less than one metre in width, or immediately near the skew backs of arches. The holes left in masonry works for scaffolding purposes shall be filled and made good before plastering.

Note: In case of special type of work, scaffolding shall be got approved from Engineer-in-Charge in advance.

3.3 Preparation of surface: The joints shall be raked out properly. Dust and loose mortar shall be brushed out. Efflorescence if any shall be removed by brushing and scraping. The surface shall then be thoroughly washed with water, cleaned and kept wet before pointing is commenced. In case of concrete surface if a chemical retarder has been applied to the form work, the surface shall be roughened by wire brushing and all the resulting dust and loose particles cleaned off and care shall be taken that none of the retarders is left on the surface. The joints shall be raked to such a depth that the minimum depth of the new mortar measured from either the sunk surface of the finished pointing or from the edge of the brick shall not be less than 12 mm.

3.4 Mortar

Mortar of specified mix shall be used. It shall be as specified under Chapter 3.0.

3.5 Application and Finishing

3.6 The mortar shall be pressed into the raked out joints, with a pointing trowel, either flush, sunk or raised, according to the type of pointing required. The mortar shall not spread over the corner, edges or surface of the masonry. The pointing shall then be finished with the proper tool, in the manner described below:

3.6.1 Flush Pointing : The mortar shall be pressed into the joints and shall be finished off flush and level with the edges of the bricks, tiles or stones so as to give a smooth appearance. The edges shall be neatly trimmed with a trowel and straight edge.

3.6.2 Ruled Pointing : The joints shall be initially formed as for flush pointing and then while the mortar is still green, a groove of shape and size as shown in drawings or as instructed, shall be formed by running a forming tool, straight along the centre line of the joints. This operation shall be continued till a smooth and hard surface is obtained. The vertical joints shall also be finished in a similar way. The vertical lines shall make true right angles at their junctions with the horizontal lines and shall not project beyond the same.

3.6.3 Cut or Weather Struck Pointing : The mortar shall first be pressed into the joints. The top of the horizontal joints shall then be neatly pressed back about 3 mm or as directed, with the pointing tool so that the joints are sloping from top to bottom. The vertical joints shall be at true right angles.

3.6.4 Raised and Cut Pointing : Raised and cut pointing shall project from the wall facing with its edges cut parallel so as to have a uniformly raised band about 6 mm raised and width 10 mm more as directed.

3.6.5 The superfluous mortar shall then be cut off from the edges of the lines and the surface of the masonry shall also be cleaned off all mortar. The finish shall be such that the pointing is to the exact size and shape required and the edges are straight, neat and clean.

3.6.7 Curing

The pointing shall be kept wet for seven days. During this period it shall be suitably protected from all damages. The pointing lines shall be truly horizontal and vertical except where the joints are slanting as in rubble random masonry. Lines of joints from different directions should meet neatly at the junctions instead of crossing beyond.

3.7 Measurements

3.7.1 Length and breadth shall be measured correct to a cm and its area shall be calculated in square metres upto two places of decimal.

3.7.2 The various types of pointing for example, struck, keyed, flush, tuck, etc. shall each be measured separately.

3.7.3 Pointing on different types of walls, floors, roofs etc. shall each be measured separately. The type and material of the surface to be pointed shall be described.

3.7.4 Pointing in a single detached joint as for flashing shall be given in running metres.

3.7.5 For jambs, soffits, sills etc. for opening not exceeding 0.5 sqm each in area, ends of joists, beams, posts, girders, steps etc. not exceeding 0.5 sqm each in area and opening not exceeding 3 sqm each deductions and additions shall be made in the following way, in case of pointing on external face only.

(a) No deduction shall be made for ends of joists, beams, posts etc. and openings not exceeding 0.5sqm each, and no addition shall be made for reveals, jambs, soffits, sills, etc. of these openings.

(b) Deductions for openings exceeding 0.5 sqm but not exceeding 3 sqm each shall be made as follows and no additions shall be made for reveals, jambs, soffits, sills, etc. for these openings.

(c) When both the faces of the wall are pointed with the same pointing deduction shall be made for one face only.

(d) When two faces of wall are pointed with different pointings or if one face is plastered and other is pointed or plastered, deduction shall be made from the plaster or pointing on the side of frames for doors, windows, etc. on which the width of the reveal is less than that on the other side, but no deduction shall be made from the other side.

(e) Where width of reveals on both faces of wall are equal, deduction of 50% of area of opening on each face shall be made from area of pointing or plaster as the case may be.

(f) For opening having door frame equal to or projecting beyond thickness of wall, full deduction for opening shall be made from each pointed face of wall.

3.7.6 In case of openings of area above 3 sqm each, deduction shall be made for the openings, but jambs, soffits and sills shall be measured.

3.7.7 The following shall be measured separately.

- (a) Raking out joints for old work only shall be measured and given in square metres.
- (b) Raking out joints of old work built in mud mortar, lime mortar and cement mortar shall each be measured separately.
- (c) Raking out joints of different types of old walls, floors etc. shall each be measured separately.
- (d) Raking single detached joints as for flashing old work shall be given in running metres.

3.8 Rate

The rate shall include the cost of all materials and labour involved in all the operations described above.

4 SUB-GRADE : PREPARATION AND CONSOLIDATION

4.1 In sub-grade composed of clay, fine sand or other soils that may be forced up into the coarse aggregate during rolling operation, an insulation layer of suitable thickness of granular materials or over size brick aggregate not less than 10 cm thick shall be provided for blanketing the sub-grade, which shall be paid for separately, unless otherwise specified. In slushy soils or in areas that are water logged, special arrangements shall be made to improve the sub-grade and the total pavement thickness shall be designed after testing the properties of the subgrade soil. Necessary provision for the special treatment required shall be made in the project and paid for separately.

4.2 Preparation of Sub-Grade

The surface of the formation for a width of sub-base, which shall be 15 cm more on either side of base course, shall first be cut to a depth equal to the combined depth of sub-base and surface courses below the proposed finished level (due allowance being made for consolidation). It shall then be cleaned of all foreign substances. Any ruts or soft yielding patches that appear due to improper drainage conditions, traffic hauling or from any other cause, shall be corrected and the sub-grade dressed off parallel to the finished profile.

4.3 Consolidation

The sub-grade shall be consolidated with a power road roller of 8 to 12 tonnes. The roller shall run

over the sub grade till the soil is evenly and densely consolidated and behaves as an elastic mass (the roller shall pass a minimum of 5 runs on the sub grade). All undulations in the surface that develop due to rolling shall be made good with material or quarry spoils as the cases may be and the sub-grade is rerolled.

4.4 Surface Regularity

The finished surface shall be uniform and conform to the lines, grades and typical cross section shown in the drawings, when tested with the template and straight edge, the variation shall be within the tolerances specified in Table 16.11.

TABLE 16.11
Permissible Tolerances of Surface Evenness of Sub Grade

<i>Longitudinal profile maximum permissible undulation when measured with a 3 metre straight edge</i>	<i>Cross profile maximum permissible variation from specified profile when measured with a camber template</i>
24 mm	15 mm

Where the surface irregularity of the sub grade falls outside the specified tolerances, the contractor shall be liable to rectify these with fresh material or quarry spoils as the case may be, and the sub-grade rerolled to the satisfaction of Engineer-in-Charge.

4.5 Measurements

The length and width shall be measured correct to a cm. The area shall be worked out in square metre, correct to two places of decimal.

4.6 Rate

The rate for preparation and consolidation of sub grade shall include the cost of materials and labour involved for all the operations mentioned in above unless otherwise specified.

6 BOUNDARY STONES (HARD STONE)

6.1 Boundary stones shall be as described in 16.1.21 or of size otherwise specified or directed by the Engineer-in-Charge.

6.2 Spacing and Fixing

The boundary stones shall be fixed as directed by Engineer-in-Charge at intervals of 200 m or less,

where the boundary is in a curve or the land is costly and is likely to be encroached upon, and (ii) at all angular points of the road boundary. The boundary stones shall be firmly fixed in ground to a depth of 60 cm and the side filling shall be thoroughly watered and consolidated. The lower 60 cm portion of the boundary stones shall be encased on all sides by at least 15 cm of foundation concrete 1:5:10 (1 cement : 5 fine sand : 10 graded stone aggregate 40 mm nominal size) in case (a) where wet cultivation abuts the road land and boundary stones are likely to be displaced during

agricultural operations (b) where the road runs in built up area, and (c) where the boundary stones are intended to serve as permanent land marks.

6.3 Measurements & Rate

Boundary stone shall be enumerated. The rate shall include the cost of materials and labour involved in all the operations described above.

7 RETRO REFLECTIVE SIGN BOARD

7.0 General

The colour, configuration, size and location of all the traffic signs for highways other than Express ways shall be in accordance with the code of practice for road signs, IRC:67 or as shown on the drawings. For expressways, the size of the signage, letters and their placement shall be as specified in the contract drawings and relevant specifications or as directed by the Engineer-in-Charge.

7.1 Materials

7.1 Retro-Reflective Sheeting (High Intensity Grade Sheeting of Encapsulated Lens Type):

The sheeting to be white or coloured having a smooth outer surface having the property of retroreflection over its entire surface shall be weather-resistant and show colour fastness. It shall be new and unused and shall show no evidence of cracking, scaling, pitting, blistering, edge lighters curling and shall have negligible shrinkage or expansions.

A certificate of having tested the sheeting for these properties in an unprotected outdoor exposure facing the sun for two years and its having passed these tests shall be obtained from a reputed laboratory by the manufacture of the sheeting.

This sheeting consists of spherical glass lens, elements adhered to a synthetic resin and encapsulated by a flexible, transparent, water proof plastic having a smooth surface.

The retro-reflecting surface after cleaning with soap and water and in dry condition shall have minimum co-efficient of retro reflection (Conforming to ASTM standard E: 810).

When totally wet, the sheeting shall not show less than 90 per cent of the values of retro-reflection.

At the end of 7 years, the sheeting shall return at least 75 per cent of its original retro-reflectance.

7.1.2 Adhesives : The sheeting shall be tack free adhesive activated by heat, applied in a heat vacuum applicator, in a manner recommended by the sheeting manufacturer and approved by Engineer-in-Charge. The adhesive shall be protected by an easily removable liner (removable by peeling without soaking in water or other solvent) and shall be suitable for the type of material of the base plate used for sign. Adhesive shall form a durable bond to smooth, corrosion and weather resistant surface of the base plate such that it shall not be possible to remove the sheeting from the sign base in one piece by use of sharp instrument.

7.2 Installation

7.2.1 Surface to be reflectorised shall be effectively prepared to receive the retro-reflective sheeting. The aluminium sheeting shall be de-greased either by acid or hot alkaline etching and all scale/dust removed to obtain a smooth plain surface before the application of retro-reflective sheeting. Complete sheet of the material shall be used on the signs except where it is unavoidable. Sheeting with heatactivated adhesives may be spliced with an overlap not less than

5 mm or butted with a gap not exceeding 0.75 mm. The material shall cover the sign surface evenly and shall be free from twists, cracks and folds.

7.2.2 Sign posts, their foundations and sign mountings shall be so constructed as to hold these in a proper and permanent position against the normal storm wind load or displacement by vandalism. Normally, sign with an area upto 0.9 sq.m shall be mounted on a single post and for greater area two or more supports shall be provided. Sign supports shall be as specified in item or as per directions of Engineer-in-Charge. The work of foundation shall conform to relevant specification as specified.

7.2.3 Backside of aluminium sheet portion shall be painted with two coats of epoxy paint. Any part and support frame with two or more coats of synthetic enamel paint.

7.3 Warranty and Durability

The Contractor shall obtain from the manufacturer a seven-year warranty for satisfactory performance including stipulated retro-reflectance of the retro-reflective sheeting and submit the same to the Engineer-in-Charge. Processed and applied in accordance with recommended procedures, the reflective material shall be weather resistant and following cleaning, shall show no appreciable discolouration, cracking, blistering or dimensional change and shall not have less than 50 percent of the specified minimum reflective intensity values when subjected to accelerated weathering of 1000 hours, using type E or EH Weatherometer (AASHTO Designation M 268).

7.4 Measurement

These shall be measured in square meters upto two place of decimal.

7.5 Rate

The rate includes the cost of materials, labour and equipments involved in all the operations described above.

8 RETRO REFLECTIVE OVERHEAD SIGNAGE

8.0 General

Overhead signs may be used in lieu of, or as an adjunct to, ground signs where the situation so warrants for proper information and guidance of the road user. The support system should be properly designed based on sound engineering principles, to safely sustain the dead load, live load and wind load on the completed sign system. For this purpose, the overhead signs shall be designed to withstand a wind loading of 150 kg/m² normal to the face of the sign and 30 kg/m² transverse to the face of the sign. In addition to the dead load of the structure, walkway loading of 250kg concentrated live load shall also be considered for the design of the overhead sign structure.

8.1 Height

Overhead signs shall provide a vertical clearance of not less than 5.5 m over the entire width of the pavement and shoulders except where a lesser vertical clearance is used for the design of other

structures. The vertical clearance to overhead sign structures or supports need not to be greater than 300 mm in excess of the minimum design clearance of other structures.

8.2 Lateral Clearance

8.2.1 The minimum clearance outside the usable roadway shoulder for expressway sign mounted at the road side or for overhead sign supports either to the right or left side of the roadways shall be 1.80 m. This minimum clearance of 1.80 m shall also apply outside of an unmountable kerb. Where practicable, a sign should not be less than 3 m from the edge of the nearest traffic lane.

8.2.2 Where a median is 3.6 m or less in width, consideration should be given to spanning over both roadways without a central support. Where overhead sign supports cannot be placed at a safe distance away from the line of traffic or in an otherwise protected site, they should either be so designed as to minimise the impact forces or protect motorists adequately by a physical barrier or guard rail of suitable design.

8.3 Number of Signs at an Overhead Installation

In no case should there be more than three signs displayed at any one location, including regulatory or warning signs, either on the overhead structure or on its support.

8.4 Materials for Overhead Sign and Support Structures

8.4.1 Aluminium alloy or galvanized steel to be used as truss design supports shall conform to relevant IS. These shall be of sections and type as per structural design requirements as shown on the plans.

8.4.2 Plates and support sections for sign posts shall conform to IS 226 and IS 2062.

8.4.3 The overhead signs shall be reflectorised with high intensity retro-reflective sheeting of encapsulated lens type.

8.5 Size, Locations, etc of Signs

8.5.1 The size of the signs, letter and their placement shall be as specified in the Contract drawings and specifications as per direction of Engineer-in-Charge.

8.6 Installation

8.6.1 The supporting structure and signs shall be fabricated and erected as per details given in the plans.

8.6.2 Sign posts, their foundations and sign mountings shall be so constructed as to hold sign in a proper and permanent position to adequately resist swaying in the wind or displacement by vandalism.

8.6.3 The work of construction of foundation for sign supports including excavation and backfill, forms, steel reinforcement, concrete and its placement shall conform to the relevant specifications given in this specification.

8.6.4 The structures shall be erected with the specified camber and in such a manner as to prevent excessive stresses, injury and defacement.

8.6.5 Brackets shall be provided for mounting signs of the type to be supported by the structure. For better visibility, they shall be adjustable to permit mounting the sign faces at any angle between a truly vertical position and three degree from vertical. This angle shall be obtained by rotating the front lower edge of the sign forward. All brackets shall be of a length equal to the heights of the signs being supported.

8.6.6 Before erecting support structures, the bottom of each base plate shall be protected with an approved material which will adequately prevent any harmful reaction between the plate and the concrete.

8.6.7 The end supports shall be plumbed by the use of levelling nuts and the space between the foundation and base plate shall be completely filled with an anti-shrink grout.

8.6.8 Anchor bolts for sign supports shall be set to proper locations and elevation with templates and carefully checked after construction of the sign foundation and before the concrete has set.

8.6.9 All nuts on aluminium trusses, except those used on the flanges, shall be tightened only until they are snug. This includes the nuts on the anchor bolts. A thread lubricant shall be used with each aluminium nut.

8.6.10 All nuts on galvanized steel trusses, with the exception of high strength bolt connections, shall be tightened only to a snug condition.

8.6.11 Field welding shall not be permitted.

8.6.12 After installation of signs is completed, the sign shall be inspected by the Engineer. If specular reflection is apparent on any sign, its positioning shall be adjusted by the Contractor to eliminate or minimize this condition.

8.7 Measurement

These shall be measured in sqmetereupto two place of decimal.

8.8 Rate

The rate includes the cost of materials, labour and equipments involved in all the operations described above.

9 KERB CHANNEL OF CEMENT CONCRETE

Base: The base of the channel to be of the 75 mm compacted thick dry brick ballast 40 mmnominal size well rammed and consolidated and grouted with fine sand.

Kerb channel shall be provided in cement concrete of specified grade. These shall be cast in-situ of specified size as given in the item. Top surface of channel to be finished smooth.

Measurements: Cement concrete channel shall be measured in metre of length of the completed channel correct upto two places of decimal.

Rate: The rate includes the cost of all the materials, labours and tools required in all the operations described above.

10 FACTORY MADE CEMENT CONCRETE INTERLOCKING PAVER BLOCK

10.1 Base

Interlocking paver block to be fixed on the bed 50 mm or specified otherwise thick of coarse sand of approved specification and filling the joints with the sand of approved type and quality or as specified and as directed by Engineer-in-charge.

10.2 Interlocking Paver Block

Factory made precast paver block of M-30 or otherwise specified grade to be used. Paver blocks to be of approved brand and manufacturer and of approved quality. Minimum strength as prescribed by manufacturer and as per direction of Engineer-in-Charge for the grade specified to be tested as per method mentioned in specification of subhead cement concrete of CPWD Specification 2009 Vol. I.

10.3 Measurement & Rates

Area provided with paver block to be measured in sqm. correct upto two places of decimal. The rate include the cost of the material, labour, tools etc. required in all the operations described above.

11 KERB STONE (PRECAST)

11.1 Laying

11.1.1 Trenches shall first be made along the edge of the wearing course of the road to receive the kerb stones of cement concrete of specified grade. The bed of the trenches shall be compacted manually with steel rammers to a firm and even surface and then the stones shall be set in cement mortar of specified proportion.

11.1.2 The kerb stones with top 20 cm. wide shall be laid with their length running parallel to the road edge, true in line and gradient at a distance of 30 cm. from the road edge to allow for the

channel and shall project about 12.5 cm. above the latter. The channel stones with top 30 cm. wide shall be laid in position in chamber with finished road surface and with sufficient slope towards the road gully chamber. The joints of kerb and channel stones shall be staggered and shall be not more than 10 mm. Wherever specified all joints shall be filled with mortar 1:3 (1 cement : 3 coarse sand) and pointed with mortar 1:2 (1 cement: 2 fine sand) which shall be cured for 7 days.

11.1.3 The necessary drainage openings of specified sizes shall be made through the kerb as per drawings or as directed by the Engineer-in-Charge for connecting to storm water drains.

11.2 Finishing

Berms and road edges shall be restored and all surplus earth including rubbish etc. disposed off as directed by the Engineer-in-charge. Nothing extra shall be paid for this.

11.3 Measurements

It shall be measured in cubic meters with Length of the finished work (for specified width and height of stone) shall be measured in running metre along the edge of the road correct to a cm.

11.4 Rate

The rate shall include the cost of all the materials and labour involved in all the operations described above.

Sub Head : Road Work

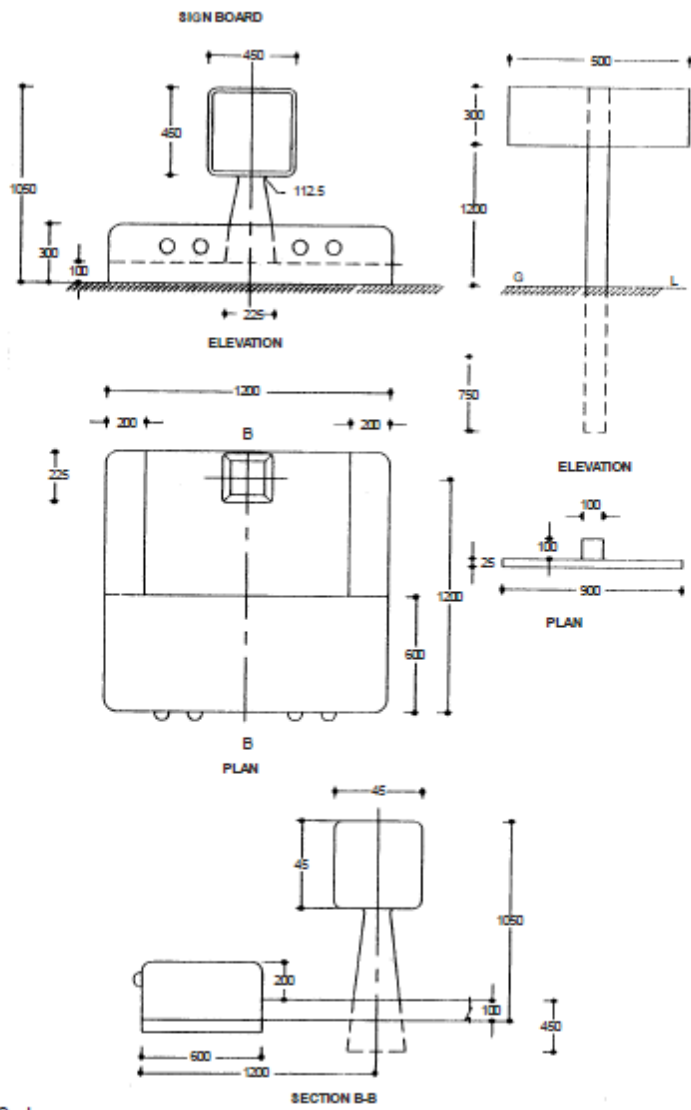

Drawing not to Scale
 All dimensions are in mm
 Red Reflectors ○ ◻

Fig. 16.3 : Sign/Name Board

STANDARD NUMERALS

Sub Head : Road Work
Clause : 16.19

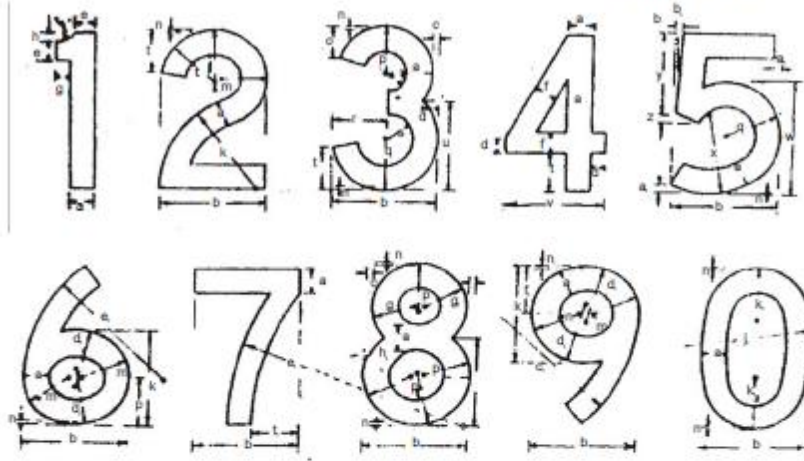

TABLE - I

Height of Numeral	DIMENSIONS																																				
	a	b	c	d	e	f	g	h	i	j	k	l	m	n	o	p	q	r	s	t	u	v	w	x	y	z											
80	13	4	54	2	3	71	8	29	10	120	11	24	7	21	5	9	26	56	31	80	46	28	21	23	1	16	24	27	28	12	20	45	51	58	41	41	4
100	16	5	67	2	4	89	9	36	13	150	14	30	9	26	6	12	33	70	39	100	61	32	27	29	2	20	30	34	34	15	25	56	64	72	51	52	5
130	20	7	87	3	5	116	12	47	16	195	18	38	11	34	8	15	43	91	51	130	79	42	35	38	2	26	40	44	46	19	33	73	83	93	66	67	6

TABLE - II
SPACING BETWEEN NUMERAL

Code Number	Numeral Height		
	80	100	130
1	19	24	31
2	15	19	24
3	10	13	16
4	5	6	8

TABLE - III
NUMERAL CODE NUMBER

Preceding Numeral	Following Numeral		
	1, 5	2, 3, 6, 8, 9, 0	4, 7
1	1	1	2
2	1	2	2
3	1	2	2
4	2	2	4
5	1	2	2
6	1	2	2
7	2	2	4
8	1	2	2
9	1	2	2
0	1	2	2

Note : To determine the proper spacing between numerals obtain the code number from Table III and enter Table II for that Code Number to Desired Numeral Height. Spacing is measured horizontally from the extreme right edge of the preceding numeral to the extreme left of the following numeral. For Dimensions of numerals of different heights see Table I.

Drawing not to scale
All dimensions are in mm

Fig. 16.5 : Standard Numerals

STANDARD LETTERS

Sub Head : Road Work
Clause : 16.19

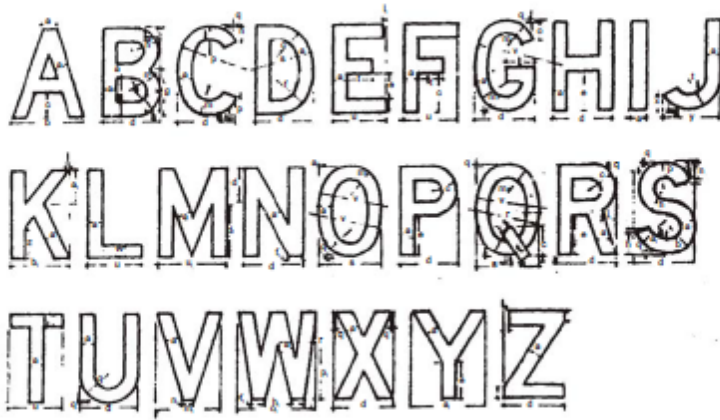

TABLE - I

Height of Letter	DIMENSIONS																																												
	a	b	c	d	e	f	g	h	i	l	j	k	l	m	n	o	p	q	r	s	t	u	v	w	x	y	z																		
80	13	31	67	56	23	82	56	46	35	27	2	11	42	6	20	4	22	14	13	26	3	25	26	3	26	60	16	10	16	70	63	51	1	58	28	11	56	8	23	45	80	12	14	60	26
100	16	39	84	69	28	77	67	58	44	34	2	14	52	8	25	5	27	17	16	30	3	31	53	4	32	79	20	15	22	88	73	64	2	84	36	13	79	9	29	61	100	15	18	5	34
130	20	51	109	89	37	101	87	75	57	44	3	18	68	10	33	6	36	22	21	40	4	31	43	4	42	98	28	16	28	116	100	83	2	110	47	17	91	12	35	79	130	19	23	8	46

TABLE - II
SPACING BETWEEN LETTERS

Code Number	Height of Letter		
	80	100	130
5	80	100	130
12	19	24	31
9	15	19	24
6	10	13	18
3	5	6	8

TABLE - III
LETTER CODE NUMBER

Preceding Letter	Following Letter		
	B, D, E, F, H, I, K, L, M, N, P, R, U	C, G, O, Q, S, X, Z	A, J, T, U, W, Y
A	2		4
B	1		2
C	2		2
D	1		2
E	2		2
F	1		2
G	1		2
H	1		2
I	1		2
J	1		2
K	2		2
L	2		2
M	1		2
N	1		2
O	1		2
P	1		2
Q	1		2
R	1		2
S	1		2
T	1		2
U	1		2
V	1		2
W	1		2
X	1		2
Y	1		2
Z	1		2

Note : To determine the proper spacing between letters obtain the code number from Table III and enter Table II for that Code Number to Desired Height. Spacing is measured horizontally from the extreme right edge of the preceding Letter to the extreme left edge of the following letter. For Dimensions of letters of different heights, see Table I.

Drawing not to scale
All dimensions are in mm

Fig. 16.6 : Standard Letters

INFORMATORY SIGN BOARD

Sub Head : Road Work
 Clause : 16.49

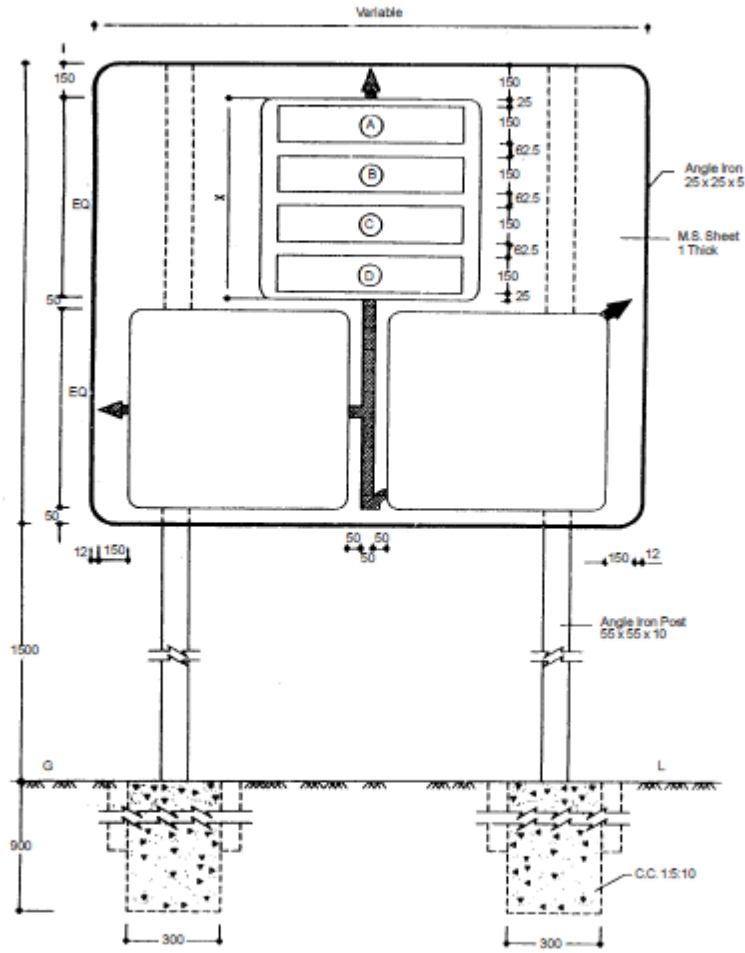

- X = 837.5 for Four Languages
- = 625 for Three Languages
- = 412.5 for Two Languages
- ABCD = Space for writing Names in Languages

Drawing not to Scale
 All dimensions are in mm

LOCATION OF INFORMATORY SIGN BOARDS

Sub Head : Road Work
Clause : 16.49

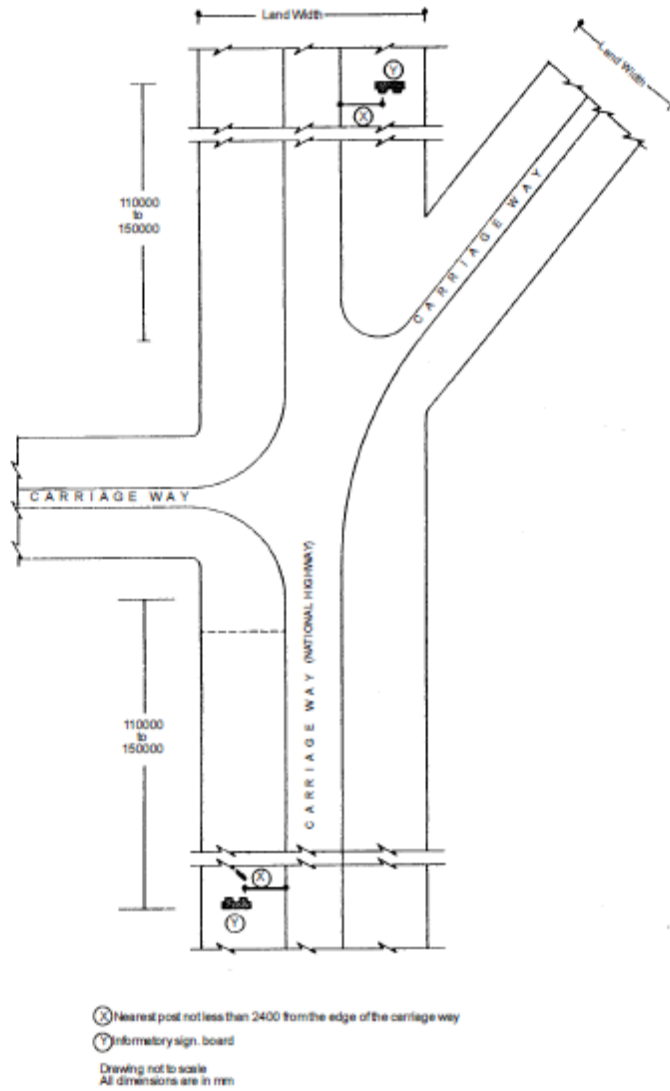
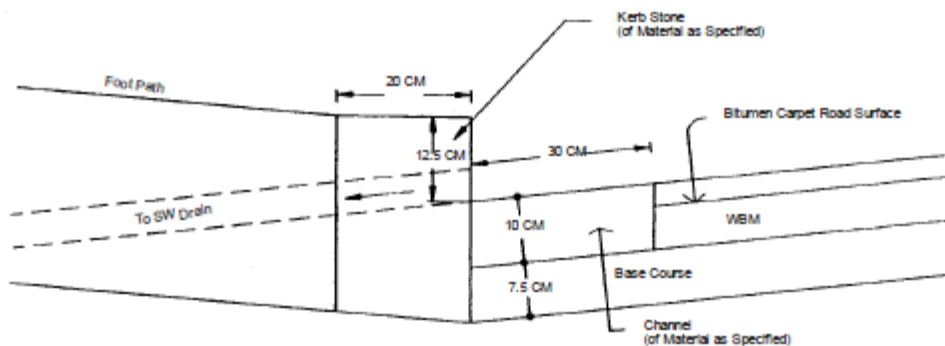

Fig. 16.11 : Location of Informatory Sign Boards

KERB & CHANNEL STONES

Sub Head : Road Work
Clause : 16.1.20



Drawing not to Scale
All dimensions are in mm

Fig. 16.12 : Kerb & Channel Stones

12 HORTICULTURE AND LAND SCAPING

12.0 HORTICULTURE WORK

Horticultural operations shall be started on ground previously levelled and dressed to required formation levels and slopes. In case where unsuitable soil is met with, it shall be either removed or, replaced or it shall be covered over to a thickness decided by the Engineer-in-charge with good earth. In the course of excavation or trenching during horticultural operations, any walls, foundations, etc. met with shall not be dismantled without pre-measurement and prior to the written permission of the Engineer-in-charge.

12.1 TRENCHING IN ORDINARY SOIL

12.1.0 Trenching is done in order to loosen the soil, turn over the top layer containing weeds etc. and to bring up the lower layer of good earth to form a proper medium for grassing, regrassing, hedging and shrubbery.

Trenching shall be done to the depth ordered by the Engineer-in-charge. The depth is generally 30 cm for grassing and 60 cm for regrassing in good soil.

12.1.1 The trenched ground shall, after rough dress, be flooded with water by making small kiaries to enable the soil to settle down. Any local depression unevenness etc. shall be made good by dressing and/or filling with good soil.

12.1.2 Weeds or other vegetation which appear on the ground are then uprooted and removed and disposed off and paid.

12.1.3 Trenching

Trenching shall consist of the following operations:

1. The whole plot shall be divided into narrow rectangular strips of about 1.5 m width or as directed by the Engineer-in-Charge.
2. These strips shall be sub-divided lengthwise into about 1 m long sections. Such sections shall be excavated serially and excavated soil deposited in the adjacent section preceding it.
3. In excavating and depositing care shall be taken that the top soil with all previous plant growth including roots, get buried in the bottom layer of trenched area, the dead plants so buried incidentally being formed into humus.
4. The excavated soil shall be straight away dumped into the adjoining sections so that double handling otherwise involved in dumping the excavated stuff outside and in back filling in the trenches with leads is practically eliminated.

12.1.4 Measurements

Length and breadth of the plot shall be taken correct to 0.1 m and depths correct to cm. Cubical contents shall be calculated in cubic meters, correct to two places of decimal. No deduction shall be made nor extra paid for removing stones, brick bats and other foreign matter met with during excavation up to initial lead of 50 m and stacking the same.

12.1.5 Rate

The rate shall include the cost of all labour and material involved in the operations described above, including cost of all precautionary measures to be taken for protections and supporting all services etc. met with during trenching. It does not include the cost of mixing of earth, sludge/manure.

13 GOOD EARTH

13.1 The earth shall be stacked at site in stacks not less than 50 cm high and of volume not less than 3.0 cum.

13.2 Measurements: Length, breadth and height of stacks shall be measured correct to a cm. The volume of the stacks shall be reduced by 20% for voids before payment, unless otherwise described.

13.3 Rate: The rate shall include the cost of excavating the earth from areas lying at distance not exceeding one km. from the site, transporting the same at site breaking of clods and stacking at places indicated. The rate shall also include royalty if payable.

14 UPROOTING WEEDS FROM TRENCHED AREAS

14.1 After 10 days and within 15 days of flooding the rough dressed trenched ground with water, the weeds appearing on the ground shall be rooted out carefully and the rubbish disposed off as directed by the Engineer-in-charge.

14.2 Measurements

Length, breadth of superficial area shall be measured correct to 0.1 meters. Superficial area of the weeded ground shall be measured for purpose of payments.

14.3 Rate

The rate shall include the cost of all the labour and material involved in all the operations described above.

15 FINE DRESSING THE GROUND

15.1 Slight unevenness, ups, and downs and shallow depressions resulting from the settlement of the flooded ground, in drying and from the subsequent weeding operations, shall be removed by fine dressing the surface to the formation levels of the adjoining land as directed by the Engineer-in-charge, and by adding suitable quantities of good earth brought from outside, if necessary.

15.2 Measurements

Length, breadth and depth of stacks shall be measured correct to a cm. The area shall be calculated in sqm. correct to two places of decimal.

15.3 Rate

The rate shall include the cost of all the labour and material involved in all the operations described above.

16. SPREADING GOOD EARTH

16.1 Good earth shall be removed from stacks by head load and spread evenly over the surface to the thickness ordered by the Engineer-in-charge. It shall be spread with a twisting motion to avoid segregation and to ensure that spreading is uniform over the entire area.

16.2 Measurements: The quantity of good earth spread shall be determined by the difference in the volume of good earth in stacks before and after spreading duly reduced for looseness in stacking by 20% of good earth.

16.3 Rate: The rate shall include of all the labour and material involved in all the operations described above, but does not include the cost of the good earth which shall be paid for separately unless specifically described in the item.

17.A SPREADING SLUDGE/MANURE

23.8.A.1 Good earth shall be thoroughly mixed with sludge or manure in specified proportion as described in the item or as directed by the Engineer-in-Charge. The mixing shall be spread as described in 23.9.1 to the thickness ordered by the Engineer-in-Charge.

17.A.2 Measurements

The quantity of good earth and sludge or manure mixed shall be determined by the difference in the volume of good earth and sludge or manure in stack, before and after spreading duly accounted for voids and looseness in stack.

18.A.3 Rate

The rate shall include of all the labour and material involved in all the operations described above, but does not include the cost of good earth sludge or manure which shall be paid for separately, unless otherwise described in the item.

19 MIXING OF GOOD EARTH AND SLUDGE/MANURE

19.1 The stacked earth shall, before mixing be broken down top particle of sizes not exceeding 6 mm in any direction. Good earth shall be thoroughly mixed with sludge or manure in specified proportion as described in the item or as directed by the Engineer-in-charge.

19.2 Measurements

The quantity of good earth and sludge or manure mixed shall be determined by the difference in the volume of good earth, sludge or manure in stack, before and after spreading duly accounted for voids and looseness in stack.

19.3 Rate

The rate shall include the cost of all labour and materials involved in all the operations described above, but does not include the cost of good earth sludge or manure which shall be paid for separately, unless otherwise described in the item.

20 GRASSING WITH SELECT GRASS NO. 1

20.0 The area from where the grass roots are to be obtained shall be specified by the Engineer-in-Charge at the time of execution of the work and no royalty shall be charged on this account from the contractor.

Grass is to be arranged by contractor (cost of grass to be paid separately).

20.1 The soil shall be suitably moistened and then the operation of planting grass shall be commenced. The grass shall be dibbled at 10 cm, 7.5 cm, 5 cm apart in any direction or other

spacing as described in the item. Dead grass and weeded shall not be planted. The contractor shall be responsible for watering and maintenance of levels and the lawn for 30 days or till the grass forms a thick lawn free from weeded and fit for mowing whichever is later. Generally planting in other direction at 15 cm, 10 cm, spacing is done in the case of large open spaces, at 7.5 cm spacing in residential lawn and at 5cm spacing for Tennis Court and sports ground lawn. Rates are including cost of labour and material (**grass shall be paid separately.**)

20.2 During the maintenance period, any irregularities arising in ground levels due to watering or due to trampling by labour, or due to cattle straying thereon, shall be constantly made up to the proper levels with earth as available or brought from outside as necessary, Constant watch shall be maintained to ensure that dead patches are replanted and weeds are removed.

20.3 Measurements

Length, breadth of the lawn grassed shall be measured correct to 0.1 meter and the area shall be calculated in sqm. correct to two places of decimal.

20.4 Rate

The rate shall include of all the labour and material involved in all the operations described above, excluding supply of the requisite quantity of good earth and grass so needed for properly maintaining the levels of the lawns. (**payment of grass to be paid separately.**)

21 RENOVATION OF LAWNS

21.1 The area shall be first weeded out of all undesirable growth. The entire grass shall be scrapped (cheeled) without damaging roots and level of the grounds. Slight irregularities in surface shall be levelled off and the area shall then be forked so as to aerate the roots of the grass without, however uprooting them.

Specified quantity of sludge or manure shall than be spread uniformly with wooden straight edge (phatti) as directed by the Engineer-in-charge. The area shall then be slightly sprinkled with water so as to facilitate proper integration of the manure or sludge with the soil and later flooded. The contractor shall be responsible for watering, proper maintenance and tending of the lawn for 30 days or till the grass forms a lawn fit for mowing, whichever is later.

During the above operations, all undesirable growths shall be constantly weeded out and all rubbish removed and disposed off as directed by the Engineer-in-Charge.

21.2 Measurements

Length, breadth of the lawn renovated shall be measured correct to 0.1 meter and the area shall be calculated in sqm. correct to two places of decimal.

21.3 Rate

The rate shall include of all the labour and T&P (excluding RH pipe/grass) involved in all the operations described above, excluding the supply of the requisite quantity of good earth if so needed for proper maintenance of the levels of the lawns. The cost of the sludge or manure shall

be measured and paid for separately, unless its supply is specifically included in the description of the item.

22. Walkways with provision of movement of differently abled

To accommodate the handicapped and elderly people each building and its site should be planned and designed as an integral unit from the very beginning of the design process.

WALKS AND PATHS

- Walks should be smooth, hard level surface suitable for walking and wheeling. Irregular surfaces as cobble stones, coarsely exposed aggregate concrete, bricks etc. often cause bumpy rides.
- The minimum walk way width would be 1200 mm and for moderate two way traffic it should be 1650 .mm - 1800 mm.
- Longitudinal walk gradient should be 3 to 5% (30 mm - 50 mm in 1 meter)
- When walks exceed 60 Meter in length it is desirable to provide rest area adjacent to the walk at convenient intervals with space for bench seats. For comfort the seat should be between 350 mm - 425 mm high but not over 450 mm.
- Texture change in walk ways adjacent to seating will be desirable for blind persons.
- Avoid grates and manholes in walks. If grates cannot be avoided then bearing bar should be perpendicular to the travel path and no opening between bearing bars greater than 12 mm in width.

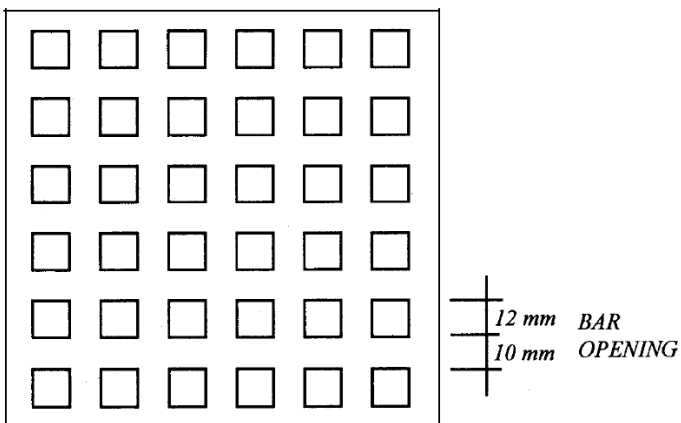

Details of grating

LEVELS AND GROOVES

- (Passing over different levels and grooves)
- The casters on a wheelchair are about 180 mm in diameter. Therefore, a wheelchair can only get over a small level difference.
- Use a method that can reduce the height of the level difference, in addition to the methods shown here.



Difference in level

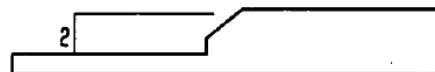

Shape of level

difference

- It can be difficult to move a wheelchair if a caster is caught in a groove.
- It is desirable that there is no difference in level. (If a difference is unavoidable, limit it to 20 mm or less.)
- Round off or bevel the edge.
- To prevent a wheelchair from getting its casters caught in a drainage ditch or other cover.
- Install grating with narrow slots in the direction of movement.
- Treat the grating with a non-slip finish.
- Reduce the gap between an elevator floor and the landing.

Typical Detail of Walkway

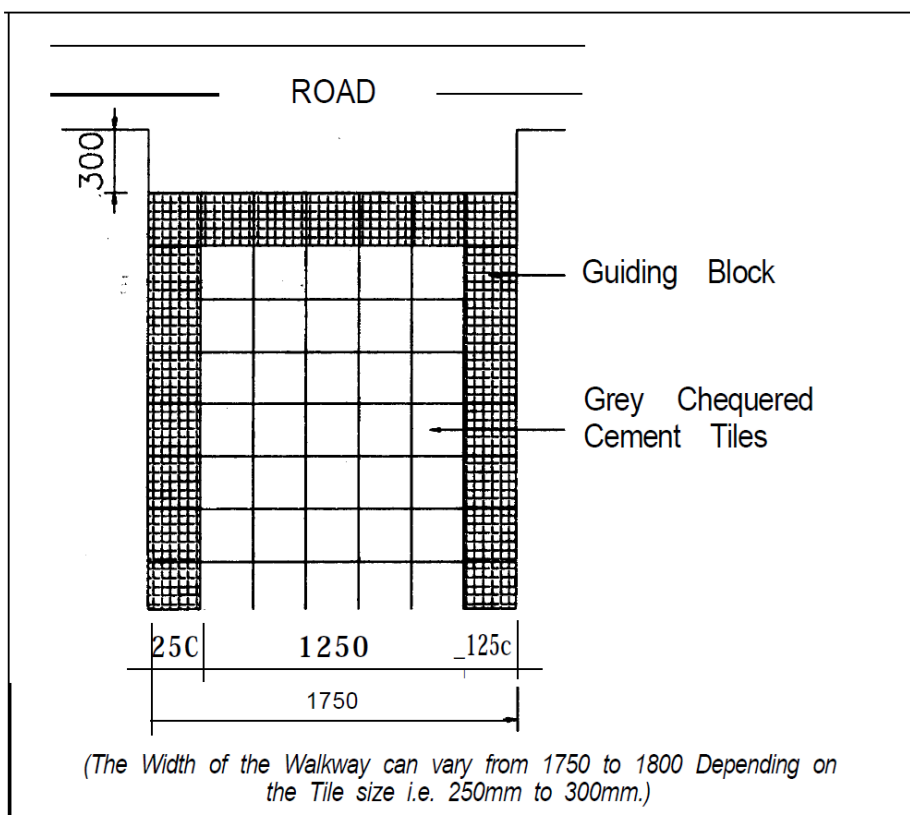

Note :

- Walkway should be constructed with a non-slip material & different from rest of the area.
- The walkway should not cross vehicular traffic.
- The manhole, tree or any other obstructions in the walkway should be avoided.
- Guiding block at the starting of walkway & finishing of the walkway should be provided.
- Guiding block-can be of red chequered tile, smooth rubble finish, prima regina,
- Naveen tiles or any other material with a different texture as compared to the rest of the area.

Guiding/Warning Floor Material

Shapes of guiding blocks for persons with impaired vision

(1) Shape of liner block

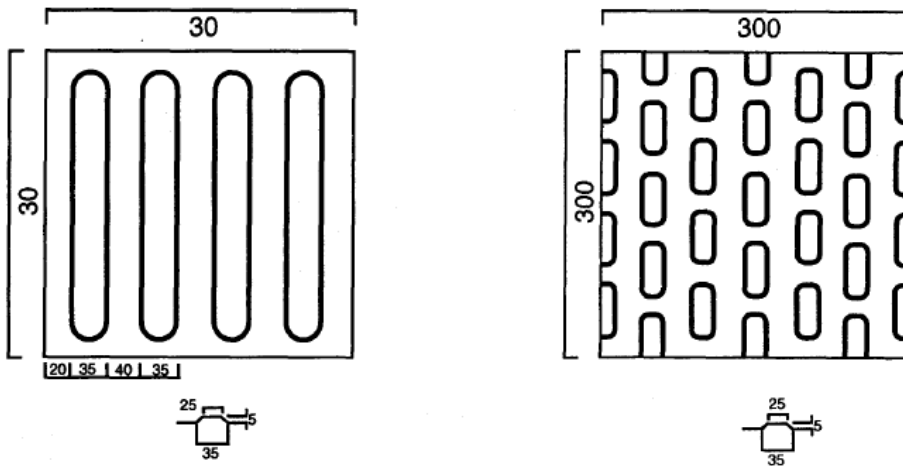

(2) Shape of spot block

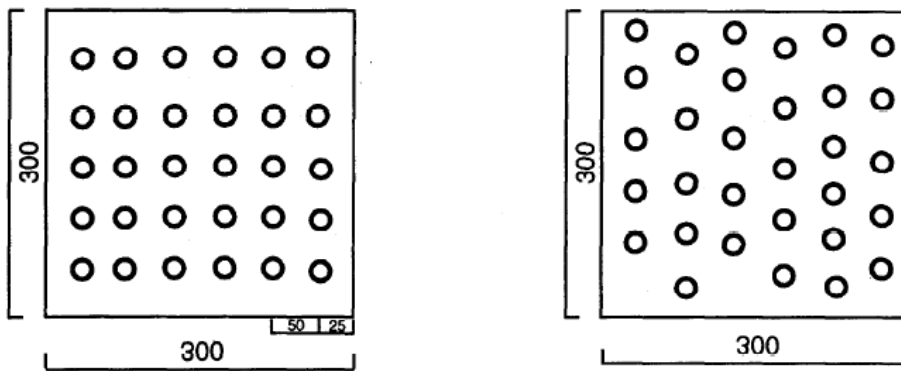

PLACES TO INSTALL GUIDING BLOCKS FOR PERSONS WITH IMPAIRED VISION

- Immediately in front of a location where there is a vehicular traffic.
- Immediately in front of an entrance/exit to and from a staircase or multilevel crossing facility.
- Entrance/exit to and from public transportation terminals, or at boarding areas.
- Sidewalk section of a guiding or approaching road to the building.
- Path from a public facility which is frequently visited by persons with impaired vision (e.g. a city hall or library) to the nearest railroad station (to be installed at intervals)
- Other places where installation of a guiding block for persons with impaired vision is considered effective (e.g. locations abruptly changing in level or ramp).

Example using 30 cm square flooring material

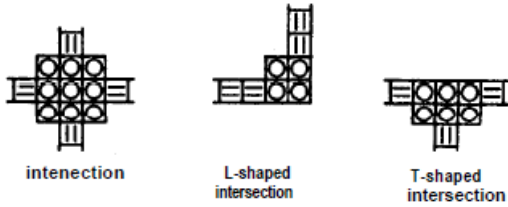

Arrangement of guiding blocks for persons with impaired vision

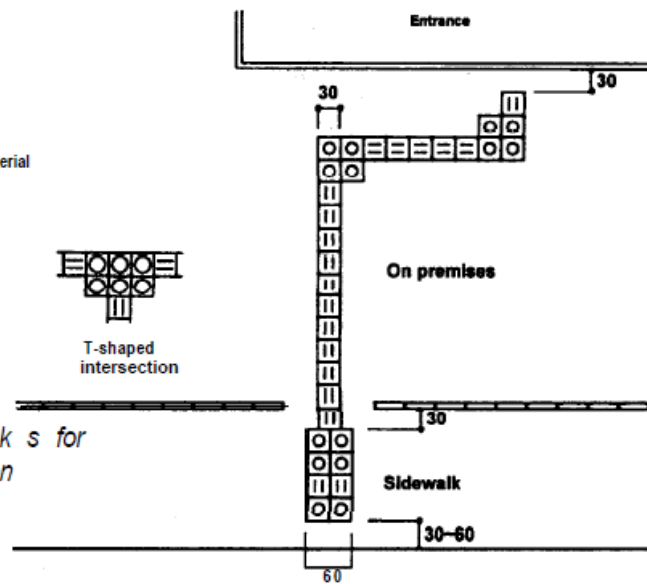

Guiding path and approaching sidewalk to the building

Road Crossing

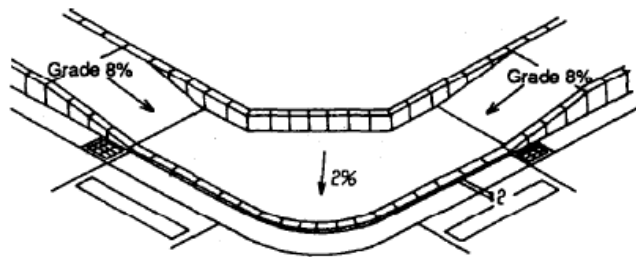
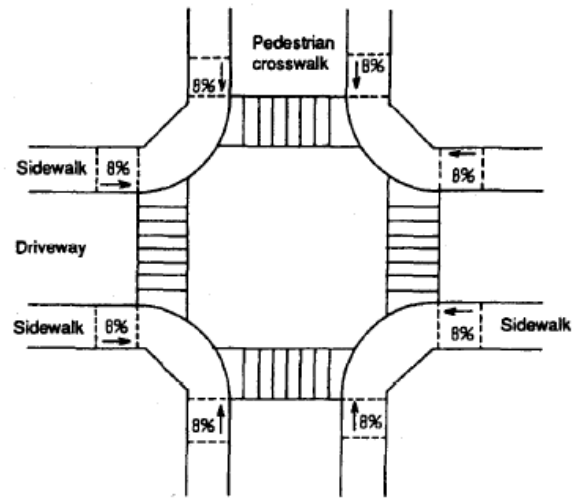
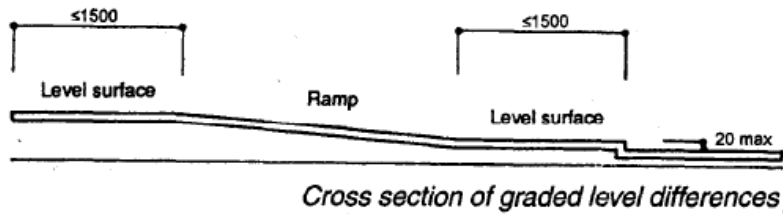

Bus Stops

- Two rows of guiding blocks for persons with impaired vision should be provided 300 mm. away from the bus stop pole on the sidewalk.
- The bus stop pole should be clearly visible after dark.
- The bus stop area should be equipped with a roof and bench.

Example of guiding blocks for persons with impaired vision installed at bus stop

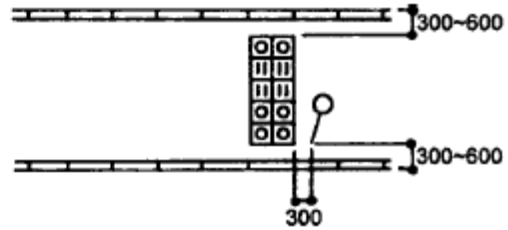

- Information on the names of all stops along a bus route should be indicated inside the bus by displaying text in a suitable position. Preferably, this information should also be announced verbally.
- Information on a route and its final destination should be displayed outside the bus in large text, especially on its front and side. This information should be illuminated by an internal light to make it readable in the dark.

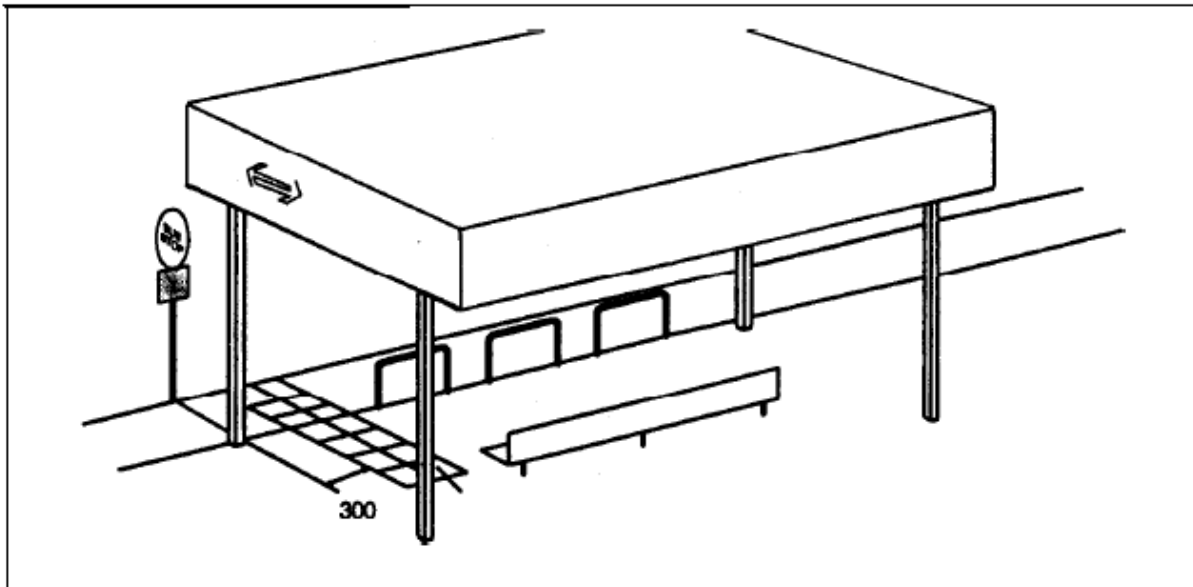

Guiding blocks for persons with impaired vision

SECTION 6
FORM OF BID

FORM OF BID

Description of the Works: Appointment of contractor for development of KalyanMurbad Road from KDMT Bus Depot to Karnik Road as smart street under the network of complete street project under the smart city proposal of Kalyan-Dombivli city

BID

To :

Address

We offer to execute the Works described above and remedy any defects therein in conformity with the conditions of Contract, specification, drawings, Bill of Quantities and Addenda for the sum(s) of

We undertake, if our Bid is accepted, to commence the Works as soon as is reasonably possible after the receipt of the Engineer's notice to commence, and to complete the whole of the Works comprised in the Contract within the time stated in the document.

We agree to abide by this Bid for the period of _____ days from the date fixed for receiving the same, and it shall remain binding upon us and may be accepted at any time before the expiration of that period.

Unless and until a formal Agreement is prepared and executed this Bid, together with your written acceptance thereof, shall constitute a binding contract between us.

We understand that you are not bound to accept the lowest or any tender you may receive.

We accept the appointment of Shri _____ as the Dispute Review Expert.

(OR)

We do not accept the appointment of Shri _____ as the Dispute Review Expert and propose instead that Shri be appointed as Dispute Review Expert, whose BIO-DATA is attached.

Dated this _____ day of _____

Signature _____ in the capacity of _____ duly authorized to sign bids for
and on behalf of _____

(in block capitals or typed)

Address

Witness

Address

Occupation

SECTION 7
BILL OF QUANTITIES

BILL OF QUANTITY

Preamble

1. The Bill of Quantities shall be read in conjunction with the instructions to bidders, conditions of Contract, Technical Specifications and Drawings.
2. The quantities given in the Bill of Quantities are estimated and provisional, and are given to provide a common basis for bidding. The basis of payment will be the actual quantities of work ordered and carried out, as measured by the Contractor and verified by the Engineer and valued at the rates and prices tendered in the priced Bill of Quantities, where applicable, and otherwise at such rates and prices as the Engineer may fix within the terms of the Contract.
3. The rates and prices tendered in the priced Bill of Quantities shall, except in so far as it is otherwise provided under the Contract, include all constructional plant, labour, supervision, materials, erection, maintenance, insurance, profit, taxes and duties, together with all general risks, liabilities and obligations set out or implied in the Contract.
4. The rates and prices shall be quoted entirely in Indian Currency.
5. A rate or price shall be entered against each item in the Bill of Quantities, whether quantities are stated or not. The cost of Items against which the Contractor has failed to enter a rate or price shall be deemed to be covered by other rates and prices entered in the Bill of Quantities.
6. The whole cost of complying with the provisions of the Contract shall be included in the items provided in the priced Bill of Quantities, and where no Items are provided the cost shall be deemed to be distributed among the rates and prices entered for the related Items of Work.
7. General directions and descriptions of work and materials are not necessarily repeated or summarized in the Bill of Quantities. References to the relevant sections of the contract documentation shall be made before entering rates or prices against each item in the Bill of Quantities.
8. The method of measurement of completed work for payment shall be in accordance with the specification for Road and Bridge Works published by the Ministry of Surface Transport (edition).
9. Errors will be corrected by the Employer for any arithmetic errors pursuant to Clause 29 of the Instructions to Bidders.
10. Rock is defined as all materials which, in the opinion of the Engineer, require blasting, or the use of metal wedges and sledgehammers, or the use of compressed air drilling for its removal, and which cannot be extracted by ripping with a tractor of at least 150 kw with a single rear mounted heavy duty ripper.

BILL OF QUANTITIES

Sr. No	Description	Unit	Qty.	Rate (INR) in figures	Rate (INR) in words
1	Providing and fixing retro-reflectorized cautionary, mandatory and informatory sign made of 1.5mm thick Aluminum Sheet/3mm Aluminum Composite Material, face to be fully covered with Class B Type-IV High Intensity Micro Prismatic Grade Sheeting as defined in IRC: 67-2010 having approved messages e.g. letter, numerals, symbols/legend/arrow etc. in Regional and/or Hindi and /or English as per drawing and Technical Specifications for Road and Bridge works (Fourth Revision). The sign plate will be fixed with minimum 6 mm dia aluminum rivets back supported on a mild steel angle iron frame 35x35x5 mm and one vertical Mild Steel post of NB65 Dia Pipe (height from crown level of the road and bottom of the sign board shall not be less than 2.10 m.) firmly fixed to the ground by means of properly designed foundation with M - 15 grade cement concrete 45 cm x 45 cm x 60 cm, 60 cm below ground level as per approved drawing including painting of vertical post as per specification.				
a.	Facility information 650 mm X 900 mm	Nos.	8		
b.	Route marker sign 450mm x 600 mm	Nos.	6		
c.	Triangular 900 mm side	Nos.	4		
2	Providing and laying in situ cement concrete of specified grade of trap / granite /quartzite/ gneiss metal for R.C.C. work for raft, strip foundations, grillage and footings of R.C.C. columns and steel stanchions etc. including bailing out water, formwork, cover blocks compaction and curing etc. (Excluding reinforcement and structural steel) complete, of M30 grade	Cumt	64		
3	Providing and installation of stainless steel bollards of 100 mm dia at the pedestrian refuge islands and pedestrian crossing with excavation, footing. The spacing between the bollards shall be as directed by the Engineer in charge.	Nos	79		

4	Providing and laying Tactile Block of yellow color conforming to IS 13801:1993 (Reaffirmed 1998) of size 250 x 250 x 65 mm on pedestrian pathway as shown in drawing and directed by Eng in charge. The tile should be subjected to a pressure of not less than 14N/sq.mm. Sample must be approved complete as per Additional Technical Specification 10.	Sqmt	132		
5	Providing and fixing heavy duty inter locking concrete Gray / Colour antiskid paving blocks of 80 mm thickness of having a strength of 400 kg/Sq.cm. of approved quality and shape on a bed of crushed sand of 25 to 40 mm thick including compacting cleaning etc. complete. (prior approval of SE is essential) The contractor suitable provisions for ramps with maximum gradient of 8.33% of at all the junctions/crossings to facilitate the movement of differently abled, aged and children.(as shown below) ; and also provide for suitable turning radius as per the proposed layout showed in section 9. Spec. No.: A directed by Engineer in charge	Sqmt	283		
6	Providing and laying in situ Dry lean cement concrete sub-base of trap metal of specified gradation using ,mixing as per approved design mix, compacting with vibratory roller of minimum 80-100KN static weight to give desired compacted density, providing construction joints, and curing with liquid curing compound and sprinkling water, and covering with moist hessian or ponding of water for 7days including all materials,labour,machinery with all leads and lifts, bailing out water manually, and formwork etc. complete..	Cum	27		
	Add for fanning		1.4		
7	Providing Burnt Brick-on-edge in half brick thick wall masonry with second class bricks of conventional type bricks in cement mortar 1:3 including mild steel longitudinal reinforcement of 2 bars of 6mm diameter / one strips of hoop iron 25 mm X 1.6 mm placed at every third course, properly bent and bonded at ends, scaffolding, raking out joints and watering complete.	Sqmt	397		
8	Providing and laying Rough Shahabad Stone Flooring 25-30 mm thick and of required width in plain/ diamond pattern on a bed of 1:6 C.M. including cement float, striking joints, pointing in cement mortar 1:3 curing and cleaning etc. complete.	Sqmt	53		

9	Filling fresh garden soil & manure in excavated area in 3:1 proportion to a required height of 30 cms, mixing garden soil & manure thoroughly well, leveling, watering on previous night. Planting seeding of required annuals 25 cms apart maintaining till well established by watering, weeding, stirring replacing of casualties, etc. complete	Cumt	119		
10	Planting of plants/tress as may be decided by the engineer in charge of polybag size 16 X 16 & height of 6-8 feet	No	26		
11	Procurement and installation of Bus- Q-Shelters of Stainless Steel Confirming to SS 304 Grade , of Span (6.00 X 1.5 M) with SS Vertical Column & Roof Pipe of 219 MM Diameter , Back Rest Pipe & Seating Pipe is of 101 MM Diameter , Add panel of 4.75 X1.5 MTR with clear polycarbonate of 5 MM thick , Roof truss 8 MM thick with multiwall Polycarbonate sheet 10 MM thick (Grey), with proper lighting as specified by the engineer in charge and solar panels. The bus stop shall have LED display boards, fixed or scrolling on the side and the back, wifi connected display for status of the bus of size 1100X400 mm on both sides The contractor shall provide maintenance, including washing and period servicing for a period of 12 months.	No	5		
12	Procurement and installation of galvanized steel, with polyester coating, dual bin system of 70 litres capacity, with sizes as per manufacturer, and recommendations of the engineer in charge. The bins should be openable completely for easy emptying and cleaning, and should have snap locking system. The contractor shall also provide for foundation for the bins of M25 grade concrete. The manufacture should comply with ISO requirements.	Nos	5		
13	Providing & laying in situ RCC including form work Using concrete Mixer of M20 Grade, of trap stone metal for R.C.C. works in cut off walls/curtain walls including necessary scaffolding, centering compacting by vibrator and finishing curing complete. Spec. No.: As directed by Engineer in charge.	Cumt	27		
14	Providing and fixing in position TMT- Fe 500/Fe-415 bar reinforcement of of TATA TISCON /SAIL/JSW /ESSAR or equivalent make (confirming to IS code) of	MT	0.5		

	various diameters for R.C.C. pile caps, footings, foundations, slabs, beams columns, canopies, staircase, newels, chajjas, lintels pardis, copings, fins, arches etc. as per detailed designs, drawings and schedules. including cutting, bending, hooking the bars, binding with wires or tack welding and supporting as required including cover block etc. complete.				
15	Providing second class Burnt Brick masonry with conventional/ I.S. type bricks in cement mortar 1:6 in superstructure including striking joints, racking out joints, watering and scaffolding Complete.	Cumt	53		
16	Providing internal cement plaster 25mm thick in two coats in cement mortar 1:4 without neeru finish, to concrete, brick or stone surfaces, in all positions including scaffolding and curing complete.	Sqmt	106		
17	Providing railing of mild steel post 2 Meter center to center of section 75mm x 75mm x 10mm or equivalent channel section of height 1.05 m above ground surface with minimum anchor length of 30 cm including hold fast of 25 mm diams bar welded at the bottom and concerting of 1:3:6 of size 30 x30 cm with three rows of 40 mm 'B" class G.I. pipes provided at 30 cm centre to centre and including scaffolding and with two coats of anticorrosive paint. etc. complete.	Rmt	265		
18	Providing and laying of hot applied White thermoplastic compound 2.5mm thick, traffic lane edge/centre lines strips 10cm. wide, including reflectorising glass beads @250 gms.persqm area, thickness of 2.5mm is exclusive of surface applied glass beads as per IRC:35. The finished surface to be level, uniform and free from streaks and holes etc.complete with 3 years guarantee	Sqmt	106		
19	Providing and laying of hot applied Yellow thermoplastic compound 2.5mm thick, traffic lane edge/centre lines strips 10cm. wide, including reflectorising glass beads @250 gms.persqm area, thickness of 2.5mm is exclusive of surface applied glass beads as per IRC:35. The finished surface to be level, uniform and free from streaks and holes etc.complete with 3 years guarantee.	Sqmt	106		
20	Providing and painting Zebra painting of pedestrian crossing on the New carriageway with approved road marking paint in two coats etc. complete.(over 10cm.wide patta)	Sqmt	318		
21	Dismantling carefully the structure plain cement concrete, sorting out serviceable materials and stacking, disposing off unserviceable material, up to lead of 50m	Cumt	40		

	etc. Complete				
22	Dismantling carefully the existing structure of Brick masonry, in cement mortar or lime mortar, including sorting out serviceable materials & stacking dismantled materials neatly within 50 Meter lead as directed etc. complete.	Cumt	50		
23	Dismantling carefully reinforced cement concrete including breaking concrete by chiseling wedging, etc. including cutting reinforcement steel bars, sorting out serviceable materials and stacking, disposing off unserviceable material, up to lead of 50m and spreading as directed. etc. Complete.	Cumt	106		
24	Dismantling of flexible pavements and disposal of dismantled materials up to a lead of 1000 Meters, stacking serviceable and unserviceable materials separately with Manual means	Cumt	159		
25	Excavation for the roadway in Earth soil of all sorts sand, gravel or soft murum using manual means including dressing section to the required grade, camber, side slopes and loading in a truck and carrying of cut earth to embankment site with all lifts and lead up to 1000 Meter and spreading for embankment or stacking, disposing as directed by Engineer incharge.	Cumt	53		
26	Debris generated due to dismantling of existing pavement /structures shall be suitably reused in proposed construction. Un-utilizable debris shall be suitably disposed at the site identified by the KDMC. Good disposal practices recommended by various agencies/authorities shall be followed.	Cumt	53		
27	Providing & fixing of Cement Concrete Kerb Stone of various grades of size 600 mm width X 325 mm height X 150 mm thick (half batter, bull nose/full batter) manufactured in wet press vacuum dewatering technology plant/ equivalent with face pimple finish for high visibility with excellent quality and finish and edges perfect and sharp grade M-25 including excavation and any soil except rock, laying a leveling course of M-15 grade RMC 100 mm thick to required slope (Inclusive of formwork) jointing in C.M. 1:2 proportion flush to concrete surface painting exposed surface with one coat of primer and 2 coats of first grade road marking paint in the yellow/white/black or any shade as directed (Kerb Stone shall be procured from KDMC registered agencies and decision of Engineer in charge will be final)	Rmt	636		

28	Providing & fixing 0.91 m X 0.61 m Composite resin Manhole cover with frame (For Footpath) with top coat of decorative granite finish of approved color conforming to relevant grade designation D-2.5 as per IS 1726-1991 and frame shall have rectangular slot for additional grip in concrete with stainless steel wire rope locking arrangement, etc complete, as specified and as directed. (Inspection shall be as per guidelines of IS specifications)	Nos.	8		
29	Supply and installation of Bench With FRP Sitting Slaps of Size Approx 1500L Frame to Frame Side frame is of Cast Iron. Seat & back-rest 1800 long total 10 nos. is of FRP Slap (Rust Proof) of size 65 x 25mm x 1mm thick & it contain inside m.s rectangular tube 50 x 15mm to give it strength including fixing on ground, MS framing, complete with Priming & Synthetic Enamale paint over metallic surfaces in multi colors including cost of all materials, all taxed conveyence to the work site etc. complete.	Nos.	9		
30	Providing and fixing Advertisement board including LED lights inside of the board & all other fixtures in lightning condition without advertisement. Spec. No.: As directed by Engineer in charge as per site condition	Sqmt	41		

Note:

1. Item for which no rate or price has been entered in will not be paid for by the Employer when executed and shall be deemed covered by the other rates and prices in the bill of quantities (Refer : ITB Clause 13.2 and GCC Clause 43.3).
2. Unit rates and prices shall be quoted by the bidder in Indian rupee [ITB Clause 14.11.]
3. Where there is a discrepancy between the rate in figures and words, the rates in words will govern.[ITB Clause 27.1(a)].
4. Where there is a discrepancy between the unit rate and the line item total resulting from multiplying the unit rate by quantity, the unit rate quoted shall govern [ITB Clause 27.1(b)].

SECTION 8
SECURITIES AND OTHER FORMS

PERFORMANCE BANK GUARENTEE

To,

_____ [Name of Employer]
_____ [address of Employer]

WHEREAS _____ [name and address of Contractor] (hereafter called "the Contractor") has undertaken, in pursuance of Contract No. _____ dated _____ to execute [name of Contract and brief description of Works] (hereinafter called "the Contract").

AND WHEREAS it has been stipulated by you in the said Contract that the Contractor shall furnish you with a Bank Guarantee by a recognized bank for the sum specified therein as security for compliance with his obligation in accordance with the Contract;

AND WHEREAS we have agreed to give the Contractor such a Bank Guarantee :

NOW THEREFORE we hereby affirm that we are the Guarantor and responsible to you on behalf of the Contractor, up to a total of _____ [amount of guarantee]¹ (in words), such sum being payable in the types and proportions of currencies in which the Contract Price is payable, and we undertake to pay you, upon your first written demand and without cavil or argument, any sum or sums within the limits of _____ [amount of guarantee] as aforesaid without your needing to prove or to show grounds or reasons for your demand for the sum specified therein.

We hereby waive the necessity of your demanding the said debt from the contractor before presenting us with the demand.

We further agree that no change or addition to or other modification of the terms of the Contract or of the Works to be performed thereunder or of any of the Contract documents which may be made between your and the Contractor shall in any way release us from any liability under this guarantee, and we hereby waive notice of any such change, addition or modification.

This guarantee shall be valid until 28 days from the date of expiry of the Defect Liability Period.

Signature and seal of guarantor _____
Name of the bank _____
Address _____
Date _____

¹An amount shall be inserted by the Guarantor, representing the percentage the Contract Price specified in the Contract including additional security for unbalanced Bids, if any and denominated in Indian Rupees.

LETTER OF ACCEPTANCE

[on letterhead paper of the Employer]

..... [date].

To:[name and address of the Implementing Agency]

Subject:[Notification of Award Contract No].

This is to notify you that your RfP/Bid dated ... [insert date] ... for execution of the . .
..... [insert name of the contract and identification number, as given in the PCC]. . . .
..... for the Accepted Contract Amount of [insert amount in numbers and
words and name of currency], as corrected and modified in accordance with the
Instructions to Bidders is hereby accepted by our Agency.

You are requested to furnish the Performance Security for an amount equivalent to Rs
_____ within 21 (twenty one) days of the receipt of this letter of acceptance valid upto
28 days from the expiry of defects Liability Period, i.e upto _____ and sign the
contract failing which action as stated Para 34.3 of ITB will be taken.

Authorized Signature:

Name and Title of Signatory:

Name of Agency:

Attachment: Contract Agreement

Issue of notice to proceed with the work
(Letterhead of Employer)

_____Date

To

_____ (Name and address of the Contractor)

Dear Sirs,

Pursuant to your furnishing the requisite security as stipulated in ITB Clause 34.1 and signing of the Contract for the construction of

_____ at a Bid Price of Rs. _____

You are hereby instructed to proceed with the execution of the said works in accordance with the contract documents.

Yours faithfully,

(Signature, name and title of signatory authorized to sign on behalf of Employer)

Contract Agreement

THIS AGREEMENT made the day of,, between
.*[name of the Employer]*. (hereinafter “the Employer”), of the one part, and
.*[name of the Implementing Agency]*. (hereinafter “the Implementing Agency”),
of the other part:

WHEREAS the Employer desires that the Works known as*[name of the Contract]*.
. should be executed by the Implementing Agency, and has accepted a Bid by the
Implementing Agency for the execution and completion of these Works and the
remedying of any defects therein,

The Employer and the Implementing Agency agree as follows:

1. In this Agreement words and expressions shall have the same meanings as are respectively assigned to them in the Contract documents referred to.
2. The following documents shall be deemed to form and be read and construed as part of this Agreement. This Agreement shall prevail over all other Contract documents.
 - (i) the Letter of Acceptance
 - (ii) the Letter of Bid
 - (iii) the addenda Nos _____ (if any)
 - (iv) the Particular Conditions
 - (v) the General Conditions of Contract, including appendix;
 - (vi) the Specification
 - (vii) the Drawings
 - (viii) Activity Schedule and
 - (ix) any other document **listed in the PCC** as forming part of the Contract,
3. In consideration of the payments to be made by the Employer to the Implementing Agency as specified in this Agreement, the Implementing Agency hereby covenants with the Employer to execute the Works and to remedy defects therein in conformity in all respects with the provisions of the Contract.
4. The Employer hereby covenants to pay the Implementing Agency in consideration of the execution and completion of the Works and the remedying of defects therein, the Contract Price or such other sum as may become payable under the provisions of the Contract at the times and in the manner prescribed by the Contract.

IN WITNESS whereof the parties hereto have caused this Agreement to be executed in accordance with the laws of *[name of the borrowing country]*. . . .on the day, month and year specified above.

Signed by:

Signed by:

for and on behalf of the Employer

for and on behalf the Implementing Agency

in the presence of: presence of:

Witness, Name, Signature, Address, Date

Witness, Name, Signature, Address, Date

UNDERTAKING

I, the undersigned do hereby undertake that our firm M/s_____agree to abide by this bid for a period days for the date fixed for receiving the same and it shall be binding on us and may be accepted at any time before the expiration of that period.

(Signed by an Authorised Officer
of the Firm)

Title of Officer

SECTION 9
DRAWINGS

